



## Brake Parts Program 2014



# ANNOTATIONS

Commentaires / Commento / Observações / Uwagi / Poznámky



Disc brake pads

Plaquette de frein

Pastiglie freno

Pastilhas de Travão de Disco

Klocki do hamulców tarczowych

Obložení kotoučové brzdy



Brake disc

Disque de frein

Disco freno

Disco de Travão

Tarcza hamulcowa

Brzdový kotouč

## ABBREVIATIONS / ABRÉVIATIONS / ABBREVIAZIONI / ABREVIATURAS / SKRÓTY / ZKRATKY

+	With/only/for	Avec/seulement/pour	Con/solo/per	Com/apenas/para	Z/tylko/do	S/jen/pro
S	Fixing screw/caliper screw	Vis d'étrier/vis de fixation	Viti fissaggio pinza/viti di fissaggio	Parafuso de fixação/parafuso da maxila	Śruba łącząca/śrubą zacisku hamulca	Upevňovací šroub/šroubem třmenu
WD	Warning device	Dispositif d'avertissement	Rilevatore usura incollato	Výstražné zařízení	Urządzenie ostrzegawcze	Výstražné zařízení
WI	Wear indicator	Témoin d'usure	Rilevatore usura a clip	Výstražným kontaktem	Stykem ostrzegawczym	Výstražným kontaktem
ACC	Accessories	Accessoires	Accessori	Príslušenstvím	Osprzętem	Príslušenstvím

**HAND DRIVE / DIRECTION GUIDA / DIRECÇÃO / RODZAJ UKŁADU KIERORWNICZEGO / DRUH FIÍZENÍ**

◀	Left hand drive	Conduite à gauche	Guida a sinistra	Vvolante à esquerda	z kierownicą z lewej strony	Volant vlevo
▶	Right hand drive	Conduite à droite	Guida a destra	Volante à direita	z kierownicą z prawej strony	Volant vpravo

**INSTALLATION POSITION / POSITIONNEMENT / POSIZIONE DI MONTAGGIO / POSICIÓN DE MONTAJE / POZYCJA MONTAŻU / MONTÁŽNÍ POLOHA**

⊕	front	avant	davanti	adelante	z przodu	vpředu
⊖	rear	arrière	dietro	atrás	z tyłu	vzadu
⊗	left	gauche	a sinistra	izquierda	z lewej strony	vlevo
⊙	right	droite	a destra	derecha	z prawej strony	vpravo
⊕	upper left	avant gauche	davanti a sinistra	izquierda adelante	z lewej strony u góry	vlevo nahoře
⊖	lower left	arrière gauche	dietro a sinistra	izquierda atrás	z lewej strony na dole	vlevo dole
⊗	upper right	avant droite	davanti a destra	derecha adelante	z prawej strony u góry	vpravo nahoře
⊙	lower right	arrière droite	dietro a destra	derecha atrás	z prawej strony na dole	vpravo dole
⊠	center	milieu	al centro	medio	po środku	uprostřed
⬆	top	en haut	in alto	arriba	u góry	nahoře
⬇	bottom	en bas	in basso	abajo	na dole	dole
⊠	front axle	essieu avant	asse anteriore	eje delantero	Oś przednia	nahoře
⊠	front left	essieu avant gauche	asse anteriore a sinistra	eje delantero izquierda	z lewej strony z przodu	vlevo nahoře
⊠	front right	essieu avant droite	asse anteriore a destra	eje delantero derecha	z prawej strony z przodu	vpravo nahoře
⊠	rear axle	essieu arrière	asse posteriore	eje trasero	Oś tylna	dole
⊠	rear left	essieu arrière gauche	asse posteriore a sinistra	eje trasero izquierda	z lewej strony z tyłu	vlevo dole
⊠	rear right	essieu arrière droite	asse posteriore a destra	eje trasero derecha	z prawej strony z tyłu	vpravo dole

All position details are based on vehicle facing forwards.

Toutes positions vues en position de conduite.

Le indicazioni dei simboli si riferiscono alla direzione di marcia.

Todas las indicaciones de posición se refieren siempre al sentido de la marcha.

Poszczególne pozycje zawsze w odniesieniu do kierunku jazdy.

Veškeré údaje o pozicích jsou vždy vztaženy na směr jízdy.

**MANUFACTURER / FABRICANT / FABRICANT / FABRICANTE / PRODUCENT / OZNAĀENÍ VÝROBCE**

<b>ATE</b>	Continental Teves (ATE)	<b>BRE</b>	Brembo	<b>MAN</b>	Mando
<b>AKE</b>	Akebono	<b>CIT</b>	Citroën	<b>NIS</b>	Nissin
<b>AIS</b>	Aisin	<b>DEL</b>	Delco	<b>PER</b>	Perrot
<b>AP</b>	AP Lockheed	<b>FI</b>	Fiat	<b>SUM</b>	Sumitomo
<b>BDX</b>	Bendix	<b>FTE</b>	FTE Automotive	<b>TOK</b>	Tokico
<b>BOS</b>	Bosch	<b>LUC</b>	Lucas (TRW)	<b>VW</b>	Volkswagen

Complete copies or extracts of this catalog only by permission. Damage claims on the basis of data in this catalog cannot be recognized. The right of modification in construction or design is reserved. As far as we refer in our documents to part numbers of the vehicle makers, this is for comparison purposes only. The use of such information on invoices to the vehicle owner is not admissible.

The multitude of car models and spare parts from numerous vehicle manufacturers do not always allow an exact allocation. Therefore please pay attention to the corresponding remarks and spare part descriptions.

# TABLE OF CONTENTS

Table des matières / Sommario / Índice / Spis tre'sci / Obsah





<b>VEHICLE APPLICATIONS</b>	<b>1</b>
Applications véhicule / Veicolo Applicazioni / Veículo Aplicações/ Pojazd Aplikacje / Vozidlo Aplikace	
<b>REPLACED PARTS</b>	<b>405</b>
Références remplacées / Codici sostitutivi / Artigos substituídos / Artykuły zastąpione Nahrazené výrobky	
<b>ILLUSTRATIONS DISC BRAKE PADS</b>	<b>411</b>
Illustrations plaquettes de frein à disque Illustrazioni pastiglie freno Figuras Calços do travão de disco Rysunki okładzin hamulców tarczowych Zobrazení obložení kotoučových brzd	
<b>DIMENSIONS BRAKE DISCS</b>	<b>535</b>
Dimensions disques de frein / Misure dischi freno Dimensões dos discos dos travões / Wymiary tarcz hamulcowych Rozměry brzdových kotoučů	
<b>CROSS REFERENCE LIST WVA – GALFER</b>	<b>545</b>
Liste des correspondances WVA – GALFER Tabella di conversione codici WVA – GALFER Lista de comparação WVA – GALFER Lista porównawcza numerów WVA – GALFER Porovnávací seznam čísel WVA – GALFER	
<b>CROSS REFERENCE LIST GALFER – WVA</b>	<b>551</b>
Liste des correspondances GALFER – WVA Tabella di conversione codici GALFER – WVA Lista de comparação GALFER – WVA Lista porównawcza numerów GALFER – WVA Porovnávací seznam čísel GALFER – WVA	
<b>CROSS REFERENCE LIST</b>	<b>557</b>
Liste des correspondances / Tabella di conversione codici Lista de comparação / Lista porównawcza numerów Porovnávací seznam čísel	

# GALFER – A WIN EVERY TIME

Premium brakes at an attractive price



**GALFER brakes are packed full of "stopping power" – in two respects: They provide the outstanding performance of a true premium brake. And they make an immediate impression with compelling prices. Secure your advantage with GALFER in the race for better quality and more customer satisfaction.**

## FORGING AHEAD WITH AUTOMOBILE BRAKES

You may wonder how we achieve premium quality on the road. The answer is quite simple: with double expertise. GALFER has long been a sought-after supplier of original equipment for the automobile industry. Continental has been one of the leading companies in the aftermarket segment for many decades. Together we are now also making the GALFER brand, which has long been established in the OE sector, available to wholesalers and workshops. And in doing so we are providing a range which perfectly meets the challenges you face.

## UNBRAKED INTO THE FUTURE

A good product is one thing; good service is another. To provide the best possible support for you and your business, we deliver our comprehensive product range as quickly as you need it – thanks to efficient and smoothly operating logistics. What is more, our training courses will set you up ideally for the future.

## GALFER ADVANTAGES AT A GLANCE

- Excellent product and service quality with outstanding benefits
- Decades of combined OE and after sales expertise
- Wide product range for many vehicle models and types
- Business-oriented services (e.g. training on new developments)

## TAKE OFF WITH GALFER PREMIUM BRAKES AND LEAVE THE COMPETITION STANDING.

# GALFER – HAS MORE TO OFFER

Wide-ranging guaranteed quality

SURPASSING INTERNATIONAL  
GUIDELINES AND REQUIREMENTS

BRAKE PADS WITH  
UNDER LAYER

AUTOMATED PRODUCTION LINES

ENVIRONMENTALLY FRIENDLY  
COATED BRAKE DISCS

BRAKE PADS WITH  
POSTCURING HEAT TREATMENT

DISC TECHNOLOGY  
WITH HIGH-CARBON ALLOY

## GUARANTEED QUALITY

The market is increasingly demanding attractively priced premium products. Aim for pole position ahead of the competition with GALFER.

**G**ALFER brake pads and discs will impress your customers with their careful machining and perfect assembly of the individual components. With stringent quality control throughout the manufacturing process, we ensure a comfortable ride for the full life of the product. GALFER will help you to satisfy your customers!



### THE ENTIRE RANGE FOR EVERY REQUIREMENT

Our brake components are tailored exactly to meet the demands of drivers, wholesalers and workshops. Right at the product development stage, we ensure that GALFER brake pads and discs are easy to fit, and thereby simplify day-to-day tasks in the workshop.

Our product range covers most vehicle applications. Simply look on our website to find out whether we have the right models for you. Or get in touch with your contact at GALFER directly. He will be pleased to advise you!

**GALFER CAN ASSIST YOU WITH A WIDE PRODUCT PORTFOLIO. WE WILL BE PLEASED TO PROVIDE YOU WITH WHATEVER YOUR CUSTOMERS WANT FROM YOU.**

# GALFER – GETTING IT RIGHT IN EVERY RESPECT

High-quality materials for high-performance braking



**A**s a dealer, you want to offer your workshop customers premium quality products. As a workshop, you want to fit brake pads which are safe and easy to install – regardless of which car you are working on at the time. And we want GALFER to be well accepted by all: by the wholesalers, by the workshops and by the driver. We have therefore developed brake pads to suit all customer groups.

## TECHNOLOGY BRINGS PERFECTION

GALFER brake pads are produced in Europe's most modern lining factory. Their sophisticated mixture of materials guarantees optimum friction characteristics. The pads are even run-in during production. In this way, we ensure that they provide full braking power from the very beginning – even when the brakes get hot on a long downhill stretch. If, however, a product liability situation should arise, our items can be easily traced.

## MUCH BETTER THAN REQUIRED

The statutory requirements for brake pads are strict: according to the European ECE R90 regulation, replacement pads may differ from the original pads by no more than +/- 15%. But at GALFER, we are even stricter. We test all our products in accordance with the OE standard for original equipment manufacturers.

**OUR BRAKE PADS THEREFORE SATISFY EVEN THE HIGHEST SAFETY EXPECTATIONS.**



# GALFER – AND EVERYTHING RUNS SMOOTHLY

High-carbon brake discs for long life



**G**ALFER brake discs provide optimum braking performance throughout their life. This is because we choose the material carefully and process it even more carefully. At the end of the day, we want your customers to be highly satisfied with our products. And we want you to get an all-round good feeling from fitting GALFER brake discs.

## NO TOLERANCE OF QUALITY DEFECTS

GALFER takes quality very seriously, especially where its brake discs are concerned, and allows only the smallest tolerances of no more than 30 µm for disc runout and no more than 10 µm for thickness variation. The tolerances for the centre holes are also so tight that out-of-balance and radial runout are almost non-existent. With agreeable consequences for anyone who uses GALFER brake discs: suspension and wheel bearings are protected, and brake judder and noise are minimised.

## COATED FOR BETTER PROTECTION

In order to guarantee long life, GALFER components are coated with an environmentally compatible material. These coated areas remain free from rust even after fitting.

**THIS MAKES GALFER BRAKE DISCS A REAL EYE CATCHER – ESPECIALLY WITH ALLOY WHEELS.**

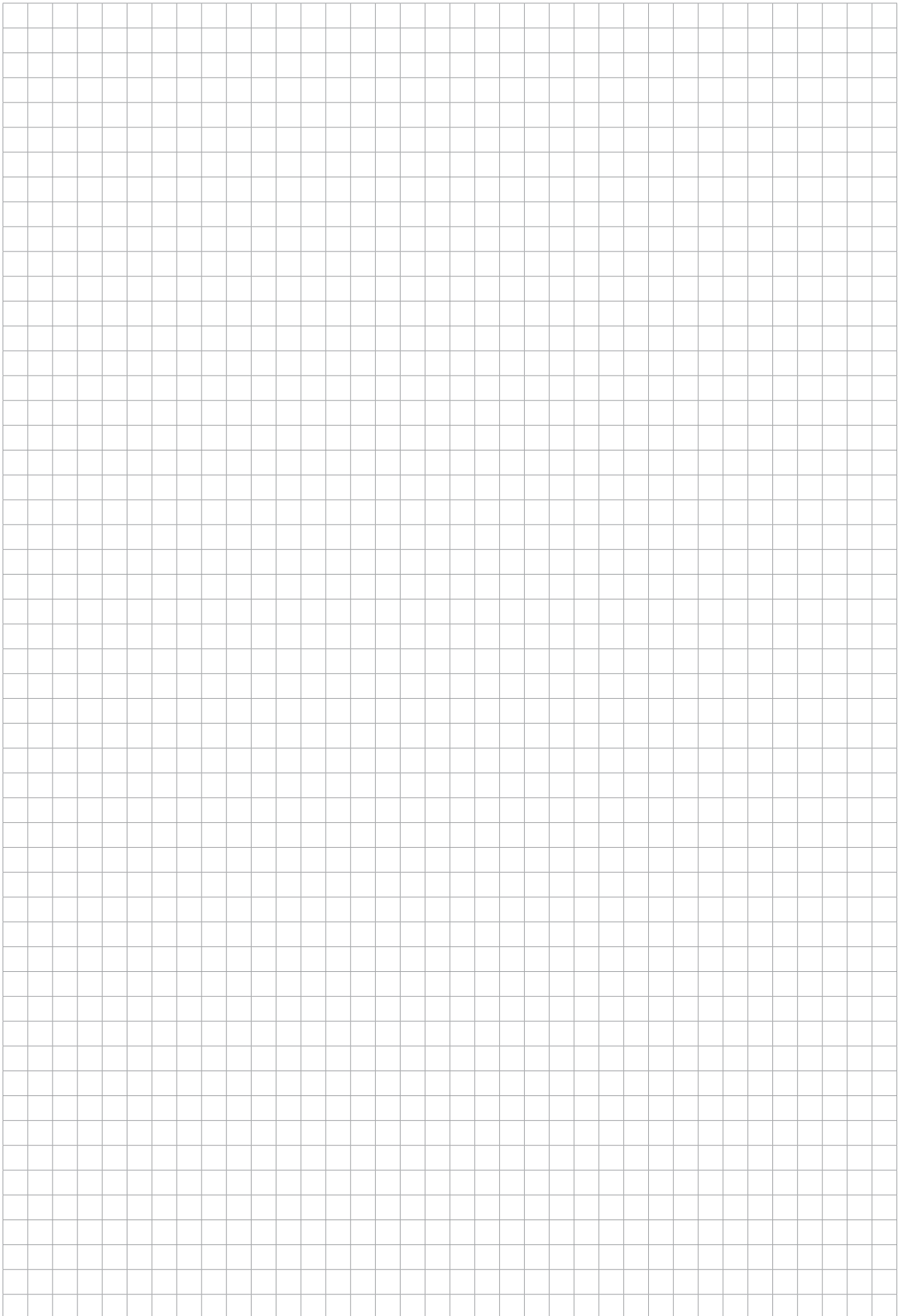

# VEHICLE APPLICATIONS

Applications véhicule / Veicolo Applicazioni

Veículo Aplicações / Pojazd Aplikacje / Vozidlo Aplikace

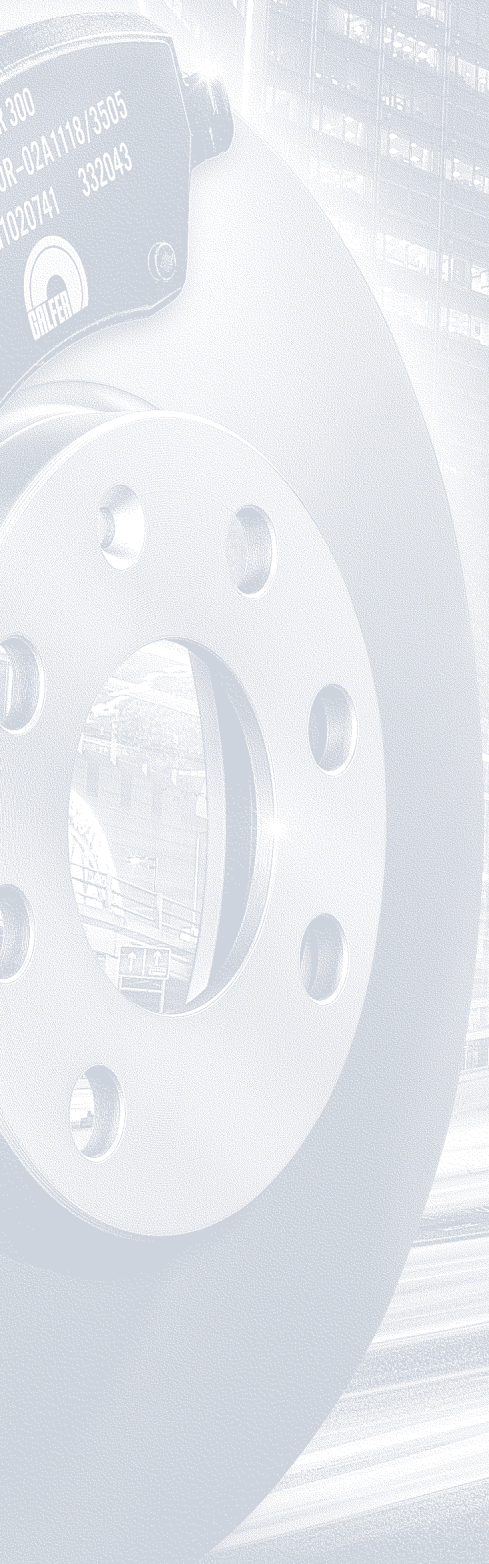









## ROVER

45 series (RT) (00-05)	276
75 series (RJ) (99-04)	276
75 series (RX) (04-05)	276
200 series (XW) (90-95)	276
200 series II (RF) (95-00)	276
400 series (XW) (90-95)	276
400 series (RT) (95-00)	276

## SAAB

9-3 (YS3D) (98-02)	277
9-3 Saloon (YS3F) (03-12)	277
9-3 Sport Estate (05-12)	279
9-3 Convertible (YS3D) (98-03)	280
9-3 Convertible (YS3F) (03-12)	280
9-3 X (09-12)	282
9-5 Saloon (YS3E) (97-10)	282
9-5 Estate (YS3E) (98-10)	283
9-5 II (10-12)	284
900 (94-98)	284

## SEAT

ALHAMBRA I (96-10)	285
ALHAMBRA II (10-)	285
ALTEA (5P1) (04-)	286
ALTEA XL (5P5) (06-)	287
AROSA (6H) (97-05)	289
CORDOBA I (93-99)	289
CORDOBA II (6K2) (99-02)	291
CORDOBA III (6L2) (02-09)	291
EXEO / ST (09-13)	292
IBIZA I (85-92)	293
IBIZA II (93-99)	293
IBIZA III (6K1) (99-02)	295
IBIZA IV (6L1) (02-10)	296
IBIZA V / ST / SPORTCOUPE (08-)	297
INCA (6K9) (96-03)	299
LEON I (1M1) (99-05)	299
LEON II (1P1) (05-12)	301
LEON III (5F) / SC / ST (12-)	304
MALAGA (85-92)	305
MARBELLA (87-98)	305
Mii (12-)	305
TERRA (87-96)	305
TOLEDO I (1L) (91-98)	305
TOLEDO II (1M2) (98-04)	306
TOLEDO III (5P2) (05-09)	308
TOLEDO IV (KG3) (12-)	309

## SKODA

CITIGO (12-)	310
FABIA I (6Y) (99-07)	310
FABIA II (5J) (07-)	310
FAVORIT (781) (87-95)	312
FELICIA I (791/795) (95-97)	312
FELICIA II (6U) (98-01)	312
FELICIA PICK-UP (797) (97-00)	312
FORMAN (785) (91-95)	312
OCTAVIA I (1U) (97-10)	312
OCTAVIA II (1Z) (04-13)	314
OCTAVIA III (6E) (13-)	316
PICK-UP (93-95)	316
RAPID / RAPID Spaceback (12-)	316
ROOMSTER (5J) (06-)	317
SUPERB I (02-08)	318
SUPERB II (08-)	319
SUPERB Estate (09-)	320
YETI (09-)	321

## SMART

CONVERTIBLE (BM450) (00-03)	322
CITY COUPE (BM450) (98-04)	322
CROSSBLADE (BM450) (02-04)	322
FORFOUR (BM454) (04-06)	322
FORTWO CONVERTIBLE (BM450) (04-07)	323
FORTWO COUPE (BM450) (04-07)	323
FORTWO CONVERTIBLE (BM451) (07-)	323
FORTWO COUPE (BM451) (07-)	323
ROADSTER (BM452) (03-05)	323
ROADSTER COUPE (BM452) (03-05)	323

## SUBARU

FORESTER (02-08)	323
FORESTER (08-)	323
IMPREZA Saloon (00-05)	323
IMPREZA Estate (00-05)	324
IMPREZA (08-)	324
JUSTY (G3X) (03-07)	324
JUSTY (07-11)	324
LEGACY (03-09)	324
LEGACY (09-)	324
OUTBACK (03-09)	324



## SUBARU

OUTBACK (09-)	324
TREZIA (11-)	324

## SUZUKI

GRAND VITARA (05-)	324
IGNIS II (03-12)	324
SPLASH (08-)	324
SWIFT II (96-04)	325
SWIFT III (05-10)	325
SX4 (06-)	325
WAGON R+ (00-08)	325

## TOYOTA

AURIS (06-12)	325
AURIS (12-)	325
AVENSIS (03-09)	325
AYGO (05-)	326
CAMRY (01-05)	326
CAMRY (06-)	326
CARINA E (92-97)	326
CELICA (93-99)	326
CELICA (99-05)	326
COROLLA (02-04)	326
COROLLA (04-06)	326
COROLLA (06-)	327
COROLLA VERSO (02-04)	327
COROLLA VERSO (04-09)	327
FJ CRUISER (11-)	327
IQ (09-)	327
LAND CRUISER 70-75 (90-96)	327
LAND CRUISER ESTATE 80 (90-97)	327
LAND CRUISER 90-95 (96-02)	327
LAND CRUISER 120 (03-)	327
LAND CRUISER 150 (10-)	328
MR2 (00-05)	328
PREVIA (05-)	328
PRIUS (00-03)	328
PRIUS (03-09)	328
PRIUS (09-12)	328
PRIUS PLUS (12-)	328
RAV4 III (05-)	328
RAV4 IV (12-)	329
URBAN CRUISER (09-)	329
VERSO (09-)	329
VERSO S (10-)	329
YARIS (99-05)	329
YARIS (06-11)	329
YARIS (11-)	330
YARIS VERSO (99-05)	330

## VOLKSWAGEN

BORA (98-04)	330
CADDY II (96-03)	334
CADDY III (04-)	334
CADDY Pickup (97-02)	336
CC COUPE (11-)	336
CRAFTER (06-)	337
EOS (06-)	337
FOX (05-)	339
GOLF II (84-93)	339
GOLF III (92-97)	341
GOLF III Variant (93-99)	342
GOLF III Convertible (94-02)	343
GOLF IV (98-05)	343
GOLF IV Variant (99-06)	345
GOLF V (03-08)	346
GOLF V Variant (07-09)	349
GOLF VI (08-)	350
GOLF VI Variant (09-)	353
GOLF VI Convertible (11-)	354
GOLF VII (12-)	354
GOLF VII Variant (13-)	355
GOLF Plus (05-)	356
JETTA V (05-10)	358
JETTA VI (11-)	359
LT/LT 4x4 (96-06)	360
Lupo (98-05)	360
NEW BEETLE (98-10)	360
NEW BEETLE Convertible (03-10)	361
BEETLE (11-)	362
BEETLE Convertible (12-)	362
PASSAT (88-93)	363
PASSAT (94-96)	363
PASSAT (97-05)	364
PASSAT Saloon (05-10)	366
PASSAT Variant (05-10)	367
PASSAT CC (08-11)	369
PASSAT / PASSAT VARIANT (10-)	370
PASSAT ALLTRACK (12-)	371
PHAETON (02-)	371
POLO II (81-94)	371
POLO III (95-01)	371
POLO IV (02-09)	372
POLO V (09-)	374
POLO Classic (96-01)	376



## VOLKSWAGEN

POLO Variant (97-01)	376
SCIROCCO (08-)	377
SHARAN I (95-10)	377
SHARAN II (10-)	378
TIGUAN (07-)	378
TOUAREG I (03-10)	379
TOUAREG II (10-)	380
TOURAN (03-)	380
TRANSPORTER (T4) (90-03)	382
TRANSPORTER (T5) BUS / MULTIVAN / KASTEN (03-)	383
TRANSPORTER (T5) PRITSCHKE / FAHRGESTELL (03-)	385
VENTO (92-98)	387
up (11-)	388

## VOLVO

850 Saloon (91-96)	388
850 Estate (92-96)	388
940 I Saloon (90-95)	389
940 I Estate (90-95)	389
940 II Saloon (95-98)	389
940 II Estate (95-98)	389
960 I Saloon (90-94)	389
960 I Estate (90-94)	389
960 II Saloon (94-96)	389
960 II Estate (94-96)	389
C30 Coupe (06-12)	389
C70 Coupe (97-02)	390
C70 I Convertible (98-06)	390
C70 II Convertible (06-13)	390
S40 I (95-03)	391
S40 II (04-12)	392
S60 I (00-09)	393
S60 II (10-)	393
S70 (97-00)	394
S80 I (98-06)	394
S80 II (06-)	395
S90 (97-98)	397
V40 (95-04)	397
V40 (12-)	398
V50 (04-12)	398
V60 (10-)	399
V70 I (97-00)	400
V70 II (00-07)	400
V70 III (07-)	401
V90 (97-98)	403
XC60 (08-)	403
XC70 I CROSS COUNTRY (00-07)	403
XC70 II CROSS COUNTRY (07-)	403
XC90 (02-)	404



**ALFA ROMEO 145 (94-01)**

	1.4 i.e.	66		07.94	12.96	G1020140		20839 17,0 /W/S	LUC				
	1.6 i.e.	76		07.94	12.96								
	1.7 i.e. 16V			07.94	12.96								
	2.0 TD	66		07.94	12.96								
	1.8 i.e. T.Spark			01.97	02.01	G1020360		21636 19,3 +/W/I	ATE				
	2.0 i.e. 16V			10.95	02.01								
	1.4 i.e.	66		07.94	12.96	G2112127		258 12,0 10,2 +C					
	1.6 i.e.	76		07.94	12.96								
	2.0 TD	66		07.94	12.96								
	1.4 i.e. T.Spark	76		01.97	02.01								
	1.6 i.e. T.Spark			01.97	02.01	G2120142		258 20,0 18,2 V L +C					
	1.7 i.e. 16V			07.94	12.96								
	1.9 JTD	77		02.99	02.01								
	2.0 TD	66		01.97	02.99								
	1.4 i.e.	66		07.94	12.96 + ABS					G1020236		21103 14,2 /S	LUC
	1.4 i.e. T.Spark	76		01.97	02.01 + ABS								
		1.6 i.e.	76		07.94					12.96 + ABS	G1020384		23177 14,2 /S
1.6 i.e. T.Spark				01.97	02.01 + ABS								
1.7 i.e. 16V				07.94	12.96								
1.8 i.e. T.Spark				01.97	02.01								
1.9 JTD		77		02.99	02.01 + ABS								
2.0 i.e. 16V				10.95	02.01								
2.0 TD		66		07.94	02.99 + ABS								

**ALFA ROMEO 146 (94-01)**

















	1.4 i.e.	66		12.94	12.96	G1020140		20839 17,0 /W/S	LUC				
	1.6 i.e.	76		12.94	12.96								
	1.7 i.e. 16V			12.94	12.96								
	2.0 TD	66		12.94	12.96								
	1.8 i.e. T.Spark			01.97	02.01	G1020360		21636 19,3 +/W/I	ATE				
	2.0 i.e. 16V			10.95	02.01								
	1.4 i.e.	66		12.94	12.96	G2112127		258 12,0 10,2 +C					
	1.6 i.e.	76		12.94	12.96								
	2.0 TD	66		12.94	12.96								
	1.4 i.e. T.Spark	76		01.97	02.01								
	1.6 i.e. T.Spark			01.97	02.01	G2120142		258 20,0 18,2 V L +C					
	1.7 i.e. 16V			12.94	12.96								
	1.9 JTD	77		02.99	02.01								
	2.0 TD	66		01.97	02.99								
	1.4 i.e.	66		12.94	12.96 + ABS					G1020236		21103 14,2 /S	LUC
	1.4 i.e. T.Spark	76		01.97	02.01 + ABS								
		1.6 i.e.	76		12.94					12.96 + ABS	G1020384		23177 14,2 /S
1.6 i.e. T.Spark				01.97	02.01 + ABS								
1.7 i.e. 16V				12.94	12.96								
1.8 i.e. T.Spark				01.97	02.01								
1.9 JTD		77		02.99	02.01 + ABS								
2.0 i.e. 16V				10.95	02.01								
2.0 TD		66		12.94	02.99 + ABS								

**ALFA ROMEO 147 (01-10)**























	1.6 i 16V T.Spark	77		01.01	VET: - 3021488	G1020500		23140 19,4 +/W/I	ATE
	1.6 i 16V T.Spark	77		10.10	VET: 3021489 -	G1020473		23289 19,3 +/W/I	ATE
	1.6 i 16V T.Spark	88		01.01	10.10				
	1.9 JTD	74		06.03	10.10				
	1.9 JTD	81		11.00	10.10				
	1.9 JTD	85		01.01	10.10				
	1.9 JTD 16V			11.02	10.10				
	1.9 JTDM 16V			07.05	10.10				
	1.9 JTDM 8V	88		07.05	10.10				
	2.0 i 16V T.Spark	110		01.01	10.10				
	1.6 i 16V T.Spark	77		10.10	VET: 3021489 -	G2122145		284 22,0 20,2 V +C	
	1.6 i 16V T.Spark	88		01.01	10.10				
	1.9 JTD	74		06.03	10.10				
	1.9 JTD	81		11.00	10.10				
	1.9 JTD	85		01.01	10.10				
	1.9 JTD 16V			11.02	10.10				
	1.9 JTDM 16V			07.05	10.10				
	1.9 JTDM 8V	88		07.05	10.10				
	2.0 i 16V T.Spark	110		01.01	10.10				
		1.6 i 16V T.Spark	77		01.01				
1.6 i 16V T.Spark		88		01.01	10.10				
1.9 JTD		74		06.03	10.10				
1.9 JTD		81		11.00	10.10				
1.9 JTD		85		01.01	10.10				
1.9 JTD 16V				11.02	10.10				
1.9 JTDM 16V				07.05	10.10				
1.9 JTDM 8V		88		07.05	10.10				
2.0 i 16V T.Spark		110		01.01	10.10				
3.2 GTA		184		02.03	10.10				
	1.6 i 16V T.Spark	77		01.01	10.10	G2110209		251 10,0 9,0 +C	
	1.6 i 16V T.Spark	88		01.01	10.10				
	1.9 JTD	74		06.03	10.10				
	1.9 JTD	81		11.00	10.10				
	1.9 JTD	85		01.01	10.10				
	1.9 JTD 16V			11.02	10.10				

1) + pinza in ghisa / + étriers en fonte grise / + fundición gris-pinza / + GG-Sättel  
 2) + pinze in alluminio / + étriers en aluminium / + pinzas de aluminio / + ALU-Sättel



							
<b>ALFA ROMEO 147 (01-10)</b>							
	1.9 JTDM 16V 1.9 JTDM 8V 2.0 i 16V T.Spark	88 110		07.05 07.05 01.01	10.10 10.10 10.10	G2110209	251 10,0 9,0 +C
<b>ALFA ROMEO 155 (92-97)</b>							
	1.7 T.S. 1.8 T.S. 1.9 TD			04.93 05.92 03.93	12.97 12.97 12.97	G1020140	20839 17,0 /W/S LUC
	1.7 T.S. 1.8 T.S. 1.9 TD 2.5 TD			04.93 05.92 03.93 04.93	12.97 12.97 12.97 12.97	G2120142 G2112127	258 20,0 18,2 V L +C 258 12,0 10,2 +C
	2.0 16V Turbo Q4 2.5 TD 2.5 V6			11.92 03.93 05.92	12.97 12.97 12.97	G2122147	284 22,0 20,2 V +C
	1.7 T.S. 1.8 T.S. 1.9 TD 2.0 16V Turbo Q4 2.0 T.S. 2.5 TD 2.5 V6			04.93 05.92 03.93 11.92 05.92 03.93 05.92	12.97 12.97 12.97 12.97 12.97 12.97 12.97	G1020236 G1020384	+ cast iron caliper <sup>1)</sup> + aluminium calipers <sup>2)</sup> 21103 14,2 /S 23177 14,2 /S LUC
<b>ALFA ROMEO 156 (97-05)</b>							
	1.6 i 16V T.Spark 1.8 i 16V T.Spark 1.9 JTD			10.97 10.97 10.97	02.00 02.00 02.00	G1020392	23140 19,4 +/W/ ATE
	1.6 i 16V T.Spark 1.8 i 16V T.Spark 1.9 JTD			03.00 03.00 03.00	02.01 02.01 02.01	G1020500	23140 19,4 +/W/ ATE
	2.0 16V T.Spark 2.4 JTD 2.5 V6 24V	100		10.97 10.97 10.97	02.00 02.00 02.00	G1020360	21636 19,3 +/W/ ATE
	1.6 i 16V T.Spark 1.8 i 16V T.Spark 1.9 JTD 1.9 JTD 16V 2.0 16V T.Spark 2.0 JTS 2.4 JTD 2.4 JTD 2.5 V6 24V	103 122 100 103		03.01 03.01 03.01 11.02 03.00 03.02 03.00 10.00 03.00	07.05 07.05 07.05 07.05 07.05 07.05 10.00 07.05 07.05	G1020473	23289 19,3 +/W/ ATE
	1.8 i 16V T.Spark 1.9 JTD 16V 2.0 16V T.Spark 2.0 JTS 2.4 JTD 2.4 JTD 2.4 JTD 2.5 V6 24V	103 122 100 103 110 129		10.97 11.02 10.97 03.02 10.97 10.00 03.02 10.97	07.05 07.05 07.05 07.05 07.05 07.05 07.05 07.05	G2122145	284 22,0 20,2 V +C
	1.6 i 16V T.Spark 1.8 i 16V T.Spark 1.9 JTD 2.0 16V T.Spark 2.4 JTD 2.4 JTD 2.5 V6 24V	100 103		10.97 10.97 10.97 10.97 10.00 10.00 10.97	02.02 02.02 02.02 02.02 10.00 02.02 02.02	G1020359	21606 16,7 /S LUC
	1.6 i 16V T.Spark 1.8 i 16V T.Spark 1.9 JTD 1.9 JTD 16V 1.9 JTD 16V 2.0 16V T.Spark 2.0 JTS 2.4 JTD 2.4 JTD 2.4 JTD 2.5 V6 24V 3.2 GTA	103 110 122 103 110 122 103 110 129 184		03.02 03.02 03.02 11.02 07.04 03.02 03.02 03.02 10.03 03.02 03.02	07.05 07.05 07.05 07.05 07.05 07.05 07.05 07.05 07.05 07.05 07.05	G1020568	23517 16,6 /S LUC
	1.6 i 16V T.Spark 1.8 i 16V T.Spark 1.9 JTD 2.0 16V T.Spark 2.4 JTD 2.4 JTD 2.5 V6 24V	100 103		10.97 10.97 10.97 10.97 10.00 10.00 10.97	02.02 02.02 02.02 02.02 10.00 02.02 02.02	G2110209	251 10,0 9,0 +C
<b>ALFA ROMEO 159 (05-11)</b>							
	1.8 MPI 1.9 JTDM 16V 1.9 JTDM 8V 1.9 JTS 2.2 JTS	103 118 136		03.07 06.05 06.05 06.05 06.05	10.11 10.11 10.11 10.11 10.11	G1020701	24339 20,5 +/W/ ATE



















<sup>1)</sup> + pinza in ghisa / + étriers en fonte grise / + fundición gris-pinza / + GG-Sättel  
<sup>2)</sup> + pinze in alluminio / + étriers en aluminium / + pinzas de aluminio / + ALU-Sättel

									
<b>ALFA ROMEO 159 (05-11)</b>									
	1.8 MPI	103		03.07	10.11		G1020572	23760 17,7 /S	LUC
	1.8 TBi	147		05.09	10.11				
	1.9 JTDM 16V			06.05	10.11				
	1.9 JTDM 8V			06.05	10.11				
	1.9 JTS	118		06.05	10.11				
	2.0 JTDM	100		06.10	10.11				
	2.0 JTDM	120		05.09	10.11				
	2.0 JTDM	125		05.09	10.11				
	2.2 JTS	136		06.05	10.11				
	2.4 JTDM 20V	147		06.05	10.11				
	2.4 JTDM 20V	154		05.07	10.11				
	2.4 JTDM 20V Q4	154		05.07	10.11				
	3.2 JTS	191		02.08	10.11				
	3.2 JTS Q4	191		12.05	10.11				
<b>ALFA ROMEO 164 (92-98)</b>									
	2.0 Turbo			09.91	09.98	- series super <sup>1)</sup>	G2122145	284 22,0 20,2 V +C	
	3.0 i V6 Q.V. Q4	171		04.94	09.98		G1020359	21606 16,7 /S	LUC
	2.0 T.Spark			09.91	09.98		G2110190	252 10,0 9,0 +C	
	2.0 Super Turbo			09.91	09.98		G2110209	251 10,0 9,0 +C	
	2.0 Turbo			09.91	09.98	- series super <sup>1)</sup>			
	2.5 TD			09.91	09.98				
	3.0 i 24V Super	155		12.92	09.98				
	3.0 i V6	135		09.91	11.92				
	3.0 i V6	155		12.92	09.98				
	3.0 i V6 Q.V.	147		09.91	11.92				
	3.0 i V6 Q.V.	171		12.92	09.98				
<b>ALFA ROMEO 166 (98-07)</b>									
	2.0 i 16V T.Spark			10.98	12.07		G1020359	21606 16,7 /S	LUC
	2.0 i V6 Turbo			10.98	12.07				
	2.4 JTD	100		10.98	10.00				
	2.4 JTD	103		10.00	12.07				
	2.4 JTD	110		04.02	12.07				
	2.4 JTD	120		10.03	12.07				
	2.4 JTD	129		10.03	12.07				
	2.4 JTD	132		07.06	12.07				
	2.4 JTD	136		07.05	12.07				
	2.5 i V6			10.98	12.07				
	3.0 i V6			10.98	12.07				
	3.2 i V6			10.03	12.07				
<b>ALFA ROMEO BRERA (06-11)</b>									
	2.2 JTS	136		12.05	09.11		G1020701	24339 20,5 +/WI	ATE
	1.8 TBi	147		05.09	09.11		G1020572	23760 17,7 /S	LUC
	2.0 JTDM	125		05.09	09.11				
	2.2 JTS	136		12.05	09.11				
	2.4 JTDM 20V	147		12.05	09.11				
	2.4 JTDM 20V	154		02.07	09.11				
	3.2 JTS	191		03.08	09.11				
	3.2 JTS Q4	191		12.05	09.11				
<b>ALFA ROMEO GT (04-10)</b>									
	1.8 TS	103 3286798			07.10		G1020473	23289 19,3 +/WI	ATE
	1.9 JTD	110 3286798			07.10				
	1.9 JTD	125		05.08	07.10				
	2.0 JTS	121 3286798			07.10				
	1.8 TS	103		11.03	07.10		G2122145	284 22,0 20,2 V +C	
	1.9 JTD	110		11.03	07.10				
	1.9 JTD	125		05.08	07.10				
	2.0 JTS	121		11.03	07.10				
	1.8 TS	103		11.03	07.10		G1020568	23517 16,6 /S	LUC
	1.9 JTD	110		11.03	07.10				
	1.9 JTD	125		05.08	07.10				
	2.0 JTS	121		11.03	07.10				
	3.2 i V6	176		11.03	07.10				
<b>ALFA ROMEO GTV (95-05)</b>									
	1.8 i 16V	106		04.98	12.05		G1020360	21636 19,3 +/WI	ATE
	2.0 i 16V			07.95	12.05				
	2.0 i V6 Turbo	148		07.95	12.05				
	2.0 JTS	121		04.03	12.05				
	2.0 i V6 Turbo	148		05.95	12.05		G2122145	284 22,0 20,2 V +C	
	1.8 i 16V	106		04.98	12.05		G1020236	21103 14,2 /S	LUC
	2.0 i 16V			05.95	12.05		G1020384	23177 14,2 /S	LUC
	2.0 i V6 Turbo	148		05.95	12.05				
	2.0 JTS	121		04.03	12.05				
	3.0 i V6			10.96	12.05				

<sup>1)</sup> - serie super / - Série super / - serie súper / - Serie Super

<sup>2)</sup> + pinza in ghisa / + étriers en fonte grise / + fundición gris-pinza / + GG-Sättel

<sup>3)</sup> + pinze in alluminio / + étriers en aluminium / + pinzas de aluminio / + ALU-Sättel





















									
<b>ALFA ROMEO GTV (95-05)</b>									
	3.2 i V6	176		04.03	12.05	G1020236 G1020384	+ cast iron caliper <sup>1)</sup> + aluminium calipers <sup>2)</sup>	21103 14,2 /S 23177 14,2 /S	LUC LUC
<b>ALFA ROMEO MITO (08-)</b>									
	0.9	63		07.11		G1201224		23706 18,0 +/W/Acc/S	BOS
	0.9	77		04.13					
	1.4 i 16V	51		05.11		G1020737		23706 18,0 +/W/Acc/S	BOS
	1.4 i 16V	58		08.08					
	1.4 i 16V	70		08.08					
	1.3 JTDM	62		01.11		G1020504		23711 19,4 +/W/S	BOS
	1.3 JTDM	66		08.08					
	1.3 JTDM	70		10.09					
	1.4	88		08.08					
	1.4 Bifuel	88		07.11					
	1.4 TB	99		09.09					
	1.6 JTD	88		08.08					
	1.6 JTDM	85		09.08					
	0.9	63		07.11		G2122197		258 22,0 20,2 V +C	
	0.9	77		04.13					
	1.4 i 16V	51		05.11					
	1.4 i 16V	58		08.08					
	1.4 i 16V	70		08.08					
	0.9	63		07.11		G1020515 G1021128	+ special brake caliper <sup>3)</sup> + special brake caliper <sup>3)</sup>	23714 16,6 /S 23714 17,6 +/W/Acc/S	BOS BOS
	0.9	77		04.13					
	1.3 JTDM	62		01.11					
	1.3 JTDM	66		08.08					
	1.3 JTDM	70		10.09					
	1.4	88		08.08					
	1.4 Bifuel	88		07.11					
	1.4 i 16V	51		05.11					
	1.4 i 16V	58		08.08					
	1.4 i 16V	70		08.08					
	1.4 TB	99		09.09					
	1.4 TB	114		08.08					
	1.4 TB	125		10.09					
	1.4 Turbo	110		09.08					
	1.6 JTD	88		08.08					
	1.6 JTDM	85		09.09					
<b>ALFA ROMEO SPIDER (95-05)</b>									
	1.8 i 16V	106		04.98	12.05	G1020360		21636 19,3 +/W/	ATE
	2.0 16V	114		05.98	12.05				
	2.0 i 16V	110		11.95	12.05				
	2.0 i V6 Turbo	148		05.98	12.05				
	2.0 JTS	121		04.03	12.05				
	2.0 i V6 Turbo	148		05.98	12.05	G2122145		284 22,0 20,2 V +C	
	1.8 i 16V	106		04.98	12.05	G1020236 G1020384	+ cast iron caliper <sup>1)</sup> + aluminium calipers <sup>2)</sup>	21103 14,2 /S 23177 14,2 /S	LUC LUC
	2.0 16V	114		05.98	12.05				
	2.0 i 16V	110		05.95	12.05				
	2.0 i V6 Turbo	148		05.98	12.05				
	2.0 JTS	121		04.03	12.05				
	3.0 i V6	141		05.95	12.05				
	3.0 V6	160		10.00	12.05				
	3.0 V6 24V	162		01.99	12.05				
	3.2 i V6	176		04.03	12.05				
<b>ALFA ROMEO SPIDER (06-11)</b>									
	2.2 JTS	136		04.06	02.08	G1020701		24339 20,5 +/W/	ATE
	1.8 TBi	147		05.09	09.11	G1020572		23760 17,7 /S	LUC
	2.0 JTDM	120		04.09	09.11				
	2.0 JTDM	125		05.09	09.11				
	2.2 JTS	136		04.06	09.11				
	2.4 JTDM 20V	147		02.07	09.11				
	2.4 JTDM 20V	154		05.07	09.11				
	3.2 JTS	191		03.08	09.11				
	3.2 JTS Q4	191		04.06	09.11				
<b>AUDI 80 (91-95)</b>									
	1.6			08.91	12.95	G1020196 G1020197		20669 19,0 /S 20901 19,0 +/W/S	LUC LUC
	1.9 TD	55		09.91	12.95				
	1.9 TDI	66		09.91	12.95				
	2.0			08.91	12.95				
	2.3			09.91	12.95				
	2.6			07.92	12.95				
	1.6		8C-P-050000	08.91		G1020246	+ ABS	21144 15,8 /S	LUC
	1.6		8C-P-050001	12.95			+ ABS		
	1.9 TD	55	8C-P-050001	09.91			+ ABS		
	1.9 TD	55	8C-P-050001	12.95			+ ABS		
	1.9 TDI	66	8C-P-050000	09.91			+ ABS		
	1.9 TDI	66	8C-P-050001	12.95			+ ABS		
	2.0	66	8C-P-050000	08.91			+ ABS		

<sup>1)</sup> + pinza in ghisa / + étriers en fonte grise / + fundición gris-pinza / + GG-Sättel

<sup>2)</sup> + pinze in alluminio / + étriers en aluminium / + pinzas de aluminio / + ALU-Sättel

<sup>3)</sup> + pinza freno speciale / + pince à frein spéciale / + pinza freno especial / + Sonderbremszange

<b>AUDI 80 (91-95)</b>																				
	2.0 2.0 2.0 2.0 2.3 2.6 2.8	66 85 101 103	8C-P-050001		08.91 08.91 08.91 09.91 08.92 09.91	12.95 12.95 07.92 12.95 12.95 12.95				G1020246							21144 15,8 /S	LUC		
	1.6 1.6 1.9 TD 1.9 TD 1.9 TDI 1.9 TDI 2.0 2.0 2.0 2.0 2.3 2.6 2.8		8C-P-050001 55 55 66 66 66	8C-P-050000 8C-P-050001 8C-P-050001 8C-P-050000 8C-P-050000	08.91 09.91 09.91 08.91	+ ABS + ABS + ABS + ABS				G2110178							245 10,0 8,0 +C			
<b>AUDI 80 Quattro (92-95)</b>																				
	2.0 2.3 2.6				09.91 09.91 08.92	12.95 12.95 12.95				G1020196							20669 19,0 /S	LUC		
	2.0 2.3 2.6 2.8 S2 2.2				09.91 09.91 08.92 09.91 02.93	12.95 12.95 12.95 12.95 12.95				G1020246							21144 15,8 /S	LUC		
	S2 2.2	169			02.93	12.95				G2110261							245 10,0 8,0 +C			
<b>AUDI 100 (91-94)</b>																				
	1.6 2.0 2.0 16V 2.3 2.4 D 2.5 TDI 2.6 2.8				03.92 12.90 01.92 12.90 05.91 06.91 04.92 12.90	07.93 07.94 07.94 07.94 07.94 07.94 07.94 07.94				G1020311							20678 19,5 +/Wl	ATE		
	1.6 2.0 2.0 16V 2.3 2.4 D 2.5 TDI				03.92 12.90 01.92 12.90 05.91 06.91	07.93 07.94 07.94 07.94 07.94 07.94				G2115105							288 15,0 13,0 L +C			
	2.6 2.8				04.92 12.90	07.94 07.94				G2125105							288 25,0 23,0 V L +C			
	1.6 2.0 2.0 2.0 16V 2.3 2.4 D 2.4 D 2.5 TDI 2.6 2.8				03.92 07.93 12.90 01.92 12.90 07.93 05.91 06.91 04.92 12.90	07.93 07.94 06.93 07.94 07.94 07.94 06.93 07.94 07.94 07.94	+ ABS + ABS			G1020246							21144 15,8 /S	LUC		
	1.6 2.0 2.0 2.0 16V 2.3 2.4 D 2.4 D 2.5 TDI 2.6 2.8				03.92 07.93 12.90 01.92 12.90 07.93 05.91 06.91 04.92 12.90	07.93 07.94 06.93 07.94 07.94 07.94 06.93 07.94 07.94 07.94	+ ABS + ABS			G2110201							245 10,0 8,0 +C			
<b>AUDI 100 quattro (91-94)</b>																				
	2.0 2.3 2.6 2.8				12.90 12.90 03.92 12.90	07.94 07.94 07.94 07.94				G1020311							20678 19,5 +/Wl	ATE		
	2.0 2.3				12.90 12.90	07.94 07.94				G2115105							288 15,0 13,0 L +C			
	2.6 2.8				03.92 12.90	07.94 07.94				G2125105							288 25,0 23,0 V L +C			

								
<b>AUDI 100 quattro (91-94)</b>								
	2.0 2.3 2.6 2.8 S4 2.2 S4 4.2	169	12.90 12.90 03.92 07.92 08.91 10.92	07.94 07.94 07.94 07.94 07.94 07.94		G1020246		21144 15,8 /S LUC
	2.0 2.3 2.6 2.8		12.90 12.90 03.92 12.90	07.94 07.94 07.94 07.94	- (N) - (N) - (N) - (N)	G2110201		245 10,0 8,0 +C
<b>AUDI A1 / A1 Sportback (10-)</b>								
	1.2 TFSI 1.4 TFSI 1.4 TFSI 1.4 TFSI 1.6 TDI 1.6 TDI 2.0 TDI 2.0 TFSI quattro	63 90 103 136 66 77 105 188	05.10 05.10 04.12 11.10 05.10 05.10 09.11 10.12	PR: 1ZG PR: 1ZG PR: 1ZG PR: 1ZG PR: 1ZG PR: 1ZG PR: 1ZG PR: 1ZG		G1020331		23130 19,7 + VW
	1.2 TFSI 1.4 TFSI 1.4 TFSI 1.4 TFSI 1.6 TDI 1.6 TDI 2.0 TDI 2.0 TFSI quattro	63 90 103 136 66 77 105 188	05.10 05.10 04.12 11.10 05.10 05.10 09.11 10.12	PR: 1ZC PR: 1ZC PR: 1ZC PR: 1ZC PR: 1ZC PR: 1ZC PR: 1ZC PR: 1ZC		G1020680		23587 20,6 +/WI ATE
	1.2 TFSI 1.4 TFSI 1.4 TFSI 1.4 TFSI 1.6 TDI 1.6 TDI 2.0 TDI 2.0 TFSI quattro	63 90 103 136 66 77 105 188	05.10 05.10 04.12 11.10 05.10 05.10 09.11 10.12	PR: 1ZG PR: 1ZG PR: 1ZG PR: 1ZG PR: 1ZG PR: 1ZG PR: 1ZG PR: 1ZG		G2122151		256 22,0 19,0 V L +S +C
	1.2 TFSI 1.4 TFSI 1.4 TFSI 1.4 TFSI 1.6 TDI 1.6 TDI 2.0 TDI 2.0 TFSI quattro	63 90 103 136 66 77 105 188	05.10 05.10 04.12 11.10 05.10 05.10 09.11 10.12	PR: 1ZS PR: 1ZS PR: 1ZS PR: 1ZS PR: 1ZS PR: 1ZS PR: 1ZS PR: 1ZS		G2125123		310 25,0 22,0 V L +C
	1.2 TFSI 1.4 TFSI 1.4 TFSI 1.4 TFSI 1.6 TDI 1.6 TDI 2.0 TDI 2.0 TFSI quattro	63 90 103 136 66 77 105 188	05.10 05.10 04.12 11.10 05.10 05.10 09.11 10.12	PR: 1ZC PR: 1ZC PR: 1ZC PR: 1ZC PR: 1ZC PR: 1ZC PR: 1ZC PR: 1ZC		G2125113		288 25,0 22,0 V L +S +C
	1.2 TFSI 1.4 TFSI 1.4 TFSI 1.4 TFSI 1.6 TDI 1.6 TDI 2.0 TDI 2.0 TFSI quattro	63 90 103 136 66 77 105 188	05.10 05.10 04.12 11.10 05.10 05.10 09.11 10.12	PR: 1LJ PR: 1LJ PR: 1LJ PR: 1LJ PR: 1LJ PR: 1LJ PR: 1LJ PR: 1LJ		G2125158		312 25,0 22,0 V L +S +C
	1.2 TFSI 1.4 TFSI 1.4 TFSI 1.4 TFSI 1.6 TDI 1.6 TDI 2.0 TDI 2.0 TFSI quattro	63 90 103 136 66 77 105 188	05.10 05.10 04.12 11.10 05.10 05.10 09.11 10.12	PR: 1KT PR: 1KT PR: 1KT PR: 1KT PR: 1KT PR: 1KT PR: 1KT PR: 1KT		G1020492		23554 17,1 /WD/S LUC
	1.2 TFSI 1.4 TFSI 1.4 TFSI 1.4 TFSI 1.6 TDI 1.6 TDI 2.0 TDI 2.0 TFSI quattro	63 90 103 136 66 77 105 188	05.10 05.10 04.12 11.10 05.10 05.10 09.11 10.12	PR: 1KT PR: 1KT PR: 1KT PR: 1KT PR: 1KT PR: 1KT PR: 1KT PR: 1KT		G2109123		230 9,0 7,0 +S +C
	1.2 TFSI 1.4 TFSI 1.4 TFSI 1.4 TFSI 1.6 TDI 1.6 TDI 2.0 TDI 2.0 TFSI quattro	63 90 103 136 66 77 105 188	05.10 05.10 04.12 11.10 05.10 05.10 09.11 10.12	PR: 1KS PR: 1KS PR: 1KS PR: 1KS PR: 1KS PR: 1KS PR: 1KS PR: 1KS		G2110356		272 9,7 8,0 +S +C



AUDI A2 (00-05)											
	1.4	55		06.00	07.05			G1020463		23131 19,7 +/WI	VW
	1.4 TDI	55		06.00	07.05						
	1.4 TDI	66		11.03	07.05						
	1.6 FSI	81		05.02	07.05						
	1.4	55		06.00	07.05			G2122151		256 22,0 19,0 V L +S +C	
	1.4 TDI	55		06.00	07.05						
	1.4 TDI	66		11.03	07.05						
	1.6 FSI	81		05.02	07.05						
	1.4 TDI	66		11.03	07.05			G1020755		20961 17,1 /Acc/S	LUC
	1.6 FSI	81		05.02	07.05			G1020549		20961 17,1 /WD/S	LUC
	1.4 TDI	66		11.03	07.05			G2109123		230 9,0 7,0 +S +C	
	1.6 FSI	81		05.02	07.05						

AUDI A3 (96-03)											
	1.6	75	8L-X-200000	09.96		PR: 1LQ,1LR,1LS		G1020331		23130 19,7 +	VW
	1.8	92	8L-X-200000	09.96		PR: 1LQ,1LR,1LS					
	1.8 quattro	92	8L-X-200000	08.98		PR: 1LQ,1LR,1LS					
	1.8 T	110	8L-X-200000	12.96		PR: 1LQ,1LR,1LS					
	1.8 T	132	8L-X-200000	12.98		PR: 1LQ,1LR,1LS					
	1.8 T quattro	110	8L-X-200000	08.98		PR: 1LQ,1LR,1LS					
	1.8 T quattro	132	8L-X-200000	10.98		PR: 1LQ,1LR,1LS					
	1.9 TDI	66	8L-X-200000	09.96		PR: 1LQ,1LR,1LS					
	1.9 TDI	81	8L-X-200000	03.97		PR: 1LQ,1LR,1LS					
	1.6	75	8L-Y-000001	06.03	PR: 1LQ,1LS			G1020463		23131 19,7 +/WI	VW
	1.8	92	8L-Y-000001	06.03	PR: 1LQ,1LS						
	1.8 quattro	92	8L-Y-000001	06.03	PR: 1LQ,1LS						
	1.8 T	110	8L-Y-000001	06.03	PR: 1LQ,1LS						
	1.8 T	132	8L-Y-000001	06.03	PR: 1LQ,1LS						
	1.8 T quattro	110	8L-Y-000001	06.03	PR: 1LQ,1LS						
	1.8 T quattro	132	8L-Y-000001	06.03	PR: 1LQ,1LS						
	1.9 TDI	66	8L-Y-000001	06.01	PR: 1LQ,1LS						
	1.9 TDI	74		09.00	06.03	PR: 1LQ,1LS					
	1.9 TDI	81	8L-Y-000001	06.01	PR: 1LQ,1LS						
	1.9 TDI	96		09.00	06.03	PR: 1LQ,1LS					
	1.9 TDI quattro	96		09.00	06.03	PR: 1LQ,1LS					
	1.6	75		09.96	06.03	PR: 12P		G1020463		23131 19,7 +/WI	VW
	1.8	92		09.96	06.03	PR: 12P					
	1.8 quattro	92		08.98	06.03	PR: 12P					
	1.8 T	110		12.96	06.03	PR: 12P					
	1.8 T	132		12.98	06.03	PR: 12P					
	1.8 T quattro	110		08.98	06.03	PR: 12P					
	1.8 T quattro	132		10.98	06.03	PR: 12P					
	1.9 TDI	66		09.96	06.01	PR: 12P					
	1.9 TDI	74		09.00	06.03	PR: 12P					
	1.9 TDI	81		03.97	06.01	PR: 12P					
	1.9 TDI	96		09.00	06.03	PR: 12P					
	1.9 TDI quattro	96		09.00	06.03	PR: 12P					
	1.6	75	8L-X-150000	09.96		PR: 1LE,1LN,1ZD		G1020379		21911 20,3 +	ATE
	1.8	92	8L-X-150000	09.96		PR: 1LE,1LN,1ZD					
	1.8 quattro	92	8L-X-150000	08.98		PR: 1LE,1LN,1ZD					
	1.8 T	110	8L-X-150000	12.96		PR: 1LE,1LN,1ZD					
	1.8 T	132	8L-X-150000	12.98		PR: 1LE,1LN,1ZD					
	1.8 T quattro	110	8L-X-150000	08.98		PR: 1LE,1LN,1ZD					
	1.8 T quattro	132	8L-X-150000	10.98		PR: 1LE,1LN,1ZD					
	1.9 TDI	66	8L-X-150000	09.96		PR: 1LE,1LN,1ZD					
	1.9 TDI	81	8L-X-150000	03.97		PR: 1LE,1LN,1ZD					
	S3 quattro		8L-X-200000	08.98		PR: 1LT					
	1.6	75	8L-Y-000001	06.03	PR: 1LE,1LN,1ZD			G1020512		23392 20,3 +/WI	ATE
	1.8	92	8L-Y-000001	06.03	PR: 1LE,1LN,1ZD						
	1.8 quattro	92	8L-Y-000001	06.03	PR: 1LE,1LN,1ZD						
	1.8 T	110	8L-Y-000001	06.03	PR: 1LE,1LN,1ZD						
	1.8 T	132	8L-Y-000001	06.03	PR: 1LE,1LN,1ZD						
	1.8 T quattro	110	8L-Y-000001	06.03	PR: 1LE,1LN,1ZD						
	1.8 T quattro	132	8L-Y-000001	06.03	PR: 1LE,1LN,1ZD						
	1.9 TDI	66	8L-Y-000001	06.01	PR: 1LE,1LN,1ZD						
	1.9 TDI	74		09.00	06.03	PR: 1LE,1LN,1ZD					
	1.9 TDI	81	8L-Y-000001	06.01	PR: 1LE,1LN,1ZD						
	1.9 TDI	96		09.00	06.03	PR: 1LE,1LN,1ZD					
	1.9 TDI quattro	96		09.00	06.03	PR: 1LE,1LN,1ZD					
	S3 quattro		8L-Y-000001	06.03	PR: 1LT						
	1.6	75		09.96	06.03	PR: 1LQ		G2122151		256 22,0 19,0 V L +S +C	
	1.8	92		09.96	06.03	PR: 1LQ					
	1.8 quattro	92		08.98	06.03	PR: 1LQ					
	1.8 T	110		12.96	06.03	PR: 1LQ					
	1.8 T	132		12.98	06.03	PR: 1LQ					
	1.8 T quattro	110		08.98	06.03	PR: 1LQ					
	1.8 T quattro	132		10.98	06.03	PR: 1LQ					
	1.9 TDI	66		09.96	06.01	PR: 1LQ					
	1.9 TDI	74		09.00	06.03	PR: 1LQ					
	1.9 TDI	81		03.97	06.01	PR: 1LQ					
	1.9 TDI	96		09.00	06.03	PR: 1LQ					
	1.9 TDI quattro	96		09.00	06.03	PR: 1LQ					
	1.6	75		09.96	06.03	PR: 1LR,1LS,1ZP		G2122150		280 22,0 19,0 V L +S +C	
	1.8	92		09.96	06.03	PR: 1LR,1LS,1ZP					



### AUDI A3 (96-03)

	1.8 quattro	92		08.98	06.03	PR: 1LR,1LS,1ZP	G2122150		280 22,0 19,0 V L +S +C	
	1.8 T	110		12.96	06.03	PR: 1LR,1LS,1ZP				
	1.8 T	132		12.98	06.03	PR: 1LR,1LS,1ZP				
	1.8 T quattro	110		08.98	06.03	PR: 1LR,1LS,1ZP				
	1.8 T quattro	132		10.98	06.03	PR: 1LR,1LS,1ZP				
	1.9 TDI	66		09.96	06.01	PR: 1LR,1LS,1ZP				
	1.9 TDI	74		09.00	06.03	PR: 1LR,1LS,1ZP				
	1.9 TDI	81		03.97	06.01	PR: 1LR,1LS,1ZP				
	1.9 TDI	96		09.00	06.03	PR: 1LR,1LS,1ZP				
	1.9 TDI quattro	96		09.00	06.03	PR: 1LR,1LS,1ZP				
	1.6	75		09.96	06.03	PR: 1LE,1LN,1ZD				
	1.8	92		09.96	06.03	PR: 1LE,1LN,1ZD				
	1.8 quattro	92		08.98	06.03	PR: 1LE,1LN,1ZD				
1.8 T	110		12.96	06.03	PR: 1LE,1LN,1ZD					
1.8 T	132		12.98	06.03	PR: 1LE,1LN,1ZD					
1.8 T quattro	110		08.98	06.03	PR: 1LE,1LN,1ZD					
1.8 T quattro	132		10.98	06.03	PR: 1LE,1LN,1ZD					
1.9 TDI	66		09.96	06.01	PR: 1LE,1LN,1ZD					
1.9 TDI	74		09.00	06.03	PR: 1LE,1LN,1ZD					
1.9 TDI	81		03.97	06.01	PR: 1LE,1LN,1ZD					
1.9 TDI	96		09.00	06.03	PR: 1LE,1LN,1ZD					
1.9 TDI quattro	96		09.00	06.03	PR: 1LE,1LN,1ZD					
S3 quattro			08.98	06.03	PR: 1LT	G2125123		310 25,0 22,0 V L +C		
	1.6	75		09.96	06.03	PR: 1KK,1KV,1KE	G1020755		20961 17,1 /Acc/S	LUC
	1.8	92		09.96	06.03	PR: 1KK,1KV,1KE				
	1.8 quattro	92		08.98	06.03	PR: 1KK,1KV,1KE				
	1.8 T	110		12.96	06.03	PR: 1KK,1KV,1KE				
	1.8 T	132		12.98	06.03	PR: 1KK,1KV,1KE				
	1.8 T quattro	110		08.98	06.03	PR: 1KK,1KV,1KE				
	1.8 T quattro	132		10.98	06.03	PR: 1KK,1KV,1KE				
	1.9 TDI	66		09.96	06.01	PR: 1KK,1KV,1KE				
	1.9 TDI	74		09.00	06.03	PR: 1KK,1KV,1KE				
	1.9 TDI	81		03.97	06.01	PR: 1KK,1KV,1KE				
	1.9 TDI	96		09.00	06.03	PR: 1KK,1KV,1KE				
	1.9 TDI quattro	96		09.00	06.03	PR: 1KK,1KV,1KE				
	S3 quattro			08.98	06.03	PR: 1KF				
	1.6	75		09.96	06.03	PR: 1KK,1KV	G2109123		230 9,0 7,0 +S +C	
	1.8	92		09.96	06.03	PR: 1KK,1KV				
	1.8 T	110		12.96	06.03	PR: 1KK,1KV				
	1.8 T	132		12.98	06.03	PR: 1KK,1KV				
	1.9 TDI	66		09.96	06.01	PR: 1KK,1KV				
	1.9 TDI	74		09.00	06.03	PR: 1KK,1KV				
	1.9 TDI	81		03.97	06.01	PR: 1KK,1KV				
	1.9 TDI	96		09.00	06.03	PR: 1KK,1KV				
	1.8 quattro	92		08.98	06.03	PR: 1KE				
	1.8 T quattro	110		08.98	06.03	PR: 1KE				
	1.8 T quattro	132		10.98	06.03	PR: 1KE				
	1.9 TDI quattro	96		09.00	06.03	PR: 1KE				
	S3 quattro			08.98	06.03	PR: 1KF				

### AUDI A3 / A3 Sportback (03-13)

	1.2 TSI	77		04.10	08.13	PR: 1ZF,1ZM	G1020463		23131 19,7 +/-Wl	VW
	1.4 TFSI	92		07.07	08.13	PR: 1ZF,1ZM				
	1.6	75		05.03	08.13	PR: 1ZF,1ZM				
	1.6 FSI	85		08.03	08.13	PR: 1ZF,1ZM				
	1.6 TDI	66		05.09	08.13	PR: 1ZF,1ZM				
	1.6 TDI	77		05.09	08.13	PR: 1ZF,1ZM				
	1.8 TFSI	118		01.07	08.13	PR: 1ZF,1ZM				
	1.8 TFSI quattro	118		05.08	08.13	PR: 1ZF,1ZM				
	1.9 TDI	77		06.03	08.13	PR: 1ZF,1ZM				
	2.0 FSI	110		05.03	08.13	PR: 1ZF,1ZM				
	2.0 TDI	100		05.03	08.13	PR: 1ZF,1ZM				
	2.0 TDI	103		05.03	08.13	PR: 1ZF,1ZM				
	2.0 TDI	120		06.06	06.08	PR: 1ZF,1ZM				
	2.0 TDI	125		03.06	08.13	PR: 1ZF,1ZM				
	2.0 TDI quattro	100		05.03	08.13	PR: 1ZF,1ZM				
	2.0 TDI quattro	103		08.04	08.13	PR: 1ZF,1ZM				
	2.0 TDI quattro	125		03.06	08.13	PR: 1ZF,1ZM				
	2.0 TFSI	147		06.04	08.13	PR: 1ZF,1ZM				
	2.0 TFSI quattro	147		06.04	08.13	PR: 1ZF,1ZM				
	3.2 quattro	184		03.06	08.13	PR: 1ZF,1ZM				
	1.2 TSI	77		04.10	08.13	PR: 1ZE,1ZP,1ZD,1LJ,1ZA				
	1.4 TFSI	92		07.07	08.13	PR: 1ZE,1ZP,1ZD,1LJ,1ZA				
	1.6	75		05.03	08.13	PR: 1ZE,1ZP,1ZD,1LJ,1ZA				
	1.6 FSI	85		08.03	08.13	PR: 1ZE,1ZP,1ZD,1LJ,1ZA				
	1.6 TDI	66		05.09	08.13	PR: 1ZE,1ZP,1ZD,1LJ,1ZA				
	1.6 TDI	77		05.09	08.13	PR: 1ZE,1ZP,1ZD,1LJ,1ZA				
	1.8 TFSI	118		01.07	08.13	PR: 1ZE,1ZP,1ZD,1LJ,1ZA				
1.8 TFSI quattro	118		05.08	08.13	PR: 1ZE,1ZP,1ZD,1LJ,1ZA					
1.9 TDI	77		06.03	08.13	PR: 1ZE,1ZP,1ZD,1LJ,1ZA					
2.0 FSI	110		05.03	08.13	PR: 1ZE,1ZP,1ZD,1LJ,1ZA					
2.0 TDI	100		05.03	08.13	PR: 1ZE,1ZP,1ZD,1LJ,1ZA					
2.0 TDI	103		05.03	08.13	PR: 1ZE,1ZP,1ZD,1LJ,1ZA					
2.0 TDI	120		06.06	06.08	PR: 1ZE,1ZP,1ZD,1LJ,1ZA					
2.0 TDI	125		03.06	08.13	PR: 1ZE,1ZP,1ZD,1LJ,1ZA					
2.0 TDI quattro	100		05.03	08.13	PR: 1ZE,1ZP,1ZD,1LJ,1ZA					



**AUDI A3 / A3 Sportback (03-13)**

	2.0 TDI quattro	103	08.04	08.13	PR: 1ZE,1ZP,1ZD,1LJ,1ZA	G1020680		23587 20,6 +/Wl	ATE
	2.0 TDI quattro	125	03.06	08.13	PR: 1ZE,1ZP,1ZD,1LJ,1ZA				
	2.0 TFSI	147	06.04	08.13	PR: 1ZE,1ZP,1ZD,1LJ,1ZA				
	2.0 TFSI quattro	147	06.04	08.13	PR: 1ZE,1ZP,1ZD,1LJ,1ZA				
	3.2 quattro	184	03.06	08.13	PR: 1ZE,1ZP,1ZD,1LJ,1ZA				
	1.2 TSI	77	04.10	08.13	PR: 1LK				
	1.4 TFSI	92	07.07	08.13	PR: 1LK				
	1.6	75	05.03	08.13	PR: 1LK				
	1.6 FSI	85	08.03	08.13	PR: 1LK				
	1.6 TDI	66	05.09	08.13	PR: 1LK				
1.6 TDI	77	05.09	08.13	PR: 1LK					
1.8 TFSI	118	01.07	08.13	PR: 1LK					
1.8 TFSI quattro	118	05.08	08.13	PR: 1LK					
1.9 TDI	77	06.03	08.13	PR: 1LK					
2.0 FSI	110	05.03	08.13	PR: 1LK					
2.0 TDI	100	05.03	08.13	PR: 1LK					
2.0 TDI	103	05.03	08.13	PR: 1LK					
2.0 TDI	120	06.06	06.08	PR: 1LK					
2.0 TDI	125	03.06	08.13	PR: 1LK					
2.0 TDI quattro	100	05.03	08.13	PR: 1LK					
2.0 TDI quattro	103	08.04	08.13	PR: 1LK					
2.0 TDI quattro	125	03.06	08.13	PR: 1LK					
2.0 TFSI	147	06.04	08.13	PR: 1LK					
2.0 TFSI quattro	147	06.04	08.13	PR: 1LK					
3.2 quattro	184	03.06	08.13	PR: 1LK					
S3 quattro	188	07.08	08.13	PR: 1ZK	G1020895		23801 20,3 +/Wl	ATE	
S3 quattro	195	11.06	08.13	PR: 1ZK					
	1.2 TSI	77	04.10	08.13	PR: 1ZF,1ZM	G2122210		280 22,0 19,0 V L +S +C	
	1.4 TFSI	92	07.07	08.13	PR: 1ZF,1ZM				
	1.6	75	05.03	08.13	PR: 1ZF,1ZM				
	1.6 FSI	85	08.03	08.13	PR: 1ZF,1ZM				
	1.6 TDI	66	05.09	08.13	PR: 1ZF,1ZM				
	1.6 TDI	77	05.09	08.13	PR: 1ZF,1ZM				
	1.8 TFSI	118	01.07	08.13	PR: 1ZF,1ZM				
	1.8 TFSI quattro	118	05.08	08.13	PR: 1ZF,1ZM				
	1.9 TDI	77	06.03	08.13	PR: 1ZF,1ZM				
	2.0 FSI	110	05.03	08.13	PR: 1ZF,1ZM				
	2.0 TDI	100	05.03	08.13	PR: 1ZF,1ZM				
	2.0 TDI	103	05.03	08.13	PR: 1ZF,1ZM				
	2.0 TDI	120	06.06	06.08	PR: 1ZF,1ZM				
	2.0 TDI	125	03.06	08.13	PR: 1ZF,1ZM				
	2.0 TDI quattro	100	05.03	08.13	PR: 1ZF,1ZM				
	2.0 TDI quattro	103	08.04	08.13	PR: 1ZF,1ZM				
	2.0 TDI quattro	125	03.06	08.13	PR: 1ZF,1ZM				
	2.0 TFSI	147	06.04	08.13	PR: 1ZF,1ZM				
	2.0 TFSI quattro	147	06.04	08.13	PR: 1ZF,1ZM				
	3.2 quattro	184	03.06	08.13	PR: 1ZF,1ZM				
1.2 TSI	77	04.10	08.13	PR: 1ZE,1ZP	G2125145		288 25,0 22,0 V L +S +C		
1.4 TFSI	92	07.07	08.13	PR: 1ZE,1ZP					
1.6	75	05.03	08.13	PR: 1ZE,1ZP					
1.6 FSI	85	08.03	08.13	PR: 1ZE,1ZP					
1.6 TDI	66	05.09	08.13	PR: 1ZE,1ZP					
1.6 TDI	77	05.09	08.13	PR: 1ZE,1ZP					
1.8 TFSI	118	01.07	08.13	PR: 1ZE,1ZP					
1.8 TFSI quattro	118	05.08	08.13	PR: 1ZE,1ZP					
1.9 TDI	77	06.03	08.13	PR: 1ZE,1ZP					
2.0 FSI	110	05.03	08.13	PR: 1ZE,1ZP					
2.0 TDI	100	05.03	08.13	PR: 1ZE,1ZP					
2.0 TDI	103	05.03	08.13	PR: 1ZE,1ZP					
2.0 TDI	120	06.06	06.08	PR: 1ZE,1ZP					
2.0 TDI	125	03.06	08.13	PR: 1ZE,1ZP					
2.0 TDI quattro	100	05.03	08.13	PR: 1ZE,1ZP					
2.0 TDI quattro	103	08.04	08.13	PR: 1ZE,1ZP					
2.0 TDI quattro	125	03.06	08.13	PR: 1ZE,1ZP					
2.0 TFSI	147	06.04	08.13	PR: 1ZE,1ZP					
2.0 TFSI quattro	147	06.04	08.13	PR: 1ZE,1ZP					
3.2 quattro	184	07.03	08.13	PR: 1ZE,1ZP					
1.2 TSI	77	04.10	08.13	PR: 1ZD,1LJ,1ZA	G2125158		312 25,0 22,0 V L +S +C		
1.4 TFSI	92	07.07	08.13	PR: 1ZD,1LJ,1ZA					
1.6	75	05.03	08.13	PR: 1ZD,1LJ,1ZA					
1.6 FSI	85	08.03	08.13	PR: 1ZD,1LJ,1ZA					
1.6 TDI	66	05.09	08.13	PR: 1ZD,1LJ,1ZA					
1.6 TDI	77	05.09	08.13	PR: 1ZD,1LJ,1ZA					
1.8 TFSI	118	01.07	08.13	PR: 1ZD,1LJ,1ZA					
1.8 TFSI quattro	118	05.08	08.13	PR: 1ZD,1LJ,1ZA					
1.9 TDI	77	06.03	08.13	PR: 1ZD,1LJ,1ZA					
2.0 FSI	110	05.03	08.13	PR: 1ZD,1LJ,1ZA					
2.0 TDI	100	05.03	08.13	PR: 1ZD,1LJ,1ZA					
2.0 TDI	103	05.03	08.13	PR: 1ZD,1LJ,1ZA					
2.0 TDI	120	06.06	06.08	PR: 1ZD,1LJ,1ZA					
2.0 TDI	125	03.06	08.13	PR: 1ZD,1LJ,1ZA					
2.0 TDI quattro	100	05.03	08.13	PR: 1ZD,1LJ,1ZA					
2.0 TDI quattro	103	08.04	08.13	PR: 1ZD,1LJ,1ZA					
2.0 TDI quattro	125	03.06	08.13	PR: 1ZD,1LJ,1ZA					
2.0 TFSI	147	06.04	08.13	PR: 1ZD,1LJ,1ZA					
2.0 TFSI quattro	147	06.04	08.13	PR: 1ZD,1LJ,1ZA					
3.2 quattro	184	07.03	08.13	PR: 1ZD,1LJ,1ZA					







**AUDI A3 / A3 Sportback (03-13)**

	1.2 TSI 77 1.4 TFSI 92 1.6 75 1.6 FSI 85 1.6 TDI 66 1.6 TDI 77 1.8 TFSI 118 1.8 TFSI quattro 118 1.9 TDI 77 2.0 FSI 110 2.0 TDI 100 2.0 TDI 103 2.0 TDI 120 2.0 TDI 125 2.0 TDI quattro 100 2.0 TDI quattro 103 2.0 TDI quattro 125 2.0 TFSI 147 2.0 TFSI quattro 147 3.2 quattro 184 S3 quattro 188 S3 quattro 195			04.10 08.13 PR: 1LK 07.07 08.13 PR: 1LK 05.03 08.13 PR: 1LK 08.03 08.13 PR: 1LK 05.09 08.13 PR: 1LK 05.09 08.13 PR: 1LK 01.07 08.13 PR: 1LK 05.08 08.13 PR: 1LK 06.03 08.13 PR: 1LK 05.03 08.13 PR: 1LK 05.03 08.13 PR: 1LK 05.03 08.13 PR: 1LK 06.06 06.08 PR: 1LK 03.06 08.13 PR: 1LK 05.03 08.13 PR: 1LK 08.04 08.13 PR: 1LK 03.06 08.13 PR: 1LK 06.04 08.13 PR: 1LK 06.04 08.13 PR: 1LK 07.03 08.13 PR: 1LK 07.08 08.13 PR: 12K 11.06 08.13 PR: 12K	G2130115		345 30,0 27,0 V L +C
	1.2 TSI 77 1.4 TFSI 92 1.6 75 1.6 FSI 85 1.6 TDI 66 1.6 TDI 77 1.8 TFSI 118 1.9 TDI 77 2.0 FSI 110 2.0 TDI 100 2.0 TDI 103 2.0 TDI 120 2.0 TDI 125 2.0 TFSI 147		04.10 08.13 PR: 1KQ,1KD 07.07 08.13 PR: 1KQ,1KD 05.03 08.13 PR: 1KQ,1KD 08.03 08.13 PR: 1KQ,1KD 05.09 08.13 PR: 1KQ,1KD 05.09 08.13 PR: 1KQ,1KD 01.07 08.13 PR: 1KQ,1KD 06.03 08.13 PR: 1KQ,1KD 05.03 08.13 PR: 1KQ,1KD 05.03 08.13 PR: 1KQ,1KD 05.03 08.13 PR: 1KQ,1KD 06.06 06.08 PR: 1KQ,1KD 03.06 08.13 PR: 1KQ,1KD 06.04 08.13 PR: 1KQ,1KD	G1020492		23554 17,1 /WD/S LUC	
	1.2 TSI 77 1.4 TFSI 92 1.6 75 1.6 FSI 85 1.6 TDI 66 1.6 TDI 77 1.8 TFSI 118 1.8 TFSI quattro 118 1.9 TDI 77 2.0 FSI 110 2.0 TDI 100 2.0 TDI 103 2.0 TDI 120 2.0 TDI 125 2.0 TDI quattro 100 2.0 TDI quattro 103 2.0 TDI quattro 125 2.0 TFSI 147 2.0 TFSI quattro 147 3.2 quattro 184		04.10 08.13 PR: 1KE,1KZ 07.07 08.13 PR: 1KE,1KZ 05.03 08.13 PR: 1KE,1KZ 08.03 08.13 PR: 1KE,1KZ 05.09 08.13 PR: 1KE,1KZ 05.09 08.13 PR: 1KE,1KZ 01.07 08.13 PR: 1KE,1KZ 05.08 08.13 PR: 1KF,1KJ,1KU 06.03 08.13 PR: 1KE,1KZ 05.03 08.13 PR: 1KE,1KZ 05.03 08.13 PR: 1KE,1KZ 06.06 06.08 PR: 1KE,1KZ 03.06 08.13 PR: 1KE,1KZ 05.03 08.13 PR: 1KF,1KJ,1KU 08.04 08.13 PR: 1KF,1KJ,1KU 03.06 08.13 PR: 1KF,1KJ,1KU 06.04 08.13 PR: 1KE,1KZ 06.04 08.13 PR: 1KF,1KJ,1KU 07.03 08.13 PR: 1KF,1KJ,1KU	G1020682		23914 17,1 /WD/Acc/S LUC	
	3.2 quattro 184 RS 3 quattro 250 S3 quattro 188 S3 quattro 195		07.03 08.13 PR: 2EA 04.11 08.13 07.08 08.13 PR: 1KW 11.06 08.13 PR: 1KW	G1020682		23914 17,1 /WD/Acc/S LUC	
	1.2 TSI 77 1.4 TFSI 92 1.6 75 1.6 FSI 85 1.6 TDI 66 1.6 TDI 77 1.8 TFSI 118 1.9 TDI 77 2.0 FSI 110 2.0 TDI 100 2.0 TDI 103 2.0 TDI 120 2.0 TDI 125 2.0 TFSI 147		04.10 08.13 PR: 1KQ,1KD 07.07 08.13 PR: 1KQ,1KD 05.03 08.13 PR: 1KQ,1KD 08.03 08.13 PR: 1KQ,1KD 05.09 08.13 PR: 1KQ,1KD 05.09 08.13 PR: 1KQ,1KD 01.07 08.13 PR: 1KQ,1KD 06.03 08.13 PR: 1KQ,1KD 05.03 08.13 PR: 1KQ,1KD 05.03 08.13 PR: 1KQ,1KD 05.03 08.13 PR: 1KQ,1KD 06.06 06.08 PR: 1KQ,1KD 03.06 08.13 PR: 1KQ,1KD 06.04 08.13 PR: 1KQ,1KD	G2110277		253 10,0 8,0 +S +C	
	1.2 TSI 77 1.4 TFSI 92 1.6 75 1.6 FSI 85 1.6 TDI 66 1.6 TDI 77 1.8 TFSI 118 1.8 TFSI quattro 118 1.9 TDI 77 2.0 FSI 110 2.0 TDI 100 2.0 TDI 103 2.0 TDI 120 2.0 TDI 125		04.10 08.13 PR: 1KZ 07.07 08.13 PR: 1KZ 05.03 08.13 PR: 1KZ 08.03 08.13 PR: 1KZ 05.09 08.13 PR: 1KZ 05.09 08.13 PR: 1KZ 01.07 08.13 PR: 1KZ 05.08 08.13 PR: 1KJ 06.03 08.13 PR: 1KZ 05.03 08.13 PR: 1KZ 05.03 08.13 PR: 1KZ 05.03 08.13 PR: 1KZ 06.06 06.08 PR: 1KZ	G2112169		282 12,0 10,0 +S +C	

















**AUDI A3 / A3 Sportback (03-13)**

	2.0 TDI	125		03.06	08.13	PR: 1KZ	G2112169		282 12,0 10,0 +S +C
	2.0 TDI quattro	100		05.03	08.13	PR: 1KJ,1KU			
	2.0 TDI quattro	103		08.04	08.13	PR: 1KJ,1KU			
	2.0 TDI quattro	125		03.06	08.13	PR: 1KJ,1KU			
	2.0 TFSI	147		06.04	08.13	PR: 1KZ			
	2.0 TFSI quattro	147		06.04	08.13	PR: 1KJ,1KU			
	3.2 quattro	184		07.03	08.13	PR: 1KJ			
	1.2 TSI	77		04.10	08.13	PR: 1KE			
	1.4 TFSI	92		07.07	08.13	PR: 1KE			
	1.6	75		05.03	08.13	PR: 1KE			
1.6 FSI	85		08.03	08.13	PR: 1KE				
1.6 TDI	66		05.09	08.13	PR: 1KE				
1.6 TDI	77		05.09	08.13	PR: 1KE				
1.8 TFSI	118		01.07	08.13	PR: 1KE				
1.9 TDI	77		06.03	08.13	PR: 1KE				
2.0 FSI	110		05.03	08.13	PR: 1KE				
2.0 TDI	100		05.03	08.13	PR: 1KE				
2.0 TDI	103		05.03	08.13	PR: 1KE				
2.0 TDI	120		06.06	06.08	PR: 1KE				
2.0 TDI	125		03.06	08.13	PR: 1KE				
2.0 TDI quattro	100		05.03	08.13	PR: 1KF				
2.0 TDI quattro	103		08.04	08.13	PR: 1KF				
2.0 TDI quattro	125		03.06	08.13	PR: 1KF				
2.0 TFSI	147		06.04	08.13	PR: 1KE				
2.0 TFSI quattro	147		06.04	08.13	PR: 1KF				
1.2 TSI	77		04.10	08.13	PR: 1KS	G2110356		272 9,7 8,0 +S +C	
1.4 TFSI	92		07.07	08.13	PR: 1KS				
1.6	75		05.03	08.13	PR: 1KS				
1.6 FSI	85		08.03	08.13	PR: 1KS				
1.6 TDI	66		05.09	08.13	PR: 1KS				
1.6 TDI	77		05.09	08.13	PR: 1KS				
1.8 TFSI	118		01.07	08.13	PR: 1KS				
1.8 TFSI quattro	118		05.08	08.13	PR: 1KS				
1.9 TDI	77		06.03	08.13	PR: 1KS				
2.0 FSI	110		05.03	08.13	PR: 1KS				
2.0 TDI	100		05.03	08.13	PR: 1KS				
2.0 TDI	103		05.03	08.13	PR: 1KS				
2.0 TDI	120		06.06	06.08	PR: 1KS				
2.0 TDI	125		03.06	08.13	PR: 1KS				
2.0 TDI quattro	100		05.03	08.13	PR: 1KS				
2.0 TDI quattro	103		08.04	08.13	PR: 1KS				
2.0 TDI quattro	125		03.06	08.13	PR: 1KS				
2.0 TFSI	147		06.04	08.13	PR: 1KS				
2.0 TFSI quattro	147		06.04	08.13	PR: 1KS				
3.2 quattro	184		07.03	08.13	PR: 1KS				

**AUDI A3 Convertible (08-13)**

	1.2 TSI	77		03.10	08.13	PR: 1ZF	G1020463		23131 19,7 +/Wl	VW
	1.4 TFSI	92		01.11	08.13	PR: 1ZF				
	1.6	75		09.08	08.13	PR: 1ZF				
	1.6 TDI	77		05.09	08.13	PR: 1ZF				
	1.8 TFSI	118		04.08	08.13	PR: 1ZF				
	1.9 TDI	77		04.08	08.13	PR: 1ZF				
	2.0 TDI	100		04.08	08.13	PR: 1ZF				
	2.0 TDI	103		04.08	08.13	PR: 1ZF				
	2.0 TFSI	147		04.08	08.13	PR: 1ZF				
	1.2 TSI	77		03.10	08.13	PR: 1LJ,1ZE				
1.4 TFSI	92		01.11	08.13	PR: 1LJ,1ZE					
1.6	75		09.08	08.13	PR: 1LJ,1ZE					
1.6 TDI	77		05.09	08.13	PR: 1LJ,1ZE					
1.8 TFSI	118		04.08	08.13	PR: 1LJ,1ZE					
1.9 TDI	77		04.08	08.13	PR: 1LJ,1ZE					
2.0 TDI	100		04.08	08.13	PR: 1LJ,1ZE					
2.0 TDI	103		04.08	08.13	PR: 1LJ,1ZE					
2.0 TFSI	147		04.08	08.13	PR: 1LJ,1ZE					
	1.2 TSI	77		03.10	08.13	PR: 1ZF	G2122210		280 22,0 19,0 V L +S +C	
	1.4 TFSI	92		01.11	08.13	PR: 1ZF				
	1.6	75		09.08	08.13	PR: 1ZF				
	1.6 TDI	77		05.09	08.13	PR: 1ZF				
	1.8 TFSI	118		04.08	08.13	PR: 1ZF				
	1.9 TDI	77		04.08	08.13	PR: 1ZF				
	2.0 TDI	100		04.08	08.13	PR: 1ZF				
	2.0 TDI	103		04.08	08.13	PR: 1ZF				
	2.0 TFSI	147		04.08	08.13	PR: 1ZF				
	1.2 TSI	77		03.10	08.13	PR: 1ZE				G2125145
1.4 TFSI	92		01.11	08.13	PR: 1ZE					
1.6	75		09.08	08.13	PR: 1ZE					
1.6 TDI	77		05.09	08.13	PR: 1ZE					
1.8 TFSI	118		04.08	08.13	PR: 1ZE					
1.9 TDI	77		04.08	08.13	PR: 1ZE					
2.0 TDI	100		04.08	08.13	PR: 1ZE					
2.0 TDI	103		04.08	08.13	PR: 1ZE					
2.0 TFSI	147		04.08	08.13	PR: 1ZE					
1.2 TSI	77		03.10	08.13	PR: 1LJ	G2125158		312 25,0 22,0 V L +S +C		
1.4 TFSI	92		01.11	08.13	PR: 1LJ					
1.6	75		09.08	08.13	PR: 1LJ					
1.6 TDI	77		05.09	08.13	PR: 1LJ					
1.6 TDI	77		05.09	08.13	PR: 1LJ					



								
<b>AUDI A3 Convertible (08-13)</b>								
	1.8 TFSI 1.9 TDI 2.0 TDI 2.0 TDI 2.0 TFSI	118 77 100 103 147		04.08 04.08 04.08 04.08 04.08	08.13 08.13 08.13 08.13 08.13	PR: 1LJ PR: 1LJ PR: 1LJ PR: 1LJ PR: 1LJ	G2125158	312 25,0 22,0 V L +S +C
	1.2 TSI 1.4 TFSI 1.6 1.6 TDI 1.8 TFSI 1.9 TDI 2.0 TDI 2.0 TDI 2.0 TFSI	77 92 75 77 118 77 100 103 147		03.10 01.11 09.08 05.09 04.08 04.08 04.08 04.08 04.08	08.13 08.13 08.13 08.13 08.13 08.13 08.13 08.13 08.13	PR: 1KD PR: 1KD PR: 1KD PR: 1KD PR: 1KD PR: 1KD PR: 1KD PR: 1KD PR: 1KD	G1020492	23554 17,1 /WD/S LUC
	1.2 TSI 1.4 TFSI 1.6 1.6 TDI 1.8 TFSI 1.9 TDI 2.0 TDI 2.0 TDI 2.0 TFSI	77 92 75 77 118 77 100 103 147		03.10 01.11 09.08 05.09 04.08 04.08 04.08 04.08 04.08	08.13 08.13 08.13 08.13 08.13 08.13 08.13 08.13 08.13	PR: 1KZ PR: 1KZ PR: 1KZ PR: 1KZ PR: 1KZ PR: 1KZ PR: 1KZ PR: 1KZ PR: 1KZ	G1020682	23914 17,1 /WD/Acc/S LUC
	1.2 TSI 1.4 TFSI 1.6 1.6 TDI 1.8 TFSI 1.9 TDI 2.0 TDI 2.0 TDI 2.0 TFSI	77 92 75 77 118 77 100 103 147		03.10 01.11 09.08 05.09 04.08 04.08 04.08 04.08 04.08	08.13 08.13 08.13 08.13 08.13 08.13 08.13 08.13 08.13	PR: 1KD PR: 1KD PR: 1KD PR: 1KD PR: 1KD PR: 1KD PR: 1KD PR: 1KD PR: 1KD	G2110277	253 10,0 8,0 +S +C
	1.2 TSI 1.4 TFSI 1.6 1.6 TDI 1.8 TFSI 1.9 TDI 2.0 TDI 2.0 TDI 2.0 TFSI	77 92 75 77 118 77 100 103 147		03.10 01.11 09.08 05.09 04.08 04.08 04.08 04.08 04.08	08.13 08.13 08.13 08.13 08.13 08.13 08.13 08.13 08.13	PR: 1KZ PR: 1KZ PR: 1KZ PR: 1KZ PR: 1KZ PR: 1KZ PR: 1KZ PR: 1KZ PR: 1KZ	G2112169	282 12,0 10,0 +S +C
	1.2 TSI 1.4 TFSI 1.6 1.6 TDI 1.8 TFSI 1.9 TDI 2.0 TDI 2.0 TDI 2.0 TFSI	77 92 75 77 118 77 100 103 147		03.10 01.11 09.08 05.09 04.08 04.08 04.08 04.08 04.08	08.13 08.13 08.13 08.13 08.13 08.13 08.13 08.13 08.13	PR: 1KS PR: 1KS PR: 1KS PR: 1KS PR: 1KS PR: 1KS PR: 1KS PR: 1KS PR: 1KS	G2110356	272 9,7 8,0 +S +C
<b>AUDI A3 / A3 Sportback (12-)</b>								
	1.2 TFSI 1.4 TFSI 1.4 TFSI 1.6 TDI 1.8 TFSI 1.8 TFSI quattro 2.0 TDI 2.0 TDI 2.0 TDI 2.0 TDI 2.0 TDI quattro 2.0 TDI quattro	77 90 103 77 132 132 81 100 105 110 135 110 135		02.13 08.12 10.12 09.12 08.12 08.12 01.13 05.13 08.12 08.12 12.12 10.12 12.12		PR: 1ZA,1ZD PR: 1ZA,1ZD PR: 1ZA,1ZD PR: 1ZA,1ZD PR: 1ZA,1ZD PR: 1ZA,1ZD PR: 1ZA,1ZD PR: 1ZA,1ZD PR: 1ZA,1ZD PR: 1ZA,1ZD PR: 1ZA,1ZD PR: 1ZA,1ZD PR: 1ZA,1ZD	G2125158	312 25,0 22,0 V L +S +C
	1.2 TFSI 1.4 TFSI 1.4 TFSI 1.6 TDI 1.8 TFSI 1.8 TFSI quattro 2.0 TDI 2.0 TDI 2.0 TDI 2.0 TDI 2.0 TDI quattro 2.0 TDI quattro	77 90 103 77 132 132 81 100 105 110 135 110 135		02.13 08.12 10.12 09.12 08.12 08.12 01.13 05.13 08.12 08.12 12.12 10.12 12.12		PR: 1ZE,1ZP PR: 1ZE,1ZP PR: 1ZE,1ZP PR: 1ZE,1ZP PR: 1ZE,1ZP PR: 1ZE,1ZP PR: 1ZE,1ZP PR: 1ZE,1ZP PR: 1ZE,1ZP PR: 1ZE,1ZP PR: 1ZE,1ZP PR: 1ZE,1ZP PR: 1ZE,1ZP	G2125145	288 25,0 22,0 V L +S +C
	1.2 TFSI 1.4 TFSI 1.4 TFSI 1.6 TDI 1.8 TFSI 1.8 TFSI quattro 2.0 TDI 2.0 TDI	77 90 103 77 132 132 81 100		02.13 08.12 10.12 09.12 08.12 08.12 01.13 05.13		PR: 1KE PR: 1KE PR: 1KE PR: 1KE PR: 1KE PR: 1KE PR: 1KE PR: 1KE	G2110356	electric parking brake <sup>1)</sup> 272 9,7 8,0 +S +C

<sup>1)</sup> fr.di stazionamento elettrico / frein à main électrique / freno de mano eléctrico / elektrische Feststellbremse



### AUDI A3 / A3 Sportback (12-)

	2.0 TDI	105		08.12	PR: 1KE	G2110356	electric parking brake <sup>1)</sup>	272 9,7 8,0 +S +C
	2.0 TDI	110		08.12	PR: 1KE			
	2.0 TDI	135		12.12	PR: 1KE			
	2.0 TDI quattro	110		10.12	PR: 1KE			
	2.0 TDI quattro	135		12.12	PR: 1KE			
	S3	206		02.13	PR: 1KE			
	S3	221		10.12	PR: 1KE			

### AUDI A4 (B5) (95-01)

	1.6		8D-V-160000	11.94		G1020196		20669 19,0 /S	LUC
	1.9 TDI	55	8D-V-160000	03.96		G1020421		21945 19,6 /S	LUC
	1.9 TDI	66	8D-V-160000	01.95					
	1.8	85	8D-V-054061	07.95	+ (M) / + GUS States <sup>2)</sup>	G1020313		23018 20,3 +/Wl	ATE
	1.8	92	8D-V-054061	11.94		G1020312		21624 20,3 +	ATE
	1.8	95	8D-V-054061	01.95					
	1.8 T			05.95	04.01				
	1.9 TDI	81		02.96	04.01				
	1.9 TDI	85		03.00	04.01				
	2.4			07.95	07.97 + (T)				
	2.4	121		08.97	04.01				
	2.5 TDI			08.97	04.01				
	2.6			11.94	04.01				
	2.8	128		11.94	07.97				
	2.8	142		03.96	04.01				
	1.8 quattro	85	8D-V-054061	11.94	+ GUS States <sup>3)</sup>	G1020312		21624 20,3 +	ATE
	1.8 quattro	92	8D-V-054061	02.95					
	1.8 T quattro	110		02.95	01.99				
	1.8 T quattro	132		08.97	01.99				
	1.9 TDI quattro	81		07.96	01.99				
	2.4 quattro			08.97	01.99				
	2.5 TDI quattro			11.97	01.99				
	2.6 quattro			11.94	01.99				
	2.8 quattro	128		11.94	07.96				
	2.8 quattro	142		06.96	01.99				
	1.8 T quattro	110		02.99	04.01	G1020313		23018 20,3 +/Wl	ATE
	1.8 T quattro	132		02.99	04.01				
	1.9 TDI quattro	81		02.99	04.01				
	1.9 TDI quattro	85		03.00	04.01				
	2.4 quattro			02.99	04.01				
	2.5 TDI quattro			02.99	04.01				
	2.6 quattro			02.99	04.01				
	2.8 quattro	142		02.99	04.01				
	1.6		8D-V-160001	04.01		G1020511		21945 19,6 +/Wl/S	LUC
	1.8	85	8D-V-054062	04.01	+ (M) / + GUS States <sup>2)</sup>	G1020421		21945 19,6 /S	LUC
	1.8	92	8D-V-054062	04.01					
	1.8	95	8D-V-054062	04.01					
	1.8 quattro	85	8D-V-054062	04.01	+ GUS States <sup>3)</sup>				
	1.8 quattro	92	8D-V-054062	04.01					
	1.9 TDI	55	8D-V-160001	04.01					
	1.9 TDI	66	8D-V-160001	04.01					
	RS 4			06.00	04.01	G1020683		21484 20,5 +/WD	ATE
	1.9 TDI	55	8D-V-160000	03.96		G2113181		280 13,0 11,0 L +C	
	1.9 TDI	66	8D-V-160000	01.95					
	1.6		8D-V-054061	11.94		G2115105		288 15,0 13,0 L +C	
	1.8	85	8D-V-054061	07.95	+ (M) / + GUS States <sup>2)</sup>				
	1.8	92	8D-V-054061	11.94					
	1.8	95	8D-V-054061	01.95					
	1.8 quattro	85	8D-V-054061	07.95	+ GUS States <sup>3)</sup>				
	1.8 quattro	92	8D-V-054061	11.94					
	1.6		8D-V-054062	04.01		G2122152		280 22,0 20,0 V L +C	
	1.8	85	8D-V-054062	04.01	+ (M) / + GUS States <sup>2)</sup>				
	1.8	92	8D-V-054062	04.01					
	1.8	95	8D-V-054062	04.01					
	1.8 quattro	85	8D-V-054062	04.01	+ GUS States <sup>3)</sup>				
	1.8 quattro	92	8D-V-054062	04.01					
	1.9 TDI	55	8D-V-160001	04.01					
	1.9 TDI	66	8D-V-160001	04.01					
	1.8 T			05.95	04.01	G2125105		288 25,0 23,0 V L +C	
	1.8 T quattro	110		02.95	04.01				
	1.8 T quattro	132		08.97	04.01				
	1.9 TDI	81		02.96	04.01				
	1.9 TDI	85		03.00	04.01				
	1.9 TDI quattro	81		07.96	04.01				
	1.9 TDI quattro	85		03.00	04.01				
	2.4			07.95	07.97 + (T)				
	2.4	121		08.97	04.01				
	2.4 quattro			08.97	04.01				
	2.5 TDI			08.97	04.01				
	2.5 TDI quattro			11.97	04.01				
	2.6			11.94	04.01				
	2.6 quattro			11.94	04.01				
	2.8	128		11.94	07.97				
	2.8	142		03.96	04.01				
	2.8 quattro	128		11.94	07.96				
	2.8 quattro	142		09.96	04.01				
	S4 quattro			10.97	04.01	G2130113		320 30,0 28,0 V L +C	

<sup>1)</sup> fr. di stazionamento elettrico / frein à main électrique / freno de mano eléctrico / elektrische Feststellbremse  
<sup>2)</sup> + (M) / + Stati del GUS / + (M) / + Etats de la CEI / + (M) / + estados del GUS / + (M) / + GUS-Staaten  
<sup>3)</sup> + Stati del GUS / + Etats de la CEI / + estados del GUS / + GUS-Staaten





**AUDI A4 (B5) (95-01)**

	1.6		8D-V-160000	11.94		G1020246		21144 15,8 /S	LUC
	1.8		8D-V-160000	11.94					
	1.8 quattro	85		11.94	04.01				
	1.8 quattro	92		11.94	04.01				
	1.8 T		8D-V-160000	05.95					
	1.8 T quattro	110		02.95	04.01				
	1.8 T quattro	132		08.97	04.01				
	1.9 TDI	55	8D-V-160000	03.96					
	1.9 TDI	66	8D-V-160000	01.95					
	1.9 TDI	81	8D-V-160000	02.96					
	1.9 TDI	85	8D-V-160000	03.00					
	1.9 TDI quattro	81		07.96	04.01				
	1.9 TDI quattro	85		03.00	04.01				
	2.4		8D-V-160000	07.95	+ (T)				
	2.4 quattro			08.97	04.01				
	2.5 TDI		8D-V-160000	08.97					
	2.5 TDI quattro			11.97	04.01				
	2.6		8D-V-160000	11.94					
	2.6 quattro			11.94	04.01				
	2.8	128	8D-V-160000	11.94					
2.8	142	8D-V-160000	03.96						
2.8 quattro	128		11.94	07.96					
2.8 quattro	142		09.96	04.01					
<b>AUDI A4 (B5) (95-01)</b>									
	1.6		8D-V-160001		04.01	G1020492		23554 17,1 /WD/S	LUC
	1.8		8D-V-160001		04.01				
	1.8 T		8D-V-160001		04.01				
	1.9 TDI	55	8D-V-160001		04.01				
	1.9 TDI	66	8D-V-160001		04.01				
	1.9 TDI	81	8D-V-160001		04.01				
	1.9 TDI	85		03.00	04.01				
	2.4		8D-V-160001		07.97 + (T)				
	2.4	121		08.97	04.01				
	2.5 TDI			08.97	04.01				
	2.6		8D-V-160001		04.01				
	2.8	128	8D-V-160001		07.97				
	2.8	142	8D-V-160001		04.01				
	S4 quattro			10.97	04.01				
<b>AUDI A4 (B5) (95-01)</b>									
	1.6			11.94	04.01	G2110210		245 10,0 8,0 +C	
	1.8			11.94	04.01				
	1.8 T			05.95	04.01				
	1.9 TDI	55		03.96	04.01				
	1.9 TDI	66		01.95	04.01				
	1.9 TDI	81		02.96	04.01				
	1.9 TDI	85		03.00	04.01				
	2.4			07.95	07.97 + (T)				
	2.4	121		08.97	04.01				
	2.5 TDI			08.97	04.01				
	2.6			11.94	04.01				
	2.8	128		11.94	07.97				
	2.8	142		03.96	04.01				

**AUDI A4 (B6/B7) (01-08)**

	1.6	75		12.00	11.08	PR: 1LZ	G1020511		21945 19,6 +/M/S	LUC
	1.8 T	110		12.00	11.08	PR: 1LZ				
	1.8 T	120		07.02	11.08	PR: 1LZ				
	1.8 T	125		07.01	11.08	PR: 1LZ				
	1.8 T	140		11.02	11.08	PR: 1LZ				
	1.8 T quattro	110		12.00	11.08	PR: 1LZ				
	1.8 T quattro	120		07.02	11.08	PR: 1LZ				
	1.8 T quattro	125		07.01	11.08	PR: 1LZ				
	1.8 T quattro	140		11.02	11.08	PR: 1LZ				
	1.9 TDI	74		04.01	11.08	PR: 1LZ				
	1.9 TDI	85		06.04	11.08	PR: 1LZ				
	1.9 TDI	96		12.00	11.08	PR: 1LZ				
	1.9 TDI quattro			12.00	11.08	PR: 1LZ				
	2.0	96		12.00	11.08	PR: 1LZ				
	2.0 FSI	110		07.02	11.08	PR: 1LZ				
	2.0 TDI	100		11.04	11.08	PR: 1LZ				
	2.0 TDI	103		11.04	11.08	PR: 1LZ				
	2.0 TDI	125		06.06	11.08	PR: 1LZ				
	2.0 TDI quattro	103		01.06	11.08	PR: 1LZ				
	2.0 TDI quattro	125		06.06	11.08	PR: 1LZ				
	2.0 TFSI	147		11.04	11.08	PR: 1LZ				
	2.0 TFSI	162		06.05	11.08	PR: 1LZ				
	2.0 TFSI quattro	147		11.04	11.08	PR: 1LZ				
	2.0 TFSI quattro	162		06.05	11.08	PR: 1LZ				
	2.4			09.01	11.08	PR: 1LZ				
	2.5 TDI			12.00	11.08	PR: 1LZ				
	2.5 TDI quattro			12.00	11.08	PR: 1LZ				
	2.7 TDI	120		11.05	11.08	PR: 1LZ				
	2.7 TDI	132		01.06	11.08	PR: 1LZ				
	3.0			12.00	11.08	PR: 1LZ				
	3.0 quattro			12.00	11.08	PR: 1LZ				
	3.0 TDI quattro	150		11.04	11.08	PR: 1LZ				
	3.0 TDI quattro	171		01.06	11.08	PR: 1LZ				
	3.2 FSI	188		01.05	11.08	PR: 1LZ				
	3.2 FSI quattro	188		01.05	11.08	PR: 1LZ				



**AUDI A4 (B6/B7) (01-08)**

	1.6	75	12.00	11.08	PR: 1LB,1LE,1LF,1LT	<b>G1020313</b>		23018 20,3 +/Wl	<b>ATE</b>					
	1.8 T	110	12.00	11.08	PR: 1LB,1LE,1LF,1LT									
	1.8 T	120	07.02	11.08	PR: 1LB,1LE,1LF,1LT									
	1.8 T	125	07.01	11.08	PR: 1LB,1LE,1LF,1LT									
	1.8 T	140	11.02	11.08	PR: 1LB,1LE,1LF,1LT									
	1.8 T quattro	110	12.00	11.08	PR: 1LB,1LE,1LF,1LT									
	1.8 T quattro	120	07.02	11.08	PR: 1LB,1LE,1LF,1LT									
	1.8 T quattro	125	07.01	11.08	PR: 1LB,1LE,1LF,1LT									
	1.8 T quattro	140	11.02	11.08	PR: 1LB,1LE,1LF,1LT									
	1.9 TDI	74	04.01	11.08	PR: 1LB,1LE,1LF,1LT									
	1.9 TDI	85	06.04	11.08	PR: 1LB,1LE,1LF,1LT									
	1.9 TDI	96	12.00	11.08	PR: 1LB,1LE,1LF,1LT									
	1.9 TDI quattro		12.00	11.08	PR: 1LB,1LE,1LF,1LT									
	2.0	96	12.00	11.08	PR: 1LB,1LE,1LF,1LT									
	2.0 FSI	110	07.02	11.08	PR: 1LB,1LE,1LF,1LT									
	2.0 TDI	100	11.04	11.08	PR: 1LB,1LE,1LF,1LT									
	2.0 TDI	103	11.04	11.08	PR: 1LB,1LE,1LF,1LT									
	2.0 TDI	125	06.06	11.08	PR: 1LB,1LE,1LF,1LT									
	2.0 TDI quattro	103	01.06	11.08	PR: 1LB,1LE,1LF,1LT									
	2.0 TDI quattro	125	06.06	11.08	PR: 1LB,1LE,1LF,1LT									
	2.0 TFSI	147	11.04	11.08	PR: 1LB,1LE,1LF,1LT									
	2.0 TFSI	162	06.05	11.08	PR: 1LB,1LE,1LF,1LT									
	2.0 TFSI quattro	147	11.04	11.08	PR: 1LB,1LE,1LF,1LT									
	2.0 TFSI quattro	162	06.05	11.08	PR: 1LB,1LE,1LF,1LT									
	2.4		09.01	11.08	PR: 1LB,1LE,1LF,1LT									
	2.5 TDI		12.00	11.08	PR: 1LB,1LE,1LF,1LT									
	2.5 TDI quattro		12.00	11.08	PR: 1LB,1LE,1LF,1LT									
	2.7 TDI	120	11.05	11.08	PR: 1LB,1LE,1LF,1LT									
	2.7 TDI	132	01.06	11.08	PR: 1LB,1LE,1LF,1LT									
	3.0		12.00	11.08	PR: 1LB,1LE,1LF,1LT									
	3.0 quattro		12.00	11.08	PR: 1LB,1LE,1LF,1LT									
	3.0 TDI quattro	150	11.04	11.08	PR: 1LB,1LE,1LF,1LT									
	3.0 TDI quattro	171	01.06	11.08	PR: 1LB,1LE,1LF,1LT									
	3.2 FSI	188	01.05	11.08	PR: 1LB,1LE,1LF,1LT									
	3.2 FSI quattro	188	01.05	11.08	PR: 1LB,1LE,1LF,1LT									
		1.6	75	12.00	11.08					PR: 1LA,1LC	<b>G1020754</b>		23763 20,3 +/Wl	<b>ATE</b>
		1.8 T	110	12.00	11.08					PR: 1LA,1LC				
		1.8 T	120	07.02	11.08					PR: 1LA,1LC				
		1.8 T	125	07.01	11.08					PR: 1LA,1LC				
1.8 T		140	11.02	11.08	PR: 1LA,1LC									
1.8 T quattro		110	12.00	11.08	PR: 1LA,1LC									
1.8 T quattro		120	07.02	11.08	PR: 1LA,1LC									
1.8 T quattro		125	07.01	11.08	PR: 1LA,1LC									
1.8 T quattro		140	11.02	11.08	PR: 1LA,1LC									
1.9 TDI		74	04.01	11.08	PR: 1LA,1LC									
1.9 TDI		85	06.04	11.08	PR: 1LA,1LC									
1.9 TDI		96	12.00	11.08	PR: 1LA,1LC									
1.9 TDI quattro			12.00	11.08	PR: 1LA,1LC									
2.0		96	12.00	11.08	PR: 1LA,1LC									
2.0 FSI		110	07.02	11.08	PR: 1LA,1LC									
2.0 TDI		100	11.04	11.08	PR: 1LA,1LC									
2.0 TDI		103	11.04	11.08	PR: 1LA,1LC									
2.0 TDI		125	06.06	11.08	PR: 1LA,1LC									
2.0 TDI quattro		103	01.06	11.08	PR: 1LA,1LC									
2.0 TDI quattro		125	06.06	11.08	PR: 1LA,1LC									
2.0 TFSI		147	11.04	11.08	PR: 1LA,1LC									
2.0 TFSI		162	06.05	11.08	PR: 1LA,1LC									
2.0 TFSI quattro		147	11.04	11.08	PR: 1LA,1LC									
2.0 TFSI quattro		162	06.05	11.08	PR: 1LA,1LC									
2.4			09.01	11.08	PR: 1LA,1LC									
2.5 TDI			12.00	11.08	PR: 1LA,1LC									
2.5 TDI quattro			12.00	11.08	PR: 1LA,1LC									
2.7 TDI		120	11.05	11.08	PR: 1LA,1LC									
2.7 TDI	132	01.06	11.08	PR: 1LA,1LC										
3.0		12.00	11.08	PR: 1LA,1LC										
3.0 quattro		12.00	11.08	PR: 1LA,1LC										
3.0 TDI quattro	150	11.04	11.08	PR: 1LA,1LC										
3.0 TDI quattro	171	01.06	11.08	PR: 1LA,1LC										
3.2 FSI	188	01.05	11.08	PR: 1LA,1LC										
3.2 FSI quattro	188	01.05	11.08	PR: 1LA,1LC										
S4 4.2	253	03.03	11.08	PR: 1LJ	<b>G1020754</b>		23763 20,3 +/Wl	<b>ATE</b>						
	1.6	75	12.00	11.08	PR: 1LZ	<b>G2122152</b>		280 22,0 20,0 V L +C						
	1.8 T	110	12.00	11.08	PR: 1LZ									
	1.8 T	120	07.02	11.08	PR: 1LZ									
	1.8 T	125	07.01	11.08	PR: 1LZ									
	1.8 T	140	11.02	11.08	PR: 1LZ									
	1.8 T quattro	110	12.00	11.08	PR: 1LZ									
	1.8 T quattro	120	07.02	11.08	PR: 1LZ									
	1.8 T quattro	125	07.01	11.08	PR: 1LZ									
	1.8 T quattro	140	11.02	11.08	PR: 1LZ									
	1.9 TDI	74	04.01	11.08	PR: 1LZ									
	1.9 TDI	85	06.04	11.08	PR: 1LZ									
	1.9 TDI	96	12.00	11.08	PR: 1LZ									
	1.9 TDI quattro		12.00	11.08	PR: 1LZ									
2.0	96	12.00	11.08	PR: 1LZ										
2.0 FSI	110	07.02	11.08	PR: 1LZ										
2.0 TDI	100	11.04	11.08	PR: 1LZ										





**AUDI A4 (B6/B7) (01-08)**

	2.0 TDI	103		11.04	11.08	PR: 1LZ	<b>G2122152</b>		280 22,0 20,0 V L +C
	2.0 TDI	125		06.06	11.08	PR: 1LZ			
	2.0 TDI quattro	103		01.06	11.08	PR: 1LZ			
	2.0 TDI quattro	125		06.06	11.08	PR: 1LZ			
	2.0 TFSI	147		11.04	11.08	PR: 1LZ			
	2.0 TFSI	162		06.05	11.08	PR: 1LZ			
	2.0 TFSI quattro	147		11.04	11.08	PR: 1LZ			
	2.0 TFSI quattro	162		06.05	11.08	PR: 1LZ			
	2.4			09.01	11.08	PR: 1LZ			
	2.5 TDI			12.00	11.08	PR: 1LZ			
	2.5 TDI quattro			12.00	11.08	PR: 1LZ			
	2.7 TDI	120		11.05	11.08	PR: 1LZ			
	2.7 TDI	132		01.06	11.08	PR: 1LZ			
	3.0			12.00	11.08	PR: 1LZ			
	3.0 quattro			12.00	11.08	PR: 1LZ			
	3.0 TDI quattro	150		11.04	11.08	PR: 1LZ			
	3.0 TDI quattro	171		01.06	11.08	PR: 1LZ			
3.2 FSI	188		01.05	11.08	PR: 1LZ				
3.2 FSI quattro	188		01.05	11.08	PR: 1LZ				
	1.6	75		12.00	11.08	PR: 1LB,1LE	<b>G2125105</b>		288 25,0 23,0 V L +C
	1.8 T	110		12.00	11.08	PR: 1LB,1LE			
	1.8 T	120		07.02	11.08	PR: 1LB,1LE			
	1.8 T	125		07.01	11.08	PR: 1LB,1LE			
	1.8 T	140		11.02	11.08	PR: 1LB,1LE			
	1.8 T quattro	110		12.00	11.08	PR: 1LB,1LE			
	1.8 T quattro	120		07.02	11.08	PR: 1LB,1LE			
	1.8 T quattro	125		07.01	11.08	PR: 1LB,1LE			
	1.8 T quattro	140		11.02	11.08	PR: 1LB,1LE			
	1.9 TDI	74		04.01	11.08	PR: 1LB,1LE			
	1.9 TDI	85		06.04	11.08	PR: 1LB,1LE			
	1.9 TDI	96		12.00	11.08	PR: 1LB,1LE			
	1.9 TDI quattro			12.00	11.08	PR: 1LB,1LE			
	2.0	96		12.00	11.08	PR: 1LB,1LE			
	2.0 FSI	110		07.02	11.08	PR: 1LB,1LE			
	2.0 TDI	100		11.04	11.08	PR: 1LB,1LE			
	2.0 TDI	103		11.04	11.08	PR: 1LB,1LE			
	2.0 TDI	125		06.06	11.08	PR: 1LB,1LE			
	2.0 TDI quattro	103		01.06	11.08	PR: 1LB,1LE			
	2.0 TDI quattro	125		06.06	11.08	PR: 1LB,1LE			
	2.0 TFSI	147		11.04	11.08	PR: 1LB,1LE			
	2.0 TFSI quattro	147		11.04	11.08	PR: 1LB,1LE			
	2.4			09.01	11.08	PR: 1LB,1LE			
	2.5 TDI			12.00	11.08	PR: 1LB,1LE			
	2.5 TDI quattro			12.00	11.08	PR: 1LB,1LE			
	2.7 TDI	120		11.05	11.08	PR: 1LB,1LE			
	2.7 TDI	132		01.06	11.08	PR: 1LB,1LE			
	2.0 TFSI	162		06.05	11.08	PR: 1LB,1LE	<b>G2125105</b>		288 25,0 23,0 V L +C
	2.0 TFSI quattro	162		06.05	11.08	PR: 1LB,1LE			
	3.0			12.00	11.08	PR: 1LB,1LE			
	3.0 quattro			12.00	11.08	PR: 1LB,1LE			
	3.0 TDI quattro	150		11.04	11.08	PR: 1LB,1LE			
	3.0 TDI quattro	171		01.06	11.08	PR: 1LB,1LE			
	3.2 FSI	188		01.05	11.08	PR: 1LB,1LE			
3.2 FSI quattro	188		01.05	11.08	PR: 1LB,1LE				
	1.6	75		12.00	11.08	PR: 1LF,1LT	<b>G2125137</b>		312 25,0 23,0 V L +C
	1.8 T	110		12.00	11.08	PR: 1LF,1LT			
	1.8 T	120		07.02	11.08	PR: 1LF,1LT			
	1.8 T	125		07.01	11.08	PR: 1LF,1LT			
	1.8 T quattro	110		12.00	11.08	PR: 1LF,1LT			
	1.8 T quattro	120		07.02	11.08	PR: 1LF,1LT			
	1.8 T quattro	125		07.01	11.08	PR: 1LF,1LT			
	1.9 TDI	74		04.01	11.08	PR: 1LF,1LT			
	1.9 TDI	85		06.04	11.08	PR: 1LF,1LT			
	1.9 TDI	96		12.00	11.08	PR: 1LF,1LT			
	1.9 TDI quattro			12.00	11.08	PR: 1LF,1LT			
	2.0	96		12.00	11.08	PR: 1LF,1LT			
	2.0 FSI	110		07.02	11.08	PR: 1LF,1LT			
	2.0 TDI	100		11.04	11.08	PR: 1LF,1LT			
	2.0 TDI	103		11.04	11.08	PR: 1LF,1LT			
	2.0 TDI	125		06.06	11.08	PR: 1LF,1LT			
	2.0 TDI quattro	103		01.06	11.08	PR: 1LF,1LT			
2.0 TDI quattro	125		06.06	11.08	PR: 1LF,1LT				
2.4			09.01	11.08	PR: 1LF,1LT				
2.5 TDI			12.00	11.08	PR: 1LF,1LT				
2.5 TDI quattro			12.00	11.08	PR: 1LF,1LT				
2.7 TDI	120		11.05	11.08	PR: 1LF,1LT				
	1.8 T	140		11.02	11.08	PR: 1LF,1LT	<b>G2125137</b>		312 25,0 23,0 V L +C
	1.8 T quattro	140		11.02	11.08	PR: 1LF,1LT			
	2.0 TFSI	147		11.04	11.08	PR: 1LF,1LT			
	2.0 TFSI	162		06.05	11.08	PR: 1LF,1LT			
	2.0 TFSI quattro	147		11.04	11.08	PR: 1LF,1LT			
	2.0 TFSI quattro	162		06.05	11.08	PR: 1LF,1LT			
	2.7 TDI	132		01.06	11.08	PR: 1LF,1LT			
	3.0			12.00	11.08	PR: 1LF,1LT			
	3.0 quattro			12.00	11.08	PR: 1LF,1LT			
3.0 TDI quattro	150		11.04	11.08	PR: 1LF,1LT				
3.0 TDI quattro	171		01.06	11.08	PR: 1LF,1LT				



**AUDI A4 (B6/B7) (01-08)**

	3.2 FSI 188		<b>01.05</b>	<b>11.08</b>	PR: 1LF,1LT	<b>G2125137</b>		312 25,0 23,0 V L +C
	3.2 FSI quattro 188		<b>01.05</b>	<b>11.08</b>	PR: 1LF,1LT			
	1.6 75		<b>12.00</b>	<b>11.08</b>	PR: 1LA	<b>G2130113</b>		320 30,0 28,0 V L +C
	1.8 T 110		<b>12.00</b>	<b>11.08</b>	PR: 1LA			
	1.8 T 120		<b>07.02</b>	<b>11.08</b>	PR: 1LA			
	1.8 T 125		<b>07.01</b>	<b>11.08</b>	PR: 1LA			
	1.8 T 140		<b>11.02</b>	<b>11.08</b>	PR: 1LA			
	1.8 T quattro 110		<b>12.00</b>	<b>11.08</b>	PR: 1LA			
	1.8 T quattro 120		<b>07.02</b>	<b>11.08</b>	PR: 1LA			
	1.8 T quattro 125		<b>07.01</b>	<b>11.08</b>	PR: 1LA			
	1.8 T quattro 140		<b>11.02</b>	<b>11.08</b>	PR: 1LA			
	1.9 TDI 74		<b>04.01</b>	<b>11.08</b>	PR: 1LA			
	1.9 TDI 85		<b>06.04</b>	<b>11.08</b>	PR: 1LA			
	1.9 TDI 96		<b>12.00</b>	<b>11.08</b>	PR: 1LA			
	1.9 TDI quattro 120		<b>12.00</b>	<b>11.08</b>	PR: 1LA			
	2.0 96		<b>12.00</b>	<b>11.08</b>	PR: 1LA			
	2.0 FSI 110		<b>07.02</b>	<b>11.08</b>	PR: 1LA			
	2.0 TDI 100		<b>11.04</b>	<b>11.08</b>	PR: 1LA			
	2.0 TDI 103		<b>11.04</b>	<b>11.08</b>	PR: 1LA			
	2.0 TDI 125		<b>06.06</b>	<b>11.08</b>	PR: 1LA			
	2.0 TDI quattro 103		<b>01.06</b>	<b>11.08</b>	PR: 1LA			
	2.0 TDI quattro 125		<b>06.06</b>	<b>11.08</b>	PR: 1LA			
	2.0 TFSI 147		<b>11.04</b>	<b>11.08</b>	PR: 1LA			
	2.0 TFSI 162		<b>06.05</b>	<b>11.08</b>	PR: 1LA			
	2.0 TFSI quattro 147		<b>11.04</b>	<b>11.08</b>	PR: 1LA			
	2.0 TFSI quattro 162		<b>06.05</b>	<b>11.08</b>	PR: 1LA			
	2.4 147		<b>09.01</b>	<b>11.08</b>	PR: 1LA			
	2.5 TDI 162		<b>12.00</b>	<b>11.08</b>	PR: 1LA			
	2.5 TDI quattro 120		<b>12.00</b>	<b>11.08</b>	PR: 1LA			
	2.7 TDI 132		<b>11.05</b>	<b>11.08</b>	PR: 1LA			
	2.7 TDI 132		<b>01.06</b>	<b>11.08</b>	PR: 1LA			
	3.0 150		<b>12.00</b>	<b>11.08</b>	PR: 1LA			
	3.0 quattro 171		<b>12.00</b>	<b>11.08</b>	PR: 1LA			
	3.0 TDI quattro 188		<b>11.04</b>	<b>11.08</b>	PR: 1LA			
	3.0 TDI quattro 188		<b>01.06</b>	<b>11.08</b>	PR: 1LA			
	3.2 FSI 188		<b>01.05</b>	<b>11.08</b>	PR: 1LA			
	3.2 FSI quattro 188		<b>01.05</b>	<b>11.08</b>	PR: 1LA			
	1.6 75	8E-4-180000	<b>12.00</b>		PR: 1KD	<b>G1020492</b>		23554 17,1 /WD/S LUC
	1.8 T 110	8E-4-180000	<b>12.00</b>		PR: 1KD			
	1.8 T 120	8E-4-180000	<b>07.02</b>		PR: 1KD			
	1.8 T 125	8E-4-180000	<b>07.01</b>		PR: 1KD			
	1.8 T 140	8E-4-180000	<b>11.02</b>		PR: 1KD			
	1.8 T quattro 110	8E-4-180000	<b>12.00</b>		PR: 1KD			
	1.8 T quattro 120	8E-4-180000	<b>07.02</b>		PR: 1KD			
	1.8 T quattro 125	8E-4-180000	<b>07.01</b>		PR: 1KD			
	1.8 T quattro 140	8E-4-180000	<b>11.02</b>		PR: 1KD			
	1.9 TDI 74	8E-4-180000	<b>04.01</b>		PR: 1KD			
	1.9 TDI 96	8E-4-180000	<b>12.00</b>		PR: 1KD			
	1.9 TDI quattro 96	8E-4-180000	<b>12.00</b>		PR: 1KD			
	2.0 110	8E-4-180000	<b>12.00</b>		PR: 1KD			
	2.0 FSI 110	8E-4-180000	<b>07.02</b>		PR: 1KD			
	2.4 147	8E-4-180000	<b>09.01</b>		PR: 1KD			
	2.5 TDI 162	8E-4-180000	<b>12.00</b>		PR: 1KD			
	2.5 TDI quattro 120	8E-4-180000	<b>12.00</b>		PR: 1KD			
	1.6 75	8E-4-180000	<b>12.00</b>		PR: 1KP	<b>G1020559</b>		23554 16,3 /WD/S LUC
	1.8 T 110	8E-4-180000	<b>12.00</b>		PR: 1KP			
	1.8 T 120	8E-4-180000	<b>07.02</b>		PR: 1KP			
	1.8 T 125	8E-4-180000	<b>07.01</b>		PR: 1KP			
	1.8 T 140	8E-4-180000	<b>11.02</b>		PR: 1KP			
	1.8 T quattro 110	8E-4-180000	<b>12.00</b>		PR: 1KP			
	1.8 T quattro 120	8E-4-180000	<b>07.02</b>		PR: 1KP			
	1.8 T quattro 125	8E-4-180000	<b>07.01</b>		PR: 1KP			
	1.8 T quattro 140	8E-4-180000	<b>11.02</b>		PR: 1KP			
	1.9 TDI 74	8E-4-180000	<b>04.01</b>		PR: 1KP			
	1.9 TDI 96	8E-4-180000	<b>12.00</b>		PR: 1KP			
	1.9 TDI quattro 96	8E-4-180000	<b>12.00</b>		PR: 1KP			
	2.0 110	8E-4-180000	<b>12.00</b>		PR: 1KP			
	2.0 FSI 110	8E-4-180000	<b>07.02</b>		PR: 1KP			
	2.4 147	8E-4-180000	<b>09.01</b>		PR: 1KP			
	2.5 TDI 162	8E-4-180000	<b>12.00</b>		PR: 1KP			
	2.5 TDI quattro 120	8E-4-180000	<b>12.00</b>		PR: 1KP			
	1.6 75	8E-4-180001		<b>11.08</b>	PR: 1KD,1KP	<b>G1020676</b>		20961 15,8 /S LUC
	1.8 T 110	8E-4-180001		<b>11.08</b>	PR: 1KD,1KP			
	1.8 T 120	8E-4-180001		<b>11.08</b>	PR: 1KD,1KP			
	1.8 T 125	8E-4-180001		<b>11.08</b>	PR: 1KD,1KP			
	1.8 T 140	8E-4-180001		<b>11.08</b>	PR: 1KD,1KP			
	1.8 T quattro 110	8E-4-180001		<b>11.08</b>	PR: 1KD,1KP			
	1.8 T quattro 120	8E-4-180001		<b>11.08</b>	PR: 1KD,1KP			
	1.8 T quattro 125	8E-4-180001		<b>11.08</b>	PR: 1KD,1KP			
	1.8 T quattro 140	8E-4-180001		<b>11.08</b>	PR: 1KD,1KP			
	1.9 TDI 74	8E-4-180001		<b>11.08</b>	PR: 1KD,1KP			
	1.9 TDI 85		<b>06.04</b>	<b>11.08</b>	PR: 1KD,1KP			
	1.9 TDI 96	8E-4-180001		<b>11.08</b>	PR: 1KD,1KP			
	1.9 TDI quattro 96	8E-4-180001		<b>11.08</b>	PR: 1KD,1KP			
	2.0 110	8E-4-180001		<b>11.08</b>	PR: 1KD,1KP			
	2.0 FSI 110	8E-4-180001		<b>11.08</b>	PR: 1KD,1KP			
	2.0 TDI 103		<b>11.04</b>	<b>11.08</b>	PR: 1KD,1KP			







**AUDI A4 (B6/B7) (01-08)**

	2.0 TDI	125		06.06	11.08	PR: 1KD,1KP	G1020676	20961 15,8 /S	LUC			
	2.0 TDI quattro	103		01.06	11.08	PR: 1KD,1KP						
	2.0 TDI quattro	125		06.06	11.08	PR: 1KD,1KP						
	2.0 TFSI	147		11.04	11.08	PR: 1KD,1KP						
	2.0 TFSI	162		06.05	11.08	PR: 1KD,1KP						
	2.0 TFSI quattro	147		11.04	11.08	PR: 1KD,1KP						
	2.0 TFSI quattro	162		06.05	11.08	PR: 1KD,1KP						
	2.4	8E-4-180001			11.08	PR: 1KD,1KP						
	2.5 TDI	8E-4-180001			11.08	PR: 1KD,1KP						
	2.5 TDI quattro	8E-4-180001			11.08	PR: 1KD,1KP						
	3.0		8E-7-300000	12.00		PR: 1KD,1KP						
	3.0 quattro		8E-7-300000	12.00		PR: 1KD,1KP						
	1.6	75 8E-5-400001			11.08	PR: 1KW				G1020682	23914 17,1 /WD/Acc/S	LUC
	1.8 T	110 8E-5-400001			11.08	PR: 1KW						
1.8 T	120 8E-5-400001			11.08	PR: 1KW							
1.8 T	125 8E-5-400001			11.08	PR: 1KW							
1.8 T	140 8E-5-400001			11.08	PR: 1KW							
1.8 T quattro	110 8E-5-400001			11.08	PR: 1KW							
1.8 T quattro	120 8E-5-400001			11.08	PR: 1KW							
1.8 T quattro	125 8E-5-400001			11.08	PR: 1KW							
1.8 T quattro	140 8E-5-400001			11.08	PR: 1KW							
1.9 TDI	74 8E-5-400001			11.08	PR: 1KW							
1.9 TDI	85 8E-5-400001			11.08	PR: 1KW							
1.9 TDI	96 8E-5-400001			11.08	PR: 1KW							
1.9 TDI quattro	8E-5-400001			11.08	PR: 1KW							
2.0	96 8E-5-400001			11.08	PR: 1KW							
2.0 FSI	110 8E-5-400001			11.08	PR: 1KW							
2.0 TDI	100 8E-5-400001			11.08	PR: 1KW							
2.0 TDI	103 8E-5-400001			11.08	PR: 1KW							
2.0 TDI	125		06.06	11.08	PR: 1KW							
2.0 TDI quattro	103		01.06	11.08	PR: 1KW							
2.0 TDI quattro	125		06.06	11.08	PR: 1KW							
2.0 TFSI	147 8E-5-400001			11.08	PR: 1KW							
2.0 TFSI	162 8E-5-400001			11.08	PR: 1KW							
2.0 TFSI quattro	147 8E-5-400001			11.08	PR: 1KW							
2.0 TFSI quattro	162 8E-5-400001			11.08	PR: 1KW							
2.4	8E-5-400001			11.08	PR: 1KW							
2.5 TDI	8E-5-400001			11.08	PR: 1KW							
2.5 TDI quattro	8E-5-400001			11.08	PR: 1KW							
2.7 TDI	120		11.05	11.08	PR: 1KW							
2.7 TDI	132		01.06	11.08	PR: 1KW							
3.0	8E-5-400001			11.08	PR: 1KW							
3.0 quattro	8E-5-400001			11.08	PR: 1KW							
3.0 TDI quattro	150 8E-5-400001			11.08	PR: 1KW							
3.0 TDI quattro	171		01.06	11.08	PR: 1KW							
3.2 FSI	188 8E-5-400001			11.08	PR: 1KW							
3.2 FSI quattro	188 8E-5-400001			11.08	PR: 1KW							
S4 4.2	253		03.03	11.08		G1020758	23326 17,4 /WD/S	LUC				
S4 4.2	253		01.05	11.08		G1020759	23326 17,4 /WD/S	LUC				
	1.6	75		12.00	11.08	PR: 1KD	G2110261	245 10,0 8,0 +C				
	1.8 T	110		12.00	11.08	PR: 1KD						
	1.8 T	120		07.02	11.08	PR: 1KD						
	1.8 T	125		07.01	11.08	PR: 1KD						
	1.8 T	140		11.02	11.08	PR: 1KD						
	1.8 T quattro	110		12.00	11.08	PR: 1KD						
	1.8 T quattro	120		07.02	11.08	PR: 1KD						
	1.8 T quattro	125		07.01	11.08	PR: 1KD						
	1.8 T quattro	140		11.02	11.08	PR: 1KD						
	1.9 TDI	74		04.01	11.08	PR: 1KD						
	1.9 TDI	85		06.04	11.08	PR: 1KD						
	1.9 TDI	96		12.00	11.08	PR: 1KD						
	1.9 TDI quattro			12.00	11.08	PR: 1KD						
	2.0	96		12.00	11.08	PR: 1KD						
	2.0 FSI	110		07.02	11.08	PR: 1KD						
	2.0 TDI	100		11.04	11.08	PR: 1KD						
	2.0 TDI	103		11.04	11.08	PR: 1KD						
	2.0 TDI	125		06.06	11.08	PR: 1KD						
	2.0 TDI quattro	103		01.06	11.08	PR: 1KD						
	2.0 TDI quattro	125		06.06	11.08	PR: 1KD						
	2.0 TFSI	147		11.04	11.08	PR: 1KD						
	2.0 TFSI	162		06.05	11.08	PR: 1KD						
	2.0 TFSI quattro	147		11.04	11.08	PR: 1KD						
	2.0 TFSI quattro	162		06.05	11.08	PR: 1KD						
2.4			09.01	11.08	PR: 1KD							
2.5 TDI			12.00	11.08	PR: 1KD							
2.5 TDI quattro			12.00	11.08	PR: 1KD							
3.0 TDI quattro	150		11.04	11.08	PR: 1KD							
3.2 FSI	188		01.05	11.08	PR: 1KD							
3.2 FSI quattro	188		01.05	11.08	PR: 1KD							
<b>AUDI A4 (B8) Saloon (07-)</b>												
	1.8 TFSI	88		01.08		PR: 1LT,1LY	G1020823	24705 19,8 +/Wl	ATE			
	1.8 TFSI	118		11.07		PR: 1LT,1LY						
	1.8 TFSI	125		01.12		PR: 1LT,1LY						
	1.8 TFSI quattro	118		09.08		PR: 1LT,1LY						
	1.8 TFSI quattro	125		01.12		PR: 1LT,1LY						
	2.0 TDI	88		06.08		PR: 1LT,1LY						



**AUDI A4 (B8) Saloon (07-)**

	2.0 TDI	100	11.07	PR: 1LT,1LY	G1020823	24705 19,8 +/W/	ATE			
	2.0 TDI	105	11.07	PR: 1LT,1LY						
	2.0 TDI	110	05.13	PR: 1LT,1LY						
	2.0 TDI	120	08.08	PR: 1LT,1LY						
	2.0 TDI	125	01.08	PR: 1LT,1LY						
	2.0 TDI	130	11.11	PR: 1LT,1LY						
	2.0 TDI	140	09.13	PR: 1LT,1LY						
	2.0 TDI quattro	110	05.13	PR: 1LT,1LY						
	2.0 TDI quattro	125	01.08	PR: 1LT,1LY						
	2.0 TDI quattro	130	11.11	PR: 1LT,1LY						
	2.0 TDI quattro	140	09.13	PR: 1LT,1LY						
	2.0 TFSI	132	06.08	PR: 1LT,1LY						
	2.0 TFSI	155	06.08	PR: 1LT,1LY						
	2.0 TFSI	162	05.13	PR: 1LT,1LY						
	2.0 TFSI	165	05.13	PR: 1LT,1LY						
	2.0 TFSI quattro	132	11.09	PR: 1LT,1LY						
	2.0 TFSI quattro	155	06.08	PR: 1LT,1LY						
	2.0 TFSI quattro	162	05.13	PR: 1LT,1LY						
	2.0 TFSI quattro	165	05.13	PR: 1LT,1LY						
	2.7 TDI	120	11.07	PR: 1LT,1LY						
	2.7 TDI	140	11.07	PR: 1LT,1LY						
	3.0 TDI	150	11.11	PR: 1LT,1LY						
	3.0 TDI quattro	155	06.08	PR: 1LT,1LY						
	3.0 TDI quattro	176	11.07	PR: 1LT,1LY						
	3.0 TDI quattro	180	11.11	PR: 1LT,1LY						
	3.0 TFSI quattro	200	02.12	PR: 1LT,1LY						
	3.2 FSI	195	09.08	PR: 1LT,1LY						
	3.2 FSI quattro	195	11.07	PR: 1LT,1LY						
	1.8 TFSI	88	01.08	PR: 1LA,1LB,1LD				G1020983	24743 19,2 +/W/S	LUC
	1.8 TFSI	118	11.07	PR: 1LA,1LB,1LD						
	1.8 TFSI	125	01.12	PR: 1LA,1LB,1LD						
	1.8 TFSI quattro	118	09.08	PR: 1LA,1LB,1LD						
	1.8 TFSI quattro	125	01.12	PR: 1LA,1LB,1LD						
2.0 TDI	88	06.08	PR: 1LA,1LB,1LD							
2.0 TDI	100	11.07	PR: 1LA,1LB,1LD							
2.0 TDI	105	11.07	PR: 1LA,1LB,1LD							
2.0 TDI	110	05.13	PR: 1LA,1LB,1LD							
2.0 TDI	120	08.08	PR: 1LA,1LB,1LD							
2.0 TDI	125	01.08	PR: 1LA,1LB,1LD							
2.0 TDI	130	11.11	PR: 1LA,1LB,1LD							
2.0 TDI	140	09.13	PR: 1LA,1LB,1LD							
2.0 TDI quattro	110	05.13	PR: 1LA,1LB,1LD							
2.0 TDI quattro	125	01.08	PR: 1LA,1LB,1LD							
2.0 TDI quattro	130	11.11	PR: 1LA,1LB,1LD							
2.0 TDI quattro	140	09.13	PR: 1LA,1LB,1LD							
2.0 TFSI	132	06.08	PR: 1LA,1LB,1LD							
2.0 TFSI	155	06.08	PR: 1LA,1LB,1LD							
2.0 TFSI	162	05.13	PR: 1LA,1LB,1LD							
2.0 TFSI	165	05.13	PR: 1LA,1LB,1LD							
2.0 TFSI quattro	132	11.09	PR: 1LA,1LB,1LD							
2.0 TFSI quattro	155	06.08	PR: 1LA,1LB,1LD							
2.0 TFSI quattro	162	05.13	PR: 1LA,1LB,1LD							
2.0 TFSI quattro	165	05.13	PR: 1LA,1LB,1LD							
2.7 TDI	120	11.07	PR: 1LA,1LB,1LD							
2.7 TDI	140	11.07	PR: 1LA,1LB,1LD							
3.0 TDI	150	11.11	PR: 1LA,1LB,1LD							
3.0 TDI quattro	155	06.08	PR: 1LA,1LB,1LD							
3.0 TDI quattro	176	11.07	PR: 1LA,1LB,1LD							
3.0 TDI quattro	180	11.11	PR: 1LA,1LB,1LD							
3.0 TFSI quattro	200	02.12	PR: 1LA,1LB,1LD							
3.2 FSI	195	09.08	PR: 1LA,1LB,1LD							
3.2 FSI quattro	195	11.07	PR: 1LA,1LB,1LD							
S4	245	07.11	PR: 1LJ,1ZT	G1020983	24743 19,2 +/W/S	LUC				
	1.8 TFSI	88	01.08	PR: 1LT,1LY	G2125184	314 25,0 23,0 V L +S +C				
	1.8 TFSI	118	11.07	PR: 1LT,1LY						
	1.8 TFSI	125	01.12	PR: 1LT,1LY						
	1.8 TFSI quattro	118	09.08	PR: 1LT,1LY						
	1.8 TFSI quattro	125	01.12	PR: 1LT,1LY						
	2.0 TDI	88	06.08	PR: 1LT,1LY						
	2.0 TDI	100	11.07	PR: 1LT,1LY						
	2.0 TDI	105	11.07	PR: 1LT,1LY						
	2.0 TDI	110	05.13	PR: 1LT,1LY						
	2.0 TDI	120	08.08	PR: 1LT,1LY						
	2.0 TDI	125	01.08	PR: 1LT,1LY						
	2.0 TDI	130	11.11	PR: 1LT,1LY						
	2.0 TDI	140	09.13	PR: 1LT,1LY						
	2.0 TDI quattro	110	05.13	PR: 1LT,1LY						
	2.0 TDI quattro	125	01.08	PR: 1LT,1LY						
	2.0 TDI quattro	130	11.11	PR: 1LT,1LY						
	2.0 TDI quattro	140	09.13	PR: 1LT,1LY						
	2.0 TFSI	132	06.08	PR: 1LT,1LY						
	2.0 TFSI	155	06.08	PR: 1LT,1LY						
	2.0 TFSI	162	05.13	PR: 1LT,1LY						
	2.0 TFSI	165	05.13	PR: 1LT,1LY						
	2.0 TFSI quattro	132	11.09	PR: 1LT,1LY						
	2.0 TFSI quattro	155	06.08	PR: 1LT,1LY						
2.0 TFSI quattro	162	05.13	PR: 1LT,1LY							







**AUDI A4 (B8) Saloon (07-)**













	2.0 TDI	110	05.13	PR: 1KW,2EH	<b>G2112178</b>	electric parking brake <sup>1)</sup>	300 12,0 10,0 +S +C
	2.0 TDI	120	08.08	PR: 1KW,2EH			
	2.0 TDI	125	01.08	PR: 1KW,2EH			
	2.0 TDI	130	11.11	PR: 1KW,2EH			
	2.0 TDI	140	09.13	PR: 1KW,2EH			
	2.0 TDI quattro	110	05.13	PR: 1KW,2EH			
	2.0 TDI quattro	125	01.08	PR: 1KW,2EH			
	2.0 TDI quattro	130	11.11	PR: 1KW,2EH			
	2.0 TDI quattro	140	09.13	PR: 1KW,2EH			
	2.0 TFSI	132	06.08	PR: 1KW,2EH			
	2.0 TFSI	155	06.08	PR: 1KW,2EH			
	2.0 TFSI	162	05.13	PR: 1KW,2EH			
	2.0 TFSI	165	05.13	PR: 1KW,2EH			
	2.0 TFSI quattro	132	11.09	PR: 1KW,2EH			
	2.0 TFSI quattro	155	06.08	PR: 1KW,2EH			
	2.0 TFSI quattro	162	05.13	PR: 1KW,2EH			
	2.0 TFSI quattro	165	05.13	PR: 1KW,2EH			
	2.7 TDI	120	11.07	PR: 1KW,2EH			
	2.7 TDI	140	11.07	PR: 1KW,2EH			
	3.0 TDI	150	11.11	PR: 1KW,2EH			
	3.0 TDI quattro	155	06.08	PR: 1KW,2EH			
	3.0 TDI quattro	176	11.07	PR: 1KW,2EH			
	3.0 TDI quattro	180	11.11	PR: 1KW,2EH			
	3.0 TFSI quattro	200	02.12	PR: 1KW,2EH			
	3.2 FSI	195	09.08	PR: 1KW,2EH			
	3.2 FSI quattro	195	11.07	PR: 1KW,2EH			

**AUDI A4 (B8) Avant (08-)**

	1.8 FSI	88	04.08	PR: 1LT,1LY	<b>G1020823</b>	24705 19,8 +/WI	ATE
	1.8 TFSI	118	04.08	PR: 1LT,1LY			
	1.8 TFSI	125	01.12	PR: 1LT,1LY			
	1.8 TFSI quattro	118	09.08	PR: 1LT,1LY			
	1.8 TFSI quattro	125	01.12	PR: 1LT,1LY			
	2.0 TDI	88	06.08	PR: 1LT,1LY			
	2.0 TDI	100	04.08	PR: 1LT,1LY			
	2.0 TDI	105	04.08	PR: 1LT,1LY			
	2.0 TDI	110	05.13	PR: 1LT,1LY			
	2.0 TDI	125	04.08	PR: 1LT,1LY			
	2.0 TDI	130	11.11	PR: 1LT,1LY			
	2.0 TDI	140	09.13	PR: 1LT,1LY			
	2.0 TDI quattro	105	04.08	PR: 1LT,1LY			
	2.0 TDI quattro	110	05.13	PR: 1LT,1LY			
	2.0 TDI quattro	125	08.08	PR: 1LT,1LY			
	2.0 TDI quattro	130	11.11	PR: 1LT,1LY			
	2.0 TDI quattro	140	09.13	PR: 1LT,1LY			
	2.0 TFSI	132	06.08	PR: 1LT,1LY			
	2.0 TFSI	155	04.08	PR: 1LT,1LY			
	2.0 TFSI	165	05.13	PR: 1LT,1LY			
	2.0 TFSI quattro	132	11.09	PR: 1LT,1LY			
	2.0 TFSI quattro	155	04.08	PR: 1LT,1LY			
	2.0 TFSI quattro	165	05.13	PR: 1LT,1LY			
	2.7 TDI	120	06.08	PR: 1LT,1LY			
	2.7 TDI	140	06.08	PR: 1LT,1LY			
	3.0 TDI	150	11.11	PR: 1LT,1LY			
	3.0 TDI quattro	155	06.08	PR: 1LT,1LY			
	3.0 TDI quattro	176	04.08	PR: 1LT,1LY			
	3.0 TDI quattro	180	11.11	PR: 1LT,1LY			
	3.0 TFSI quattro	200	02.12	PR: 1LT,1LY			
	3.2 FSI	195	09.08	PR: 1LT,1LY			
	3.2 FSI quattro	195	04.08	PR: 1LT,1LY			
	1.8 FSI	88	04.08	PR: 1LA,1LB,1LD			
	1.8 TFSI	118	04.08	PR: 1LA,1LB,1LD			
	1.8 TFSI	125	01.12	PR: 1LA,1LB,1LD			
	1.8 TFSI quattro	118	09.08	PR: 1LA,1LB,1LD			
	1.8 TFSI quattro	125	01.12	PR: 1LA,1LB,1LD			
	2.0 TDI	88	06.08	PR: 1LA,1LB,1LD			
	2.0 TDI	100	04.08	PR: 1LA,1LB,1LD			
	2.0 TDI	105	04.08	PR: 1LA,1LB,1LD			
	2.0 TDI	110	05.13	PR: 1LA,1LB,1LD			
	2.0 TDI	125	04.08	PR: 1LA,1LB,1LD			
	2.0 TDI	130	11.11	PR: 1LA,1LB,1LD			
	2.0 TDI	140	09.13	PR: 1LA,1LB,1LD			
	2.0 TDI quattro	105	04.08	PR: 1LA,1LB,1LD			
	2.0 TDI quattro	110	05.13	PR: 1LA,1LB,1LD			
	2.0 TDI quattro	125	08.08	PR: 1LA,1LB,1LD			
	2.0 TDI quattro	130	11.11	PR: 1LA,1LB,1LD			
	2.0 TDI quattro	140	09.13	PR: 1LA,1LB,1LD			
	2.0 TFSI	132	06.08	PR: 1LA,1LB,1LD			
	2.0 TFSI	155	04.08	PR: 1LA,1LB,1LD			
	2.0 TFSI	165	05.13	PR: 1LA,1LB,1LD			
	2.0 TFSI quattro	132	11.09	PR: 1LA,1LB,1LD			
	2.0 TFSI quattro	155	04.08	PR: 1LA,1LB,1LD			
	2.0 TFSI quattro	165	05.13	PR: 1LA,1LB,1LD			
	2.7 TDI	120	06.08	PR: 1LA,1LB,1LD			
	2.7 TDI	140	06.08	PR: 1LA,1LB,1LD			
	3.0 TDI	150	11.11	PR: 1LA,1LB,1LD			
	3.0 TDI quattro	155	06.08	PR: 1LA,1LB,1LD			

<sup>1)</sup> fr.di stazionamento elettrico / frein à main électrique / freno de mano eléctrico / elektrische Feststellbremse



								
<b>AUDI A4 (B8) Avant (08-)</b>								
	3.0 TDI quattro	176	04.08	PR: 1LA,1LB,1LD	<b>G1020983</b>			24743 19,2 +/-W/S <b>LUC</b>
	3.0 TDI quattro	180	11.11	PR: 1LA,1LB,1LD				
	3.0 TFSI quattro	200	02.12	PR: 1LA,1LB,1LD				
	3.2 FSI	195	09.08	PR: 1LA,1LB,1LD				
	3.2 FSI quattro	195	04.08	PR: 1LA,1LB,1LD				
S4	245	07.11	PR: 1LJ,1ZT	<b>G1020983</b>			24743 19,2 +/-W/S <b>LUC</b>	
	1.8 FSI	88	04.08	PR: 1LT,1LY	<b>G2125184</b>			314 25,0 23,0 V L +S +C
	1.8 FSI	118	04.08	PR: 1LT,1LY				
	1.8 FSI	125	01.12	PR: 1LT,1LY				
	1.8 FSI quattro	118	09.08	PR: 1LT,1LY				
	1.8 FSI quattro	125	01.12	PR: 1LT,1LY				
	2.0 TDI	88	06.08	PR: 1LT,1LY				
	2.0 TDI	100	04.08	PR: 1LT,1LY				
	2.0 TDI	105	04.08	PR: 1LT,1LY				
	2.0 TDI	110	05.13	PR: 1LT,1LY				
	2.0 TDI	125	04.08	PR: 1LT,1LY				
	2.0 TDI	130	11.11	PR: 1LT,1LY				
	2.0 TDI	140	09.13	PR: 1LT,1LY				
	2.0 TDI quattro	105	04.08	PR: 1LT,1LY				
	2.0 TDI quattro	110	05.13	PR: 1LT,1LY				
	2.0 TDI quattro	125	08.08	PR: 1LT,1LY				
	2.0 TDI quattro	130	11.11	PR: 1LT,1LY				
	2.0 TDI quattro	140	09.13	PR: 1LT,1LY				
	2.0 TFSI	132	06.08	PR: 1LT,1LY				
	2.0 TFSI	155	04.08	PR: 1LT,1LY				
	2.0 TFSI	165	05.13	PR: 1LT,1LY				
	2.0 TFSI quattro	132	11.09	PR: 1LT,1LY				
	2.0 TFSI quattro	155	04.08	PR: 1LT,1LY				
	2.0 TFSI quattro	165	05.13	PR: 1LT,1LY				
	2.7 TDI	120	06.08	PR: 1LT,1LY				
	2.7 TDI	140	06.08	PR: 1LT,1LY				
	3.0 TDI	150	11.11	PR: 1LT,1LY				
	3.0 TDI quattro	155	06.08	PR: 1LT,1LY				
	3.0 TDI quattro	176	04.08	PR: 1LT,1LY				
3.0 TDI quattro	180	11.11	PR: 1LT,1LY					
3.0 TFSI quattro	200	02.12	PR: 1LT,1LY					
3.2 FSI	195	09.08	PR: 1LT,1LY					
3.2 FSI quattro	195	04.08	PR: 1LT,1LY					
	1.8 FSI	88	04.08	PR: 1KW,2EH	<b>G1201004</b>		electric parking brake <sup>1)</sup>	24606 17,4 +/-Acc/S <b>LUC</b>
	1.8 FSI	118	04.08	PR: 1KW,2EH				
	1.8 FSI	125	01.12	PR: 1KW,2EH				
	1.8 FSI quattro	118	09.08	PR: 1KW,2EH				
	1.8 FSI quattro	125	01.12	PR: 1KW,2EH				
	2.0 TDI	88	06.08	PR: 1KW,2EH				
	2.0 TDI	100	04.08	PR: 1KW,2EH				
	2.0 TDI	105	04.08	PR: 1KW,2EH				
	2.0 TDI	110	05.13	PR: 1KW,2EH				
	2.0 TDI	125	04.08	PR: 1KW,2EH				
	2.0 TDI	130	11.11	PR: 1KW,2EH				
	2.0 TDI	140	09.13	PR: 1KW,2EH				
	2.0 TDI quattro	105	04.08	PR: 1KW,2EH				
	2.0 TDI quattro	110	05.13	PR: 1KW,2EH				
	2.0 TDI quattro	125	08.08	PR: 1KW,2EH				
	2.0 TDI quattro	130	11.11	PR: 1KW,2EH				
	2.0 TDI quattro	140	09.13	PR: 1KW,2EH				
	2.0 TFSI	132	06.08	PR: 1KW,2EH				
	2.0 TFSI	155	04.08	PR: 1KW,2EH				
	2.0 TFSI	165	05.13	PR: 1KW,2EH				
	2.0 TFSI quattro	132	11.09	PR: 1KW,2EH				
	2.0 TFSI quattro	155	04.08	PR: 1KW,2EH				
	2.0 TFSI quattro	165	05.13	PR: 1KW,2EH				
	2.7 TDI	120	06.08	PR: 1KW,2EH				
	2.7 TDI	140	06.08	PR: 1KW,2EH				
	3.0 TDI	150	11.11	PR: 1KW,2EH				
	3.0 TDI quattro	155	06.08	PR: 1KW,2EH				
	3.0 TDI quattro	176	04.08	PR: 1KW,2EH				
3.0 TDI quattro	180	11.11	PR: 1KW,2EH					
3.0 TFSI quattro	200	02.12	PR: 1KW,2EH					
3.2 FSI	195	09.08	PR: 1KW,2EH					
3.2 FSI quattro	195	04.08	PR: 1KW,2EH					
S4	245	11.08	PR: 1KE	<b>G1201005</b>		electric parking brake <sup>1)</sup>	24606 17,4 +/-Acc/S <b>LUC</b>	
	1.8 FSI	88	04.08	PR: 1KP	<b>G1201005</b>		electric parking brake <sup>1)</sup>	24606 17,4 +/-Acc/S <b>LUC</b>
	1.8 FSI	118	04.08	PR: 1KP				
	1.8 FSI	125	01.12	PR: 1KP				
	1.8 FSI quattro	118	09.08	PR: 1KP				
	1.8 FSI quattro	125	01.12	PR: 1KP				
	2.0 TDI	88	06.08	PR: 1KP				
	2.0 TDI	100	04.08	PR: 1KP				
	2.0 TDI	105	04.08	PR: 1KP				
	2.0 TDI	110	05.13	PR: 1KP				
	2.0 TDI	125	04.08	PR: 1KP				
	2.0 TDI	130	11.11	PR: 1KP				
	2.0 TDI	140	09.13	PR: 1KP				
	2.0 TDI quattro	105	04.08	PR: 1KP				
	2.0 TDI quattro	110	05.13	PR: 1KP				
	2.0 TDI quattro	125	08.08	PR: 1KP				
2.0 TDI quattro	130	11.11	PR: 1KP					

<sup>1)</sup> fr.di stazionamento elettrico / frein à main électrique / freno de mano eléctrico / elektrische Feststellbremse



AUDI A4 (B8) Avant (08-)								
	2.0 TDI quattro	140	09.13	PR: 1KP	G1201005	electric parking brake <sup>1)</sup>	24606 17,4 +/Acc/S	LUC
	2.0 TDI quattro	140	09.13	PR: 1KP				
	2.0 TFSI	132	06.08	PR: 1KP				
	2.0 TFSI	155	04.08	PR: 1KP				
	2.0 TFSI	165	05.13	PR: 1KP				
	2.0 TFSI quattro	132	11.09	PR: 1KP				
	2.0 TFSI quattro	155	04.08	PR: 1KP				
	2.7 TDI	120	06.08	PR: 1KP				
	2.7 TDI	140	06.08	PR: 1KP				
	3.0 TDI	150	11.11	PR: 1KP				
	3.0 TDI quattro	155	06.08	PR: 1KP				
	3.0 TDI quattro	176	04.08	PR: 1KP				
	3.0 TDI quattro	180	11.11	PR: 1KP				
	3.0 TFSI quattro	200	02.12	PR: 1KP				
	3.2 FSI	195	09.08	PR: 1KP				
	3.2 FSI quattro	195	04.08	PR: 1KP				
	1.8 FSI	88	04.08	PR: 1KW,2EH	G2112178	electric parking brake <sup>1)</sup>	300 12,0 10,0 +S +C	
	1.8 TFSI	118	04.08	PR: 1KW,2EH				
	1.8 TFSI	125	01.12	PR: 1KW,2EH				
	1.8 TFSI quattro	118	09.08	PR: 1KW,2EH				
	1.8 TFSI quattro	125	01.12	PR: 1KW,2EH				
	2.0 TDI	88	06.08	PR: 1KW,2EH				
	2.0 TDI	100	04.08	PR: 1KW,2EH				
	2.0 TDI	105	04.08	PR: 1KW,2EH				
	2.0 TDI	110	05.13	PR: 1KW,2EH				
	2.0 TDI	125	04.08	PR: 1KW,2EH				
	2.0 TDI	130	11.11	PR: 1KW,2EH				
	2.0 TDI	140	09.13	PR: 1KW,2EH				
	2.0 TDI quattro	105	04.08	PR: 1KW,2EH				
	2.0 TDI quattro	110	05.13	PR: 1KW,2EH				
	2.0 TDI quattro	125	08.08	PR: 1KW,2EH				
	2.0 TDI quattro	130	11.11	PR: 1KW,2EH				
	2.0 TDI quattro	140	09.13	PR: 1KW,2EH				
	2.0 TFSI	132	06.08	PR: 1KW,2EH				
	2.0 TFSI	155	04.08	PR: 1KW,2EH				
	2.0 TFSI	165	05.13	PR: 1KW,2EH				
	2.0 TFSI quattro	132	11.09	PR: 1KW,2EH				
	2.0 TFSI quattro	155	04.08	PR: 1KW,2EH				
	2.0 TFSI quattro	165	05.13	PR: 1KW,2EH				
	2.7 TDI	120	06.08	PR: 1KW,2EH				
	2.7 TDI	140	06.08	PR: 1KW,2EH				
	3.0 TDI	150	11.11	PR: 1KW,2EH				
	3.0 TDI quattro	155	06.08	PR: 1KW,2EH				
	3.0 TDI quattro	176	04.08	PR: 1KW,2EH				
	3.0 TDI quattro	180	11.11	PR: 1KW,2EH				
	3.0 TFSI quattro	200	02.12	PR: 1KW,2EH				
	3.2 FSI	195	09.08	PR: 1KW,2EH				
	3.2 FSI quattro	195	04.08	PR: 1KW,2EH				
AUDI A4 Allroad (09-)								
	2.0 TDI quattro	105	09.09	PR: 1LT	G1020823		24705 19,8 +/W/L	ATE
	2.0 TDI quattro	110	05.13	PR: 1LT				
	2.0 TDI quattro	120	04.09	PR: 1LT				
	2.0 TDI quattro	125	02.09	PR: 1LT				
	2.0 TDI quattro	130	01.12	PR: 1LT				
	2.0 TFSI quattro	155	04.09	PR: 1LT				
	2.0 TFSI quattro	162	05.13	PR: 1LT				
	2.0 TFSI quattro	165	04.13	PR: 1LT				
	3.0 TDI quattro	176	04.09	PR: 1LT				
	3.0 TDI quattro	180	01.12	PR: 1LT				
	2.0 TDI quattro	105	09.09	PR: 1LA	G1020983		24743 19,2 +/W/S	LUC
	2.0 TDI quattro	110	05.13	PR: 1LA				
	2.0 TDI quattro	120	04.09	PR: 1LA				
	2.0 TDI quattro	125	02.09	PR: 1LA				
	2.0 TDI quattro	130	01.12	PR: 1LA				
	2.0 TFSI quattro	155	04.09	PR: 1LA				
	2.0 TFSI quattro	162	05.13	PR: 1LA				
	2.0 TFSI quattro	165	04.13	PR: 1LA				
	3.0 TDI quattro	176	04.09	PR: 1LA				
	3.0 TDI quattro	180	01.12	PR: 1LA				
	2.0 TDI quattro	105	09.09	PR: 1LT	G2125184		314 25,0 23,0 V L +S +C	
	2.0 TDI quattro	110	05.13	PR: 1LT				
	2.0 TDI quattro	120	04.09	PR: 1LT				
	2.0 TDI quattro	125	02.09	PR: 1LT				
	2.0 TDI quattro	130	01.12	PR: 1LT				
	2.0 TFSI quattro	155	04.09	PR: 1LT				
	2.0 TFSI quattro	162	05.13	PR: 1LT				
	2.0 TFSI quattro	165	04.13	PR: 1LT				
	3.0 TDI quattro	176	04.09	PR: 1LT				
	3.0 TDI quattro	180	01.12	PR: 1LT				
	2.0 TDI quattro	105	09.09	PR: 1KW,GP0,GP1,GP2	G1201004		24606 17,4 +/Acc/S	LUC
	2.0 TDI quattro	110	05.13	PR: 1KW,GP0,GP1,GP2				
	2.0 TDI quattro	120	04.09	PR: 1KW,GP0,GP1,GP2				
	2.0 TDI quattro	125	02.09	PR: 1KW,GP0,GP1,GP2				
	2.0 TDI quattro	130	01.12	PR: 1KW,GP0,GP1,GP2				
	2.0 TFSI quattro	155	04.09	PR: 1KW,GP0,GP1,GP2				
	2.0 TFSI quattro	162	05.13	PR: 1KW,GP0,GP1,GP2				
	2.0 TFSI quattro	162	05.13	PR: 1KW,GP0,GP1,GP2				

<sup>1)</sup> fr.di stazionamento elettrico / frein à main électrique / freno de mano eléctrico / elektrische Feststellbremse





**AUDI A4 Allroad (09-)**

	2.0 TFSI quattro	165		<b>04.13</b>	PR: 1KW,GP0,GP1,GP2	<b>G1201004</b>		<b>24606</b> 17,4 +/Acc/S	<b>LUC</b>
	3.0 TDI quattro	176		<b>04.09</b>	PR: 1KW,GP0,GP1,GP2				
	3.0 TDI quattro	180		<b>01.12</b>	PR: 1KW,GP0,GP1,GP2				
	2.0 TDI quattro	105		<b>09.09</b>	PR: 1KW,GP0,GP1,GP2	<b>G2112178</b>		300 12,0 10,0 +S +C	
	2.0 TDI quattro	110		<b>05.13</b>	PR: 1KW,GP0,GP1,GP2				
	2.0 TDI quattro	120		<b>04.09</b>	PR: 1KW,GP0,GP1,GP2				
	2.0 TDI quattro	125		<b>02.09</b>	PR: 1KW,GP0,GP1,GP2				
	2.0 TDI quattro	130		<b>01.12</b>	PR: 1KW,GP0,GP1,GP2				
	2.0 TFSI quattro	155		<b>04.09</b>	PR: 1KW,GP0,GP1,GP2				
	2.0 TFSI quattro	162		<b>05.13</b>	PR: 1KW,GP0,GP1,GP2				
	2.0 TFSI quattro	165		<b>04.13</b>	PR: 1KW,GP0,GP1,GP2				
	3.0 TDI quattro	176		<b>04.09</b>	PR: 1KW,GP0,GP1,GP2				
	3.0 TDI quattro	180		<b>01.12</b>	PR: 1KW,GP0,GP1,GP2				

**AUDI A4 Convertible (02-08)**

	1.8 T	120		<b>04.02</b>	<b>11.08</b> PR: 1LB,1LE,1LF,1LT	<b>G1020313</b>		<b>23018</b> 20,3 +/WI	<b>ATE</b>
	1.8 T quattro	120		<b>05.03</b>	<b>11.08</b> PR: 1LB,1LE,1LF,1LT				
	2.0	96		<b>05.04</b>	<b>11.08</b> PR: 1LB,1LE,1LF,1LT				
	2.0 TDI			<b>10.05</b>	<b>11.08</b> PR: 1LB,1LE,1LF,1LT				
	2.0 TFSI	120		<b>10.05</b>	<b>11.08</b> PR: 1LB,1LE,1LF,1LT				
	2.0 TFSI	147		<b>01.06</b>	<b>11.08</b> PR: 1LB,1LE,1LF,1LT				
	2.0 TFSI quattro	147		<b>11.05</b>	<b>11.08</b> PR: 1LB,1LE,1LF,1LT				
	2.4	120		<b>04.02</b>	<b>11.08</b> PR: 1LB,1LE,1LF,1LT				
	2.4	125		<b>04.02</b>	<b>11.08</b> PR: 1LB,1LE,1LF,1LT				
	2.5 TDI	120		<b>08.02</b>	<b>11.08</b> PR: 1LB,1LE,1LF,1LT				
	2.7 TDI	132		<b>06.06</b>	<b>11.08</b> PR: 1LB,1LE,1LF,1LT				
	3.0	162		<b>04.02</b>	<b>11.08</b> PR: 1LB,1LE,1LF,1LT				
	3.0 quattro	162		<b>05.03</b>	<b>11.08</b> PR: 1LB,1LE,1LF,1LT				
	3.0 TDI quattro	150		<b>01.06</b>	<b>11.08</b> PR: 1LB,1LE,1LF,1LT				
	3.0 TDI quattro	171		<b>10.05</b>	<b>11.08</b> PR: 1LB,1LE,1LF,1LT				
	3.2 FSI	188		<b>10.05</b>	<b>11.08</b> PR: 1LB,1LE,1LF,1LT				
	3.2 FSI quattro	188		<b>10.05</b>	<b>11.08</b> PR: 1LB,1LE,1LF,1LT				
		1.8 T	120		<b>04.02</b>				
1.8 T quattro		120		<b>05.03</b>	<b>11.08</b> PR: 1LA				
2.0		96		<b>05.04</b>	<b>11.08</b> PR: 1LA				
2.0 TDI				<b>10.05</b>	<b>11.08</b> PR: 1LA				
2.0 TFSI		120		<b>10.05</b>	<b>11.08</b> PR: 1LA				
2.0 TFSI		147		<b>01.06</b>	<b>11.08</b> PR: 1LA				
2.0 TFSI quattro		147		<b>11.05</b>	<b>11.08</b> PR: 1LA				
2.4		120		<b>04.02</b>	<b>11.08</b> PR: 1LA				
2.4		125		<b>04.02</b>	<b>11.08</b> PR: 1LA				
2.5 TDI		120		<b>08.02</b>	<b>11.08</b> PR: 1LA				
2.7 TDI		132		<b>06.06</b>	<b>11.08</b> PR: 1LA				
3.0		162		<b>04.02</b>	<b>11.08</b> PR: 1LA				
3.0 quattro		162		<b>05.03</b>	<b>11.08</b> PR: 1LA				
3.0 TDI quattro		150		<b>01.06</b>	<b>11.08</b> PR: 1LA				
3.0 TDI quattro		171		<b>10.05</b>	<b>11.08</b> PR: 1LA				
3.2 FSI		188		<b>10.05</b>	<b>11.08</b> PR: 1LA				
3.2 FSI quattro		188		<b>10.05</b>	<b>11.08</b> PR: 1LA				
S4 4.2 quattro		253		<b>02.04</b>	<b>11.08</b>	<b>G1020754</b>		<b>23763</b> 20,3 +/WI	<b>ATE</b>
	1.8 T	120		<b>04.02</b>	<b>11.08</b> PR: 1LB,1LE	<b>G2125105</b>		288 25,0 23,0 V L +C	
	1.8 T quattro	120		<b>05.03</b>	<b>11.08</b> PR: 1LB,1LE				
	2.0	96		<b>05.04</b>	<b>11.08</b> PR: 1LB,1LE				
	2.0 TDI			<b>10.05</b>	<b>11.08</b> PR: 1LB,1LE				
	2.0 TFSI	120		<b>10.05</b>	<b>11.08</b> PR: 1LB,1LE				
	2.4	120		<b>04.02</b>	<b>11.08</b> PR: 1LB,1LE				
	2.4	125		<b>04.02</b>	<b>11.08</b> PR: 1LB,1LE				
	2.5 TDI	120		<b>08.02</b>	<b>11.08</b> PR: 1LB,1LE				
	2.0 TFSI	147		<b>01.06</b>	<b>11.08</b> PR: 1LB,1LE				
	2.0 TFSI quattro	147		<b>11.05</b>	<b>11.08</b> PR: 1LB,1LE				
	2.7 TDI	132		<b>06.06</b>	<b>11.08</b> PR: 1LB,1LE				
	3.0	162		<b>04.02</b>	<b>11.08</b> PR: 1LB,1LE				
	3.0 quattro	162		<b>05.03</b>	<b>11.08</b> PR: 1LB,1LE				
	3.0 TDI quattro	150		<b>01.06</b>	<b>11.08</b> PR: 1LB,1LE				
	3.0 TDI quattro	171		<b>10.05</b>	<b>11.08</b> PR: 1LB,1LE				
	3.2 FSI	188		<b>10.05</b>	<b>11.08</b> PR: 1LB,1LE				
	3.2 FSI quattro	188		<b>10.05</b>	<b>11.08</b> PR: 1LB,1LE				
		1.8 T	120		<b>04.02</b>				
1.8 T quattro		120		<b>05.03</b>	<b>11.08</b> PR: 1LF,1LT				
2.0		96		<b>05.04</b>	<b>11.08</b> PR: 1LF,1LT				
2.0 TDI				<b>10.05</b>	<b>11.08</b> PR: 1LF,1LT				
2.0 TFSI		120		<b>10.05</b>	<b>11.08</b> PR: 1LF,1LT				
2.4		120		<b>04.02</b>	<b>11.08</b> PR: 1LF,1LT				
2.4		125		<b>04.02</b>	<b>11.08</b> PR: 1LF,1LT				
2.5 TDI		120		<b>08.02</b>	<b>11.08</b> PR: 1LF,1LT				
2.0 TFSI		147		<b>01.06</b>	<b>11.08</b> PR: 1LF,1LT				
2.0 TFSI quattro		147		<b>11.05</b>	<b>11.08</b> PR: 1LF,1LT				
2.7 TDI		132		<b>06.06</b>	<b>11.08</b> PR: 1LF,1LT				
3.0		162		<b>04.02</b>	<b>11.08</b> PR: 1LF,1LT				
3.0 quattro		162		<b>05.03</b>	<b>11.08</b> PR: 1LF,1LT				
3.0 TDI quattro		150		<b>01.06</b>	<b>11.08</b> PR: 1LF,1LT				
3.0 TDI quattro		171		<b>10.05</b>	<b>11.08</b> PR: 1LF,1LT				
3.2 FSI		188		<b>10.05</b>	<b>11.08</b> PR: 1LF,1LT				
3.2 FSI quattro		188		<b>10.05</b>	<b>11.08</b> PR: 1LF,1LT				
		1.8 T	120		<b>04.02</b>	<b>11.08</b> PR: 1LA	<b>G2130113</b>		320 30,0 28,0 V L +C
	1.8 T quattro	120		<b>05.03</b>	<b>11.08</b> PR: 1LA				



### AUDI A4 Convertible (02-08)

	2.0	96		05.04	11.08	PR: 1LA	G2130113		320 30,0 28,0 V L +C					
	2.0 TDI			10.05	11.08	PR: 1LA								
	2.0 TFSI	120		10.05	11.08	PR: 1LA								
	2.0 TFSI	147		01.06	11.08	PR: 1LA								
	2.0 TFSI quattro	147		11.05	11.08	PR: 1LA								
	2.4	120		04.02	11.08	PR: 1LA								
	2.4	125		04.02	11.08	PR: 1LA								
	2.5 TDI	120		08.02	11.08	PR: 1LA								
	2.7 TDI	132		06.06	11.08	PR: 1LA								
	3.0	162		04.02	11.08	PR: 1LA								
	3.0 quattro	162		05.03	11.08	PR: 1LA								
	3.0 TDI quattro	150		01.06	11.08	PR: 1LA								
	3.0 TDI quattro	171		10.05	11.08	PR: 1LA								
	3.2 FSI	188		10.05	11.08	PR: 1LA								
	3.2 FSI quattro	188		10.05	11.08	PR: 1LA								
	1.8 T	120		04.02	11.08	PR: 1KD,1KP	G1020676		20961 15,8 /S	LUC				
	1.8 T quattro	120		05.03	11.08	PR: 1KD,1KP								
	2.0	96		05.04	11.08	PR: 1KD,1KP								
	2.0 TDI			10.05	11.08	PR: 1KD,1KP								
	2.0 TFSI	120		10.05	11.08	PR: 1KD,1KP								
	2.0 TFSI	147		01.06	11.08	PR: 1KD,1KP								
	2.0 TFSI quattro	147		11.05	11.08	PR: 1KD,1KP								
	2.4	120		04.02	12.05	PR: 1KD,1KP								
	2.4	125		04.02	12.05	PR: 1KD,1KP								
	2.5 TDI	120		08.02	12.05	PR: 1KD,1KP								
	3.0	162		04.02	12.05	PR: 1KD,1KP								
	3.0 quattro	162		05.03	12.05	PR: 1KD,1KP								
	1.8 T	120	8E-5-400001		11.08	PR: 1KW					G1020682		23914 17,1 /WD/Acc/S	LUC
	1.8 T quattro	120	8E-5-400001		11.08	PR: 1KW								
	2.0	96	8E-5-400001		11.08	PR: 1KW								
	2.0 TDI		8E-5-400001		11.08	PR: 1KW								
	2.0 TFSI	120	8E-5-400001		11.08	PR: 1KW								
	2.0 TFSI	147	8E-5-400001		11.08	PR: 1KW								
	2.0 TFSI quattro	147	8E-5-400001		11.08	PR: 1KW								
	2.4	120	8E-5-400001		11.08	PR: 1KW								
	2.4	125	8E-5-400001		11.08	PR: 1KW								
	2.5 TDI	120	8E-5-400001		11.08	PR: 1KW								
	2.7 TDI	132	8E-5-400001		11.08	PR: 1KW								
	3.0	162	8E-5-400001		11.08	PR: 1KW								
	3.0 quattro	162	8E-5-400001		11.08	PR: 1KW								
3.0 TDI quattro	150		01.06	11.08	PR: 1KW									
3.0 TDI quattro	171	8E-5-400001		11.08	PR: 1KW									
3.2 FSI	188	8E-5-400001		11.08	PR: 1KW									
3.2 FSI quattro	188	8E-5-400001		11.08	PR: 1KW									
S4 4.2 quattro	253		02.04	11.08										
	1.8 T	120		04.02	11.08	PR: 1KD	G2110261		245 10,0 8,0 +C					
	1.8 T quattro	120		05.03	11.08	PR: 1KD								
	2.0	96		05.04	11.08	PR: 1KD								
	2.0 TDI			10.05	11.08	PR: 1KD								
	2.0 TFSI	120		10.05	11.08	PR: 1KD								
	2.0 TFSI quattro	147		01.06	11.08	PR: 1KD								
2.0 TFSI quattro	147		11.05	11.08	PR: 1KD									

### AUDI A5 / A5 Sportback (07-)

	1.8 TFSI	118		05.09		PR: 1LT	G1020823		24705 19,8 +/WI	ATE
	1.8 TFSI	125		10.07		PR: 1LT				
	2.0 TDI	105		09.09		PR: 1LT				
	2.0 TDI	110		05.13		PR: 1LT				
	2.0 TDI	120		10.08		PR: 1LT				
	2.0 TDI	125		08.08		PR: 1LT				
	2.0 TDI	130		07.11		PR: 1LT				
	2.0 TDI quattro	124		10.08		PR: 1LT				
	2.0 TDI quattro	125		08.08		PR: 1LT				
	2.0 TDI quattro	130		12.11		PR: 1LT				
	2.0 TFSI	132		11.08		PR: 1LT				
	2.0 TFSI	155		06.08		PR: 1LT				
	2.0 TFSI	165		05.13		PR: 1LT				
	2.0 TFSI quattro	155		06.08		PR: 1LT				
	2.0 TFSI quattro	165		05.13		PR: 1LT				
	2.7 TDI	120		09.07		PR: 1LT				
	2.7 TDI	140		05.07		PR: 1LT				
	3.0 TDI	150		07.11		PR: 1LT				
	3.0 TDI quattro	155		03.08		PR: 1LT				
	3.0 TDI quattro	176		05.07		PR: 1LT				
3.0 TDI quattro	180		07.11		PR: 1LT					
3.0 TFSI quattro	200		12.11		PR: 1LT					
3.2 FSI	195		05.07		PR: 1LT					
3.2 FSI quattro	195		05.07		PR: 1LT					
	1.8 TFSI	118		05.09		PR: 1LA	G1020983		24743 19,2 +/WI/S	LUC
	1.8 TFSI	125		10.07		PR: 1LA				
	2.0 TDI	105		07.07		PR: 1LA				
	2.0 TDI	105		09.09		PR: 1LA				
	2.0 TDI	110		05.13		PR: 1LA				
	2.0 TDI	120		10.08		PR: 1LA				
	2.0 TDI	125		08.08		PR: 1LA				
	2.0 TDI	130		07.11		PR: 1LA				
	2.0 TDI quattro	124		10.08		PR: 1LA				







**AUDI A5 / A5 Sportback (07-)**

	2.0 TDI quattro	125		08.08	PR: 1LA	G1020983		24743 19,2 +/W/S	LUC					
	2.0 TDI quattro	130		12.11	PR: 1LA									
	2.0 TFSI	132		11.08	PR: 1LA									
	2.0 TFSI	155		06.08	PR: 1LA									
	2.0 TFSI	165		05.13	PR: 1LA									
	2.0 TFSI quattro	155		06.08	PR: 1LA									
	2.0 TFSI quattro	165		05.13	PR: 1LA									
	2.7 TDI	120		09.07	PR: 1LA									
	2.7 TDI	140		07.07	PR: 1LA									
	3.0 TDI	150		07.11	PR: 1LA									
	3.0 TDI quattro	155		03.08	PR: 1LA									
	3.0 TDI quattro	176		07.07	PR: 1LA									
	3.0 TDI quattro	180		07.11	PR: 1LA									
	3.0 TFSI quattro	200		12.11	PR: 1LA									
	3.2 FSI	195		07.07	PR: 1LA									
	S5 quattro	245		07.11	PR: 1LJ					G1020983		24743 19,2 +/W/S	LUC	
	S5 quattro	260		07.11	PR: 1LJ									
		1.8 TFSI	118		05.09					PR: 1LD	G1020983		24743 19,2 +/W/S	LUC
		1.8 TFSI	125		10.07					PR: 1LD				
		2.0 TDI	105		09.09					PR: 1LD				
2.0 TDI		110		05.13	PR: 1LD									
2.0 TDI		120		10.08	PR: 1LD									
2.0 TDI		125		08.08	PR: 1LD									
2.0 TDI		130		07.11	PR: 1LD									
2.0 TDI quattro		124		10.08	PR: 1LD									
2.0 TDI quattro		125		08.08	PR: 1LD									
2.0 TDI quattro		130		12.11	PR: 1LD									
2.0 TFSI		132		11.08	PR: 1LD									
2.0 TFSI		155		06.08	PR: 1LD									
2.0 TFSI		165		05.13	PR: 1LD									
2.0 TFSI quattro		155		06.08	PR: 1LD									
2.0 TFSI quattro		165		05.13	PR: 1LD									
2.7 TDI		120		09.07	PR: 1LD									
2.7 TDI		140		05.07	PR: 1LD									
3.0 TDI		150		07.11	PR: 1LD									
3.0 TDI quattro		155		03.08	PR: 1LD									
3.0 TDI quattro		176		05.07	PR: 1LD									
3.0 TDI quattro	180		07.11	PR: 1LD										
3.0 TFSI quattro	200		12.11	PR: 1LD										
3.2 FSI	195		05.07	PR: 1LD										
3.2 FSI quattro	195		05.07	PR: 1LD										
S5 quattro	245		01.10	PR: 12T,1LD	G1020983		24743 19,2 +/W/S	LUC						
S5 quattro	260		05.07	PR: 12T,1LD										
	1.8 TFSI	118		05.09	PR: 1LT	G2125184		314 25,0 23,0 V L +S +C						
	1.8 TFSI	125		10.07	PR: 1LT									
	2.0 TDI	105		09.09	PR: 1LT									
	2.0 TDI	110		05.13	PR: 1LT									
	2.0 TDI	120		10.08	PR: 1LT									
	2.0 TDI	125		08.08	PR: 1LT									
	2.0 TDI	130		07.11	PR: 1LT									
	2.0 TDI quattro	124		10.08	PR: 1LT									
	2.0 TDI quattro	125		08.08	PR: 1LT									
	2.0 TDI quattro	130		12.11	PR: 1LT									
	2.0 TFSI	132		11.08	PR: 1LT									
	2.0 TFSI	155		06.08	PR: 1LT									
	2.0 TFSI	165		05.13	PR: 1LT									
	2.0 TFSI quattro	155		06.08	PR: 1LT									
	2.0 TFSI quattro	165		05.13	PR: 1LT									
	2.7 TDI	120		09.07	PR: 1LT									
	2.7 TDI	140		05.07	PR: 1LT									
	3.0 TDI	150		07.11	PR: 1LT									
	3.0 TDI quattro	155		03.08	PR: 1LT									
	3.0 TDI quattro	176		05.07	PR: 1LT									
3.0 TDI quattro	180		07.11	PR: 1LT										
3.0 TFSI quattro	200		12.11	PR: 1LT										
3.2 FSI	195		05.07	PR: 1LT										
3.2 FSI quattro	195		06.07	PR: 1LT										
	1.8 TFSI	118		05.09	PR: 1KW,2EH	G1201004		24606 17,4 +/Acc/S	LUC					
	1.8 TFSI	125		10.07	PR: 1KW,2EH									
	2.0 TDI	105		09.09	PR: 1KW,2EH									
	2.0 TDI	110		05.13	PR: 1KW,2EH									
	2.0 TDI	120		10.08	PR: 1KW,2EH									
	2.0 TDI	125		08.08	PR: 1KW,2EH									
	2.0 TDI	130		07.11	PR: 1KW,2EH									
	2.0 TDI quattro	124		10.08	PR: 1KW,2EH									
	2.0 TDI quattro	125		08.08	PR: 1KW,2EH									
	2.0 TDI quattro	130		12.11	PR: 1KW,2EH									
	2.0 TFSI	132		11.08	PR: 1KW,2EH									
	2.0 TFSI	155		06.08	PR: 1KW,2EH									
	2.0 TFSI	165		05.13	PR: 1KW,2EH									
	2.0 TFSI quattro	155		06.08	PR: 1KW,2EH									
	2.0 TFSI quattro	165		05.13	PR: 1KW,2EH									
	2.7 TDI	120		09.07	PR: 1KW,2EH									
	2.7 TDI	140		05.07	PR: 1KW,2EH									
	3.0 TDI	150		07.11	PR: 1KW,2EH									
	3.0 TDI quattro	155		03.08	PR: 1KW,2EH									
	3.0 TDI quattro	176		05.07	PR: 1KW,2EH									



**AUDI A5 / A5 Sportback (07-)**

	3.0 TDI quattro	180	07.11	PR: 1KW,2EH	G1201004		24606 17,4 +/Acc/S	LUC				
	3.0 TFSI quattro	200	12.11	PR: 1KW,2EH								
	3.2 FSI	195	05.07	PR: 1KW,2EH								
	3.2 FSI quattro	195	06.07	PR: 1KW,2EH								
	1.8 TFSI	118	05.09	PR: 1KE					G1201005		24606 17,4 +/Acc/S	LUC
	1.8 TFSI	125	10.07	PR: 1KE								
	2.0 TDI	105	09.09	PR: 1KE								
	2.0 TDI	110	05.13	PR: 1KE								
	2.0 TDI	120	10.08	PR: 1KE								
	2.0 TDI	125	08.08	PR: 1KE								
	2.0 TDI	130	07.11	PR: 1KE								
	2.0 TDI quattro	124	10.08	PR: 1KE								
	2.0 TDI quattro	125	08.08	PR: 1KE								
	2.0 TDI quattro	130	12.11	PR: 1KE								
	2.0 TFSI	132	11.08	PR: 1KE								
	2.0 TFSI	155	06.08	PR: 1KE								
	2.0 TFSI	165	05.13	PR: 1KE								
	2.0 TFSI quattro	155	06.08	PR: 1KE								
	2.0 TFSI quattro	165	05.13	PR: 1KE								
	2.7 TDI	120	09.07	PR: 1KE								
2.7 TDI	140	05.07	PR: 1KE									
3.0 TDI	150	07.11	PR: 1KE									
3.0 TDI quattro	155	03.08	PR: 1KE									
3.0 TDI quattro	176	05.07	PR: 1KE									
3.0 TDI quattro	180	07.11	PR: 1KE									
3.0 TFSI quattro	200	12.11	PR: 1KE									
3.2 FSI	195	05.07	PR: 1KE									
3.2 FSI quattro	195	05.07	PR: 1KE									
RS 5	331	03.10	PR: GP1									
S5 quattro	245	01.10	10.10 PR: 1KE									
S5 quattro	260	05.07	10.10 PR: 1KE									
1.8 TFSI	118	05.09	PR: 1KP	G1201005		24606 17,4 +/Acc/S	LUC					
1.8 TFSI	125	10.07	PR: 1KP									
2.0 TDI	105	09.09	PR: 1KP									
2.0 TDI	110	05.13	PR: 1KP									
2.0 TDI	120	10.08	PR: 1KP									
2.0 TDI	125	08.08	PR: 1KP									
2.0 TDI	130	07.11	PR: 1KP									
2.0 TDI quattro	124	10.08	PR: 1KP									
2.0 TDI quattro	125	08.08	PR: 1KP									
2.0 TDI quattro	130	12.11	PR: 1KP									
2.0 TFSI	132	11.08	PR: 1KP									
2.0 TFSI	155	06.08	PR: 1KP									
2.0 TFSI	165	05.13	PR: 1KP									
2.0 TFSI quattro	155	06.08	PR: 1KP									
2.0 TFSI quattro	165	05.13	PR: 1KP									
2.7 TDI	120	09.07	PR: 1KP									
2.7 TDI	140	05.07	PR: 1KP									
3.0 TDI	150	07.11	PR: 1KP									
3.0 TDI quattro	155	03.08	PR: 1KP									
3.0 TDI quattro	176	05.07	PR: 1KP									
3.0 TDI quattro	180	07.11	PR: 1KP									
3.0 TFSI quattro	200	12.11	PR: 1KP									
3.2 FSI	195	05.07	PR: 1KP									
3.2 FSI quattro	195	05.07	PR: 1KP									
RS 5	331	03.10	PR: 1KP									
S5 quattro	245	11.10	PR: 1KE,1KP									
S5 quattro	260	11.10	PR: 1KE,1KP									
	1.8 TFSI	118	05.09	PR: 1KW,2EH	G2112178		300 12,0 10,0 +S +C					
	1.8 TFSI	125	10.07	PR: 1KW,2EH								
	2.0 TDI	105	09.09	PR: 1KW,2EH								
	2.0 TDI	110	05.13	PR: 1KW,2EH								
	2.0 TDI	120	10.08	PR: 1KW,2EH								
	2.0 TDI	125	08.08	PR: 1KW,2EH								
	2.0 TDI	130	07.11	PR: 1KW,2EH								
	2.0 TDI quattro	124	10.08	PR: 1KW,2EH								
	2.0 TDI quattro	125	08.08	PR: 1KW,2EH								
	2.0 TDI quattro	130	12.11	PR: 1KW,2EH								
	2.0 TFSI	132	11.08	PR: 1KW,2EH								
	2.0 TFSI	155	06.08	PR: 1KW,2EH								
	2.0 TFSI	165	05.13	PR: 1KW,2EH								
	2.0 TFSI quattro	155	06.08	PR: 1KW,2EH								
	2.0 TFSI quattro	165	05.13	PR: 1KW,2EH								
	2.7 TDI	120	09.07	PR: 1KW,2EH								
	2.7 TDI	140	05.07	PR: 1KW,2EH								
	3.0 TDI	150	07.11	PR: 1KW,2EH								
	3.0 TDI quattro	155	03.08	PR: 1KW,2EH								
	3.0 TDI quattro	176	05.07	PR: 1KW,2EH								
3.0 TDI quattro	180	07.11	PR: 1KW,2EH									
3.0 TFSI quattro	200	12.11	PR: 1KW,2EH									
3.2 FSI	195	05.07	PR: 1KW,2EH									
3.2 FSI quattro	195	06.07	PR: 1KW,2EH									

















**AUDI A5 Convertible (09-)**

	1.8 TFSI	118		09.09	PR: 1LT	G1020823		24705 19,8 +/Wl	ATE
	1.8 TFSI	125		07.11	PR: 1LT				
	2.0 TDI	105		11.11	PR: 1LT				
	2.0 TDI	110		05.13	PR: 1LT				
	2.0 TDI	120		05.09	PR: 1LT				
	2.0 TDI	125		05.09	PR: 1LT				
	2.0 TDI	130		07.11	PR: 1LT				
	2.0 TDI quattro	130		01.12	PR: 1LT				
	2.0 TFSI	132		03.09	PR: 1LT				
	2.0 TFSI	155		03.09	PR: 1LT				
	2.0 TFSI	165		05.13	PR: 1LT				
	2.0 TFSI quattro	155		03.09	PR: 1LT				
	2.0 TFSI quattro	165		05.13	PR: 1LT				
	2.7 TDI	120		05.09	PR: 1LT				
	2.7 TDI	140		03.09	PR: 1LT				
	3.0 TDI	150		07.11	PR: 1LT				
	3.0 TDI quattro	176		03.09	PR: 1LT				
	3.0 TDI quattro	180		07.11	PR: 1LT				
	3.0 TFSI quattro	200		11.11	PR: 1LT				
	3.2 FSI	195		03.09	PR: 1LT				
3.2 FSI quattro	195		03.09	PR: 1LT					
	1.8 TFSI	118		09.09	PR: 1LA,1LB,1LD	G1020983		24743 19,2 +/W/S	LUC
	1.8 TFSI	125		07.11	PR: 1LA,1LB,1LD				
	2.0 TDI	105		11.11	PR: 1LA,1LB,1LD,1LJ				
	2.0 TDI	110		05.13	PR: 1LA,1LB,1LD				
	2.0 TDI	120		05.09	PR: 1LA,1LB,1LD				
	2.0 TDI	125		05.09	PR: 1LA,1LB,1LD				
	2.0 TDI	130		07.11	PR: 1LA,1LB,1LD				
	2.0 TDI quattro	130		01.12	PR: 1LA,1LB,1LD,1LJ				
	2.0 TFSI	132		03.09	PR: 1LA,1LB,1LD				
	2.0 TFSI	155		03.09	PR: 1LA,1LB,1LD				
	2.0 TFSI	165		05.13	PR: 1LA,1LB,1LD				
	2.0 TFSI quattro	155		03.09	PR: 1LA,1LB,1LD				
	2.0 TFSI quattro	165		05.13	PR: 1LA,1LB,1LD				
	2.7 TDI	120		05.09	PR: 1LA,1LB,1LD				
	2.7 TDI	140		03.09	PR: 1LA,1LB,1LD				
	3.0 TDI	150		07.11	PR: 1LA,1LB,1LD				
	3.0 TDI quattro	176		03.09	PR: 1LA,1LB,1LD				
3.0 TDI quattro	180		07.11	PR: 1LA,1LB,1LD					
3.0 TFSI quattro	200		11.11	PR: 1LA,1LB,1LD,1LJ					
3.2 FSI	195		03.09	PR: 1LA,1LB,1LD					
3.2 FSI quattro	195		03.09	PR: 1LA,1LB,1LD					
S5	245		04.09	PR: 1ZT,1LD	G1020983		24743 19,2 +/W/S	LUC	
S5	245		07.11	PR: 1LJ	G1020983		24743 19,2 +/W/S	LUC	
	1.8 TFSI	118		09.09	PR: 1LT	G2125184		314 25,0 23,0 V L +S +C	
	1.8 TFSI	125		07.11	PR: 1LT				
	2.0 TDI	105		11.11	PR: 1LT				
	2.0 TDI	110		05.13	PR: 1LT				
	2.0 TDI	120		05.09	PR: 1LT				
	2.0 TDI	125		05.09	PR: 1LT				
	2.0 TDI	130		07.11	PR: 1LT				
	2.0 TDI quattro	130		01.12	PR: 1LT				
	2.0 TFSI	132		03.09	PR: 1LT				
	2.0 TFSI	155		03.09	PR: 1LT				
	2.0 TFSI	165		05.13	PR: 1LT				
	2.0 TFSI quattro	155		03.09	PR: 1LT				
	2.0 TFSI quattro	165		05.13	PR: 1LT				
	2.7 TDI	120		05.09	PR: 1LT				
	2.7 TDI	140		03.09	PR: 1LT				
	3.0 TDI	150		07.11	PR: 1LT				
	3.0 TDI quattro	176		03.09	PR: 1LT				
3.0 TDI quattro	180		07.11	PR: 1LT					
3.0 TFSI quattro	200		11.11	PR: 1LT					
3.2 FSI	195		03.09	PR: 1LT					
3.2 FSI quattro	195		03.09	PR: 1LT					
	1.8 TFSI	118		09.09	PR: 1KW,2EH	G1201004	electric parking brake <sup>1)</sup>	24606 17,4 +/Acc/S	LUC
	1.8 TFSI	125		07.11	PR: 1KW,2EH				
	2.0 TDI	105		11.11	PR: 1KW,2EH				
	2.0 TDI	110		05.13	PR: 1KW,2EH				
	2.0 TDI	120		05.09	PR: 1KW,2EH				
	2.0 TDI	125		05.09	PR: 1KW,2EH				
	2.0 TDI	130		07.11	PR: 1KW,2EH				
	2.0 TDI quattro	130		01.12	PR: 1KW,2EH				
	2.0 TFSI	132		03.09	PR: 1KW,2EH				
	2.0 TFSI	155		03.09	PR: 1KW,2EH				
	2.0 TFSI	165		05.13	PR: 1KW,2EH				
	2.0 TFSI quattro	155		03.09	PR: 1KW,2EH				
	2.0 TFSI quattro	165		05.13	PR: 1KW,2EH				
	2.7 TDI	120		05.09	PR: 1KW,2EH				
	2.7 TDI	140		03.09	PR: 1KW,2EH				
	3.0 TDI	150		07.11	PR: 1KW,2EH				
	3.0 TDI quattro	176		03.09	PR: 1KW,2EH				
3.0 TDI quattro	180		07.11	PR: 1KW,2EH					
3.0 TFSI quattro	200		11.11	PR: 1KW,2EH					
3.2 FSI	195		03.09	PR: 1KW,2EH					
3.2 FSI quattro	195		03.09	PR: 1KW,2EH					

<sup>1)</sup> fr.di stazionamento elettrico / frein à main électrique / freno de mano eléctrico / elektrische Feststellbremse

	   kW						
<b>AUDI A5 Convertible (09-)</b>							
	1.8 TFSI	118	09.09	PR: 1KE,1KP	G1201005	electric parking brake <sup>1)</sup>	24606 17,4 +/Acc/S LUC
	1.8 TFSI	125	07.11	PR: 1KE,1KP			
	2.0 TDI	105	11.11	PR: 1KE,1KP			
	2.0 TDI	110	05.13	PR: 1KE,1KP			
	2.0 TDI	120	05.09	PR: 1KE,1KP			
	2.0 TDI	125	05.09	PR: 1KE,1KP			
	2.0 TDI	130	07.11	PR: 1KE,1KP			
	2.0 TDI quattro	130	01.12	PR: 1KE,1KP			
	2.0 TFSI	132	03.09	PR: 1KE,1KP			
	2.0 TFSI	155	03.09	PR: 1KE,1KP			
	2.0 TFSI	165	05.13	PR: 1KE,1KP			
	2.0 TFSI quattro	155	03.09	PR: 1KE,1KP			
	2.0 TFSI quattro	165	05.13	PR: 1KE,1KP			
	2.7 TDI	120	05.09	PR: 1KE,1KP			
	2.7 TDI	140	03.09	PR: 1KE,1KP			
	3.0 TDI	150	07.11	PR: 1KE,1KP			
	3.0 TDI quattro	176	03.09	PR: 1KE,1KP			
3.0 TDI quattro	180	07.11	PR: 1KE,1KP				
3.0 TFSI quattro	200	11.11	PR: 1KE,1KP				
3.2 FSI	195	03.09	PR: 1KE,1KP				
3.2 FSI quattro	195	03.09	PR: 1KE,1KP				
S5	245	04.09	PR: 1KE,1KP				
<b>AUDI A6 / A6 Avant (4A/C4) (94-97)</b>							
	1.8		10.95	12.97	G2115105		288 15,0 13,0 L +C
	1.8 quattro		10.95	12.97			
	1.9 TDI		06.94	12.97			
	2.0		06.94	12.97			
	2.0 16V		06.94	12.97			
	2.0 quattro		06.94	12.97			
	2.3		06.94	12.95			
	2.3 quattro		08.94	12.95			
	2.5 TDI	85	06.94	12.97			
	2.5 TDI quattro	103	10.94	12.97			
2.5 TDI quattro		07.95	12.97	G2125105		288 25,0 23,0 V L +C	
2.6		06.94	12.97				
2.6 quattro		06.94	12.97				
2.8	128	06.94	12.97				
2.8	142	10.95	12.97				
2.8 quattro		06.94	12.97				
	1.8		10.95	12.97	G1020246		21144 15,8 /S LUC
	1.8 quattro		10.95	12.97			
	1.9 TDI		06.94	12.97			
	2.0		06.94	12.97			
	2.0 16V		06.94	12.97			
	2.0 quattro		06.94	12.97			
	2.3		06.94	12.95			
	2.3 quattro		08.94	12.95			
	2.5 TDI		06.94	12.97			
	2.5 TDI quattro		07.95	12.97			
	2.6		06.94	12.97			
	2.6 quattro		06.94	12.97			
	2.8	128	06.94	12.97			
2.8	142	10.95	12.97				
2.8 quattro		06.94	12.97				
S6 2.2	169	06.94	12.97				
S6 4.2	213	09.94	12.97				
S6 4.2 plus	235	06.96	12.97				
	1.8		10.95	12.97	G2110201		245 10,0 8,0 +C
	1.8 quattro		10.95	12.97			
	1.9 TDI		06.94	12.97			
	2.0		06.94	12.97			
	2.0 16V		06.94	12.97			
	2.0 quattro		06.94	12.97			
	2.3		06.94	12.95			
2.3 quattro		08.94	12.95				

<sup>1)</sup> fr. di stazionamento elettrico / frein à main électrique / freno de mano eléctrico / elektrische Feststellbremse



**AUDI A6 / A6 Avant (4A/C4) (94-97)**

	2.5 TDI		06.94	12.97	G2110201	245 10,0 8,0 +C
	2.5 TDI quattro		07.95	12.97		
	2.6		06.94	12.97		
	2.6 quattro		06.94	12.97		
	2.8	128	06.94	12.97		
	2.8 quattro	142	10.95	12.97		

**AUDI A6 / A6 Avant (4B/C5) (97-05)**

	1.8		04.97	01.05	G1020313	23018 20,3 +/Wl	ATE	
	1.8 T	110	04.97	01.05				
	1.8 T	132	12.97	01.05				
	1.8 T quattro		04.97	01.05				PR: 1LB,1LE,1LF,1LT
	1.9 TDI		04.97	01.05				
	2.0		08.01	01.05				
	2.4	100	07.98	01.05				
	2.4	115	04.97	01.05				
	2.4	121	04.97	01.05				
	2.4 quattro		04.97	01.05				PR: 1LB,1LE,1LF,1LT
	2.5 TDI	110	04.97	01.05				
	2.5 TDI	120	07.02	01.05				PR: 1LB,1LE,1LF,1LT
	2.5 TDI	132	02.00	01.05				PR: 1LB,1LE,1LF,1LT
	2.5 TDI quattro		07.97	01.05				PR: 1LB,1LE,1LF,1LT

	1.8 T quattro		06.01	01.05	G1020644	23762 20,3 +/Wl	ATE	
	2.4 quattro		06.01	01.05				PR: 1LG,1LA
	2.5 TDI	120	07.02	01.05				PR: 1LG,1LA
	2.5 TDI	132	02.00	01.05				PR: 1LG,1LA
	2.5 TDI quattro		06.01	01.05				PR: 1LG,1LA
	3.0		06.01	01.05				PR: 1LG,1LA
	3.0 quattro		06.01	01.05				PR: 1LG,1LA

	1.8		04.97	01.05	G2125105	288 25,0 23,0 V L +C	
	1.8 T	110	04.97	01.05			PR: 1LB,1LE
	1.8 T	132	12.97	01.05			PR: 1LB,1LE
	1.8 T quattro		04.97	01.05			PR: 1LB,1LE
	1.9 TDI		04.97	01.05			PR: 1LB,1LE
	2.0		08.01	01.05			PR: 1LB,1LE
	2.4	100	07.98	01.05			PR: 1LB,1LE
	2.4	115	04.97	01.05			PR: 1LB,1LE
	2.4	121	04.97	01.05			PR: 1LB,1LE
	2.4 quattro		04.97	01.05			PR: 1LB,1LE
	2.5 TDI	110	04.97	01.05			PR: 1LB,1LE
	2.5 TDI	120	07.02	01.05			PR: 1LB,1LE
	2.5 TDI	132	02.00	01.05			PR: 1LB,1LE
	2.5 TDI quattro		07.97	01.05			PR: 1LB,1LE

	1.8		04.97	01.05	G2125137	312 25,0 23,0 V L +C	
	1.8 T	110	04.97	01.05			PR: 1LF,1LT
	1.8 T	132	12.97	01.05			PR: 1LF,1LT
	1.8 T quattro		04.97	01.05			PR: 1LF,1LT
	1.9 TDI		04.97	01.05			PR: 1LF,1LT
	2.0		08.01	01.05			PR: 1LF,1LT
	2.4	100	07.98	01.05			PR: 1LF,1LT
	2.4	115	04.97	01.05			PR: 1LF,1LT
	2.4	121	04.97	01.05			PR: 1LF,1LT
	2.4 quattro		04.97	01.05			PR: 1LF,1LT
	2.5 TDI	110	04.97	01.05			PR: 1LF,1LT
	2.5 TDI	120	07.02	01.05			PR: 1LF,1LT
	2.5 TDI	132	02.00	01.05			PR: 1LF,1LT
	2.5 TDI quattro		07.97	01.05			PR: 1LF,1LT

	1.8 T	110	04.97	01.05	G2130113	320 30,0 28,0 V L +C	
	1.8 T quattro		06.01	01.05			PR: 1LG,1LA
	2.4 quattro		06.01	01.05			PR: 1LG,1LA
	2.5 TDI	110	04.97	01.05			PR: 1LG,1LA
	2.5 TDI	120	07.02	01.05			PR: 1LG,1LA
	2.5 TDI	132	02.00	01.05			PR: 1LG,1LA
	2.5 TDI quattro		06.01	01.05			PR: 1LG,1LA
	2.7 T		03.98	01.05			
	2.7 T quattro		10.97	01.05			
	3.0		06.01	01.05			
	3.0 quattro		06.01	01.05			

	1.8		04.97	05.01	G1020492	23554 17,1 /WD/S	LUC
	1.8 T	110	04.97	05.01			
	1.8 T	132	12.97	05.01			
	1.8 T quattro		04.97	05.01			
	1.9 TDI		04.97	05.01			
	2.4	100	07.98	05.01			
	2.4	115	04.97	05.01			
	2.4	121	04.97	05.01			
	2.4 quattro		04.97	05.01			
	2.5 TDI	110	04.97	05.01			
	2.5 TDI	132	02.00	05.01			
	2.5 TDI quattro		07.97	05.01			





### AUDI A6 / A6 Avant (4B/C5) (97-05)

	2.7 T 2.7 T quattro 2.8 2.8 quattro 4.2 quattro S6 4.2			03.98 10.97 04.97 04.97 11.98 09.99	05.01 05.01 05.01 05.01 05.01 05.01			G1020492		23554 17,1 /WD/S	LUC
	1.8 1.8 T 1.8 T 1.8 T quattro 1.9 TDI 2.0 2.4 2.4 2.4 2.4 quattro 2.5 TDI 2.5 TDI 2.5 TDI 2.5 TDI quattro 2.7 T 2.7 T quattro 2.8 2.8 quattro 3.0 3.0 quattro 4.2 quattro S6 4.2 RS 6 4.2			06.01 06.01 06.01 06.01 06.01 08.01 06.01 06.01 06.01 06.01 07.02 06.01 06.01 06.01 06.01 06.01 06.01 06.01 06.01 06.01 06.01 06.01 06.01 07.02	01.05 01.05			G1020676		20961 15,8 /S	LUC
	1.8 1.8 T 1.8 T 1.9 TDI 2.0 2.4 2.4 2.4 2.5 TDI 2.5 TDI 2.5 TDI 2.7 T 2.8 3.0			04.97 04.97 12.97 04.97 08.01 07.98 04.97 04.97 04.97 07.02 02.00 03.98 04.97 06.01	01.05 01.05 01.05 01.05 01.05 01.05 01.05 01.05 01.05 01.05 01.05 01.05 01.05 01.05			G2110201		245 10,0 8,0 +C	
	1.8 T Saloon Quattro 2.4 Saloon Quattro 2.5 TDI Saloon Quattro 2.7 T Saloon Quattro 2.8 Saloon Quattro 3.0 Saloon Quattro		4B-X-200000 4B-X-200000 4B-X-200000 4B-X-200000 4B-X-200000 4B-X-200000	04.97 04.97 07.97 10.97 04.97 06.01				G2110258		245 10,0 8,0 +C	
	1.8 T quattro 2.4 quattro 2.5 TDI quattro 2.7 T quattro 2.8 quattro 3.0 quattro	4B-Y-000001 4B-Y-000001 4B-Y-000001 4B-Y-000001 4B-Y-000001 4B-Y-000001		01.05 01.05 01.05 01.05 01.05 01.05	PR: ON1 PR: ON1 PR: ON1 PR: ON1 PR: ON1 PR: ON1			G2110258		245 10,0 8,0 +C	

### AUDI A6 Allroad (00-05)

	2.5 TDI 2.7 T 4.2			05.00 05.00 07.02	07.05 07.05 07.05	PR: 1LA PR: 1LA PR: 1LA		G1020644 G1020644		23762 20,3 +/Wl 23762 20,3 +/Wl	ATE
	2.5 TDI 2.7 T 4.2			05.00 05.00 07.02	07.05 07.05 07.05			G2130113		320 30,0 28,0 V L +C	
	2.5 TDI 2.7 T 4.2			05.00 05.00 07.02	07.05 07.05 07.05			G1020676		20961 15,8 /S	LUC

### AUDI A6 (4F2/C6) Saloon (04-11)

	2.0 TDI 2.0 TDI 2.0 TDI 2.0 TDI 2.0 TDI 2.0 TDI 2.0 TDI 2.0 TFSI 2.4 2.4 quattro 2.7 TDI 2.7 TDI 2.7 TDI quattro 2.7 TDI quattro 2.7 TDI quattro 2.8 FSI 2.8 FSI 2.8 FSI 2.8 FSI quattro	100 103 103 103 103 125 125 130 130 120 132 120 132 140 140 154 162 140		06.05 10.08 10.08 10.08 07.04 10.08 06.05 04.04 01.05 11.04 11.04 06.05 11.04 10.08 10.08 11.06 10.08 10.08	03.11 03.11 03.11 03.11 03.11 03.11 03.11 03.11 03.11 03.11 03.11 03.11 03.11 03.11 03.11 03.11 03.11 03.11 03.11	PR: 1LT PR: 1LT PR: 1LT PR: 1LT PR: 1LT PR: 1LT PR: 1LT PR: 1LT PR: 1LT PR: 1LT PR: 1LT PR: 1LT PR: 1LT PR: 1LT PR: 1LT PR: 1LT PR: 1LT PR: 1LT		G1020313		23018 20,3 +/Wl	ATE
--	--	--	--	--	---	--	--	----------	--	-----------------	-----





### AUDI A6 (4F2/C6) Saloon (04-11)

	2.8 FSI quattro	154	04.07	03.11	PR: 1LT	G1020313		23018 20,3 +/WI	ATE				
	2.8 FSI quattro	162	10.08	03.11	PR: 1LT								
	3.0	160	04.04	03.11	PR: 1LT								
	3.0 quattro	160	04.04	03.11	PR: 1LT								
	3.0 TDI quattro	155	04.04	03.11	PR: 1LT								
	3.0 TDI quattro	165	04.04	03.11	PR: 1LT								
	3.0 TDI quattro	171	06.06	03.11	PR: 1LT								
	3.2 FSI		04.04	03.11	PR: 1LT								
	3.2 FSI quattro	188	04.04	03.11	PR: 1LT								
	4.2 FSI quattro	257	06.06	03.11	PR: 1LT					G1020313		23018 20,3 +/WI	ATE
	4.2 quattro	246	04.04	03.11	PR: 1LT								
	2.0 TDI	100	06.05	03.11	PR: 1LG,1LD,1ZL,1LH					G1020754		23763 20,3 +/WI	ATE
	2.0 TDI	103	07.04	03.11	PR: 1LG,1LD,1ZL,1LH								
	2.0 TDI	125	10.08	03.11	PR: 1LG,1ZL								
	2.0 TFSI	125	06.05	03.11	PR: 1LG,1LD,1ZL,1LH								
	2.4	130	04.04	03.11	PR: 1LG,1LD,1ZL,1LH								
	2.4 quattro	130	01.05	03.11	PR: 1LG,1LD,1ZL,1LH								
2.7 TDI	120	11.04	03.11	PR: 1LG,1LD,1ZL,1LH									
2.7 TDI	132	11.04	03.11	PR: 1LG,1LD,1ZL,1LH									
2.7 TDI	140	10.08	03.11	PR: 1LG,1ZL									
2.7 TDI quattro	120	06.05	03.11	PR: 1LG,1LD,1ZL,1LH									
2.7 TDI quattro	132	11.04	03.11	PR: 1LG,1LD,1ZL,1LH									
2.7 TDI quattro	140	10.08	03.11	PR: 1LG,1ZL									
2.8 FSI	140	10.08	03.11	PR: 1LG,1ZL									
2.8 FSI	154	11.06	03.11	PR: 1LG,1LD,1ZL,1LH									
2.8 FSI	162	10.08	03.11	PR: 1LG,1ZL									
2.8 FSI quattro	140	10.08	03.11	PR: 1LG,1ZL									
2.8 FSI quattro	154	04.07	03.11	PR: 1LG,1LD,1ZL,1LH									
2.8 FSI quattro	162	10.08	03.11	PR: 1LG,1ZL									
3.0	160	04.04	03.11	PR: 1LG,1LD,1ZL,1LH									
3.0 quattro	160	04.04	03.11	PR: 1LG,1LD,1ZL,1LH									
3.0 TDI quattro	155	04.04	03.11	PR: 1LG,1LD,1ZL,1LH									
3.0 TDI quattro	165	04.04	03.11	PR: 1LG,1LD,1ZL,1LH									
3.0 TDI quattro	171	04.04	03.11	PR: 1LG,1LD,1ZL,1LH									
3.0 TDI quattro	176	10.08	03.11	PR: 1LG,1ZL									
3.0 TFSI quattro		10.08	03.11	PR: 1LG,1ZL									
3.2 FSI		04.04	03.11	PR: 1LG,1LD,1ZL,1LH									
3.2 FSI quattro	188	04.04	03.11	PR: 1LG,1LD,1ZL,1LH									
4.2 FSI quattro	257	06.06	03.11	PR: 1LG,1LD,1ZL,1LH	G1020754		23763 20,3 +/WI	ATE					
4.2 quattro	246	04.04	03.11	PR: 1LG,1LD,1ZL,1LH									
S6	320	03.06	03.11		G1020678		23896 20,6 +/WI	ATE					
	2.0 TDI	100	06.05	03.11	PR: 1LT	G2125149		314 25,0 23,0 V L + C					
	2.0 TDI	103	07.04	03.11	PR: 1LT								
	2.0 TDI	125	10.08	03.11	PR: 1LT								
	2.0 TFSI	125	06.05	03.11	PR: 1LT								
	2.4	130	04.04	03.11	PR: 1LT								
	2.4 quattro	130	01.05	03.11	PR: 1LT								
	2.7 TDI	120	11.04	03.11	PR: 1LT								
	2.7 TDI	132	11.04	03.11	PR: 1LT								
	2.7 TDI	140	10.08	03.11	PR: 1LT								
	2.7 TDI quattro	120	06.05	03.11	PR: 1LT								
	2.7 TDI quattro	132	11.04	03.11	PR: 1LT								
	2.7 TDI quattro	140	10.08	03.11	PR: 1LT								
	2.8 FSI	140	10.08	03.11	PR: 1LT								
	2.8 FSI	154	11.06	03.11	PR: 1LT								
	2.8 FSI	162	10.08	03.11	PR: 1LT								
	2.8 FSI quattro	140	10.08	03.11	PR: 1LT								
	2.8 FSI quattro	154	04.07	03.11	PR: 1LT								
	2.8 FSI quattro	162	10.08	03.11	PR: 1LT								
	3.0	160	04.04	03.11	PR: 1LT								
	3.0 quattro	160	04.04	03.11	PR: 1LT								
	3.0 TDI quattro	155	04.04	03.11	PR: 1LT								
	3.0 TDI quattro	165	04.04	03.11	PR: 1LT								
	3.0 TDI quattro	171	06.06	03.11	PR: 1LT								
	3.0 TDI quattro	176	10.08	03.11	PR: 1LT								
	3.0 TFSI quattro		10.08	03.11	PR: 1LT								
	3.2 FSI		04.04	03.11	PR: 1LT								
	3.2 FSI quattro	188	04.04	03.11	PR: 1LT								
	4.2 FSI quattro	257	06.06	03.11	PR: 1LT								
	4.2 quattro	246	04.04	03.11	PR: 1LT								
	2.0 TDI	100	06.05	03.11	PR: 1LG,1LD					G2130175		321 30,0 28,0 V L + S + C	
	2.0 TDI	103	07.04	03.11	PR: 1LG,1LD								
	2.0 TDI	125	10.08	03.11	PR: 1LG								
2.0 TFSI	125	06.05	03.11	PR: 1LG,1LD									
2.4	130	04.04	03.11	PR: 1LG,1LD									
2.4 quattro	130	01.05	03.11	PR: 1LG,1LD									
2.7 TDI	120	11.04	03.11	PR: 1LG,1LD									
2.7 TDI	132	11.04	03.11	PR: 1LG,1LD									
2.7 TDI	140	10.08	03.11	PR: 1LG									
2.7 TDI quattro	120	06.05	03.11	PR: 1LG,1LD									
2.7 TDI quattro	132	11.04	03.11	PR: 1LG,1LD									
2.7 TDI quattro	140	10.08	03.11	PR: 1LG									
2.8 FSI	140	10.08	03.11	PR: 1LG									
2.8 FSI	154	11.06	03.11	PR: 1LG,1LD									
2.8 FSI	162	10.08	03.11	PR: 1LG									
2.8 FSI quattro	140	10.08	03.11	PR: 1LG									
2.8 FSI quattro	154	04.07	03.11	PR: 1LG,1LD									



**AUDI A6 (4F2/C6) Saloon (04-11)**

	<p>2.8 FSI quattro 162 3.0 160 3.0 quattro 160 3.0 TDI quattro 155 3.0 TDI quattro 165 3.0 TDI quattro 171 3.0 TDI quattro 176 3.0 TFSI quattro 3.2 FSI 3.2 FSI quattro 188 4.2 FSI quattro 257 4.2 quattro 246</p>		<p>10.08 03.11 PR: 1LG 04.04 03.11 PR: 1LG,1LD 04.04 03.11 PR: 1LG,1LD 04.04 03.11 PR: 1LG,1LD 04.04 03.11 PR: 1LG,1LD 06.06 03.11 PR: 1LG,1LD 10.08 03.11 PR: 1LG 10.08 03.11 PR: 1LG 04.04 03.11 PR: 1LG,1LD 04.04 03.11 PR: 1LG,1LD 06.06 03.11 PR: 1LG,1LD 04.04 03.11 PR: 1LG,1LD</p>	<b>G2130175</b>		321 30,0 28,0 V L +S +C
	<p>2.0 TDI 100 2.0 TDI 103 2.0 TDI 125 2.0 TFSI 125 2.4 130 2.4 quattro 130 2.7 TDI 120 2.7 TDI 132 2.7 TDI 140 2.7 TDI quattro 120 2.7 TDI quattro 132 2.7 TDI quattro 140 2.8 FSI 140 2.8 FSI 154 2.8 FSI 162 2.8 FSI quattro 140 2.8 FSI quattro 154 2.8 FSI quattro 162 3.0 160 3.0 quattro 160 3.0 TDI quattro 155 3.0 TDI quattro 165 3.0 TDI quattro 171 3.0 TDI quattro 176 3.0 TFSI quattro 3.2 FSI 3.2 FSI quattro 188 4.2 FSI quattro 257 4.2 quattro 246</p>		<p>06.05 03.11 PR: 1ZL,1LH 07.04 03.11 PR: 1ZL,1LH 10.08 03.11 PR: 1ZL 06.05 03.11 PR: 1ZL,1LH 04.04 03.11 PR: 1ZL,1LH 01.05 03.11 PR: 1ZL,1LH 11.04 03.11 PR: 1ZL,1LH 11.04 03.11 PR: 1ZL,1LH 10.08 03.11 PR: 1ZL 06.05 03.11 PR: 1ZL,1LH 11.04 03.11 PR: 1ZL,1LH 10.08 03.11 PR: 1ZL 10.08 03.11 PR: 1ZL 11.06 03.11 PR: 1ZL,1LH 10.08 03.11 PR: 1ZL 10.08 03.11 PR: 1ZL 04.07 03.11 PR: 1ZL,1LH 10.08 03.11 PR: 1ZL 04.04 03.11 PR: 1ZL,1LH 04.04 03.11 PR: 1ZL,1LH 04.04 03.11 PR: 1ZL,1LH 04.04 03.11 PR: 1ZL,1LH 06.06 03.11 PR: 1ZL,1LH 10.08 03.11 PR: 1ZL 10.08 03.11 PR: 1ZL 04.04 03.11 PR: 1ZL,1LH 04.04 03.11 PR: 1ZL,1LH 06.06 03.11 PR: 1ZL,1LH 04.04 03.11 PR: 1ZL,1LH</p>	<b>G2130176</b>		347 30,0 28,0 V L +S +C
	<p>2.0 TDI 100 2.0 TDI 103 2.0 TDI 125 2.0 TFSI 125 2.4 130 2.4 quattro 130 2.7 TDI 120 2.7 TDI 132 2.7 TDI 140 2.7 TDI quattro 120 2.7 TDI quattro 132 2.7 TDI quattro 140 2.8 FSI 140 2.8 FSI 154 2.8 FSI 162 2.8 FSI quattro 140 2.8 FSI quattro 154 2.8 FSI quattro 162 3.0 160 3.0 quattro 160 3.0 TDI quattro 155 3.0 TDI quattro 165 3.0 TDI quattro 171 3.0 TDI quattro 176 3.0 TFSI quattro 3.2 FSI 3.2 FSI quattro 188 4.2 FSI quattro 257 4.2 quattro 246</p>		<p>06.05 03.11 PR: 1KD,2ED 07.04 03.11 PR: 1KD,2ED 10.08 03.11 PR: 1KD 06.05 03.11 PR: 1KD,2ED 04.04 03.11 PR: 1KD,2ED 01.05 03.11 PR: 1KD,2ED 11.04 03.11 PR: 1KD,2ED 11.04 03.11 PR: 1KD,2ED 10.08 03.11 PR: 1KD 06.05 03.11 PR: 1KD,2ED 11.04 03.11 PR: 1KD,2ED 10.08 03.11 PR: 1KD 10.08 03.11 PR: 1KD 11.06 03.11 PR: 1KD,2ED 10.08 03.11 PR: 1KD 10.08 03.11 PR: 1KD 04.07 03.11 PR: 1KD,2ED 10.08 03.11 PR: 1KD 04.04 03.11 PR: 1KD,2ED 04.04 03.11 PR: 1KD,2ED 04.04 03.11 PR: 1KD,2ED 04.04 03.11 PR: 1KD,2ED 06.06 03.11 PR: 1KD,2ED 10.08 03.11 PR: 1KD 10.08 03.11 PR: 1KD 04.04 03.11 PR: 1KD,2ED 04.04 03.11 PR: 1KD,2ED 06.06 03.11 PR: 1KD,2ED 04.04 03.11 PR: 1KD,2ED</p>	<b>G1020682</b>	electric parking brake <sup>1)</sup>	<b>23914</b> 17,1 /WD/Acc/S <b>LUC</b>
	<p>2.0 TDI 100 2.0 TDI 103 2.0 TDI 125 2.0 TFSI 125 2.4 130 2.4 quattro 130 2.7 TDI 120 2.7 TDI 132 2.7 TDI 140 2.7 TDI quattro 120 2.7 TDI quattro 132 2.7 TDI quattro 140 2.8 FSI 140 2.8 FSI 154 2.8 FSI 162 2.8 FSI quattro 140 2.8 FSI quattro 154 2.8 FSI quattro 162 3.0 160 3.0 quattro 160 3.0 TDI quattro 155 3.0 TDI quattro 165 3.0 TDI quattro 171 3.0 TDI quattro 176 3.0 TFSI quattro 3.2 FSI 3.2 FSI quattro 188 4.2 FSI quattro 257 4.2 quattro 246</p>		<p>06.05 03.11 PR: 1KW,2EE 07.04 03.11 PR: 1KW,2EE 10.08 03.11 PR: 1KW 06.05 03.11 PR: 1KW,2EE 04.04 03.11 PR: 1KW,2EE 01.05 03.11 PR: 1KW,2EE 11.04 03.11 PR: 1KW,2EE 11.04 03.11 PR: 1KW,2EE 10.08 03.11 PR: 1KW 06.05 03.11 PR: 1KW,2EE 11.04 03.11 PR: 1KW,2EE 10.08 03.11 PR: 1KW 10.08 03.11 PR: 1KW 11.06 03.11 PR: 1KW,2EE 10.08 03.11 PR: 1KW 10.08 03.11 PR: 1KW 04.07 03.11 PR: 1KW,2EE</p>	<b>G1020758</b>	electric parking brake <sup>1)</sup>	<b>23326</b> 17,4 /WD/S <b>LUC</b>

<sup>1)</sup> fr. di stazionamento elettrico / frein à main électrique / freno de mano eléctrico / elektrische Feststellbremse

















**AUDI A6 (4F2/C6) Saloon (04-11)**

	2.8 FSI quattro	162		10.08	03.11	PR: 1KW	<b>G1020758</b>	electric parking brake <sup>1)</sup>	23326 17,4 /WD/S	<b>LUC</b>				
	3.0	160		04.04	03.11	PR: 1KW,2EE								
	3.0 quattro	160		04.04	03.11	PR: 1KW,2EE								
	3.0 TDI quattro	155		04.04	03.11	PR: 1KW,2EE								
	3.0 TDI quattro	165		04.04	03.11	PR: 1KW,2EE								
	3.0 TDI quattro	171		06.06	03.11	PR: 1KW,2EE								
	3.0 TDI quattro	176		10.08	03.11	PR: 1KW								
	3.0 TFSI quattro			10.08	03.11	PR: 1KW								
	3.2 FSI			04.04	03.11	PR: 1KW,2EE								
	3.2 FSI quattro	188		04.04	03.11	PR: 1KW,2EE								
	4.2 FSI quattro	257		06.06	03.11	PR: 1KW,2EE								
	4.2 quattro	246		04.04	03.11	PR: 1KW,2EE								
	2.0 TDI	100		06.05	03.11	PR: 1KQ					<b>G1020993</b>	electric parking brake <sup>1)</sup>	24483 16,9 /Acc/S	<b>LUC</b>
	2.0 TDI	103		07.04	03.11	PR: 1KQ								
	2.0 TDI	125		10.08	03.11	PR: 1KQ								
	2.0 TFSI	125		06.05	03.11	PR: 1KQ								
	2.4	130		04.04	03.11	PR: 1KQ								
	2.4 quattro	130		01.05	03.11	PR: 1KQ								
2.7 TDI	120		11.04	03.11	PR: 1KQ									
2.7 TDI	132		11.04	03.11	PR: 1KQ									
2.7 TDI	140		10.08	03.11	PR: 1KQ									
2.7 TDI quattro	120		06.05	03.11	PR: 1KQ									
2.7 TDI quattro	132		11.04	03.11	PR: 1KQ									
2.7 TDI quattro	140		10.08	03.11	PR: 1KQ									
2.8 FSI	140		10.08	03.11	PR: 1KQ									
2.8 FSI	154		11.06	03.11	PR: 1KQ									
2.8 FSI	162		10.08	03.11	PR: 1KQ									
2.8 FSI quattro	140		10.08	03.11	PR: 1KQ									
2.8 FSI quattro	154		04.07	03.11	PR: 1KQ									
2.8 FSI quattro	162		10.08	03.11	PR: 1KQ									
3.0	160		04.04	03.11	PR: 1KQ									
3.0 quattro	160		04.04	03.11	PR: 1KQ									
3.0 TDI quattro	155		04.04	03.11	PR: 1KQ									
3.0 TDI quattro	165		04.04	03.11	PR: 1KQ									
3.0 TDI quattro	171		06.06	03.11	PR: 1KQ									
3.0 TDI quattro	176		10.08	03.11	PR: 1KQ									
3.0 TFSI quattro			10.08	03.11	PR: 1KQ									
3.2 FSI			04.04	03.11	PR: 1KQ									
3.2 FSI quattro	188		04.04	03.11	PR: 1KQ									
4.2 FSI quattro	257		06.06	03.11	PR: 1KQ									
4.2 quattro	246		04.04	03.11	PR: 1KQ									
RS 6	426		04.08	03.11		<b>G1020758</b>	electric parking brake <sup>1)</sup>	23326 17,4 /WD/S	<b>LUC</b>					
S6	320		03.06	03.11	PR: 1KW,2EE									

**AUDI A6 (4F5/C6) Avant (05-11)**

	2.0 TDI	100		06.05	08.11	PR: 1LT	<b>G1020313</b>		23018 20,3 +/-WI	<b>ATE</b>
	2.0 TDI	103		03.05	08.11	PR: 1LT				
	2.0 TDI	125		10.08	08.11	PR: 1LT				
	2.0 TFSI	125		06.05	08.11	PR: 1LT				
	2.4	130		03.05	08.11	PR: 1LT				
	2.4 quattro	130		03.05	08.11	PR: 1LT				
	2.7 TDI	120		03.05	08.11	PR: 1LT				
	2.7 TDI	132		03.05	08.11	PR: 1LT				
	2.7 TDI	140		10.08	08.11	PR: 1LT				
	2.7 TDI quattro	120		06.05	08.11	PR: 1LT				
	2.7 TDI quattro	132		03.05	08.11	PR: 1LT				
	2.7 TDI quattro	140		10.08	08.11	PR: 1LT				
	2.8 FSI	140		10.08	08.11	PR: 1LT				
	2.8 FSI	154		11.06	08.11	PR: 1LT				
	2.8 FSI	162		10.08	08.11	PR: 1LT				
	2.8 FSI quattro	140		10.08	08.11	PR: 1LT				
	2.8 FSI quattro	154		04.07	08.11	PR: 1LT				
	2.8 FSI quattro	162		10.08	08.11	PR: 1LT				
	3.0	160		03.05	08.11	PR: 1LT				
	3.0 quattro	160		03.05	08.11	PR: 1LT				
	3.0 TDI quattro	155		03.05	08.11	PR: 1LT				
	3.0 TDI quattro	165		03.05	08.11	PR: 1LT				
	3.0 TDI quattro	171		06.06	08.11	PR: 1LT				
	3.0 TDI quattro	176		10.08	08.11	PR: 1LT				
	3.0 TFSI quattro			10.08	08.11	PR: 1LT				
	3.2 FSI	188		03.05	08.11	PR: 1LT				
3.2 FSI quattro	188		03.05	08.11	PR: 1LT					
4.2 FSI quattro	257		06.06	08.11	PR: 1LT	<b>G1020313</b>		23018 20,3 +/-WI	<b>ATE</b>	
4.2 quattro	246		03.05	08.11	PR: 1LT					
2.0 TDI	100		06.05	08.11	PR: 1LG,1LD,1ZL,1LH	<b>G1020754</b>		23763 20,3 +/-WI	<b>ATE</b>	
2.0 TDI	103		03.05	08.11	PR: 1LG,1LD,1ZL,1LH					
2.0 TDI	125		10.08	08.11	PR: 1LG,1ZL					
2.0 TFSI	125		06.05	08.11	PR: 1LG,1LD,1ZL,1LH					
2.4	130		03.05	08.11	PR: 1LG,1LD,1ZL,1LH					
2.4 quattro	130		03.05	08.11	PR: 1LG,1LD,1ZL,1LH					
2.7 TDI	120		03.05	08.11	PR: 1LG,1LD,1ZL,1LH					
2.7 TDI	132		03.05	08.11	PR: 1LG,1LD,1ZL,1LH					
2.7 TDI	140		10.08	08.11	PR: 1LG,1ZL					
2.7 TDI quattro	120		06.05	08.11	PR: 1LG,1LD,1ZL,1LH					
2.7 TDI quattro	132		03.05	08.11	PR: 1LG,1LD,1ZL,1LH					
2.7 TDI quattro	140		10.08	08.11	PR: 1LG,1ZL					
2.8 FSI	140		10.08	08.11	PR: 1LG,1ZL					

<sup>1)</sup> fr. di stazionamento elettrico / frein à main électrique / freno de mano eléctrico / elektrische Feststellbremse

										
<b>AUDI A6 (4F5/C6) Avant (05-11)</b>										
	2.8 FSI	154		11.06	08.11	PR: 1LG,1LD,1ZL,1LH	<b>G1020754</b>		<b>23763 20,3 +/WI</b>	<b>ATE</b>
	2.8 FSI	162		10.08	08.11	PR: 1LG,1ZL				
	2.8 FSI quattro	140		10.08	08.11	PR: 1LG,1ZL				
	2.8 FSI quattro	154		04.07	08.11	PR: 1LG,1LD,1ZL,1LH				
	2.8 FSI quattro	162		10.08	08.11	PR: 1LG,1ZL				
	3.0	160		03.05	08.11	PR: 1LG,1LD,1ZL,1LH				
	3.0 quattro	160		03.05	08.11	PR: 1LG,1LD,1ZL,1LH				
	3.0 TDI quattro	155		03.05	08.11	PR: 1LG,1LD,1ZL,1LH				
	3.0 TDI quattro	165		03.05	08.11	PR: 1LG,1LD,1ZL,1LH				
	3.0 TDI quattro	171		06.06	08.11	PR: 1LG,1LD,1ZL,1LH				
	3.0 TDI quattro	176		10.08	08.11	PR: 1LG,1ZL				
3.0 TFSI quattro			10.08	08.11	PR: 1LG,1ZL					
3.2 FSI	188		03.05	08.11	PR: 1LG,1LD,1ZL,1LH					
3.2 FSI quattro	188		03.05	08.11	PR: 1LG,1LD,1ZL,1LH					
4.2 FSI quattro	257		06.06	08.11	PR: 1LG,1LD,1ZL,1LH	<b>G1020754</b>		<b>23763 20,3 +/WI</b>	<b>ATE</b>	
4.2 quattro	246		03.05	08.11	PR: 1LG,1LD,1ZL,1LH					
S6	320		03.06	08.11		<b>G1020678</b>		<b>23896 20,6 +/WI</b>	<b>ATE</b>	
	2.0 TDI	100		06.05	08.11	PR: 1LT	<b>G2125149</b>		<b>314 25,0 23,0 V L +C</b>	
	2.0 TDI	103		03.05	08.11	PR: 1LT				
	2.0 TDI	125		10.08	08.11	PR: 1LT				
	2.0 TFSI	125		06.05	08.11	PR: 1LT				
	2.4	130		03.05	08.11	PR: 1LT				
	2.4 quattro	130		03.05	08.11	PR: 1LT				
	2.7 TDI	120		03.05	08.11	PR: 1LT				
	2.7 TDI	132		03.05	08.11	PR: 1LT				
	2.7 TDI	140		10.08	08.11	PR: 1LT				
	2.7 TDI quattro	120		06.05	08.11	PR: 1LT				
	2.7 TDI quattro	132		03.05	08.11	PR: 1LT				
	2.7 TDI quattro	140		10.08	08.11	PR: 1LT				
	2.8 FSI	140		10.08	08.11	PR: 1LT				
	2.8 FSI	154		11.06	08.11	PR: 1LT				
	2.8 FSI	162		10.08	08.11	PR: 1LT				
	2.8 FSI quattro	140		10.08	08.11	PR: 1LT				
	2.8 FSI quattro	154		04.07	08.11	PR: 1LT				
	2.8 FSI quattro	162		10.08	08.11	PR: 1LT				
	3.0	160		03.05	08.11	PR: 1LT				
	3.0 quattro	160		03.05	08.11	PR: 1LT				
	3.0 TDI quattro	155		03.05	08.11	PR: 1LT				
	3.0 TDI quattro	165		03.05	08.11	PR: 1LT				
	3.0 TDI quattro	171		06.06	08.11	PR: 1LT				
	3.0 TDI quattro	176		10.08	08.11	PR: 1LT				
	3.0 TFSI quattro			10.08	08.11	PR: 1LT				
	3.2 FSI	188		03.05	08.11	PR: 1LT				
	3.2 FSI quattro	188		03.05	08.11	PR: 1LT				
	4.2 FSI quattro	257		06.06	08.11	PR: 1LT				
	4.2 quattro	246		03.05	08.11	PR: 1LT				
	2.0 TDI	100		06.05	08.11	PR: 1LG,1LD				
2.0 TDI	103		03.05	08.11	PR: 1LG,1LD					
2.0 TDI	125		10.08	08.11	PR: 1LG					
2.0 TFSI	125		06.05	08.11	PR: 1LG,1LD					
2.4	130		03.05	08.11	PR: 1LG,1LD					
2.4 quattro	130		03.05	08.11	PR: 1LG,1LD					
2.7 TDI	120		03.05	08.11	PR: 1LG,1LD					
2.7 TDI	132		03.05	08.11	PR: 1LG,1LD					
2.7 TDI	140		10.08	08.11	PR: 1LG					
2.7 TDI quattro	120		06.05	08.11	PR: 1LG,1LD					
2.7 TDI quattro	132		03.05	08.11	PR: 1LG,1LD					
2.7 TDI quattro	140		10.08	08.11	PR: 1LG					
2.8 FSI	140		10.08	08.11	PR: 1LG					
2.8 FSI	154		11.06	08.11	PR: 1LG,1LD					
2.8 FSI	162		10.08	08.11	PR: 1LG					
2.8 FSI quattro	140		10.08	08.11	PR: 1LG					
2.8 FSI quattro	154		04.07	08.11	PR: 1LG,1LD					
2.8 FSI quattro	162		10.08	08.11	PR: 1LG					
3.0	160		03.05	08.11	PR: 1LG,1LD					
3.0 quattro	160		03.05	08.11	PR: 1LG,1LD					
3.0 TDI quattro	155		03.05	08.11	PR: 1LG,1LD					
3.0 TDI quattro	165		03.05	08.11	PR: 1LG,1LD					
3.0 TDI quattro	171		06.06	08.11	PR: 1LG,1LD					
3.0 TDI quattro	176		10.08	08.11	PR: 1LG					
3.0 TFSI quattro			10.08	08.11	PR: 1LG					
3.2 FSI	188		03.05	08.11	PR: 1LG,1LD					
3.2 FSI quattro	188		03.05	08.11	PR: 1LG,1LD					
4.2 FSI quattro	257		06.06	08.11	PR: 1LG,1LD					
4.2 quattro	246		03.05	08.11	PR: 1LG,1LD					
2.0 TDI	100		06.05	08.11	PR: 1ZL,1LH	<b>G2130176</b>		<b>347 30,0 28,0 V L +S +C</b>		
2.0 TDI	103		03.05	08.11	PR: 1ZL,1LH					
2.0 TDI	125		10.08	08.11	PR: 1ZL					
2.0 TFSI	125		06.05	08.11	PR: 1ZL,1LH					
2.4	130		03.05	08.11	PR: 1ZL,1LH					
2.4 quattro	130		03.05	08.11	PR: 1ZL,1LH					
2.7 TDI	120		03.05	08.11	PR: 1ZL,1LH					
2.7 TDI	132		03.05	08.11	PR: 1ZL,1LH					
2.7 TDI	140		10.08	08.11	PR: 1ZL					
2.7 TDI quattro	120		06.05	08.11	PR: 1ZL,1LH					
2.7 TDI quattro	132		03.05	08.11	PR: 1ZL,1LH					
2.7 TDI quattro	140		10.08	08.11	PR: 1ZL					



**AUDI A6 (4F5/C6) Avant (05-11)**

	2.8 FSI	140		10.08	08.11	PR: 1ZL	<b>G2130176</b>		347 30,0 28,0 VL +S +C	
	2.8 FSI	154		11.06	08.11	PR: 1ZL,1LH				
	2.8 FSI	162		10.08	08.11	PR: 1ZL				
	2.8 FSI quattro	140		10.08	08.11	PR: 1ZL				
	2.8 FSI quattro	154		04.07	08.11	PR: 1ZL,1LH				
	2.8 FSI quattro	162		10.08	08.11	PR: 1ZL				
	3.0	160		03.05	08.11	PR: 1ZL,1LH				
	3.0 quattro	160		03.05	08.11	PR: 1ZL,1LH				
	3.0 TDI quattro	155		03.05	08.11	PR: 1ZL,1LH				
	3.0 TDI quattro	165		03.05	08.11	PR: 1ZL,1LH				
	3.0 TDI quattro	171		06.06	08.11	PR: 1ZL,1LH				
	3.0 TDI quattro	176		10.08	08.11	PR: 1ZL				
	3.0 TFSI quattro			10.08	08.11	PR: 1ZL				
	3.2 FSI	188		03.05	08.11	PR: 1ZL,1LH				
	3.2 FSI quattro	188		03.05	08.11	PR: 1ZL,1LH				
	4.2 FSI quattro	257		06.06	08.11	PR: 1ZL,1LH				
	4.2 quattro	246		03.05	08.11	PR: 1ZL,1LH				
	2.0 TDI	100		06.05	08.11	PR: 1KD,2ED	<b>G1020682</b>	electric parking brake <sup>1)</sup>	23914 17,1 /WD/Acc/S	<b>LUC</b>
	2.0 TDI	103		03.05	08.11	PR: 1KD,2ED				
	2.0 TDI	125		10.08	08.11	PR: 1KD				
	2.0 TFSI	125		06.05	08.11	PR: 1KD,2ED				
	2.4	130		03.05	08.11	PR: 1KD,2ED				
	2.4 quattro	130		03.05	08.11	PR: 1KD,2ED				
	2.7 TDI	120		03.05	08.11	PR: 1KD,2ED				
	2.7 TDI	132		03.05	08.11	PR: 1KD,2ED				
	2.7 TDI	140		10.08	08.11	PR: 1KD				
	2.7 TDI quattro	120		06.05	08.11	PR: 1KD,2ED				
	2.7 TDI quattro	132		03.05	08.11	PR: 1KD,2ED				
	2.7 TDI quattro	140		10.08	08.11	PR: 1KD				
	2.8 FSI	140		10.08	08.11	PR: 1KD				
	2.8 FSI	154		11.06	08.11	PR: 1KD,2ED				
	2.8 FSI	162		10.08	08.11	PR: 1KD				
	2.8 FSI quattro	140		10.08	08.11	PR: 1KD				
	2.8 FSI quattro	154		04.07	08.11	PR: 1KD,2ED				
	2.8 FSI quattro	162		10.08	08.11	PR: 1KD				
	3.0	160		03.05	08.11	PR: 1KD,2ED				
	3.0 quattro	160		03.05	08.11	PR: 1KD,2ED				
	3.0 TDI quattro	155		03.05	08.11	PR: 1KD,2ED				
	3.0 TDI quattro	165		03.05	08.11	PR: 1KD,2ED				
	3.0 TDI quattro	171		06.06	08.11	PR: 1KD,2ED				
	3.0 TDI quattro	176		10.08	08.11	PR: 1KD				
	3.0 TFSI quattro			10.08	08.11	PR: 1KD				
	3.2 FSI	188		03.05	08.11	PR: 1KD,2ED				
	3.2 FSI quattro	188		03.05	08.11	PR: 1KD,2ED				
	4.2 FSI quattro	257		06.06	08.11	PR: 1KD,2ED				
	4.2 quattro	246		03.05	08.11	PR: 1KD,2ED				
		2.0 TDI	100		06.05	08.11				
2.0 TDI		103		03.05	08.11	PR: 1KW,2EE				
2.0 TDI		125		10.08	08.11	PR: 1KW				
2.0 TFSI		125		06.05	08.11	PR: 1KW,2EE				
2.4		130		03.05	08.11	PR: 1KW,2EE				
2.4 quattro		130		03.05	08.11	PR: 1KW,2EE				
2.7 TDI		120		03.05	08.11	PR: 1KW,2EE				
2.7 TDI		132		03.05	08.11	PR: 1KW,2EE				
2.7 TDI		140		10.08	08.11	PR: 1KW				
2.7 TDI quattro		120		06.05	08.11	PR: 1KW,2EE				
2.7 TDI quattro		132		03.05	08.11	PR: 1KW,2EE				
2.7 TDI quattro		140		10.08	08.11	PR: 1KW				
2.8 FSI		140		10.08	08.11	PR: 1KW				
2.8 FSI		154		11.06	08.11	PR: 1KW,2EE				
2.8 FSI		162		10.08	08.11	PR: 1KW				
2.8 FSI quattro		140		10.08	08.11	PR: 1KW				
2.8 FSI quattro		154		04.07	08.11	PR: 1KW,2EE				
2.8 FSI quattro		162		10.08	08.11	PR: 1KW				
3.0		160		03.05	08.11	PR: 1KW,2EE				
3.0 quattro		160		03.05	08.11	PR: 1KW,2EE				
3.0 TDI quattro		155		03.05	08.11	PR: 1KW,2EE				
3.0 TDI quattro		165		03.05	08.11	PR: 1KW,2EE				
3.0 TDI quattro		171		06.06	08.11	PR: 1KW,2EE				
3.0 TDI quattro		176		10.08	08.11	PR: 1KW				
3.0 TFSI quattro				10.08	08.11	PR: 1KW				
3.2 FSI		188		03.05	08.11	PR: 1KW,2EE				
3.2 FSI quattro		188		03.05	08.11	PR: 1KW,2EE				
4.2 FSI quattro		257		06.06	08.11	PR: 1KW,2EE				
4.2 quattro		246		03.05	08.11	PR: 1KW,2EE				
		2.0 TDI	100		06.05	08.11	PR: 1KQ	<b>G1020993</b>	electric parking brake <sup>1)</sup>	24483 16,9 /Acc/S
	2.0 TDI	103		03.05	08.11	PR: 1KQ				
	2.0 TDI	125		10.08	08.11	PR: 1KQ				
	2.0 TFSI	125		06.05	08.11	PR: 1KQ				
	2.4	130		03.05	08.11	PR: 1KQ				
	2.4 quattro	130		03.05	08.11	PR: 1KQ				
	2.7 TDI	120		03.05	08.11	PR: 1KQ				
	2.7 TDI	132		03.05	08.11	PR: 1KQ				
	2.7 TDI	140		10.08	08.11	PR: 1KQ				
	2.7 TDI quattro	120		06.05	08.11	PR: 1KQ				
	2.7 TDI quattro	132		03.05	08.11	PR: 1KQ				
	2.7 TDI quattro	140		10.08	08.11	PR: 1KQ				

<sup>1)</sup> fr. di stazionamento elettrico / frein à main électrique / freno de mano eléctrico / elektrisches Feststellbremse

<b>AUDI A6 (4F5/C6) Avant (05-11)</b>																	
	2.8 FSI	140		10.08	08.11	PR: 1KQ		G1020993		electric parking brake <sup>1)</sup>	24483 16,9 /Acc/S	LUC					
	2.8 FSI	154		11.06	08.11	PR: 1KQ											
	2.8 FSI	162		10.08	08.11	PR: 1KQ											
	2.8 FSI quattro	140		10.08	08.11	PR: 1KQ											
	2.8 FSI quattro	154		04.07	08.11	PR: 1KQ											
	2.8 FSI quattro	162		10.08	08.11	PR: 1KQ											
	3.0	160		03.05	08.11	PR: 1KQ											
	3.0 quattro	160		03.05	08.11	PR: 1KQ											
	3.0 TDI quattro	155		03.05	08.11	PR: 1KQ											
	3.0 TDI quattro	165		03.05	08.11	PR: 1KQ											
	3.0 TDI quattro	171		06.06	08.11	PR: 1KQ											
	3.0 TDI quattro	176		10.08	08.11	PR: 1KQ											
	3.0 TFSI quattro			10.08	08.11	PR: 1KQ											
	3.2 FSI	188		03.05	08.11	PR: 1KQ											
3.2 FSI quattro	188		03.05	08.11	PR: 1KQ												
4.2 FSI quattro	257		06.06	08.11	PR: 1KQ												
4.2 quattro	246		03.05	08.11	PR: 1KQ												
RS 6	426		04.08	08.11			G1020758		electric parking brake <sup>1)</sup>	23326 17,4 /WD/S	LUC						
S6	320		03.06	08.11	PR: 1KW,2EE												
<b>AUDI A6 Allroad (06-11)</b>																	
	2.7 TDI	120		05.06	05.11	PR: 1LG,1ZL		G1020754			23763 20,3 +/WI	ATE					
	2.7 TDI	132		05.06	05.11	PR: 1LG,1ZL											
	2.7 TDI	140		10.08	05.11	PR: 1LG,1ZL											
	3.0 TDI	155		05.06	05.11	PR: 1LG,1ZL											
	3.0 TDI	171		05.06	05.11	PR: 1LG,1ZL											
	3.0 TDI	176		10.08	05.11	PR: 1LG,1ZL											
	3.0 TFSI	213		10.08	05.11	PR: 1LG,1ZL											
	3.2 FSI	188		05.06	05.11	PR: 1LG,1ZL											
4.2 FSI	257		05.06	05.11	PR: 1LG,1ZL		G1020754			23763 20,3 +/WI	ATE						
	2.7 TDI	120		05.06	05.11	PR: 1LG		G2130175			321 30,0 28,0 V L +S +C						
	2.7 TDI	132		05.06	05.11	PR: 1LG											
	2.7 TDI	140		10.08	05.11	PR: 1LG											
	3.0 TDI	155		05.06	05.11	PR: 1LG											
	3.0 TDI	171		05.06	05.11	PR: 1LG											
	3.0 TDI	176		10.08	05.11	PR: 1LG											
	3.0 TFSI	213		10.08	05.11	PR: 1LG											
	3.2 FSI	188		05.06	05.11	PR: 1LG											
	4.2 FSI	257		05.06	05.11	PR: 1LG											
	2.7 TDI	120		05.06	05.11	PR: 1ZL							G2130176			347 30,0 28,0 V L +S +C	
	2.7 TDI	132		05.06	05.11	PR: 1ZL											
	2.7 TDI	140		10.08	05.11	PR: 1ZL											
3.0 TDI	155		05.06	05.11	PR: 1ZL												
3.0 TDI	171		05.06	05.11	PR: 1ZL												
3.0 TDI	176		10.08	05.11	PR: 1ZL												
3.0 TFSI	213		10.08	05.11	PR: 1ZL												
3.2 FSI	188		05.06	05.11	PR: 1ZL												
4.2 FSI	257		05.06	05.11	PR: 1ZL												
	2.7 TDI	120		05.06	05.11	PR: 1KD		G1020682		electric parking brake <sup>1)</sup>	23914 17,1 /WD/Acc/S	LUC					
	2.7 TDI	132		05.06	05.11	PR: 1KD											
	2.7 TDI	140		10.08	05.11	PR: 1KD											
	3.0 TDI	155		05.06	05.11	PR: 1KD											
	3.0 TDI	171		05.06	05.11	PR: 1KD											
	3.0 TDI	176		10.08	05.11	PR: 1KD											
	3.0 TFSI	213		10.08	05.11	PR: 1KD											
	3.2 FSI	188		05.06	05.11	PR: 1KD											
	4.2 FSI	257		05.06	05.11	PR: 1KD											
	2.7 TDI	120		05.06	05.11	PR: 1KW,2EE							G1020758		electric parking brake <sup>1)</sup>	23326 17,4 /WD/S	LUC
2.7 TDI	132		05.06	05.11	PR: 1KW,2EE												
2.7 TDI	140		10.08	05.11	PR: 1KW,2EE												
3.0 TDI	155		05.06	05.11	PR: 1KW,2EE												
3.0 TDI	171		05.06	05.11	PR: 1KW,2EE												
3.0 TDI	176		10.08	05.11	PR: 1KW,2EE												
3.0 TFSI	213		10.08	05.11	PR: 1KW,2EE												
3.2 FSI	188		05.06	05.11	PR: 1KW,2EE												
4.2 FSI	257		05.06	05.11	PR: 1KW,2EE												
<b>AUDI A6 (4G2/C7) Saloon (11-)</b>																	
	2.0 TDI	120		04.11		PR: 1KW		G2112178			300 12,0 10,0 +S +C						
	2.0 TDI	130		04.11		PR: 1KW											
	2.0 TFSI	132		04.11		PR: 1KW											
	2.0 TFSI	155		04.11		PR: 1KW											
	2.0 TFSI	162		05.13		PR: 1KW											
	2.0 TFSI hybrid	155		11.11		PR: 1KW											
	2.0 TFSI quattro	155		05.12		PR: 1KW											
	2.0 TFSI quattro	162		05.13		PR: 1KW											
	2.8 FSI	150		04.11		PR: 1KW											
	2.8 FSI quattro	150		04.11		PR: 1KW											
	3.0 TDI	150		04.11		PR: 1KW											
	3.0 TDI quattro	150		04.11		PR: 1KW											
	3.0 TDI quattro	176		05.13		PR: 1KW											
	3.0 TDI quattro	180		04.11		PR: 1KW											
	3.0 TDI quattro	230		12.11		PR: 1KW											
	3.0 TFSI quattro			04.11		PR: 1KW											
S6	309		04.12		PR: 1KW												

<sup>1)</sup> fr.di stazionamento elettrico / frein à main électrique / freno de mano eléctrico / elektrische Feststellbremse



AUDI A6 (4G5/C7) Avant (11-)											
	2.0 TDI	120		09.11		PR: 1KW	G2112178		300 12,0 10,0 +S +C		
	2.0 TDI	130		09.11		PR: 1KW					
	2.0 TFSI	132		06.11		PR: 1KW					
	2.8 FSI	150		09.11		PR: 1KW					
	2.8 FSI quattro	150		09.11		PR: 1KW					
	3.0 TDI	150		09.11		PR: 1KW					
	3.0 TDI quattro	150		09.11		PR: 1KW					
	3.0 TDI quattro	180		09.11		PR: 1KW					
	3.0 TDI quattro	230		12.11		PR: 1KW					
	3.0 TFSI quattro			09.11		PR: 1KW					
S6	309		04.12		PR: 1KW						
AUDI A7 Sportback (10-)											
	2.8 FSI	150		05.11		PR: 1KW	G2112178	electric parking brake <sup>1)</sup>	300 12,0 10,0 +S +C		
	2.8 FSI quattro	150		07.10		PR: 1KW					
	3.0 TDI	150		11.10		PR: 1KW					
	3.0 TDI quattro	150		07.10		PR: 1KW					
	3.0 TDI quattro	176		05.13		PR: 1KW					
	3.0 TDI quattro	180		07.10		PR: 1KW					
	3.0 TDI quattro	230		11.11		PR: 1KW					
	3.0 TDI quattro			07.10		PR: 1KW					
	3.0 TFSI quattro			07.10		PR: 1KW					
	S7	309		10.11		PR: 1KW					
AUDI A8 (94-02)											
	6.0 W12 quattro			01.01	09.02		G1020683		21484 20,5 +/WD	ATE	
	2.5 TDI			06.97	09.98						
	2.5 TDI quattro			06.97	09.98						
	2.8	120		07.95	03.96						
	2.8	128		06.94	03.96						
	2.8 30V	142		04.96	09.98						
	2.8 30V quattro	142		04.96	09.98						
	2.8 quattro	120		07.95	03.96						
	2.8 quattro	128		06.94	03.96						
	3.7			07.95	09.98						
3.7 quattro			10.95	09.98							
4.2 quattro			06.94	09.98							
S8 4.2			06.96	09.98							
2.5 TDI			10.98	09.02	- special vehicles <sup>2)</sup>	G1020492		23554 17,1 /WD/S	LUC		
2.5 TDI quattro			10.98	09.02	- special vehicles <sup>2)</sup>						
2.8 30V	142		10.98	09.02	- special vehicles <sup>2)</sup>						
2.8 30V quattro	142		10.98	09.02	- special vehicles <sup>2)</sup>						
3.3 TDI quattro			12.99	09.02	- special vehicles <sup>2)</sup>						
3.7			10.98	09.02	- special vehicles <sup>2)</sup>						
3.7 quattro			10.98	09.02	- special vehicles <sup>2)</sup>						
4.2 quattro			10.98	09.02	- special vehicles <sup>2)</sup>						
6.0 W12 quattro			01.01	09.02	- special vehicles <sup>2)</sup>						
S8 4.2			10.98	09.02	- special vehicles <sup>2)</sup>						
6.0 W12 quattro			01.01	09.02	- special vehicles <sup>2)</sup>	G2122152		280 22,0 20,0 V L +C			
S8 4.2			10.98	09.02	- special vehicles <sup>2)</sup>						
AUDI A8 (03-09)											
	2.8 FSI	154		08.07	10.09	PR: 1LG	G1020754		23763 20,3 +/WI	ATE	
	3.0			07.03	10.09	PR: 1LG					
	3.0 TDI quattro			11.03	10.09	PR: 1LG					
	3.2 FSI	191		06.05	10.09	PR: 1LG					
	3.2 FSI quattro	191		06.05	10.09	PR: 1LG					
	3.7 quattro			11.02	10.09	PR: 1LG					
	4.0 TDI quattro			03.03	10.09	PR: 1LG					
	4.2 FSI quattro	257		06.06	10.09	PR: 1LG					
	4.2 quattro			11.02	10.09	PR: 1LG					
	4.2 TDI quattro			07.05	10.09	PR: 1LG					
6.0 W12 quattro			02.04	10.09	PR: 1LG						
2.8 FSI	154		08.07	10.09	PR: 1LJ,1LL,1LM	G1020678		23896 20,6 +/WI	ATE		
3.0			07.03	10.09	PR: 1LJ,1LL,1LM						
3.0 TDI quattro			11.03	10.09	PR: 1LJ,1LL,1LM						
3.2 FSI	191		06.05	10.09	PR: 1LJ,1LL,1LM						
3.2 FSI quattro	191		06.05	10.09	PR: 1LJ,1LL,1LM						
3.7 quattro			11.02	10.09	PR: 1LJ,1LL,1LM						
4.0 TDI quattro			03.03	10.09	PR: 1LJ,1LL,1LM						
4.2 FSI quattro	257		06.06	10.09	PR: 1LJ,1LL,1LM						
4.2 quattro			11.02	10.09	PR: 1LJ,1LL,1LM						
4.2 TDI quattro			07.05	10.09	PR: 1LJ,1LL,1LM						
6.0 W12 quattro			02.04	10.09	PR: 1LJ,1LL,1LM						
S8	331		06.06	10.09							
	2.8 FSI	154		08.07	10.09	PR: 1LG	G2130175		321 30,0 28,0 V L +S +C		
	3.0	4E-5-003251		10.09	10.09	PR: 1LG					
	3.0 TDI quattro	4E-5-003251		10.09	10.09	PR: 1LG					
	3.2 FSI	191	4E-5-003251		10.09	10.09					PR: 1LG
	3.2 FSI quattro	191	4E-5-003251		10.09	10.09					PR: 1LG
	3.7 quattro		4E-5-003251		10.09	10.09					PR: 1LG
	4.0 TDI quattro		4E-5-003251		10.09	10.09					PR: 1LG
	4.2 FSI quattro	257	4E-5-003251		10.09	10.09					PR: 1LG
	4.2 quattro		4E-5-003251		10.09	10.09					PR: 1LG

<sup>1)</sup> fr. di stazionamento elettrico / frein à main électrique / freno de mano eléctrico / elektrische Feststellbremse

<sup>2)</sup> - veicoli speciali / - véhicules spécial / - vehículo especial / - Sonderfahrzeuge



AUDI A8 (03-09)									
	4.2 TDI quattro 6.0 W12 quattro	4E-5-003251 4E-5-003251		10.09 10.09	PR: 1LG PR: 1LG	G2130175			321 30,0 28,0 V L +S +C
	2.8 FSI 3.0 3.0 TDI quattro 3.2 FSI 3.2 FSI quattro 3.7 quattro 4.0 TDI quattro 4.2 FSI quattro 4.2 quattro 4.2 TDI quattro 6.0 W12 quattro	154   191 191  257		08.07 10.09 07.03 11.03 06.05 06.05 11.02 03.03 06.06 11.02 07.05 02.04	10.09 PR: 1LL,1LM PR: 1LL,1LM PR: 1LL,1LM PR: 1LL,1LM PR: 1LL,1LM PR: 1LL,1LM PR: 1LL,1LM PR: 1LL,1LM PR: 1LL,1LM PR: 1LL,1LM PR: 1LL,1LM	G2134100			360 34,0 31,0 V L +C
	2.8 FSI 3.0 3.0 TDI quattro 3.2 FSI 3.2 FSI quattro 3.7 quattro 4.0 TDI quattro 4.2 FSI quattro 4.2 quattro 4.2 TDI quattro 6.0 W12 quattro S8	154  191 191  257 331		08.07 07.03 11.03 06.05 06.05 11.02 03.03 06.06 11.02 07.05 02.04 06.06	10.09 PR: 1KE,1KW,1KY,1KZ PR: 1KE,1KW,1KY,1KZ PR: 1KE,1KW,1KY,1KZ PR: 1KE,1KW,1KY,1KZ PR: 1KE,1KW,1KY,1KZ PR: 1KE,1KW,1KY,1KZ PR: 1KE,1KW,1KY,1KZ PR: 1KE,1KW,1KY,1KZ PR: 1KE,1KW,1KY,1KZ PR: 1KE,1KW,1KY,1KZ PR: 1KE,1KW,1KY,1KZ	G1020759		electric parking brake <sup>1)</sup>	23326 17,4 AWD/S LUC
AUDI CONVERTIBLE (91-00)									
	1.8 1.9 TDI 2.0 2.0 2.3 2.6			04.97 07.95 01.93 05.95 07.91 01.94	08.00 08.00 07.98 07.96 + ⊕ 06.94 08.00	G1020196			20669 19,0 /S LUC
	1.8 1.9 TDI 2.0 2.0 2.3 2.6 2.8	85 103		04.97 07.95 01.93 05.95 07.91 01.94 11.92	08.00 08.00 07.98 07.96 + ⊕ 06.94 08.00	G1020246			21144 15,8 /S LUC
	1.8 1.9 TDI 2.0 2.0 2.3 2.6 2.8	85 103		04.97 07.95 01.93 05.95 07.91 01.94 11.92	08.00 08.00 07.98 07.96 + ⊕ 06.94 08.00	G2110178			245 10,0 8,0 +C
AUDI COUPE (89-96)									
	1.8 2.0 2.2 2.3 2.3 2.6			08.88 08.88 11.88 03.90 11.88 08.92	07.91 12.96 07.91 12.96 07.94 12.96	G1020196			20669 19,0 /S LUC
	1.8 2.0 2.2 2.3 2.6 2.8	100		08.88 08.88 08.88 08.88 08.92 09.91	07.91 12.96 07.91 12.96 12.96	G1020246			21144 15,8 /S LUC
	1.8 2.0 2.2 2.3 2.6 2.8	100		08.88 08.88 08.88 08.88 08.92 09.91	07.91 12.96 07.91 07.94 12.96	G2110178			245 10,0 8,0 +C
AUDI COUPE Quattro (87-96)									
	2.2 2.3 2.3 2.6	100 98 100		01.88 05.90 01.88 08.92	07.91 12.96 07.94 12.96	G1020196			20669 19,0 /S LUC
	2.0 2.2 2.3 2.3 2.3 20V 2.3 20V 2.6 2.8 S2 2.2 S2 2.2	100 98 100 123 125  162 169		11.88 01.88 05.90 01.87 05.90 11.88 08.92 08.91 09.90 10.92	07.91 + ⊕ ⊕ 07.91 12.96 07.94 12.96 07.91 12.96 12.96 09.92 12.96	G1020246			21144 15,8 /S LUC

<sup>1)</sup> fr.di stazionamento elettrico / frein à main électrique / freno de mano eléctrico / elektrische Feststellbremse





AUDI COUPE Quattro (87-96)							
	2.6 2.8 S2 2.2	169	08.92 08.91 10.92	12.96 + 16" wheel <sup>1)</sup> 12.96 + 16" wheel <sup>1)</sup> 12.96 + 16" wheel <sup>1)</sup>	G2110261		245 10,0 8,0 +C
AUDI Q3 (11-)							
	2.0 TDI 2.0 TDI 2.0 TDI quattro 2.0 TDI quattro 2.0 TFSI quattro 2.0 TFSI quattro	103 130 103 130 125 155	06.11 05.13 01.12 06.11 06.11 06.11	PR: 1LJ PR: 1LJ PR: 1LJ PR: 1LJ PR: 1LJ PR: 1LJ	G1020992		24332 19,8 +/Wl ATE
	2.0 TDI 2.0 TDI 2.0 TDI quattro 2.0 TDI quattro 2.0 TFSI quattro 2.0 TFSI quattro	103 130 103 130 125 155	06.11 05.13 01.12 06.11 06.11 06.11	PR: 1LJ PR: 1LJ PR: 1LJ PR: 1LJ PR: 1LJ PR: 1LJ	G2125158		312 25,0 22,0 V L +S +C
	2.0 TDI 2.0 TDI 2.0 TDI quattro 2.0 TDI quattro 2.0 TFSI quattro 2.0 TFSI quattro	103 130 103 130 125 155	06.11 05.13 01.12 06.11 06.11 06.11	PR: 1KU PR: 1KU PR: 1KU PR: 1KU PR: 1KU PR: 1KU	G1020993	electric parking brake <sup>2)</sup>	24483 16,9 /Acc/S LUC
	2.0 TDI 2.0 TDI 2.0 TDI quattro 2.0 TDI quattro 2.0 TFSI quattro 2.0 TFSI quattro	103 130 103 130 125 155	06.11 05.13 01.12 06.11 06.11 06.11	PR: 1KU PR: 1KU PR: 1KU PR: 1KU PR: 1KU PR: 1KU	G2112169	electric parking brake <sup>2)</sup>	282 12,0 10,0 +S +C
AUDI Q5 (08-)							
	2.0 TDI 2.0 TDI 2.0 TDI 2.0 TDI quattro 2.0 TDI quattro 2.0 TDI quattro 2.0 TDI quattro 2.0 TDI quattro 2.0 TFSI hybr.quattro 2.0 TFSI quattro 2.0 TFSI quattro 2.0 TFSI quattro 2.0 TFSI quattro 3.0 TDI quattro 3.0 TDI quattro 3.0 TDI quattro 3.0 TFSI quattro 3.2 FSI quattro S 3.0 TDI quattro	100 105 110 100 105 110 120 125 130 155 132 155 162 165 155 176 180 200 199 230	07.11 07.11 05.13 08.09 08.09 05.13 07.11 07.11 09.12 07.11 07.11 05.13 09.12 07.11 07.11 09.12 09.12 07.11 12.12	PR: 1LJ PR: 1LJ PR: 1LJ PR: 1LJ PR: 1LJ PR: 1LJ PR: 1LJ PR: 1LJ PR: 1LJ PR: 1LJ PR: 1LJ PR: 1LJ PR: 1LJ PR: 1LJ PR: 1LJ PR: 1LJ PR: 1LJ PR: 1LJ PR: 1LJ	G1020823		24705 19,8 +/Wl ATE
	2.0 TDI 2.0 TDI 2.0 TDI 2.0 TDI quattro 2.0 TDI quattro 2.0 TDI quattro 2.0 TDI quattro 2.0 TDI quattro 2.0 TFSI hybr.quattro 2.0 TFSI quattro 2.0 TFSI quattro 2.0 TFSI quattro 2.0 TFSI quattro 3.0 TDI quattro 3.0 TDI quattro 3.0 TDI quattro 3.0 TFSI quattro 3.2 FSI quattro S 3.0 TDI quattro	100 105 110 100 105 110 120 125 130 155 132 155 162 165 155 176 180 200 199 230	08.09 08.09 05.13 08.09 08.09 05.13 03.09 03.09 09.12 06.11 08.09 03.09 05.13 09.12 03.09 03.09 09.12 09.12 03.09 12.12	PR: 1KW,2EK PR: 1KW,2EK PR: 1KW,2EK PR: 1KW,2EK PR: 1KW,2EK PR: 1KW,2EK PR: 1KW,2EK PR: 1KW,2EK PR: 1KW,2EK PR: 1KW,2EK PR: 1KW,2EK PR: 1KW,2EK PR: 1KW,2EK PR: 1KW,2EK PR: 1KW,2EK PR: 1KW,2EK PR: 1KW,2EK PR: 1KW,2EK PR: 1KW,2EK	G1201004	electric parking brake <sup>2)</sup>	24606 17,4 +/Acc/S LUC
	2.0 TDI 2.0 TDI 2.0 TDI 2.0 TDI quattro 2.0 TDI quattro 2.0 TDI quattro 2.0 TDI quattro 2.0 TDI quattro 2.0 TFSI hybr.quattro 2.0 TFSI quattro 2.0 TFSI quattro 2.0 TFSI quattro 2.0 TFSI quattro 3.0 TDI quattro 3.0 TDI quattro 3.0 TDI quattro 3.0 TFSI quattro 3.2 FSI quattro S 3.0 TDI quattro	100 105 110 100 105 110 120 125 130 155 132 155 162 165 155 176 180 200 199 230	08.09 08.09 05.13 08.09 08.09 05.13 03.09 03.09 09.12 06.11 08.09 03.09 05.13 09.12 03.09 03.09 09.12 09.12 03.09 12.12	PR: 1KE PR: 1KE PR: 1KE PR: 1KE PR: 1KE PR: 1KE PR: 1KE PR: 1KE PR: 1KE PR: 1KE PR: 1KE PR: 1KE PR: 1KE PR: 1KE PR: 1KE PR: 1KE PR: 1KE PR: 1KE PR: 1KE	G1201005	electric parking brake <sup>2)</sup>	24606 17,4 +/Acc/S LUC

<sup>1)</sup> + ruota 16" / + roue 16" / + rueda 16" / + 16" Rad

<sup>2)</sup> fr.di stazionamento elettrico / frein à main électrique / freno de mano eléctrico / elektrische Feststellbremse





















AUDI Q5 (08-)									
	3.0 TDI quattro	176		03.09	PR: 1KE	G1201005	electric parking brake <sup>1)</sup>	24606 17,4 +/Acc/S	LUC
	3.0 TDI quattro	180		09.12	PR: 1KE				
	3.0 TFSI quattro	200		09.12	PR: 1KE				
	3.2 FSI quattro	199		03.09	PR: 1KE				
	S 3.0 TDI quattro	230		12.12	PR: 1KE,1KF				
	2.0 TDI	100		08.09	PR: 1KW,2EK	G2112178	electric parking brake <sup>1)</sup>	300 12,0 10,0 +S +C	
	2.0 TDI	105		08.09	PR: 1KW,2EK				
	2.0 TDI	110		05.13	PR: 1KW,2EK				
	2.0 TDI quattro	100		08.09	PR: 1KW,2EK				
	2.0 TDI quattro	105		08.09	PR: 1KW,2EK				
	2.0 TDI quattro	110		05.13	PR: 1KW,2EK				
	2.0 TDI quattro	120		03.09	PR: 1KW,2EK				
	2.0 TDI quattro	125		03.09	PR: 1KW,2EK				
	2.0 TDI quattro	130		09.12	PR: 1KW,2EK				
	2.0 TFSI hybr.quattro	155		06.11	PR: 1KW,2EK				
	2.0 TFSI quattro	132		08.09	PR: 1KW,2EK				
	2.0 TFSI quattro	155		03.09	PR: 1KW,2EK				
	2.0 TFSI quattro	162		05.13	PR: 1KW,2EK				
	2.0 TFSI quattro	165		09.12	PR: 1KW,2EK				
	3.0 TDI quattro	155		03.09	PR: 1KW,2EK				
	3.0 TDI quattro	176		03.09	PR: 1KW,2EK				
	3.0 TDI quattro	180		09.12	PR: 1KW,2EK				
	3.0 TFSI quattro	200		09.12	PR: 1KW,2EK				
	3.2 FSI quattro	199		03.09	PR: 1KW,2EK				
	S 3.0 TDI quattro	230		12.12	PR: 1KW,2EK				
	AUDI Q7 (06-)								
	3.0 TDI	150		05.10	PR: 1LF	G1020710		23693 16,6 /WD	BRE
	3.0 TDI	155		03.06	PR: 1LF				
	3.0 TDI	165		06.09	PR: 1LF				
	3.0 TDI	171		03.06	PR: 1LF				
	3.0 TDI	176		11.07	PR: 1LF				
	3.0 TDI	180		05.11	PR: 1LF				
	3.0 TFSI	200		05.10	PR: 1LF				
3.6 FSI	206		08.06	PR: 1LF					
	3.0 TFSI	245		05.10	PR: 1LF	G1020710		23693 16,6 /WD	BRE
	4.2 FSI	257		03.06	PR: 1LF				
	4.2 TDI	240		03.07	PR: 1LF				
	6.0 TDI	368		09.08	PR: 1LF				
	3.0 TDI	150		05.10	PR: 1KF,2EA	G1020711		23694 16,4 /WD	BRE
	3.0 TDI	155		03.06	PR: 1KF,2EA				
	3.0 TDI	165		06.09	PR: 1KF,2EA				
	3.0 TDI	171		03.06	PR: 1KF,2EA				
	3.0 TDI	176		11.07	PR: 1KF,2EA				
	3.0 TDI	180		05.11	PR: 1KF,2EA				
	3.0 TFSI	200		05.10	PR: 1KF,2EA				
	3.0 TFSI	245		05.10	PR: 1KF,2EA				
	3.6 FSI	206		08.06	PR: 1KF,2EA				
	4.2 FSI	257		03.06	PR: 1KF,2EA				
	4.2 TDI	240		03.07	PR: 1KF,2EA				
	6.0 TDI	368		09.08	PR: 1KF,2EA				
		3.0 TDI	150		05.10				
3.0 TDI		155		03.06	PR: 1KD				
3.0 TDI		165		06.09	PR: 1KD				
3.0 TDI		171		03.06	PR: 1KD				
3.0 TDI		176		11.07	PR: 1KD				
3.0 TDI		180		05.11	PR: 1KD				
3.0 TFSI		200		05.10	PR: 1KD				
3.0 TFSI		245		05.10	PR: 1KD				
3.6 FSI		206		08.06	PR: 1KD				
4.2 FSI		257		03.06	PR: 1KD				
4.2 TDI		240		03.07	PR: 1KD				
6.0 TDI		368		09.08	PR: 1KD				
AUDI TT Coupe (98-06)									
	1.8 T	110		09.02	06.06 PR: 1LD,1LT,1LV	G1020379		21911 20,3 +	ATE
	1.8 T	120		09.05	06.06 PR: 1LD,1LT,1LV				
	1.8 T	132		10.98	06.06 PR: 1LD,1LT,1LV	G1020512		23392 20,3 +/WL	ATE
	1.8 T	140		09.05	06.06 PR: 1LD,1LT,1LV				
	1.8 T quattro	132		10.98	06.06 PR: 1LD,1LT,1LV	G1020683		21484 20,5 +/WD	ATE
	1.8 T quattro	140		09.05	06.06 PR: 1LD,1LT,1LV				
	1.8 T quattro	165		10.98	06.06 PR: 1LD,1LT,1LV	G1020755		20961 17,1 /Acc/S	LUC
	1.8 T quattro	176		03.05	06.06 PR: 1LD,1LT,1LV				
	3.2 quattro	184		04.03	06.06	G1020683		21484 20,5 +/WD	ATE
	1.8 T	110		09.02	06.06 PR: 1LD,1LT,1LV	G2125123		310 25,0 22,0 V L +C	
	1.8 T	120		09.05	06.06 PR: 1LD,1LT,1LV				
	1.8 T	132		10.98	06.06 PR: 1LD,1LT,1LV				
	1.8 T	140		09.05	06.06 PR: 1LD,1LT,1LV				
	1.8 T quattro	132		10.98	06.06 PR: 1LD,1LT,1LV				
	1.8 T quattro	140		09.05	06.06 PR: 1LD,1LT,1LV				
	1.8 T quattro	165		10.98	06.06 PR: 1LD,1LT,1LV				
1.8 T quattro	176		03.05	06.06 PR: 1LD,1LT,1LV					
	1.8 T	110		09.02	06.06 PR: 1KE,1KK,2EK	G1020755		20961 17,1 /Acc/S	LUC
	1.8 T	120		09.05	06.06 PR: 1KE,1KK,2EK				
	1.8 T	132		10.98	06.06 PR: 1KE,1KK,2EK				
	1.8 T	140		09.05	06.06 PR: 1KE,1KK,2EK				

<sup>1)</sup> fr. di stazionamento elettrico / frein à main électrique / freno de mano eléctrico / elektrische Feststellbremse







													
<b>AUDI TT Coupe (06-)</b>													
	1.8 TFSI	118		06.08	PR: 1LK,1LM,1LN	G1020895		23801 20,3 +/WI	ATE				
	2.0 quattro	195		05.08	PR: 1LK,1LM,1LN								
	2.0 TDI quattro	125		06.08	PR: 1LK,1LM,1LN								
	2.0 TFSI	147		07.06	PR: 1LK,1LM,1LN								
	2.0 TFSI	155		05.10	PR: 1LK,1LM,1LN								
	2.0 TFSI quattro	147		05.08	PR: 1LK,1LM,1LN								
	2.0 TFSI quattro	155		05.10	PR: 1LK,1LM,1LN								
	3.2 quattro	184		07.06	PR: 1LK,1LM,1LN								
	TTS 2.0 TFSI	200		05.08	PR: 1LN								
	RS 2.5 TFSI	250		05.09	PR: 1LA					G1201010		24098 17,1 /WD	BRE
RS 2.5 TFSI plus	265		05.11	PR: 1LA									
	1.8 TFSI	118		06.08	PR: 1LJ,1LL	G2125158		312 25,0 22,0 V L +S +C					
	2.0 quattro	195		05.08	PR: 1LJ,1LL								
	2.0 TDI quattro	125		06.08	PR: 1LJ,1LL								
	2.0 TFSI	147		07.06	PR: 1LJ,1LL								
	2.0 TFSI	155		05.10	PR: 1LJ,1LL								
	2.0 TFSI quattro	147		05.08	PR: 1LJ,1LL								
	2.0 TFSI quattro	155		05.10	PR: 1LJ,1LL								
	3.2 quattro	184		07.06	PR: 1LJ,1LL								
	1.8 TFSI	118		06.08	PR: 1KZ,2ED	G1020682		23914 17,1 /WD/Acc/S	LUC				
	2.0 quattro	195		05.08	PR: 1KJ,2EE								
	2.0 TDI quattro	125		06.08	PR: 1KJ,2EE								
	2.0 TFSI	147		07.06	PR: 1KZ,2ED								
	2.0 TFSI	155		05.10	PR: 1KZ,2ED								
	2.0 TFSI quattro	147		05.08	PR: 1KJ,2EE								
	2.0 TFSI quattro	155		05.10	PR: 1KJ,2EE								
	3.2 quattro	184		07.06	PR: 1KJ,2EE								
	TTS 2.0 TFSI	200		05.08	PR: 1KJ,2EE								
	RS 2.5 TFSI	250		05.09						G1020682		23914 17,1 /WD/Acc/S	LUC
RS 2.5 TFSI plus	265		05.11										
<b>AUDI TT Roadster (07-)</b>													
	1.8 TFSI	118		06.08	PR: 1LK,1LM,1LN	G1020895		23801 20,3 +/WI	ATE				
	2.0 quattro	195		05.08	PR: 1LK,1LM,1LN								
	2.0 TDI quattro	125		06.08	PR: 1LK,1LM,1LN								
	2.0 TFSI	147		02.07	PR: 1LK,1LM,1LN								
	2.0 TFSI	155		05.10	PR: 1LK,1LM,1LN								
	2.0 TFSI quattro	147		05.08	PR: 1LK,1LM,1LN								
	2.0 TFSI quattro	155		05.10	PR: 1LK,1LM,1LN								
	3.2 quattro	184		02.07	PR: 1LK,1LM,1LN								
	TTS 2.0 TFSI	200		05.08	PR: 1LN								
	RS 2.5 TFSI	250		05.09	PR: 1LA					G1201010		24098 17,1 /WD	BRE
RS 2.5 TFSI plus	265		02.12	PR: 1LA									
	1.8 TFSI	118		06.08	PR: 1LJ,1LL	G2125158		312 25,0 22,0 V L +S +C					
	2.0 quattro	195		05.08	PR: 1LJ,1LL								
	2.0 TDI quattro	125		06.08	PR: 1LJ,1LL								
	2.0 TFSI	147		02.07	PR: 1LJ,1LL								
	2.0 TFSI	155		05.10	PR: 1LJ,1LL								
	2.0 TFSI quattro	147		05.08	PR: 1LJ,1LL								
	2.0 TFSI quattro	155		05.10	PR: 1LJ,1LL								
	3.2 quattro	184		02.07	PR: 1LJ,1LL								
	RS 2.5 TFSI	250		05.09	PR: 1LJ,1LL								
	1.8 TFSI	118		06.08	PR: 1KZ,2ED	G1020682		23914 17,1 /WD/Acc/S	LUC				
	2.0 quattro	195		05.08	PR: 1KJ,2EE								
	2.0 TDI quattro	125		06.08	PR: 1KJ,2EE								
	2.0 TFSI	147		02.07	PR: 1KZ,2ED								
	2.0 TFSI	155		05.10	PR: 1KZ,2ED								
	2.0 TFSI quattro	147		05.08	PR: 1KJ,2EE								
	2.0 TFSI quattro	155		05.10	PR: 1KJ,2EE								
	3.2 quattro	184		02.07	PR: 1KJ,2EE								
	RS 2.5 TFSI	250		05.09						G1020682		23914 17,1 /WD/Acc/S	LUC
	RS 2.5 TFSI plus	265		02.12									
<b>BENTLEY ARNAGE</b>													
	4.4 V8			04.98		G1020683		21484 20,5 +/WD	ATE				
	6.8 V8			09.99									
<b>BENTLEY AZURE</b>													
	6.75 V8			08.99		G1020683		21484 20,5 +/WD	ATE				
<b>BENTLEY CONTINENTAL</b>													
	6.0			06.03		G1020683		21484 20,5 +/WD	ATE				
	6.75 V8			08.99									
	6.0			06.03		G1020758		23326 17,4 /WD/S	LUC				
	6.75 V8			08.99									





BMW 1 series/E82 Coupe (07-13)													
	118 d	105		09.09	02.10	G1020850	- Performance Parts	23926 17,3 +/WD	ATE				
	120 d	130		10.07	02.10								
	120 i	115		09.09	02.10								
	120 i	125		09.09	02.10								
	123 d	150		10.07	02.10								
	125 i	160		03.08	02.10								
	118 d	105		03.10	10.13					G1020850	- Performance Parts	23926 17,3 +/WD	ATE
	120 d	130		03.10	10.13								
	120 i	115		03.10	10.13								
	120 i	125		03.10	10.13								
123 d	150		03.10	10.13									
125 i	160		03.10	10.13									
3.0 M	250		05.11	10.13	G1020638		23309 17,3 +/WD	ATE					
BMW 1 series/E88 Convertible (08-13)													
	118 d	105		09.08	02.10	G1020794	- Performance Parts	23915 17,6 +/WD/Acc/S	LUC				
	118 i	105		03.08	02.10								
	118 d	105		03.10	10.13	G1020794	- Performance Parts	23915 17,6 +/WD/Acc/S	LUC				
	118 i	105		03.10	10.13								
	120 d	130		03.08	02.10	G1020848	- Performance Parts	23794 20,3 +/WD	ATE				
	120 d	145		03.08	02.10								
	120 i	115		03.08	02.10								
	120 i	125		03.08	02.10								
	125 i	160		03.08	02.10								
	120 d	130		03.10	10.13					G1020848	- Performance Parts	23794 20,3 +/WD	ATE
120 d	145		03.10	10.13									
120 i	115		03.10	10.13									
120 i	125		03.10	10.13									
125 i	160		03.10	10.13									
118 d	105		09.08	10.13	G2122238	- Performance Parts	292 22,0 20,4 V L +S +C						
118 i	105		03.08	10.13									
	120 d	130		03.08	10.13	G2124197	- Performance Parts	300 24,0 22,4 V L +S +C					
	120 d	145		03.08	10.13								
	120 i	115		03.08	10.13								
	120 i	125		03.08	10.13								
	125 i	160		03.08	10.13								
	118 d	105		09.08	02.10					G1020850	- Performance Parts	23926 17,3 +/WD	ATE
118 i	105		03.08	02.10									
120 d	130		03.08	02.10									
120 d	145		03.08	02.10									
120 i	115		03.08	02.10									
120 i	125		03.08	02.10									
123 d	150		09.08	02.10									
125 i	160		03.08	02.10									
118 d	105		03.10	10.13	G1020850	- Performance Parts	23926 17,3 +/WD	ATE					
118 i	105		03.10	10.13									
120 d	130		03.10	10.13									
120 d	145		03.08	10.13									
120 i	115		03.10	10.13									
120 i	125		03.10	10.13									
123 d	150		03.10	10.13									
125 i	160		03.10	10.13									
BMW 3 series/E36 (91-00)													
	316 g Compact			12.95	08.00	G1020608		21643 17,8 +/WD	ATE				
	316 i			12.90	02.98								
	316 i Compact 1.6			09.93	08.00								
	316 i Compact 1.9			12.98	08.00								
	316 i Coupe			03.93	04.99								
	316 i Touring			05.97	10.99								
	318 i			12.90	02.98								
	318 i Convertible			11.93	04.99								
	318 i Touring			02.95	10.99								
	318 iS			01.92	02.98								
	318 iS Coupe			01.92	04.99								
	318 tds			01.94	02.98								
	318 tds Compact			04.94	08.00								
	318 tds Touring			10.94	10.99								
	318 ti Compact			04.94	08.00								
	320 i			12.90	02.98								
	320 i Convertible			11.93	04.99								
	320 i Coupe			01.92	04.99								
	320 i Touring			05.94	10.99								
	323 i			03.95	02.98								
	323 i Convertible			03.95	04.99								
	323 i Coupe			03.95	04.99								
	323 i Touring			07.95	10.99								
	323 ti Compact			08.97	08.00								
	325 i			12.90	02.98								
	325 i Convertible			08.92	03.95								
	325 i Coupe			01.92	04.99								
	325 td			09.91	02.98								
	325 tds			03.93	02.98								
	325 tds Touring			10.94	10.99								
	328 i			11.94	02.98								
	328 i Convertible			11.94	04.99								





**BMW 3 series/E36 (91-00)**

	328 i Coupe		11.94	04.99	G1020608	21643 17,8 +WD	ATE			
	328 i Touring		10.94	10.99						
	M3		06.94	02.98	G1020474	20968 20,3 +WD	ATE			
	M3 Convertible		11.93	04.99						
M3 Coupe		03.92	04.99							
	316 g Compact		12.95	08.00	G2112126	286 12,0 10,4 +S +C				
	316 i		12.90	02.98						
	316 i Compact 1.6		09.93	08.00						
	316 i Compact 1.9		12.98	08.00						
	316 i Coupe		03.93	04.99						
	316 i Touring		05.97	10.99						
	318 i		12.90	02.98						
	318 i Convertible		11.93	04.99						
	318 i Touring		02.95	10.99						
	318 tds		01.94	02.98						
	318 tds Compact		04.94	08.00						
	318 tds Touring		10.94	10.99						
	318 ti Compact		04.94	03.98						
	316 i Touring		05.97	10.99						
	318 i		12.90	02.98						
	318 i Touring		02.95	10.99						
	318 iS		01.92	02.98						
	318 iS Coupe		01.92	04.99						
	318 tds		01.94	02.98						
	318 ti Compact		04.98	08.00						
	320 i		12.90	02.98						
	320 i Convertible		11.93	04.99						
	320 i Coupe		01.92	04.99						
	320 i Touring		05.94	10.99						
	323 i		03.95	02.98						
	323 i Convertible		03.95	04.99						
	323 i Coupe		03.95	04.99						
	323 i Touring		07.95	10.99						
	323 ti Compact		08.97	08.00						
	325 i		12.90	02.98						
	325 i Convertible		08.92	03.95						
	325 i Coupe		01.92	04.99						
	325 td		09.91	02.98						
	325 tds		03.93	02.98						
325 tds Touring		10.94	10.99							
328 i		11.94	02.98							
328 i Convertible		11.94	04.99							
328 i Coupe		11.94	04.99							
328 i Touring		10.94	10.99							
	316 g Compact		12.95	08.00	G1020316	20180 17,1 +WD	ATE			
	316 i Compact 1.6		09.93	08.00						
	316 i Compact 1.9		12.98	08.00						
	318 tds Compact		04.94	08.00						
	318 ti Compact		04.94	08.00						
	323 ti Compact		08.97	08.00						
	316 i		12.90	02.98				G1020316	20180 17,1 +WD	ATE
	316 i Touring		05.97	10.99						
	318 i		12.90	12.98						
	318 i Convertible		11.93	04.99						
	318 i Touring		02.95	10.99						
318 iS		01.92	02.98							
318 iS Coupe		01.92	04.99							
318 tds		01.94	02.98							
318 tds Touring		10.94	10.98							
320 i		12.90	02.98							
320 i Convertible		11.93	04.99							
320 i Coupe		01.92	04.99							
320 i Touring		05.94	10.99							
323 i		03.95	02.98							
323 i Convertible		03.95	04.99							
323 i Coupe		03.95	04.99							
323 i Touring		07.95	10.99							
325 i		12.90	02.98							
325 i Convertible		08.92	03.95							
325 i Coupe		01.92	04.99							
325 td		09.91	02.98							
325 tds		03.93	02.98							
325 tds Touring		10.94	10.99							
328 i		11.94	02.98							
328 i Convertible		11.94	04.99							
328 i Coupe		11.94	04.99							
328 i Touring		10.94	10.99							
	M3		06.94	02.98	G1020308	20995 17,1 +WD	ATE			
	M3 Convertible		11.93	04.99						
	M3 Coupe		03.92	04.99						
	316 g Compact		12.95	08.00	G2110211	272 10,0 8,4 L +S +C				
	316 i Compact 1.6		09.93	08.00						
	316 i Compact 1.9		12.98	08.00						
	318 tds Compact		04.94	08.00						
	318 ti Compact		04.94	08.00						
323 ti Compact		08.97	08.00							

1) - enti statali / - véhicule communal / - vehiculos oficiales / - Behörde  
 2) + enti statali / + véhicule communal / + vehiculos oficiales / + Behörde



**BMW 3 series/E36 (91-00)**

	316 i		12.90	02.98	G2110202		280 10,0 8,4 L +S +C
	316 i Touring		05.97	10.99			
	318 i		12.90	02.98			
	318 i Convertible		11.93	04.99			
	318 i Touring		02.95	10.99			
	318 iS		01.92	02.98			
	318 iS Coupe		01.92	04.99			
	318 tds		01.94	02.98			
	318 tds Touring		10.94	10.99			
	320 i		12.90	02.98			
	320 i Convertible		11.93	04.99			
	320 i Coupe		01.92	04.99			
	320 i Touring		05.94	10.99			
	325 i		12.90	02.98			
	325 i Convertible		08.92	03.95			
	325 i Coupe		01.92	04.99			
	325 td		09.91	02.98			
	325 tds		03.93	02.98			
	325 tds Touring		10.94	10.99			
	328 i		11.94	02.98			
328 i Convertible		11.94	04.99				
323 i		03.95	02.98	G2119107		276 19,0 17,4 VL +S +C	
323 i Convertible		03.95	04.99				
323 i Coupe		03.95	04.99				
323 i Touring		07.95	10.99				
328 i		11.94	02.98				
328 i Convertible		11.94	04.99				
328 i Coupe		11.94	04.99				
328 i Touring		10.94	10.99				

**BMW 3 series/E46 (98-06)**

	325 Ci Convertible	141	10.00	12.06	G1020608		21643 17,8 +WD	ATE	
	316 i		12.98	02.05					
	316 i 1.9	77	12.98	02.05					
	316 i Coupe		04.00	08.05					
	316 i Touring	85	03.02	07.05					
	316 ti Compact	85	07.01	02.05					
	318 Ci Convertible	105	09.01	12.06					
	318 Ci Convertible	110	02.05	12.06					
	318 d	85	09.01	02.05					
	318 d Touring	85	03.02	07.05					
	318 i		04.98	02.05					
	318 i Coupe		08.99	08.05					
	318 i Touring		10.99	07.05					
	318 td Compact		03.03	02.05					
	318 ti Compact		09.01	02.05					
	320 Cd Convertible	110	02.05	12.06					
	320 Cd Coupe	110	11.03	08.06					
	320 Ci Convertible	125	10.00	12.06					
	320 Ci Coupe		06.99	08.06					
	320 d	100	04.98	09.01					
	320 d	110	09.01	02.05					
	320 d Touring		03.00	07.05					
	320 i	110	04.98	09.00					
	320 i	125	09.00	02.05					
	320 i Touring		10.99	07.05					
	320 td Compact		09.01	02.05					
	323 Ci Convertible	125	05.00	12.06					
	323 Ci Coupe	125	04.99	08.00					
	323 i	125	04.98	08.00					
	325 Ci Coupe	141	10.00	08.06					
	325 i	141	10.00	02.05					- authority cars <sup>1)</sup>
	325 i Touring	141	10.00	07.05					
	325 ti Compact	141	07.01	02.05					
325 xi Touring	141	10.00	07.05						
328 Ci Coupe	142	04.99	06.00						
328 i	142	04.98	06.00						
328 i Touring	142	10.99	06.00						
325 xi	141	10.00	02.05	- authority cars <sup>1)</sup>	G1020608		21643 17,8 +WD	ATE	
325 i	141	10.00	02.05	+ authority cars <sup>2)</sup>	G1020591		23183 20,3 +WD	ATE	
325 xi	141	10.00	02.05	+ authority cars <sup>2)</sup>	G1020591		23183 20,3 +WD	ATE	
330 Ci Convertible	170	09.00	12.06	G1020591		23183 20,3 +WD	ATE		
330 Cd Convertible	150	05.05	12.06						
330 Cd Coupe	150	03.03	08.06						
330 Ci Coupe	170	09.00	08.06						
330 d		10.99	02.05						
330 d Touring		03.00	07.05						
330 i	168	01.01	04.05						
330 i	170	09.00	02.05						
330 i Touring	170	06.00	07.05						
330 xd		10.99	02.05						
330 xd Touring		03.00	07.05						
330 xi	170	09.00	02.05						
330 xi Touring	170	09.00	07.05						

<sup>1)</sup> - enti statali / - véhicule communal / - vehiculos oficiales / - Behörde  
<sup>2)</sup> + enti statali / + véhicule communal / + vehiculos oficiales / + Behörde



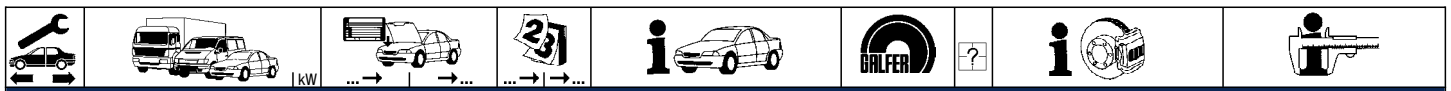

**BMW 3 series/E46 (98-06)**

	316 i		12.98	02.05	G2122115	286 22,0 20,4 V L +S +C			
	316 i 1.9	77	12.98	02.05					
	316 i Coupe		04.00	08.06					
	316 i Touring	85	03.02	07.05					
	316 ti Compact	85	07.01	02.05					
	318 Ci Convertible	105	09.01	12.06					
	318 Ci Convertible	110	02.05	12.06					
	318 d	85	09.01	02.05					
	318 d Touring	85	03.02	07.05			- authority cars <sup>1)</sup>		
	318 i		04.98	02.05			- authority cars <sup>1)</sup>		
	318 i Coupe		08.99	08.06					
	318 i Touring		10.99	07.05			- authority cars <sup>1)</sup>		
	318 td Compact		03.03	02.05					
	318 ti Compact		09.01	02.05					
	320 Ci Coupe		06.99	08.06					
	320 d	100	04.98	09.01					
	320 d Touring		03.00	08.01			- authority cars <sup>1)</sup>		
	320 i	110	04.98	09.00			- authority cars <sup>1)</sup>		
	320 i	125	09.00	02.05			- authority cars <sup>1)</sup>		
	320 i Touring		10.99	07.05			- authority cars/+engine co.M52 <sup>2)</sup>		
	323 Ci Coupe	125	04.99	08.00					
	323 i	125	04.98	08.00			- authority cars <sup>1)</sup>		
	325 Ci Convertible	141	10.00	12.06			G2122160	300 22,0 20,4 V L +S +C	
	318 d Touring	85	03.02	07.05					+ authority cars <sup>3)</sup>
	318 i		04.98	02.05					+ authority cars <sup>3)</sup>
	318 i Touring		10.99	07.05					+ authority cars <sup>3)</sup>
	320 Cd Convertible	110	02.05	12.06					
320 Cd Coupe	110	11.03	08.06						
320 Ci Convertible	125	10.00	12.06						
320 d	110	09.01	02.05						
320 d Touring		03.00	07.05	+ authority cars <sup>3)</sup>					
320 d Touring		09.01	07.05	- authority cars <sup>1)</sup>					
320 i	110	04.98	09.00	+ authority cars <sup>3)</sup>					
320 i	125	09.00	02.05	+ authority cars <sup>3)</sup>					
320 i Touring		10.99	07.05	+ engine code M54 <sup>4)</sup>					
320 i Touring		10.99	07.05	+ authority cars/+engine no.M52 <sup>5)</sup>					
320 td Compact		09.01	02.05						
323 Ci Convertible	125	05.00	08.00						
323 i	125	04.98	08.00	+ authority cars <sup>3)</sup>					
325 Ci Coupe	141	10.00	08.06						
325 i	141	10.00	02.05	- authority cars <sup>1)</sup>					
325 i Touring	141	10.00	07.05						
325 ti Compact	141	07.01	02.05						
325 xi	141	10.00	02.05	- authority cars <sup>1)</sup>					
325 xi Touring	141	10.00	07.05						
328 Ci Coupe	142	04.99	06.00						
328 i	142	04.98	06.00						
328 i Touring	142	10.99	06.00						
330 Ci Convertible	170	09.00	12.06	G2125138	325 24,9 23,4 V L +S +C				
325 i	141	10.00	02.05			+ authority cars <sup>3)</sup>			
325 xi	141	10.00	02.05			+ authority cars <sup>3)</sup>			
330 Cd Convertible	150	05.05	12.06						
330 Cd Coupe	150	03.03	08.06						
330 Ci Coupe	170	09.00	08.06						
330 d		10.99	02.05						
330 d Touring		03.00	07.05						
330 i	168	01.01	04.05						
330 i	170	09.00	02.05						
330 i Touring	170	06.00	07.05						
330 xd		10.99	02.05						
330 xd Touring		03.00	07.05						
330 xi	170	09.00	02.05						
330 xi Touring	170	09.00	07.05						
	325 Ci Convertible	141	10.00			12.06	G1020316	20180 17,1 +WD ATE	
	316 i		12.98			02.05			
	316 i 1.9	77	12.98	02.05					
	316 i Coupe		04.00	08.06					
	316 i Touring	85	03.02	07.05					
	316 ti Compact	85	07.01	02.05					
	318 Ci Convertible	105	09.01	12.06					
	318 Ci Convertible	110	02.05	12.06					
	318 d	85	09.01	02.05					
	318 d Touring	85	03.02	07.05					
	318 i		04.98	02.05					
	318 i Coupe		08.99	08.06					
	318 i Touring		10.99	07.05					
	318 td Compact		03.03	02.05					
	318 ti Compact		09.01	02.05					
	320 Cd Convertible	110	02.05	12.06					
	320 Cd Coupe	110	11.03	08.06					
	320 Ci Convertible	125	10.00	12.06					
	320 Ci Coupe		06.99	08.06					
	320 d	100	04.98	09.01					
	320 d	110	09.01	02.05					
	320 d Touring		03.00	07.05					
	320 i	110	04.98	09.00					
	320 i	125	09.00	02.05					

<sup>1)</sup> - enti statali / - véhicule communal / - vehiculos oficiales / - Behörde

<sup>2)</sup> - enti statali/+codice mot.M52 / - véhicule communal/+moteur co.M52 / - vehiculos oficiales/+motor co.M52 / - Behörde/ + Motorcode M52

<sup>3)</sup> + enti statali / + véhicule communal / + vehiculos oficiales / + Behörde

<sup>4)</sup> + codice motore M54 / + moteur code M54 / + motor code M54 / + Motorcode M54

<sup>5)</sup> + enti statali/+codice mot.M52 / + véhicule communal/+moteur co.M52 / + vehiculos oficiales/+motor co.M52 / + Behörde/ + Motorcode M52



**BMW 3 series/E46 (98-06)**

	320 i Touring		10.99	07.05	G1020316		20180 17,1 +/WD	ATE	
	320 td Compact		09.01	02.05					
	323 Ci Convertible	125	05.00	12.06					
	323 Ci Coupe	125	04.99	08.00					
	323 i	125	04.98	08.00					
	325 Ci Coupe	141	10.00	08.06					
	325 i	141	10.00	02.05					- authority cars <sup>1)</sup>
	325 i Touring	141	10.00	07.05					
	325 ti Compact	141	07.01	02.05					
	325 xi	141	10.00	02.05					- authority cars <sup>1)</sup>
	325 xi Touring	141	10.00	07.05					
	328 Ci Coupe	142	04.99	06.00					
	328 i	142	04.98	06.00					
328 i Touring	142	10.99	06.00						
	330 Ci Convertible	170	09.00	12.06	G1020367		21487 17,3 +/WD	ATE	
	325 i	141	10.00	02.05					+ authority cars <sup>2)</sup>
	325 xi	141	10.00	02.05					+ authority cars <sup>2)</sup>
	330 Cd Convertible	150	05.05	12.06					
	330 Cd Coupe	150	03.03	08.06					
	330 Ci Coupe	170	09.00	08.06					
	330 d		10.99	02.05					
	330 d Touring		03.00	07.05					
	330 i	168	01.01	04.05					
	330 i	170	09.00	02.05					
	330 i Touring	170	06.00	07.05					
	330 xd		10.99	02.05					
	330 xd Touring		03.00	07.05					
	330 xi	170	09.00	02.05					
	330 xi Touring	170	09.00	07.05					
	M3 Convertible	252	05.01	12.06	G1020367		21487 17,3 +/WD	ATE	
	M3 Coupe	252	06.00	08.06					
	M3 CSL Coupe	265	05.03	08.06					
	316 i		12.98	02.05	G2110202		280 10,0 8,4 L +S +C		
	316 i 1.9	77	12.98	02.05					- authority cars <sup>1)</sup>
	316 i Coupe		04.00	08.06					
	316 ti Compact	85	07.01	02.05					
	318 i		04.98	02.05					+ engine code M43 <sup>3)</sup>
	318 i Coupe		08.99	08.06					+ engine code M43 <sup>3)</sup>
	316 i 1.9	77	12.98	02.05					+ authority cars <sup>2)</sup>
	316 i Touring	85	03.02	07.05					
	318 Ci Convertible	105	09.01	12.06					
	318 Ci Convertible	110	02.05	12.06					
318 d	85	09.01	02.05						
318 d Touring	85	03.02	07.05	- authority cars <sup>1)</sup>					
318 i		04.98	02.05	- authority cars/+engine co.N42/N46 <sup>4)</sup>					
318 i Coupe		08.99	08.06	+ engine code N42/N46 <sup>5)</sup>					
318 i Touring		10.99	07.05	- authority cars <sup>1)</sup>					
318 td Compact		03.03	02.05						
318 ti Compact		09.01	02.05						
320 Ci Coupe		06.99	08.06						
320 d	100	04.98	09.01						
320 d Touring		03.00	08.01	- authority cars <sup>1)</sup>					
320 i	110	04.98	09.00	- authority cars <sup>1)</sup>					
320 i	125	09.00	02.05	- authority cars <sup>1)</sup>					
320 i Touring		10.99	07.05	- authority cars/+engine co.M52 <sup>6)</sup>					
323 Ci Coupe	125	04.99	08.00						
323 i	125	04.98	08.00	- authority cars <sup>1)</sup>					
	325 Ci Convertible	141	10.00	12.06	G2119108		294 18,9 17,4 V L +S +C		
	318 d Touring	85	03.02	07.05					+ authority cars <sup>2)</sup>
	318 i		04.98	02.05					+ authority cars <sup>2)</sup>
	318 i Touring		10.99	07.05					+ authority cars <sup>2)</sup>
	320 Cd Convertible	110	02.05	12.06					
	320 Cd Coupe	110	11.03	08.06					
	320 Ci Convertible	125	10.00	12.06					
	320 d	110	09.01	02.05					
	320 d Touring		03.00	07.05					+ authority cars <sup>2)</sup>
	320 d Touring		09.01	07.05					- authority cars <sup>1)</sup>
	320 i	110	04.98	09.00					+ authority cars <sup>2)</sup>
	320 i	125	09.00	02.05					+ authority cars <sup>2)</sup>
	320 i Touring		10.99	07.05					+ engine code M54 <sup>7)</sup>
	320 i Touring		10.99	07.05					+ authority cars/+engine no.M52 <sup>8)</sup>
	320 td Compact		09.01	02.05					
	323 Ci Convertible	125	05.00	08.00					
	323 i	125	04.98	08.00					+ authority cars <sup>2)</sup>
	325 Ci Coupe	141	10.00	08.06					
	325 i	141	10.00	02.05					
	325 i Touring	141	10.00	07.05					
	325 ti Compact	141	07.01	02.05					
	328 Ci Coupe	142	04.99	06.00					
	328 i	142	04.98	06.00					
	328 i Touring	142	10.99	06.00					

<sup>1)</sup> - enti statali / - véhicule communal / - vehiculos oficiales / - Behörde

<sup>2)</sup> + enti statali / + véhicule communal / + vehiculos oficiales / + Behörde

<sup>3)</sup> + codice motore M43 / + moteur code M43 / + motor code M43 / + Motorcode M43

<sup>4)</sup> - enti statali/+codice mot.N42/N46 / - véhicule communal/+moteur co.N42/N46 / - vehiculos oficiales/+motor co.N42/N46 / - Behörde / + Motorcode N42/N46

<sup>5)</sup> + codice motore N42/N46 / + moteur code N42/N46 / + motor code N42/N46 / + Motorcode N42/N46

<sup>6)</sup> - enti statali/+codice mot.M52 / - véhicule communal/+moteur co.M52 / - vehiculos oficiales/+motor co.M52 / - Behörde/ + Motorcode M52

<sup>7)</sup> + codice motore M54 / + moteur code M54 / + motor code M54 / + Motorcode M54

<sup>8)</sup> + enti statali/+codice mot.M52 / + véhicule communal/+moteur co.M52 / + vehiculos oficiales/+motor co.M52 / + Behörde/ + Motorcode M52









**BMW 3 series/E90 Saloon (05-12)**

	330 i 335 xi	200 225		03.10 03.10	03.12 03.12		G1020971 G1020939		24161 20,3 +/WD 23313 20,3 +/WD	ATE ATE
	M3	309		12.07	03.12		G1020634		23312 20,3 +/WD	ATE
	316 i 318 d 318 i 320 i	85 90 95		01.05 09.05 09.05	08.07 08.07 08.07	- increased payload 1) - increased payl./+engine co.N46 2) - increased payl./+engine co.N46 2)	G2122238		292 22,0 20,4 V L +S +C	
	316 d 316 i 318 d 318 d 318 i 318 i 318 i 320 d 320 d 320 i 320 i 320 i 320 si 325 i 325 xi	85 90 90 95 95 105 110 120		07.09 09.07 09.07 09.05 09.05 09.07 09.05 12.04 03.07 12.04 09.07 06.06 12.04 01.05	03.12 03.12 03.12 08.07 08.07 03.12 08.07 08.07 08.07 08.07 08.07 08.07 03.12 08.07 08.07	- increased payload 3) - increased payl./+engine co.N46N 4) + increased payl./+engine co.N46 5) - authority cars 6) - authority cars 6) - increased payl./+engine co.N46N 4) + increased payl./+engine co.N46 5) - increased payload 1) - increased payl./+engine co.N52 7) - increased payl./+engine co.N52 7)	G2124197		300 24,0 22,4 V L +S +C	
	316 d 316 i 316 i 318 d 318 i 320 i	85 85 90 90 95		07.09 01.05 09.07 09.05 09.05 12.04	02.10 08.07 02.10 08.07 08.07 08.07	- increased payload 1) - increased payl./+engine co.N46 2) - increased payl./+engine co.N46 2)	G1020844		23623 17,4 +/WD/Acc/S	LUC
	316 d 316 i	85 90		03.10 03.10	03.12 03.12		G1020844		23623 17,4 +/WD/Acc/S	LUC
	318 d 318 d 318 i 318 i 318 i 320 d 320 d 320 d 320 i 320 i 320 i 320 si 320 xd 325 i 325 xi	90 95 95 105 110 120 130		09.07 09.05 03.07 09.05 09.07 09.05 12.04 09.07 03.07 12.04 09.07 06.06 09.07 12.04 01.05	02.10 08.07 08.07 08.07 02.10 02.10 08.07 02.10 02.10 08.07 02.10 02.10 02.10 02.10 02.10 02.10	+ increased payload 3) + engine code N46N 6) + increased payl./+engine co.N46 5) - authority cars 6) - authority cars 6) + engine code N46N 6) + increased payl./+engine co.N46 5) - authority cars 6) - increased payload 1) - increased payload 1)	G1020850		23926 17,3 +/WD	ATE
	318 d 318 i 320 d 320 d 320 i 320 si 320 xd 325 i 325 xi	105 110 130 125 127		03.10 03.10 03.10 03.10 03.10 03.10 03.10	03.12 03.12 03.12 03.12 03.12 03.12 03.12	- authority cars 6) - authority cars 6) - authority cars 6) - authority cars 6) - increased payload 1) - increased payload 1)	G1020850		23926 17,3 +/WD	ATE
	320 d 320 d 320 xd 325 d 325 i 325 xi 330 d 330 d 330 i 330 i 330 xd 330 xd 330 xi 330 xi 333 d 335 i 335 xi	110 130 145 160 160 170 180 190 200 170 180 190 200 210 225 225		09.05 09.07 09.07 09.06 12.04 01.05 09.05 09.08 12.04 09.07 09.05 01.09 01.05 09.07 09.06 09.06 03.07	02.10 02.10 02.10 02.10 02.10 02.10 02.10 02.10 08.07 02.10 02.10 02.10 08.07 02.10 02.10 02.10	+ authority cars 9) + authority cars 9) + authority cars 9) + increased payload 3) + increased payload 3)	G1020887		23550 17,3 +/WD	ATE
	320 d 320 d 320 xd 325 d 325 i 325 xi 330 d 330 d 330 i 330 i 330 xd 330 xd 330 xi 335 d 335 i 335 xi	110 130 145 160 160 170 180 190 200 170 180 190 200 210 225 225		03.10 03.10 03.10 03.10 03.10 03.10 03.10 03.10 03.10 03.10 03.10 03.10 03.10 03.10 03.10 03.10	03.12 03.12 03.12 03.12 03.12 03.12 03.12 03.12 03.12 03.12 03.12 03.12 03.12 03.12 03.12 03.12	+ authority cars 9) + authority cars 9) + authority cars 9) + increased payload 3) + increased payload 3)	G1020887		23550 17,3 +/WD	ATE

1) - carico utile maggiorato / - charge utile augmentée / - incremento de carga / - erhöhte Zuladung  
 2) - carico utile maggior./+codic.mot.N46 / - charge utile augmentée/+moteur co.N46 / - incremento de carga/+motor co.N46 / - erhöhte Zuladung/+ Motorcode N46  
 3) + carico utile maggiorato / + charge utile augmentée / + incremento de carga / + erhöhte Zuladung  
 4) - carico utile maggior./+codic.mot.N46N / - charge utile augmentée/+moteur co.N46N / - incremento de carga/+motor co.N46N / - erhöhte Zuladung/+ Motorcode N46N  
 5) + carico utile maggior./+codic.mot.N46 / + charge utile augmentée/+moteur co.N46 / + incremento de carga/+motor co.N46 / + erhöhte Zuladung/+ Motorcode N46  
 6) - enti statali / - véhicule communal / - vehiculos oficiales / - Behörde  
 7) - carico utile maggior./+codic.mot.N52 / - charge utile augmentée/+moteur co.N52 / - incremento de carga/+motor co.N52 / - erhöhte Zuladung/+ Motorcode N52  
 8) + codice motore N46N / + moteur code N46N / + motor code N46N / + Motorcode N46N  
 9) + enti statali / + véhicule communal / + vehiculos oficiales / + Behörde









### BMW 3 series/E91 Touring (05-12)

	318 i	105		09.07	09.09		G2120204		300 20,0 18,4 V L +S +C
	320 d			09.07	09.09	- authority cars <sup>1)</sup>			
	320 d	120		06.05	08.07	- authority cars <sup>1)</sup>			
	320 i			06.05	08.07				
	320 i	125		09.07	09.09				
	320 xd	130		09.07	09.09	- authority cars <sup>1)</sup>			
	323 i			06.05	09.09				
	325 i	160		06.05	09.09	- increased payload <sup>2)</sup>			
	325 xi	160		03.07	08.07	- increased payl./+engine co.N52N <sup>3)</sup>			
316 d	85		09.09	05.12		G2120195		300 20,0 18,4 V L +S +C	
316i	90		10.09	05.12					
318 d	105		10.09	05.12					
318 i	100		10.09	05.12					
318 i	105		10.09	05.12					
320 d			10.09	05.12	- authority cars <sup>1)</sup>				
320 i	125		10.09	05.12					
320 xd	130		10.09	05.12	- authority cars <sup>1)</sup>				
323 i			10.09	05.12					
325 i	155		01.12	05.12	- increased payload <sup>2)</sup>				
325 i	160		10.09	05.12	- increased payload <sup>2)</sup>				

### BMW 3 series/E92 Coupe (06-13)

	316 i	90		09.07	02.10		G1020848		23794 20,3 +/WD	ATE
	320 i	125		03.07	02.10					
	323 i			09.06	02.10					
	325 d	145		03.07	02.10					
	325 i	160		09.06	08.07	+ engine code N52N <sup>4)</sup>				
	325 i	160		09.06	02.10	+ engine code N53 <sup>5)</sup>				
	325 xi	160		09.06	08.07	+ engine code N52N <sup>4)</sup>				
	316 i	90		03.10	06.13					
	318 i	105		03.10	06.13					
	320 i	125		03.10	06.13					
	323 i			03.10	06.13					
	325 d	145		03.10	06.13					
	325 i	160		03.10	06.13	+ engine code N53 <sup>5)</sup>				
	330 i	200		09.06	02.10	+ engine code N52N <sup>4)</sup>				
	330 i	200		03.10	06.13	+ engine code N52N <sup>4)</sup>				
	320 d	130		03.07	02.10					
	320 xd	130		03.07	02.10					
	325 i	160		09.07	02.10	+ engine code N52N <sup>4)</sup>				
	325 xi	160		09.07	02.10	+ engine code N52N <sup>4)</sup>				
320 d	130		03.10	06.13		G1020939		23313 20,3 +/WD	ATE	
320 xd	130		03.10	06.13						
325 i	160		03.10	06.13	+ engine code N52N <sup>4)</sup>					
325 xi	160		03.10	06.13	+ engine code N52N <sup>4)</sup>					
325 xi	160		09.06	02.10	+ engine code N53 <sup>5)</sup>					
325 xi	160		03.10	06.13	+ engine code N53 <sup>5)</sup>					
330 xi	200		09.06	02.10						
330 xi	200		03.10	06.13						
330 d	180		09.08	02.10						
330 i	200		09.06	02.10	+ engine code N53 <sup>5)</sup>					
330 d	180		03.10	06.13						
330 i	200		03.10	06.13	+ engine code N53 <sup>5)</sup>					
330 d	170		09.06	06.13						
335 d	210		09.06	06.13						
335 i	225		09.06	06.13						
330 xd	170		09.06	02.10						
335 xi	225		09.07	02.10						
330 xd	170		03.10	06.13						
335 xi	225		03.10	06.13						
M3			03.07	06.13						
316 i	90		09.07	06.13		G2124197		300 24,0 22,4 V L +S +C		
318 i	105		03.10	06.13						
320 i	125		03.07	06.13						
323 i			09.06	06.13						
	316 i	90		09.07	02.10		G1020844		23623 17,4 +/WD/Acc/S	LUC
	316 i	90		03.10	06.13					
	320 d	130		03.07	02.10					
	320 i	125		03.07	02.10					
	320 xd	130		03.07	02.10					
	323 i			09.06	02.10					
	325 i	160		09.06	02.10					
	325 xi	160		09.06	02.10					
	318 i	105		03.10	06.13					
	320 d	130		03.10	06.13					
	320 i	125		03.10	06.13					
	320 xd	130		03.10	06.13					
	323 i			03.10	06.13					
	325 i	160		03.10	06.13					
	325 xi	160		03.10	06.13					
	325 d	145		03.07	02.10					
	330 d	170		09.06	02.10					
330 d	180		09.08	02.10						

<sup>1)</sup> - enti statali / - véhicules communal / - vehiculos oficiales / - Behörde

<sup>2)</sup> - carico utile maggiorato / - charge utile augmentée / - incremento de carga / - erhöhte Zuladung

<sup>3)</sup> - carico utile maggior./+codic.mot.N52N / - charge utile augmentée/+moteur co.N52N / - incremento de carga/+motor co.N52N / - erhöhte Zuladung/+ Motorcode N52N

<sup>4)</sup> + codice motore N52N / + moteur code N52N / + motor code N52N / + Motorcode N52N

<sup>5)</sup> + codice motore N53 / + moteur code N53 / + motor code N53 / + Motorcode N53



### BMW 3 series/E92 Coupe (06-13)

	330 i	200		09.06	02.10	G1020887		23550 17,3 +/WD	ATE				
	330 xd	170		09.06	02.10								
	330 xi	200		09.06	02.10								
	335 d	210		09.06	02.10								
	335 i	225		09.06	02.10								
	335 xi	225		09.07	02.10								
	325 d	145		03.10	06.13					G1020887		23550 17,3 +/WD	ATE
	330 d	170		03.10	06.13								
	330 d	180		03.10	06.13								
	330 i	200		03.10	06.13								
	330 xd	170		03.10	06.13								
	330 xi	200		03.10	06.13								
335 d	210		03.10	06.13									
335 i	225		03.10	06.13									
335 xi	225		03.10	06.13									
M3			03.07	02.10	G1020638		23309 17,3 +/WD	ATE					
M3			03.10	06.13					G1020638				
	318 i	105		03.10	06.13	G2120195		300 20,0 18,4 V L +S +C					
	320 d	130		03.07	06.13								
	320 i	125		03.07	06.13								
	323 i			09.06	06.13								
	325 i	160		09.06	06.13								
	320 xd	130		03.07	06.13					G2120204		300 20,0 18,4 V L +S +C	
	325 xi	160		09.06	06.13								

### BMW 3 series/E93 Convertible (07-)

	320 d	120		01.08	02.10	G1020939		23313 20,3 +/WD	ATE				
	320 d	130		03.08	02.10								
	320 i			03.07	02.08								
	323 i	130		03.07	02.10								
	325 i	160		03.07	02.10 + engine code N52N <sup>1)</sup>								
	320 d	120		03.10						G1020939		23313 20,3 +/WD	ATE
	320 d	130		03.10									
	323 i	130		03.10									
	325 i	160		03.10	+ engine code N52N <sup>1)</sup>								
	320 i			03.08	02.10					G1020848		23794 20,3 +/WD	ATE
	325 d	145		09.07	02.10								
	325 i	160		03.07	02.10 + engine code N53 <sup>2)</sup>								
330 i	200		03.07	02.10 + engine code N52N <sup>1)</sup>									
318 i	105		03.10		G1020848		23794 20,3 +/WD	ATE					
320 i			03.10										
325 d	145		03.10										
325 d	150		03.10										
325 i	160		03.10	+ engine code N53 <sup>2)</sup>									
330 i	200		03.10	+ engine code N52N <sup>1)</sup>									
330 d	170		03.10	- increased payload <sup>3)</sup>	G1020848		23794 20,3 +/WD	ATE					
330 i	200		03.10	- increased payl./+engine co.N53 <sup>4)</sup>									
330 i	200		03.07	02.10 + engine code N53 <sup>2)</sup>	G1020971		24161 20,3 +/WD	ATE					
									G1020939	23313 20,3 +/WD	ATE		
	330 d	170	03.07	02.10	G1020971		24161 20,3 +/WD	ATE					
	335 i	225	03.07	02.10					G1020939	23313 20,3 +/WD	ATE		
	330 d	170	03.10		G1020971		24161 20,3 +/WD	ATE					
	330 i	200	03.10	+ increased payload <sup>5)</sup>					G1020939	23313 20,3 +/WD	ATE		
	335 i	225	03.10	+ increased payl./+engine co.N53 <sup>6)</sup>									
	M3	309	03.08		G1020634		23312 20,3 +/WD	ATE					
	318 i	105		03.10		G2124197		300 20,0 22,4 V L +S +C					
	320 i			03.08									
	320 d	120		01.08	02.10	G1020850		23926 17,3 +/WD	ATE				
	320 d	130		03.08	02.10								
	320 i			03.07	02.10								
	323 i	130		03.07	02.10								
	325 i	160		03.07	02.10								
	318 i	105		03.10						G1020850		23926 17,3 +/WD	ATE
	320 d	120		03.10									
	320 d	130		03.10									
	320 i			03.10									
	325 i	160		03.10									
	325 d	145		09.07	02.10								
	330 d	170		03.07	02.10								
330 i	200		03.07	02.10									
335 i	225		03.07	02.10									
	325 d	145		03.10	G1020887		23550 17,3 +/WD	ATE					
	325 d	150		03.10									
	330 d	170		03.10									
	330 i	200		03.10									
	335 i	225		03.10									
	M3	309		03.08					G1020638		23309 17,3 +/WD	ATE	
	M3	309		03.10									G1020638
	320 d	120		01.08						G2120204		300 20,0 18,4 V L +S +C	
	320 d	130		03.08									
	320 i			03.07	08.09								
	323 i	130		03.07									
	325 i	160		03.07									

<sup>1)</sup> + codice motore N52N / + moteur code N52N / + motor code N52N / + Motorcode N52N

<sup>2)</sup> + codice motore N53 / + moteur code N53 / + motor code N53 / + Motorcode N53

<sup>3)</sup> - carico utile maggiorato / - charge utile augmentée / - incremento de carga / - erhöhte Zuladung

<sup>4)</sup> - carico utile maggior./+codic.mot.N53 / - charge utile augmentée/+ moteur co.N53 / - incremento de carga/+motor co.N53 / - erhöhte Zuladung/ + Motorcode N53

<sup>5)</sup> + carico utile maggiorato / + charge utile augmentée / + incremento de carga / + erhöhte Zuladung



<sup>6)</sup> + carico utile maggior./+codic.mot.N53 / + charge utile augmentée/+moteur co.N53 / + incremento de carga/+motor co.N53 / + erhöhte Zuladung/ + Motorcode N53



### BMW 3 series/E93 Convertible (07-)

	318 i 320 i	105		03.10 09.09		G2120195		300 20,0 18,4 V L +S +C
--	----------------	-----	--	----------------	--	----------	--	-------------------------

### BMW 5 series/E34 (88-96)

	518 i 518 i Touring 520 i 520 i 24V 520 i Touring 524 td 525 i 525 i 24V 525 i Touring 525 td 525 td Touring 525 tds 525 tds Touring 530 i 530 i V8 530 i V8 Touring 535 i 540 i Touring 540 i V8 M5 3.6 M5 3.8			04.89 03.93 01.88 03.89 11.91 03.88 01.88 09.89 11.91 04.93 03.93 09.91 12.91 01.88 03.92 05.92 01.88 05.93 03.92 10.88 03.92	09.95 11.96 09.90 09.95 11.96 08.91 09.90 09.95 11.96 09.95 11.96 09.95 11.96 09.95 09.95 11.96 09.95 09.95 11.96 09.95 09.95 05.94		G1020474		20968 20,3 +/WD	ATE
	525 ix 525 ix Touring	141 141		04.91 02.92	09.95 11.96		G1020474		20968 20,3 +/WD	ATE
	518 i 518 i Touring 520 i 520 i 24V 520 i Touring 524 td 525 i 525 i 24V 525 i Touring 525 ix 525 ix Touring 525 td 525 td Touring 525 tds 525 tds Touring 530 i 530 i V8 530 i V8 Touring 535 i 540 i Touring 540 i V8 M5 3.6 M5 3.8			04.89 03.93 01.88 03.89 11.91 03.88 01.88 09.89 11.91 04.91 02.92 04.93 03.93 09.91 12.91 01.88 03.92 05.92 01.88 05.93 03.92 10.88 03.92	+ ABS 11.96 09.90 09.95 11.96 08.91 09.90 09.95 11.96 09.95 11.96 09.95 11.96 09.95 11.96 09.95 09.95 11.96 09.95 09.95 11.96 09.95 05.94		G1020308		20995 17,1 +/WD	ATE

### BMW 5 series/E39 (96-03)

	520 d 520 d Touring 520 i 520 i Touring 523 i 523 i Touring 525 d 525 d Touring 525 i 525 i Touring 525 td 525 tds 525 tds Touring 528 i 528 i Touring 530 d 530 d Touring 535 i	100 100 100 125 125 120 120 141 141 85 105 105 142 142 142 09.98 09.98 05.96		04.00 04.00 03.96 05.97 12.95 05.97 04.00 04.00 10.00 10.00 01.97 02.96 06.98 12.95 05.97 09.98 09.98 05.96	07.03 07.03 07.03 07.03 09.00 09.00 07.03 07.03 07.03 07.03 09.00 09.00 09.00 09.00 09.00 09.00 09.00 09.00 08.97		G1020411		21677 20,3 +/WD	ATE	
	520 d 520 d Touring 520 i 520 i Touring 525 d 525 d Touring 525 i 525 i Touring 530 d 530 d Touring 530 i 530 i Touring 540 i 540 i Touring 535 i	100 100 120 120 141 141 170 170 210 210		04.00 04.00 03.96 05.97 04.00 04.00 10.00 10.00 10.00 10.00 10.00 05.96 05.97 09.97	07.03 07.03 07.03 07.03 07.03 07.03 07.03 07.03 07.03 07.03 07.03 07.03 07.03 07.03	+ authority cars <sup>2)</sup> + authority cars <sup>2)</sup> + authority cars <sup>2)</sup> + authority cars <sup>2)</sup> + authority cars <sup>2)</sup> + authority cars <sup>2)</sup> + authority cars <sup>2)</sup> + authority cars <sup>2)</sup> + authority cars <sup>2)</sup> + authority cars <sup>2)</sup> + authority cars <sup>2)</sup> + authority cars <sup>2)</sup> + authority cars <sup>2)</sup> + authority cars <sup>2)</sup>		G1020368		21486 19,3 +/WD	ATE
	535 i			09.97	07.03		G1020368		21486 19,3 +/WD	ATE	

1) - enti statali / - véhicule communal / - vehiculos oficiales / - Behörde  
2) + enti statali / + véhicule communal / + vehiculos oficiales / + Behörde



### BMW 5 series/E39 (96-03)

	M5	294		10.98	07.03	(USA)	G1020368		21486	19,3 +/WD	ATE
	520 d	100		04.00	07.03	- authority cars <sup>1)</sup>	G2122159		296	22,0 20,4 V L +S +C	
	520 d Touring	100		04.00	07.03	- authority cars <sup>1)</sup>					
	520 i			03.96	07.03	- authority cars <sup>1)</sup>					
	520 i Touring			05.97	07.03	- authority cars <sup>1)</sup>					
	523 i	125		12.95	09.00						
	523 i Touring	125		05.97	09.00						
	525 d	120		04.00	07.03	- authority cars <sup>1)</sup>					
	525 d Touring	120		04.00	07.03	- authority cars <sup>1)</sup>					
	525 i	141		10.00	07.03	- authority cars <sup>1)</sup>					
	525 i Touring	141		10.00	07.03	- authority cars <sup>1)</sup>					
	525 td	85		01.97	09.00						
	525 tds	105		02.96	09.00						
	525 tds Touring	105		06.98	09.00						
	528 i	142		12.95	09.00						
	528 i Touring	142		05.97	09.00						
	530 d			09.98	09.00						
	530 d Touring			09.98	09.00						
	535 i			05.96	08.97						
	520 d	100		04.00	07.03		G1020415		21691	17,1 +/WD	ATE
	520 i			03.96	07.03						
	523 i	125		12.95	09.00						
	525 d	120		04.00	07.03						
	525 i	141		10.00	07.03						
	525 td	85		01.97	09.00						
	525 tds	105		02.96	09.00						
	528 i	142		12.95	09.00						
	530 d			09.98	07.03						
	530 i	170		10.00	07.03						
	535 i			05.96	07.03						
	540 i	210		05.96	07.03						
	520 d Touring	100		04.00	07.03						
	520 i Touring			05.97	07.03						
	523 i Touring	125		05.97	09.00						
	525 d Touring	120		04.00	07.03						
	525 i Touring	141		10.00	07.03						
	525 tds Touring	105		06.98	09.00						
	528 i Touring	142		05.97	09.00						
	530 d Touring			09.98	07.03						
	530 i Touring	170		10.00	07.03						
	540 i Touring	210		05.97	07.03						
	M5	294		10.98	07.03		G1020367		21487	17,3 +/WD	ATE

### BMW 5 series/E60 Saloon (03-10)

	520 d			07.05	02.10	- authority cars <sup>1)</sup>	G1020586		23794	20,3 +/WD	ATE
	520 i			07.03	03.05	+ manual transmission <sup>2)</sup>					
	523 i	130		07.05	03.07	- authority cars <sup>1)</sup>					
	523 i	140		03.07	02.10	- authority cars/+engine co. N52N <sup>3)</sup>					
	525 d			10.03	03.07	- authority cars <sup>1)</sup>					
	525 i	141		07.03	06.05	- authority cars <sup>1)</sup>					
	525 i	160		03.07	02.10	- authority cars/+engine co. N52N <sup>3)</sup>					
	520 d			07.05	02.10	+ authority cars <sup>4)</sup>	G1020634		23312	20,3 +/WD	ATE
	520 d	130		09.07	02.10						
	520 i			07.03	03.05	+ autom.transmission <sup>5)</sup>					
	523 i	130		07.05	03.07	+ authority cars <sup>4)</sup>					
	523 i	140		03.07	02.10	+ engine code N53 <sup>6)</sup>					
	523 i	140		03.07	02.10	+ authority cars/+engine no.N52N <sup>7)</sup>					
	525 d			10.03	03.07	+ authority cars <sup>4)</sup>					
	525 d	145		03.07	02.10						
	525 i	141		07.03	06.05	+ authority cars <sup>4)</sup>					
	525 i	160		03.07	02.10	+ engine code N53 <sup>6)</sup>					
	525 i	160		03.07	02.10	+ authority cars/+engine no.N52N <sup>7)</sup>					
	525 i	160		07.05	03.07						
	525 xd	145		03.07	02.10						
	525 xi	160		07.05	02.10						
	530 d	160		07.03	08.05						
	530 d	170		07.03	03.07						
	530 d	173		03.07	02.10						
	530 i	170		07.03	03.05						
	530 i	190		07.05	03.07						
	530 i	200		01.07	02.10						
	530 xd	170		07.05	03.07						
	530 xd	173		03.07	02.10						
	530 xi	190		07.05	03.07						
	530 xi	200		03.07	02.10						
	530 d	160		07.03	08.05		G1020634		23312	20,3 +/WD	ATE
	530 d	170		07.03	03.07						
	530 d	173		03.07	02.10						
	530 i	170		07.03	03.05						
	530 i	190		07.05	03.07						
	530 i	200		01.07	02.10						
	530 xd	170		07.05	03.07						
	530 xd	173		03.07	02.10						
	530 xi	190		07.05	03.07						
	530 xi	200		07.05	03.07						

<sup>1)</sup> - enti statali / - vehicule communal / - vehiculos oficiales / - Behörde

<sup>2)</sup> + scatola cambio velocità / + transmission mécanique / + cambio de velocidad / + Schaltgetriebe

<sup>3)</sup> - enti statali/+codice mot.N52N / - vehicule communal/+moteur co.N52N / - vehiculos oficiales/+motor co.N52N / - Behörde/ + Motorcode N52N

<sup>4)</sup> + enti statali / + vehicule communal / + vehiculos oficiales / + Behörde

<sup>5)</sup> + scatola cambio automatico / + transmission automatique / + cambio automático / + Automatikgetriebe

<sup>6)</sup> + codice motore N53 / + moteur code N53 / + motor code N53 / + Motorcode N53

<sup>7)</sup> + enti statali/+codice mot.N52N / + vehicule communal/+moteur co.N52N / + vehiculos oficiales/+motor co.N52N / + Behörde/ + Motorcode N52N







**BMW 5 series/E60 Saloon (03-10)**

	530 xi	200		03.07	02.10		G1020634		23312 20,3 +/WD	ATE		
	540 i	225		03.07	02.10	- increased payload 1)	G1020634		23312 20,3 +/WD	ATE		
	540 i	225		07.05	03.07							
	545 i	245		07.03	08.05							
	550 i	270		03.07	02.10	+ USA						
	535 d	200		09.04	03.07		G1020746		23791 20,8 +/WD	ATE		
	535 d	210		03.07	02.10							
	540 i	225		03.07	02.10	+ increased payload 2)						
	550 i	270		03.07	02.10	- USA	G1020746		23791 20,8 +/WD	ATE		
	550 i	270		07.05	03.07							
	M5	373		09.04	02.10							
	520 d	130		07.05	02.10		G1020588		23732 17,3 +/WD	ATE		
	520 d	130		09.07	02.10							
	520 i	130		07.03	03.05							
	523 i	130		07.05	03.07							
	523 i	140		03.07	02.10							
	525 d	145		10.03	03.07							
	525 d	145		03.07	02.10	- authority cars 3)						
	525 i	141		07.03	06.05							
	525 i	160		03.07	02.10	- authority cars/+engine co.N53 4)						
	525 i	160		03.07	02.10	+ engine code N52N 5)						
	525 i	160		07.05	03.07							
	525 xd	145		03.07	02.10							
	525 xi	160		07.05	02.10							
	530 d	160		07.03	08.05	- authority cars 3)						
	530 d	170		07.03	03.07	- authority cars 3)						
	530 d	173		03.07	02.10	- authority cars 3)						
	530 i	170		07.03	03.05							
	530 i	190		07.05	03.07	- authority cars 3)						
	530 i	200		01.07	02.10	- authority cars/+engine co. N52N 6)						
	530 xd	170		07.05	03.07							
	530 xd	173		03.07	02.10							
	530 xi	190		07.05	03.07							
	530 xi	200		03.07	02.10							
	525 d	145		03.07	02.10	+ authority cars 7)	G1020638				23309 17,3 +/WD	ATE
	525 i	160		03.07	02.10	+ authority cars/+engine no.N53 8)						
	530 d	160		07.03	08.05	+ authority cars 7)						
	530 d	170		07.03	03.07	+ authority cars 7)						
530 d	173		03.07	02.10	+ authority cars 7)							
530 i	190		07.05	03.07	+ authority cars 7)							
530 i	200		01.07	02.10	+ engine code N53 9)							
530 i	200		01.07	02.10	+ authority cars/+engine no.N52N 10)							
535 d	200		09.04	03.07								
535 d	210		03.07	02.10								
540 i	225		07.05	02.10								
545 i	245		07.03	08.05								
550 i	270		07.05	02.10								
M5	373		09.04	02.10								















**BMW 5 series/E61 Touring (04-10)**

	520 d	110		09.05	05.10	- authority cars 3)	G1020586		23794 20,3 +/WD	ATE		
	520 d	120		07.05	05.10	- authority cars 3)						
	520 i	125		06.04	05.10	- authority cars 3)						
	523 i	130		07.05	03.07	- authority cars 3)						
	523 i	140		03.07	05.10	- authority cars/+engine co. N52N 6)						
	525 d	120		12.04	05.10							
	525 d	130		05.04	03.07	- authority cars 3)						
	525 i	141		05.04	03.05	- authority cars 3)						
	525 i	160		03.07	05.10	- authority cars/+engine co. N52N 6)						
	520 d	110		09.05	05.10	+ authority cars 7)	G1020634				23312 20,3 +/WD	ATE
	520 d	120		07.05	05.10	+ authority cars 7)						
	520 d	130		09.07	05.10							
	520 i	125		06.04	05.10	+ authority cars 7)						
	523 i	130		07.05	03.07	+ authority cars 7)						
523 i	140		03.07	05.10	+ engine code N53 9)							
523 i	140		03.07	05.10	+ authority cars/+engine no.N52N 10)							
525 d	120		12.04	05.10								
525 d	130		05.04	03.07	+ authority cars 7)							
525 d	145		03.07	05.10								
525 i	141		05.04	03.05	+ authority cars 7)							
525 i	160		03.07	05.10	+ engine code N53 9)							
525 i	160		03.07	05.10	+ authority cars/+engine no.N52N 10)							
525 i	160		07.05	03.07								
525 xd	145		03.07	05.10								
525 xi	160		07.05	05.10								
530 d	160		05.04	08.05								
530 d	170		07.05	03.07								
530 d	173		03.07	05.10								
530 i	190		07.05	03.07								
530 i	200		03.07	05.10								
530 xd	170		07.05	03.07								
530 xd	173		03.07	05.10								
530 xi	190		07.05	03.07								
530 xi	200		03.07	05.10								
545 i	245		05.04	08.05		G1020634		23312 20,3 +/WD	ATE			
550 i	270		03.07	05.10	+ USA							













1) - carico utile maggiorato / - charge utile augmentée / - incremento de carga / - erhöhte Zuladung  
2) + carico utile maggiorato / + charge utile augmentée / + incremento de carga / + erhöhte Zuladung  
3) - enti statali / - véhicule communal / - vehiculos oficiales / - Behörde  
4) - enti statali/codice mot.N53 / - véhicule communal/moteur co.N53 / - vehiculos oficiales/motor co.N53 / - Behörde/ + Motorcode N53  
5) + codice motore N52N / + moteur code N52N / + motor code N52N / + Motorcode N52N  
6) - enti statali/codice mot.N52N / - véhicule communal/moteur co.N52N / - vehiculos oficiales/motor co.N52N / - Behörde/ + Motorcode N52N

7) + enti statali / + véhicule communal / + vehiculos oficiales / + Behörde  
8) + enti statali/codice mot.N53 / + véhicule communal/moteur co.N53 / + vehiculos oficiales/motor co.N53 / + Behörde/ + Motorcode N53  
9) + codice motore N53 / + moteur code N53 / + motor code N53 / + Motorcode N53  
10) + enti statali/codice mot.N52N / + véhicule communal/moteur co.N52N / + vehiculos oficiales/motor co.N52N / + Behörde/ + Motorcode N52N



									
<b>BMW 7 series/E32 (86-94)</b>									
	730 i 6	160		07.86	06.94		G1020308	20995 17,1 +/WD	ATE
	730 i 8			03.91	06.94				
	730 iL 6			12.87	06.94				
	730 iL 8	160		06.92	06.94				
	735 i			09.86	09.92				
	735 iL			09.86	09.92				
	740 i	210		09.91	06.94				
	740 iL	210		10.91	06.94				
	750 i	220		07.87	06.94				
	750 iL	220		11.86	06.94				
<b>BMW 7 series/E38 (93-01)</b>									
	725 tds	105		05.96	11.01		G1020372	21471 18,0 /WD	BRE
	728 i	142		07.95	11.01				
	728 iL	142		01.96	11.01				
	730 d			09.98	11.01				
	730 i			07.93	11.01				
	730 iL			05.94	11.01				
	735 i	173		01.96	11.01				
	735 iL	173		01.96	11.01				
	740 i	210		07.93	11.01		G1020368	21486 19,3 +/WD	ATE
	740 iL	210		05.94	11.01				
	750 i	240		11.93	08.98		G1020683	21484 20,5 +/WD	ATE
	750 iL	240		01.94	08.98				
	740 d	180		05.99	11.01		G1020683	21484 20,5 +/WD	ATE
	750 i	240		09.98	11.01				
	750 iL	240		09.98	11.01				
	725 tds	105		05.96	11.01		G1020367	21487 17,3 +/WD	ATE
	728 i	142		07.95	11.01				
	728 iL	142		01.96	11.01				
	730 d			09.98	11.01				
	730 i			07.93	11.01				
	730 iL			05.94	11.01				
	735 i	173		01.96	11.01				
	735 iL	173		01.96	11.01				
	740 d	180		05.99	11.01				
	740 i	210		07.93	11.01				
	740 iL	210		05.94	11.01				
	750 i	240		11.93	11.01				
	750 iL	240		01.94	11.01				
<b>BMW 7 series/E65-66 (02-08)</b>									
	730 d			09.02	08.08		G1020634	23312 20,3 +/WD	ATE
	730 i	170		03.03	08.08				
	730 i, Li	190		07.05	08.08				
	730 Ld	170		03.05	08.08				
	730 Li	170		03.03	08.08				
	730 Li	170		03.03	08.08				
	735 i	200		11.01	08.08		G1020634	23312 20,3 +/WD	ATE
	735 Li	200		04.02	08.08				
	740 d	190		09.02	08.08				
	740 i, Li	225		03.05	08.08		G1020634	23312 20,3 +/WD	ATE
	745 i	245		11.01	08.08				
	745 Li	245		04.02	08.08				
	750 i	270		03.05	08.08	- Europe <sup>1)</sup>			
	750 Li	270		03.05	08.08	- Europe <sup>1)</sup>			
	760 i	327		03.03	08.08	- Europe <sup>1)</sup>			
	760 Li	327		03.03	08.08	- Europe <sup>1)</sup>			
	745 d			03.05	08.08		G1020746	23791 20,8 +/WD	ATE
	750 i	270		03.05	08.08	+ Europe <sup>2)</sup>			
	750 Li	270		03.05	08.08	+ Europe <sup>2)</sup>			
	760 i	327		03.03	08.08	+ Europe <sup>2)</sup>			
	760 Li	327		03.03	08.08	+ Europe <sup>2)</sup>			
	730 d			09.02	02.05		G1020637	23447 17,3 +/WD	ATE
	730 i	170		03.03	08.08				
	730 i, Li	190		07.05	08.08				
	730 Li	170		03.03	08.08				
	735 i	200		11.01	08.08				
	735 Li	200		04.02	08.08				
	730 d			03.05	08.08		G1020638	23309 17,3 +/WD	ATE
	730 Ld	170		03.05	08.08				
	740 d	190		09.02	08.08				
	740 i, Li	225		03.05	08.08				
	745 d			03.05	08.08				
	745 i	245		11.01	08.08				
	745 Li	245		04.02	08.08				
	750 i	270		03.05	08.08				
	750 Li	270		03.05	08.08				
	760 i	327		03.03	08.08				
	760 Li	327		03.03	08.08				

<sup>1)</sup> - Europa / - Europe / - Europa / - Europa  
<sup>2)</sup> + Europa / + Europe / + Europa / + Europa





















									
<b>BMW X1 (09-)</b>									
	sDrive 18 d	105		10.09	02.10	G1020939	23313 20,3 +/WD	ATE	
	sDrive 20 d	130		10.09	02.10				
	xDrive 18 d	105		10.09	02.10	G1020939	23313 20,3 +/WD	ATE	
	xDrive 20 d	130		10.09	02.10				
	xDrive 23 d	150		10.09	02.10	G1020848	23794 20,3 +/WD	ATE	
	sDrive 16 d	85		07.12		G1020939	23313 20,3 +/WD	ATE	
	sDrive 18 d	105		03.10					
	sDrive 18 i	110		03.10					
	sDrive 20 d	130		03.10					
	sDrive 20 d	135		07.12					
	sDrive 20 d ed	120		03.10					
	sDrive 20 i	135		09.11					
	xDrive 18 d	105		03.10		G1020939	23313 20,3 +/WD	ATE	
	xDrive 20 d	130		03.10					
	xDrive 20 d	135		07.12					
	xDrive 20 i	135		09.11					
	xDrive 23 d	150		03.12					
	xDrive 25 d	160		07.12					
xDrive 25 i	160		03.12						
xDrive 28 i	180		03.12						
xDrive 23 d	150		03.10	02.12	G1020848	23794 20,3 +/WD	ATE		
xDrive 25 i	160		03.10	02.12					
xDrive 28 i	180		04.11	02.12					
xDrive 28 i	190		10.09	02.10	G1020971 G1020939	24161 20,3 +/WD 23313 20,3 +/WD	ATE ATE		
xDrive 28 i	190		03.10		G1020971 G1020939	24161 20,3 +/WD 23313 20,3 +/WD	ATE ATE		
	sDrive 18 d	105		10.09	02.10	G1020850	23926 17,3 +/WD	ATE	
	sDrive 20 d	130		10.09	02.10				
	xDrive 18 d	105		10.09	02.10				
	xDrive 20 d	130		10.09	02.10				
	xDrive 23 d	150		10.09	02.10				
	sDrive 16 d	85		07.12		G1020850	23926 17,3 +/WD	ATE	
	sDrive 18 d	105		03.10					
	sDrive 18 i	110		03.10					
	sDrive 20 d	130		03.10					
	sDrive 20 d	135		07.12					
	sDrive 20 d ed	120		03.10					
	sDrive 20 i	135		09.11					
	xDrive 18 d	105		03.10					
	xDrive 20 d	130		03.10					
	xDrive 20 d	135		07.12					
	xDrive 20 i	135		09.11					
	xDrive 23 d	150		03.10					
	xDrive 25 d	160		07.12					
xDrive 25 i	160		03.10						
xDrive 28 i	180		04.11						
xDrive 28 i	190		10.09	02.10	G1020887	23550 17,3 +/WD	ATE		
xDrive 28 i	190		03.10		G1020887	23550 17,3 +/WD	ATE		
	sDrive 16 d	85		07.12		G2120204	300 20,0 18,4 V L +S +C		
	sDrive 18 d	105		10.09					
	sDrive 18 i	110		03.10					
	sDrive 20 d	130		10.09					
	sDrive 20 d	135		07.12					
	sDrive 20 d ed	120		03.10					
	sDrive 20 i	135		09.11					
	xDrive 18 d	105		10.09					
	xDrive 20 d	130		10.09					
	xDrive 20 d	135		07.12					
	xDrive 20 i	135		09.11					
	xDrive 23 d	150		10.09					
	xDrive 25 d	160		07.12					
	xDrive 25 i	160		03.10					
	xDrive 28 i	180		04.11					
	<b>BMW X3 (03-10)</b>								
		1.8 d	105		09.08	08.10	G1020591	23183 20,3 +/WD	ATE
		2.0 d			09.07	08.10			
2.0 d		110		08.04	08.10				
2.0 i		110		07.05	08.10				
2.5 i		141		03.04	08.06				
2.5 si		160		09.06	08.10				
3.0 d				01.04	08.10				
3.0 d		150		10.03	08.06				
3.0 i		170		10.03	08.06				
3.0 si		200		09.06	08.10				
3.0 sd	210		09.06	08.10	G1020368	21486 19,3 +/WD	ATE		
	1.8 d	105		09.08	08.10	G1020367	21487 17,3 +/WD	ATE	
	2.0 d			09.07	08.10				
	2.0 d	110		08.04	08.10				
	2.0 i	110		07.05	08.10				
	2.5 i	141		03.04	08.06				
	2.5 si	160		09.06	08.10				
	3.0 d			01.04	08.10				
3.0 d	150		10.03	08.06					
↓									





















BMW X6 (08-)																
	30 d	173		11.08	02.10	G1020806			24170 20,2 +/WD	ATE						
	35 d	210		11.08	02.10											
	35 i	225		11.08	02.10											
	xDrive 30 d			11.08	02.10											
	xDrive 35 d	210		11.08	02.10											
	xDrive 35 i	225		11.08	02.10											
	30 d	173		03.10	11.10											
	35 d	210		09.10	11.10											
	35 d	210		03.10	11.10											
	35 i	225		03.10	11.10											
	xDrive 30 d			03.10	11.10											
	xDrive 35 d	210		03.10	11.10											
xDrive 35 i	225		03.10	11.10												
xDrive 40 d	225		10.10	11.10												
30 d	173		12.10													
35 d	210		12.10													
35 i	225		12.10													
xDrive 30 d			12.10													
xDrive 30 d	180		12.10													
xDrive 35 d	210		12.10													
xDrive 35 i	225		12.10													
xDrive 40 d	225		12.10													
	35 d	210		01.08	10.09	G1020638			23309 17,3 +/WD	ATE						
	35 i	225		01.08	10.09											
	50 i	300		11.09	02.10											
	xDrive 35 d	210		09.08	10.09											
	xDrive 35 i	225		09.08	10.09											
	xDrive 50 i	300		11.09	02.10											
	50 i	300		03.10												
	ActiveHybrid	357		10.10												
	xDrive 50 i	300		03.10												
	xDrive M50 d	280		06.12												
	30 d	173		09.08	02.10											
	35 d	210		11.09	02.10											
35 i	225		11.09	02.10												
xDrive 30 d			09.08	02.10												
xDrive 35 d	210		11.09	02.10												
xDrive 35 i	225		11.09	02.10												
30 d	173		03.10													
35 d	210		03.10													
35 i	225		03.10													
xDrive 30 d			03.10													
xDrive 30 d	180		09.10													
xDrive 35 d	210		03.10													
xDrive 35 i	225		03.10													
xDrive 40 d	225		10.10													
BMW Z3 (95-02)																
	1.8	85		10.95	10.98	G1020608			21643 17,8 +/WD	ATE						
	1.9			10.95	12.02											
	2.0	110		04.99	08.00											
	2.2	125		10.00	12.02											
	2.8 Coupe	141		07.97	06.00											
	2.8 Roadster	141		05.97	06.00											
	3.0 Coupe	170		06.00	12.02											
	3.0 Roadster	170		06.00	12.02											
	M Coupe			02.98	12.02											
	M Roadster			03.97	12.02											
	1.8	85		10.95	10.98	G2112126			286 12,0 10,4 +S +C							
	1.9			10.95	12.02											
	2.0	110		04.99	08.00											
	2.2	125		10.00	12.02											
	2.8 Coupe	141		07.97	06.00											
	2.8 Roadster	141		05.97	06.00											
	3.0 Coupe	170		06.00	12.02											
	3.0 Roadster	170		06.00	12.02											
		1.8	85		10.95						10.98	G1020316			20180 17,1 +/WD	ATE
		1.9			10.95						12.02					
2.0		110		04.99	08.00											
2.2		125		10.00	12.02											
2.8 Coupe		141		07.97	06.00											
2.8 Roadster		141		05.97	06.00											
3.0 Coupe		170		06.00	12.02											
3.0 Roadster		170		06.00	12.02											
M Coupe				02.98	12.02											
M Roadster				03.97	12.02											
	2.0 i	110		04.05	12.08	G1020608			21643 17,8 +/WD	ATE						
	2.2 i	125		10.03	12.08											
	2.5 i	130		01.06	12.08											
	2.5 i	141		12.02	12.08											
	2.5 si	160		01.06	12.08											
	3.0 i	170		12.02	12.08											
	3.0 i															
	3.0 si	195		01.06	12.08											
	3.0 si															
	3.0 si															
BMW Z4 Roadster/E85 (03-08)																
	2.0 i	110		04.05	12.08	G1020608			21643 17,8 +/WD	ATE						
	2.2 i	125		10.03	12.08											
	2.5 i	130		01.06	12.08											
	2.5 i	141		12.02	12.08											
	2.5 si	160		01.06	12.08											
	3.0 i	170		12.02	12.08											
	3.0 i															
	3.0 si	195		01.06	12.08											
	3.0 si															
	3.0 si															



									
<b>BMW Z4 Roadster/E85 (03-08)</b>									
	2.0 i	110		04.05	12.08		G2122115	286 22,0 20,4 V L +S +C	
	2.2 i	125		10.03	12.08				
	2.5 i	130		01.06	12.08				
	2.5 i	141		12.02	12.08				
	2.5 si	160		01.06	12.08		G2122160	300 22,0 20,4 V L +S +C	
	3.0 i	170		12.02	12.08				
	3.0 si	195		01.06	12.08		G2125138	325 24,9 23,4 V L +S +C	
	2.0 i	110		04.05	12.08		G1020316	20180 17,1 +WD ATE	
	2.2 i	125		10.03	12.08				
	2.5 i	130		01.06	12.08				
	2.5 i	141		12.02	12.08				
	2.5 si	160		01.06	12.08				
3.0 i	170		12.02	12.08					
3.0 si	195		01.06	12.08					
M 3.2	252		01.06	12.08		G1020367	21487 17,3 +WD ATE		
<b>BMW Z4 Coupe/E86 (06-08)</b>									
	3.0 si	195		03.06	09.08		G1020591	23183 20,3 +WD ATE	
	3.0 si	195		03.06	09.08		G2125138	325 24,9 23,4 V L +S +C	
	3.0 si	195		03.06	09.08		G1020316	20180 17,1 +WD ATE	
	M 3.2	252		03.06	09.08		G1020367	21487 17,3 +WD ATE	
<b>BMW Z4 Roadster/E89 (09-)</b>									
	sDrive 23i	150		01.09	02.10		G1020848	23794 20,3 +WD ATE	
	sDrive 18i	115		03.13			G1020848	23794 20,3 +WD ATE	
	sDrive 20i	135		09.11					
	sDrive 23i	150		03.10					
	sDrive 28i	180		09.11					
	sDrive 30i	190		03.10					
	sDrive 30i	190		01.09	02.10		G1020848	23794 20,3 +WD ATE	
	sDrive 35i	225		01.09	02.10		G1020971 G1020939	24161 20,3 +WD ATE 23313 20,3 +WD ATE	
	sDrive 35i	225		03.10			G1020971	24161 20,3 +WD ATE	
	sDrive 35is	250		09.10			G1020939	23313 20,3 +WD ATE	
	sDrive 18i	115		03.13			G2124197	300 24,0 22,4 V L +S +C	
	sDrive 20i	135		09.11					
	sDrive 23i	150		01.09					
	sDrive 23i	150		01.09	02.10		G1201213	24559 17,8 +WD/Acc/S LUC	
	sDrive 30i	190		01.09	02.10				
	sDrive 18i	115		03.13			G1201213	24559 17,8 +WD/Acc/S LUC	
	sDrive 20i	135		09.11					
	sDrive 23i	150		03.10					
	sDrive 28i	180		09.11					
	sDrive 30i	190		03.10					
<b>BMW Z8 (00-03)</b>									
	4.9	294		06.00	08.03		G1020683	21484 20,5 +WD ATE	
	4.9	294		06.00	08.03		G1020367	21487 17,3 +WD ATE	
<b>CHEVROLET AVEO (T200,T250) (04-11)</b>									
	1.2 i	53		03.06	07.11		G2120115	hub diameter=60 <sup>1)</sup> 236 20,0 17,0 V L +S +C	
	1.2 i	55		01.08	07.11				
	1.2 i	56		03.06	07.11				
	1.2 i	62		01.08	07.11				
	1.2 LPG	62		04.08	07.11				
	1.4 CNG	69		01.10	07.11				
	1.4 i 16V	69		03.06	07.11				
	1.4 i 16V	74		01.08	07.11				
	1.5 i	62		05.05	07.11				
	1.6 i 16V	75		03.06	07.11				
	1.6 i 16V	76		05.05	07.11				
	1.6 i 16V	77		12.04	07.11				
	<b>CHEVROLET CAPTIVA (06-)</b>								
		2.0 4WD	110		06.06			G1020979	24510 17,0 +WI
2.0 VCDi		110		09.07					
2.0 VCDi 4WD		110		10.06					
2.0 VDCi		93		10.06					
2.0 VDCi 4WD		93		10.06					
2.2 VCDi		120		03.11					
2.2 VCDi 4WD		120		03.11					
2.2 VCDi 4WD		135		03.11					
2.4		100		06.06					
2.4		103		12.06					
2.4		123		03.11					

<sup>1)</sup> diametro mozzo=60 / diamètre du moyeu=60 / diámetro del buje=60 / Naben D=60























								
<b>CHEVROLET CAPTIVA (06-)</b>								
	2.4 4WD 2.4 4WD 2.4 4WD 2.4 LPG 2.4 LPG 4WD 3.0 4WD 3.0 Flex 3.2 4WD	100 103 123 100 100 190 197 169		06.06 12.06 03.11 01.07 01.07 01.10 01.11 06.06		G1020979		24510 17,0 +/Wl
	2.0 4WD 2.0 VCDi 2.0 VCDi 4WD 2.0 VDCi 2.0 VDCi 4WD 2.2 VCDi 2.2 VCDi 4WD 2.2 VCDi 4WD 2.4 2.4 2.4 2.4 4WD 2.4 4WD 2.4 4WD 2.4 4WD 2.4 LPG 2.4 LPG 4WD 3.0 4WD 3.0 Flex 3.2 4WD	110 110 110 93 93 120 120 135 100 103 123 100 103 123 100 100 100 190 197 169		06.06 09.07 10.06 10.06 10.06 03.11 03.11 03.11 06.06 12.06 03.11 06.06 12.06 03.11 01.07 01.07 01.10 01.11 06.06		G1020981		24498 14,7 +/Wl/Acc
<b>CHEVROLET CRUZE (09-)</b>								
	1.4 16V 1.6 16V 1.6 16V 1.6 16V 1.7 D 1.8 16V 1.8 16V 1.8 16V LPG 1.8 Flex 2.0 CDI 2.0 CDI 2.0 CDI 2.0 CDI	103 80 83 91 96 103 104 104 106 90 92 110 120		08.12 05.09 05.09 05.09 01.12 11.09 05.09 06.11 01.11 05.09 05.09 05.09 08.10		G1020928	+ 16" wheel <sup>1)</sup>	24034 19,1 +/Wl/Acc
	1.4 16V 1.6 16V 1.6 16V 1.6 16V 1.7 D 1.8 16V 1.8 16V 1.8 16V LPG 1.8 Flex 2.0 CDI 2.0 CDI 2.0 CDI 2.0 CDI	103 80 83 91 96 103 104 104 106 90 92 110 120		08.12 11.12 05.09 11.12 05.09 11.12 05.09 11.12 01.12 11.12 11.09 11.12 05.09 11.12 06.11 11.12 01.11 11.12 05.09 11.12 05.09 11.12 05.09 11.12 08.10 11.12		G1020953	+ 15"/16" wheel <sup>2)</sup>	25096 17,0 +/Wl/Acc ATE
	1.4 16V 1.6 16V 1.6 16V 1.6 16V 1.7 D 1.8 16V 1.8 16V 1.8 16V LPG 1.8 Flex 2.0 CDI 2.0 CDI 2.0 CDI 2.0 CDI	103 80 83 91 96 103 104 104 106 90 92 110 120		12.12 12.12 12.12 12.12 12.12 12.12 12.12 12.12 12.12 12.12 12.12 12.12 12.12		G1020953	+ 16" wheel <sup>1)</sup>	25096 17,0 +/Wl/Acc ATE
<b>CHEVROLET KALOS (05-08)</b>								
	1.2 i 1.4 i 1.4 i 16V	53 61 69		03.05 05.08 03.05 05.08 03.05 05.08		G2120115	hub diameter=60 <sup>3)</sup>	236 20,0 17,0 V L +S +C
<b>CHEVROLET LANOS (05-)</b>								
	1.4 1.5 1.6 i 16V	55 63 78		11.05 11.05 11.05		G1020317 G1020258		20547 16,5 +/WD ATE 21190 17,5 +/WD ATE
	1.4 1.5 1.6 i 16V	55 63 78		11.05 11.05 11.05		G2120115 G2124115		236 20,0 17,0 V L +S +C 256 24,0 21,0 V L +S +C

<sup>1)</sup> + ruota 16" / + roue 16" / + rueda 16" / + 16" Rad

<sup>2)</sup> + ruota 15"/16" / + roue 15"/16" / + rueda 15"/16" / + 15"/16" Rad

<sup>3)</sup> diametro mozzo=60 / diamètre du moyeu=60 / diametro del buje=60 / Naben D=60







        											
<b>CHEVROLET MALIBU (V300) (12-)</b>											
	2.0 16V	104		02.12		+ 16" wheel <sup>1)</sup>	G1201143			24415 19,1 +/W/Acc	MAN
	2.0 16V	108		12.12		+ 16" wheel <sup>1)</sup>					
	2.0 LPG	101		02.12		+ 16" wheel <sup>1)</sup>					
	2.0 VDCi	118		04.12		+ 16" wheel <sup>1)</sup>					
	2.4 16V	123		01.12		+ 16" wheel <sup>1)</sup>					
	2.4 16V	125		01.12		+ 16" wheel <sup>1)</sup>					
	2.4 16V	137		01.12		+ 16" wheel <sup>1)</sup>					
	2.0 16V	104		02.12		+ 17" wheel <sup>2)</sup>	G1201145			24412 19,0 +/W/Acc	MAN
	2.0 16V	108		12.12		+ 17" wheel <sup>2)</sup>					
	2.0 LPG	101		02.12		+ 17" wheel <sup>2)</sup>					
2.0 VDCi	118		04.12		+ 17" wheel <sup>2)</sup>						
2.4 16V	123		01.12		+ 17" wheel <sup>2)</sup>						
2.4 16V	125		01.12		+ 17" wheel <sup>2)</sup>						
2.4 16V	137		01.12		+ 17" wheel <sup>2)</sup>						
<b>CHEVROLET MATIZ (05-10)</b>											
	0.8	38		03.05	12.10		G2113195			236 12,6 9,7 +C	
	0.8 LPG	38		03.05	12.10						
	1.0	47		03.05	12.10						
	1.0	48		01.07	12.10						
	1.0	49		03.05	12.10						
	1.0 LPG	44		01.07	12.10						
	1.0 LPG	49		03.05	12.10						
<b>CHEVROLET ORLANDO (11-)</b>											
	1.8 16V	104		02.11			G1020928			24034 19,1 +/W/Acc	
	1.8 LPG	104		06.11							
	2.0 D	96		02.11							
	2.0 D	120		02.11							
	2.0 LPG	103		02.12							
	1.4 16V	103		06.12			G1020953			25096 17,0 +/W/Acc	ATE
	1.8 16V	104		02.11							
	1.8 LPG	104		06.11							
	2.0 D	96		02.11							
	2.0 D	120		02.11							
	2.0 LPG	103		02.12							
<b>CHEVROLET SPARK (05-10)</b>											
	0.8	37		05.05	02.10		G2113195			236 12,6 9,7 +C	
	1.0 LPG	46		05.05	02.10						
	1.0 SX	44		06.09	02.10						
	1.0 SX	46		05.05	02.10						
	1.0 SX	49		05.05	02.10						
<b>CHEVROLET VOLT (11-)</b>											
	EV 150	111		11.11			G1020928			24034 19,1 +/W/Acc	
	EV 150	111		11.11			G1020953		electric parking brake <sup>3)</sup>	25096 17,0 +/W/Acc	ATE
<b>CHRYSLER 300 M (LR) (98-04)</b>											
	2.7 V6	149		11.98	08.00		G1205203			23561 18,1 +	
	2.7 V6	150		08.00	09.04						
	3.5 V6	185		08.00	09.04						
	3.5 V6	187		07.98	08.00						
<b>CHRYSLER CONCORDE (C_41) (97-03)</b>											
	2.7 V6	149		10.97	09.03		G1205203			23561 18,1 +	
	3.5 V6	174		10.97	09.03						
	3.5 V6 Supercharged	186		10.97	09.03						
<b>CHRYSLER CROSSFIRE Coupe (03-08)</b>											
	3.2 V6	160		07.03	01.08		G1020401			21670 19,4 +/WD	ATE
	3.2 SRT-6	246		09.04	08.06		G1020683			21484 20,5 +/WD	ATE
	3.2 V6	160		07.03	01.08		G2125110			288 25,0 22,4 V L +S +C	
	3.2 V6	160		07.03	01.08		G1020441			21919 15,3 /Acc	ATE
	3.2 SRT-6	246		09.04	08.06		G1020400			21305 16,1 /WD	ATE
	3.2 V6	160		07.03	01.08		G2109114			278 9,0 7,3 +S +C	
<b>CHRYSLER CROSSFIRE Convertible (04-08)</b>											
	3.2 V6	160		05.04	01.08		G1020401			21670 19,4 +/WD	ATE
	3.2 SRT-6	246		09.04	08.06		G1020683			21484 20,5 +/WD	ATE
	3.2 V6	160		05.04	01.08		G2125110			288 25,0 22,4 V L +S +C	

<sup>1)</sup> + ruota 16" / + roue 16" / + rueda 16" / + 16" Rad

<sup>2)</sup> + ruota 17" / + roue 17" / + rueda 17" / + 17" Rad

<sup>3)</sup> fr. di stazionamento elettrico / frein à main électrique / freno de mano eléctrico / elektrische Feststellbremse

										
<b>CHRYSLER CROSSFIRE Convertible (04-08)</b>										
	3.2 V6	160		05.04	01.08		G1020441	21919 15,3 /Acc	ATE	
	3.2 SRT-6	246		09.04	08.06		G1020400	21305 16,1 /WD	ATE	
	3.2 V6	160		05.04	01.08		G2109114	278 9,0 7,3 +S +C		
<b>CHRYSLER NEON (PL) (94-99)</b>										
	1.8 16V	85		09.97	08.99		G1205203	for 5 bore wheel rim <sup>1)</sup>	23561 18,1 +	
	2.0 16V	98		01.95	08.99					
	2.0 16V	107		06.94	08.99					
	2.0 16V	109		04.96	08.99					
<b>CHRYSLER NEON II (99-06)</b>										
	1.6 16V	85		11.01	12.06 + ABS		G1205203		23561 18,1 +	
	2.0 16V	97		10.02	12.06					
	2.0 16V	98		08.99	12.06					
	2.0 16V R/T	110		10.01	12.06					
<b>CHRYSLER PT CRUISER (00-10)</b>										
	1.6 16V	85		11.01	09.10		G1205215		23532 20,1 +/M/S	LUC
	2.0 16V	100		10.04	09.10					
	2.0 16V	104		06.00	09.10					
	2.2 CRD	89		03.02	09.10					
	2.2 CRD	110		08.05	09.10					
	2.4 16V	105		03.04	09.10					
	2.4 16V	110		06.00	09.10					
	2.4 16V	169		09.04	09.10					
	2.4 GT Turbo	164		08.03	09.10					
	1.6 16V	85		11.01	09.10 + ABS		G1205203		23561 18,1 +	
	2.0 16V	100		10.04	09.10					
	2.0 16V	104		06.00	09.10					
	2.2 CRD	89		03.02	09.10					
	2.2 CRD	110		08.05	09.10					
	2.4 16V	105		03.04	09.10					
	2.4 16V	110		06.00	09.10					
	2.4 16V	169		09.04	09.10					
	2.4 GT Turbo	164		08.03	09.10					
<b>CHRYSLER STRATUS (JA,JX) (95-01)</b>										
	2.5 LX V6	120		12.95	04.01		G1205203		23561 18,1 +	
	2.5 V6	125		12.95	04.01					
<b>CHRYSLER SEBRING (JR) (01-07)</b>										
	2.4 16V	105		04.01	06.07		G1205203		23561 18,1 +	
	2.4 16V	112		04.01	06.07					
	2.4 16V Turbo	164		09.01	06.07					
	2.7 V6	149		04.01	06.07					
<b>CHRYSLER SEBRING (JS) (07-10)</b>										
	2.0 CRD	103		07.07	12.10		G1205241		23584 16,4 /M	AKE
	2.0 VVT	115		07.07	12.10					
	2.4 VVT	125		07.07	12.10					
	2.7 VVT	137		07.07	12.10					
	2.7 VVT	141		07.07	12.10					
	3.5 V6 AWD	175		11.07	12.10					
<b>CHRYSLER SEBRING Convertible (JR) (01-07)</b>										
	2.0 16V	104		04.01	06.07		G1205203		23561 18,1 +	
	2.4 16V	112		04.01	06.07					
	2.4 16V Turbo	164		09.01	06.07					
	2.7 V6	149		04.01	06.07					
<b>CHRYSLER SEBRING Convertible (JS) (07-10)</b>										
	2.0 CRD	103		07.07	12.10		G1205241		23584 16,4 /M	AKE
	2.4 VVT	125		07.07	12.10					
	2.7 VVT	137		07.07	12.10					
	2.7 VVT	141		07.07	12.10					
	3.5 V6 AWD	175		11.07	12.10					
	2.0 CRD	103		07.07	12.10		G1205230	+ ABS	23582 16,0 +	
	2.4 VVT	125		07.07	12.10					
	2.7 VVT	137		07.07	12.10					
	2.7 VVT	141		07.07	12.10					
	3.5 V6 AWD	175		11.07	12.10					
<b>CHRYSLER VOYAGER (GS) (95-01)</b>										
	2.0 i	98		01.95	09.96		G1205203	+ ABS	23561 18,1 +	
	2.4 i	111		01.95	09.96					
	2.5 TD	85		01.95	09.96					
	2.5 TDiC AWD	85		10.95	09.96					
	3.0	112		01.95	09.96					
	3.3 i	116		01.95	09.96					
	3.3 i	134		01.95	09.96					
	3.8 i	121		01.95	09.96					
	3.8 i AWD	122		01.95	09.96					
	3.8 i AWD	131		01.95	09.96					

<sup>1)</sup> per cerchione a 5 fori / pour jante à 5 trous / para Llantas de 5 taladros / für 5-Loch-Felge



### CHRYSLER VOYAGER (RG) (00-08)

	2.4 16V	108		02.00	12.08	G1205366 G1205238	+ 16" wheel 1) + 16" wheel 1)	23807 18,6 + 23638 18,3 +/Wl	ATE LUC
	2.5 CRD	88		08.05	12.08				
	2.5 CRD	105		02.00	12.08				
	2.8 CRD	110		06.04	12.08				
	3.3 V6	128		02.00	12.08				
	3.3 V6	134		09.03	12.08				
	3.3 V6 AWD	128		02.00	12.08				
	3.3 V6 Flex-Fuel	128		02.00	12.08				
	3.8 V6	160		02.00	12.08				
	3.8 V6 AWD	160		02.00	12.08				
	2.4 16V	108		02.00	12.08	G1205234		24036 16,7 +/Wl	
	2.5 CRD	88		08.05	12.08				
	2.5 CRD	105		02.00	12.08				
	2.8 CRD	110		06.04	12.08				
	3.3 V6	128		02.00	12.08				
	3.3 V6	134		09.03	12.08				
	3.3 V6 AWD	128		02.00	12.08				
	3.3 V6 Flex-Fuel	128		02.00	12.08				
	3.8 V6	160		02.00	12.08				
	3.8 V6 AWD	160		02.00	12.08				

### CITROEN AX (86-98)

	10	32	ORGA 05089	09.86		G1020269		21179 16,8 +/Wl	ATE
	10	33	ORGA 05089	07.86					
	10 E	30		12.86	12.88				
	11	40	ORGA 05089	12.86					
	11	44	ORGA 05089	10.89					
	13 Sport		ORGA 05089	04.87					
	14	44	ORGA 05089	12.86					
	14	49	ORGA 05089	06.88					
	14	55	ORGA 05089	03.89					
	14 D		ORGA 05089	09.88					
	14 GT	62	ORGA 05089	01.88		G1020275		21191 16,8 +/Wl	ATE
	10	32	ORGA 05090		06.92				
	10	33	ORGA 05090		12.98				
	10	37		07.92	12.98				
	11	44	ORGA 05090		12.97				
	14	55	ORGA 05090	ORGA 05277					
	14 D		ORGA 05090	ORGA 05277					
	14 GT	62	ORGA 05090		12.92				
	14	55	ORGA 05278		12.96				
	14 D		ORGA 05278		12.97				
	15 D			08.94	12.97	G1020295		20905 18,0 +/Wl	BDX
	14 GTI			06.91	12.96				
	10	32		09.86	06.92				
	10	33		07.86	12.98				
	10	37		07.92	12.98				
	10 E	30		12.86	12.88				
	11	40		12.86	06.90				
	11	44		10.89	12.97				
	14	44		12.86	12.88				
	14	49		06.88	12.89				
	14	55	ORGA 05277	03.89		G2108107		238 8,0 6,0 +S +C	
	14 D		ORGA 05277	09.88					
	14 GTI			06.91	12.96				
	10	32		09.86	06.92				
	10	33		07.86	12.98				
	10	37		07.92	12.98				
	10 E	30		12.86	12.88				
	11	40		12.86	06.90				
	11	44		10.89	12.97				
	14	44		12.86	12.88				
14	49		06.88	12.89					
	14	55	ORGA 05277	03.89		G2120132		247 20,4 18,5 V +S +C	
	14 D		ORGA 05277	09.88					
	14 GTI			06.91	12.96				

### CITROEN BERLINGO (MF) Estate (96-08)

	1.1 i	44	ORGA 09428	07.96		G1020451		23124 19,0 +/Wl/S	LUC
	1.1 i	44	ORGA 09127	07.96					
	1.4 GNC	48	ORGA 09428	11.02					
	1.4 GNC	48	ORGA 09127	11.02					
	1.4 Hybrid	54	ORGA 09428	05.05					
	1.4 Hybrid	54	ORGA 09127	05.05					
	1.4 i	55	ORGA 09428	07.96					
	1.4 i	55	ORGA 09127	07.96					
	1.6 16V	80	ORGA 09127	10.00					
	1.8 D	43	ORGA 09127	07.98					
	1.8 i	66	ORGA 09127	05.97		G1020614		23708 19,0 /S	BOS
	1.9 D	50	ORGA 09127	07.96					
	1.9 D	51	ORGA 09127	07.98					
	2.0 HDi	66	ORGA 09127	12.99					
	electronic vehicle	27		01.00	03.08				
	1.6 16V	80	ORGA 09128		03.08 + ESP				
	1.6 HDi	80		08.05	03.08 + ESP				
	1.6 HDi 90	66		07.05	03.08 + ESP				
	2.0 HDi	66	ORGA 09128		03.08 + ESP				
		1.1 i	44	ORGA 09428	07.96				
1.4 GNC		48	ORGA 09428	11.02					
1.4 Hybrid		54	ORGA 09428	05.05					
1.4 i		55	ORGA 09428	07.96					
electronic vehicle		27		01.00	03.08				
1.1 i		44	ORGA 09127	07.96					
1.4 GNC		48	ORGA 09127	11.02					
1.4 Hybrid		54	ORGA 09127	05.05					
1.4 i		55	ORGA 09127	07.96					
1.6 16V		80	ORGA 09127	10.00					
	1.1 i	44	ORGA 09127	07.96		G2120133		266 20,5 18,5 V +S +C	
	1.4 GNC	48	ORGA 09127	11.02					
	1.4 Hybrid	54	ORGA 09127	05.05					
	1.4 i	55	ORGA 09127	07.96					
	1.6 16V	80	ORGA 09127	10.00					

1) + ruota 16" / + roue 16" / + rueda 16" / + 16" Rad



### CITROEN BERLINGO (MF) Estate (96-08)



















	1.8 D	43	ORGA 09127	07.98		G2120133		266 20,5 18,5 V +S +C
	1.8 i	66	ORGA 09127	05.97				
	1.9 D	50	ORGA 09127	07.96				
	1.9 D	51	ORGA 09127	07.98				
	2.0 HDi	66	ORGA 09127	12.99				
	1.1 i	44	ORGA 09429		03.08	G2122194		266 22,0 20,0 V +S +C
	1.1 i	44	ORGA 09128		03.08			
	1.4 Bivalent			11.02	03.08			
	1.4 GNC	48	ORGA 09429		03.08			
	1.4 GNC	48	ORGA 09128		03.08			
	1.4 Hybrid	54	ORGA 09429		03.08			
	1.4 Hybrid	54	ORGA 09128		03.08			
	1.4 i	55	ORGA 09429		03.08			
	1.4 i	55	ORGA 09128		03.08			
	1.6 16V	80	ORGA 09128		03.08			
	1.6 HDi	80		08.05	03.08			
	1.6 HDi 75	55		07.05	03.08			
	1.6 HDi 90	66		07.05	03.08			
	1.8 D	43	ORGA 09128		03.08			
	1.8 i	66	ORGA 09128		03.08			
	1.9 D	50	ORGA 09128		03.08			
1.9 D	51	ORGA 09128		03.08				
2.0 HDi	66	ORGA 09128		03.08				
	1.6 16V	80	ORGA 09128		03.08	G2126120		283 26,0 24,0 V +S +C
	1.6 HDi	80		08.05	03.08			
	1.6 HDi 90	66		07.05	03.08			
	2.0 HDi	66	ORGA 09128		03.08			
	1.6 16V	80		10.00	03.08	G1020492		23554 17,1 /WD/S LUC
	1.6 HDi	80		08.05	03.08			
	1.6 HDi 90	66		07.05	03.08			
	2.0 HDi	66		12.99	03.08			
	1.6 16V	80		10.00	03.08	G2109137		247 9,0 8,0 +S +C
	1.6 HDi	80		08.05	03.08			
	1.6 HDi 90	66		07.05	03.08			
	2.0 HDi	66		12.99	03.08			

### CITROEN BERLINGO (M\_) Van (96-08)

	1.1 i	44	ORGA 09428	07.96		G1020451		23124 19,0 +/W/S LUC
	1.1 i	44	ORGA 09127	07.96				
	1.4 i	55	ORGA 09428	07.96				
	1.4 i	55	ORGA 09127	07.96				
	1.6 16V	80	ORGA 09127	10.00				
	1.8 D	43	ORGA 09127	07.96				
	2.0 HDi 90	66	ORGA 09127	12.99				
	1.1 i	44	ORGA 09428	07.96		G2113184		266 13,0 11,0 +S +C
	1.4 i	55	ORGA 09428	07.96				
	1.1 i	44	ORGA 09127	07.96		G2120133		266 20,5 18,5 V +S +C
	1.4 i	55	ORGA 09127	07.96				
	1.6 16V	80	ORGA 09127	10.00				
	1.8 D	43	ORGA 09127	07.96				
	1.9 D	51	ORGA 09127	07.96				
	2.0 HDi 90	66	ORGA 09127	12.99				
		1.1 i	44	ORGA 09429		03.08	G2122194	
	1.1 i	44	ORGA 09128		03.08			
	1.4	48		11.02	03.08			
	1.4 Bivalent	55		11.02	03.08			
	1.4 i	55	ORGA 09429		03.08			
	1.4 i	55	ORGA 09128		03.08			
	1.6 16V	80	ORGA 09128		03.08			
	1.6 HDi 75	55		07.05	03.08			
	1.8 D	43	ORGA 09128		03.08			
	1.9 D	51	ORGA 09128		03.08			
	2.0 HDi 90	66	ORGA 09128		03.08			
	2.0 HDi 90	66		12.99	03.08	G1020492		23554 17,1 /WD/S LUC
	2.0 HDi 90	66		12.99	03.08	G2109137		247 9,0 8,0 +S +C

### CITROEN BERLINGO (B9) (08-)

	1.4 i	55		04.08		G1020790		24538 18,5 + ATE
	1.6 HDi 110	80		04.08				
	1.6 HDi 110	82		07.10				
	1.6 HDi 115	84		07.10				
	1.6 HDi 75	55		04.08				
	1.6 HDi 90	66		04.08				
	1.6 HDi 90	68		07.10				
	1.6 i 16V	66		04.08				
	1.6 i 16V	80		04.08				
	1.6 VTi 120	88		11.09				
	1.6 VTi 95	72		07.10				
	Electric	42		02.13				

							
<b>CITROEN BERLINGO (B9) (08-)</b>							
	1.4 i 1.6 HDi 110 1.6 HDi 110 1.6 HDi 115 1.6 HDi 75 1.6 HDi 90 1.6 HDi 90 1.6 i 16V 1.6 i 16V 1.6 VTi 120 1.6 VTi 95 Electric	55 80 82 84 55 66 68 66 80 88 72 42		04.08 04.08 07.10 07.10 04.08 04.08 07.10 04.08 04.08 11.09 07.10 02.13		G2126120	283 26,0 24,0 V +S +C
	1.4 i 1.6 HDi 110 1.6 HDi 110 1.6 HDi 115 1.6 HDi 75 1.6 HDi 90 1.6 HDi 90 1.6 i 16V 1.6 i 16V 1.6 VTi 120 1.6 VTi 95 Electric	55 80 82 84 55 66 68 66 80 88 72 42		04.08 04.08 07.10 07.10 04.08 04.08 07.10 04.08 04.08 11.09 07.10 02.13		G1020921	24765 16,5 /Acc/S LUC
<b>CITROEN C1 (05-)</b>							
	1.0 1.4 HDi	50 40		06.05 06.05	12.08	G1020830	23959 17,0 /Acc/S BOS
	1.0 1.4 HDi	50 40		06.05 06.05	12.08	G2120180	247 20,0 18,0 V +S +C
<b>CITROEN C2 (03-09)</b>							
	1.1 i 1.4 16V 1.4 HDi 1.4 i	44 65 50 54		09.03 06.06 09.03 09.03	12.09 - ventilated discs <sup>1)</sup> 12.09 - ventilated discs <sup>1)</sup> 12.09 - ventilated discs <sup>1)</sup> 12.09 - ventilated discs <sup>1)</sup>	G1020686	23407 19,0 /S LUC
	1.4 16V 1.4 HDi 1.4 HDi 1.4 i 1.6 16V 1.6 16V	65 50 50 54 80 80	ORGA 10800 ORGA 10800	06.06 09.03 09.03 09.03 09.03 09.03	12.09 + ventilated discs <sup>2)</sup> 12.09 + ventilated discs/+ 16" wheel 12.09 + ventilated discs/- 16" wheel 12.09 + ventilated discs <sup>2)</sup> 12.09 + 16" wheel <sup>3)</sup> 12.09 - 16" wheel <sup>4)</sup>	G1020687	23409 19,3 /S LUC
	1.1 i 1.4 HDi 1.4 i	44 50 54		09.03 09.03 09.03	12.09 12.09 12.09	G2113184	266 13,0 11,0 +S +C
	1.4 16V 1.4 HDi 1.4 i 1.6 16V 1.6 HDi 1.6 VTS	65 50 54 80 80 90		06.06 09.03 09.03 09.03 09.05 01.05	12.09 12.09 12.09 12.09 12.09 12.09	G2122194	266 22,0 20,0 V +S +C
	1.4 16V 1.4 HDi 1.4 i 1.6 16V 1.6 HDi 1.6 VTS	65 50 54 80 80 90		06.06 09.03 09.03 09.03 09.05 01.05	12.09 12.09 12.09 12.09 12.09 12.09	G1020492	23554 17,1 /WD/S LUC
	1.4 16V 1.4 HDi 1.4 i 1.6 16V 1.6 HDi 1.6 VTS	65 50 54 80 80 90		06.06 09.03 09.03 09.03 09.05 01.05	12.09 12.09 12.09 12.09 12.09 12.09	G2109137	247 9,0 8,0 +S +C
<b>CITROEN C3 (02-09)</b>							
	1.1 i 1.4 bivalent 1.4 HDi 1.4 i	44 54 50 54		02.02 09.05 02.02 02.02	08.09 08.09 08.09 08.09	G1020686	23407 19,0 /S LUC
	1.4 16V 1.4 16V HDi 90 1.6 16V 1.6 16V HDi 110 1.6 16V HDi 90	65 66 80 80 66		12.03 02.02 02.02 09.05 10.05	08.09 08.09 + manual transmission <sup>5)</sup> 08.09 08.09	G1020687	- 16" wheel <sup>4)</sup> 23409 19,3 /S LUC
	1.6 16V 1.6 16V HDi 110	80 80	ORGA 10800 ORGA 10800	02.02 09.05	+ autom.transmission <sup>6)</sup>	G1020614	23708 19,0 /S BOS
	1.6 16V 1.6 16V HDi 110	80 80	ORGA 10800 ORGA 10801	02.02 08.09	+ autom.transmission <sup>6)</sup>	G1020735	23600 19,4 /Acc/S BOS
	1.1 i 1.4 bivalent 1.4 HDi 1.4 i	44 54 50 54		02.02 09.05 02.02 02.02	08.09 08.09 08.09 08.09	G2113184	266 13,0 11,0 +S +C
	1.4 16V	65		12.03	08.09	G2122194	266 22,0 20,0 V +S +C

<sup>1)</sup> - dischi ventilati / - disques ventilés / - disco ventilado / - belüftete Scheiben























<sup>2)</sup> + dischi ventilati / + disques ventilés / + disco ventilado / + belüftete Scheiben

<sup>3)</sup> + ruota 16" / + roue 16" / + rueda 16" / + 16" Rad

<sup>4)</sup> - ruota 16" / - roue 16" / - rueda 16" / - 16" Rad

<sup>5)</sup> + scatola cambio velocità / + transmission mécanique / + cambio de velocidad / + Schaltgetriebe

<sup>6)</sup> + scatola cambio automatico / + transmission automatique / + cambio automático / + Automatikgetriebe

											
<b>CITROEN C3 (02-09)</b>											
	1.4 16V HDi 90	66		02.02	08.09	+ manual transmission 1)	G2122194	266 22,0 20,0 V +S +C			
	1.6 16V	80		02.02	08.09						
	1.6 16V HDi 110	80		09.05	08.09						
	1.6 16V HDi 90	66		10.05	08.09						
	1.6 16V HDi 110	80		09.05	08.09						
	1.6 16V	80		02.02	08.09	+ autom.transmission 2)	G2126120	283 26,0 24,0 V +S +C			
	1.6 16V HDi 110	80		09.05	08.09						
	1.6 16V HDi 90	66		10.05	08.09						
	1.6 16V	80		02.02	08.09	G2109137	247 9,0 8,0 +S +C				
	1.6 16V HDi 110	80		09.05	08.09						
	1.6 16V HDi 90	66		10.05	08.09						
<b>CITROEN C3 Picasso (09-)</b>											
	1.4 VTi 95	70		02.09		G2122194	266 22,0 20,0 V +S +C				
	1.4 VTi 95 LPG	70		01.12							
	1.6 Flex	78		11.09							
	1.6 HDi	80		02.09							
	1.6 HDi 110	82		05.10							
	1.6 HDi 115	84		11.12							
	1.6 HDi 90	66		02.09							
	1.6 HDi 90	68		07.10							
	1.6 VTi 120	88		02.09							
	1.4 VTi 95	70		02.09				G2126120	283 26,0 24,0 V +S +C		
	1.4 VTi 95 LPG	70		01.12							
	1.6 Flex	78		11.09							
	1.6 HDi	80		02.09							
1.6 HDi 110	82		05.10								
1.6 HDi 115	84		11.12								
1.6 HDi 90	66		02.09								
1.6 HDi 90	68		07.10								
1.6 VTi 120	88		02.09								
	1.4 VTi 95	70	ORGA 12774	02.09		G1020920	23554 16,8 /WD/Acc/S			LUC	
	1.6 Flex	78	ORGA 12774	11.09							
	1.6 HDi	80	ORGA 12774	02.09							
	1.6 HDi 110	82	ORGA 12774	05.10							
	1.6 HDi 90	66	ORGA 12774	02.09							
	1.6 HDi 90	68	ORGA 12774	07.10							
	1.6 VTi 120	88	ORGA 12774	02.09							
	1.4 VTi 95	70	ORGA 12775			G1020920	23554 16,8 /WD/Acc/S	LUC			
	1.4 VTi 95 LPG	70		01.12							
	1.6 Flex	78	ORGA 12775								
	1.6 HDi	80	ORGA 12775								
	1.6 HDi 110	82	ORGA 12775								
	1.6 HDi 115	84		11.12							
	1.6 HDi 90	66	ORGA 12775								
	1.6 HDi 90	68	ORGA 12775								
	1.6 VTi 120	88	ORGA 12775								
	<b>CITROEN C3 Pluriel (03-10)</b>										
	1.4 HDi	50		04.04	07.10	G1020687	23409 19,3 /S	LUC			
	1.4 Hybrid	54		05.05	07.10						
	1.4 i	54		05.03	07.10						
	1.6 16V	80		05.03	07.10						
	1.4 HDi	50		04.04	07.10	G2122194	266 22,0 20,0 V +S +C				
	1.4 Hybrid	54		05.05	07.10						
	1.4 i	54		05.03	07.10						
	1.6 16V	80		05.03	07.10						
	1.6 16V	80		05.03	07.10	G1020492	23554 17,1 /WD/S	LUC			
	1.6 16V	80		05.03	07.10						
	1.6 16V	80		05.03	07.10	G2109137	247 9,0 8,0 +S +C				
	1.6 16V	80		05.03	07.10						
<b>CITROEN C3 II (09-)</b>											
	1.0 VTi 68	50		10.12		G2122194	266 22,0 20,0 V +S +C				
	1.1	44		09.09							
	1.2 VTi 82	60		10.12							
	1.4	54		09.09							
	1.4 Flex	58		11.09							
	1.4 HDi 70	50		11.09							
	1.4 VTi 95	70		09.09							
	1.6 HDi	68		11.09							
	1.6 HDi 90	66		09.09							
		1.6 HDi 110	82		09.09				G2126120	283 26,0 24,0 V +S +C	
1.6 HDi 115		84		09.12							
1.6 VTi 120		88		09.09							
	1.6 HDi 110	82	ORGA 12774	09.09		G1020920	23554 16,8 /WD/Acc/S	LUC			
	1.6 VTi 120	88	ORGA 12774	09.09							
	1.6 HDi 110	82	ORGA 12775						G1020920	23554 16,8 /WD/Acc/S	LUC
	1.6 HDi 115	84		09.12							
1.6 VTi 120	88	ORGA 12775									

1) + scatola cambio velocità / + transmission mécanique / + cambio de velocidad / + Schaltgetriebe

2) + scatola cambio automatico / + transmission automatique / + cambio automático / + Automatikgetriebe

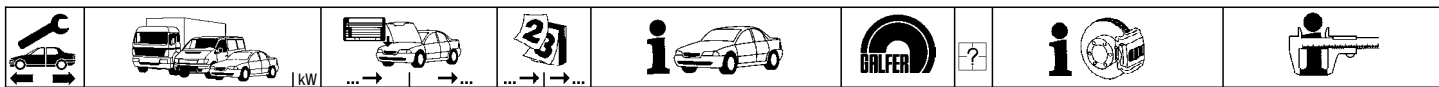

**CITROEN C4 I Saloon (LC\_) (04-10)**

	1.4 16V	65	ORGA 10550	10.04	+ ESP	G1020735		23600 19,4 /Acc/S	BOS	
	1.6 16V	80	ORGA 12053	07.06						
	1.6 16V	80	ORGA 10550	10.04	+ ESP/ + manual transm. 1)					
	1.6 16V	80		10.04	+ autom.transmission 2)					
	1.6 16V Bio Flex	80	ORGA 10550	09.07	+ ESP/ + manual transm. 1)					
	1.6 HDi	66	ORGA 10550	10.04	+ ESP					
	1.6 HDi	80	ORGA 12053	07.06						
	1.6 HDi	80	ORGA 12053	10.04	+ ESP					
	1.6 THP 140	103		07.08	09.10					
	1.6 THP 150	110		07.08	09.10					
1.6 VTi	88		07.08	09.10	+ autom.transmission 2)					
2.0 16V	100		10.04	09.10						
2.0 16V	103	ORGA 12053	07.06							
2.0 16V	103	ORGA 12053	10.04							
2.0 16V	130		11.04	09.10	G1020745		23589 19,1 +	ATE		
2.0 HDi	103		07.08	09.10						
2.0 HDi 135	100		10.04	09.10						
	1.4 16V	65	ORGA 10551	09.10	+ ESP	G2122194		266 22,0 20,0 V +S +C		
	1.4 16V	65		10.04	- ESP					
	1.6 16V	80	ORGA 10551	09.10	+ ESP/ + manual transm. 1)					
	1.6 16V	80		10.04	- ESP					
	1.6 16V Bio Flex	80	ORGA 10551	09.10	+ ESP/ + manual transm. 1)					
	1.6 16V Bio Flex	80		09.07	- ESP					
	1.6 HDi	66	ORGA 10551	09.10	+ ESP					
	1.6 HDi	66		10.04	- ESP					
	1.6 VTi	88		07.08	09.10					+ manual transmission 3)
	1.4 16V	65	ORGA 10550	10.04	+ ESP					G2126120
1.6 16V	80	ORGA 10550	10.04	+ ESP/ + manual transm. 1)						
1.6 16V	80		07.06	09.10						
1.6 16V	80		10.04	09.10	+ autom.transmission 2)					
1.6 16V Bio Flex	80	ORGA 10550	09.07	+ ESP/ + manual transm. 1)						
1.6 HDi	66	ORGA 10550	10.04	+ ESP						
1.6 HDi	80		07.06	09.10						
1.6 HDi	80		10.04	09.10	+ ESP					
1.6 THP 140	103		07.08	09.10	+ ESP					
1.6 THP 150	110		07.08	09.10	+ ESP					
1.6 VTi	88		07.08	09.10	+ autom.transmission 2)					
2.0 16V	100		10.04	09.10						
2.0 16V	103		07.06	09.10						
2.0 16V	103		10.04	09.10						
	1.4 16V	65	ORGA 11584	10.04		G1020492		23554 17,1 /WD/S	LUC	
	1.6 16V	80	ORGA 11584	07.06						
	1.6 16V	80	ORGA 11584	10.04						
	1.6 16V Bio Flex	80	ORGA 11584	09.07						
	1.6 HDi	66	ORGA 11584	10.04						
	1.6 HDi	80	ORGA 11584	07.06						
	1.6 HDi	80	ORGA 11584	10.04						
	1.6 THP 140	103	ORGA 11584	07.08						
	1.6 THP 150	110	ORGA 11584	07.08						
	1.6 VTi	88	ORGA 11584	07.08						
2.0 16V	100	ORGA 11584	10.04							
2.0 16V	103	ORGA 11584	07.06							
2.0 16V	103	ORGA 11584	10.04							
2.0 16V	130	ORGA 11584	11.04							
2.0 HDi	103	ORGA 11584	07.08							
2.0 HDi 135	100	ORGA 11584	10.04							
	1.4 16V	65	ORGA 11431	ORGA 12333		G1020920		23554 16,8 /WD/Acc/S	LUC	
	1.6 16V	80	ORGA 11431	ORGA 12333						
	1.6 16V	80	ORGA 11431	ORGA 12333						
	1.6 16V Bio Flex	80	ORGA 11431	ORGA 12333						
	1.6 HDi	66	ORGA 11431	ORGA 12333						
	1.6 HDi	80	ORGA 11431	ORGA 12333						
	1.6 HDi	80	ORGA 11431	ORGA 12333						
	1.6 THP 140	103	ORGA 11431	ORGA 12333						
	1.6 THP 150	110	ORGA 11431	ORGA 12333						
	1.6 VTi	88	ORGA 11431	ORGA 12333						
2.0 16V	100	ORGA 11431	ORGA 12333							
2.0 16V	103	ORGA 11431	ORGA 12333							
2.0 16V	103	ORGA 11431	ORGA 12333							
2.0 16V	130	ORGA 11431	ORGA 12333							
2.0 HDi	103	ORGA 11431	ORGA 12333							
2.0 HDi 135	100	ORGA 11431	ORGA 12333							
	1.4 16V	65	ORGA 12334	09.10		G1020492		23554 17,1 /WD/S	LUC	
	1.6 16V	80	ORGA 12334	09.10						
	1.6 16V	80	ORGA 12334	09.10						
	1.6 16V Bio Flex	80	ORGA 12334	09.10						
	1.6 HDi	66	ORGA 12334	09.10						
	1.6 HDi	80	ORGA 12334	09.10						
	1.6 HDi	80	ORGA 12334	09.10						
	1.6 THP 140	103	ORGA 12334	09.10						
	1.6 THP 150	110	ORGA 12334	09.10						
	1.6 VTi	88	ORGA 12334	09.10						
2.0 16V	100	ORGA 12334	09.10							
2.0 16V	103	ORGA 12334	09.10							
2.0 16V	103	ORGA 12334	09.10							
2.0 16V	130	ORGA 12334	09.10							
2.0 HDi	103	ORGA 12334	09.10							

1) + ESP/+ scatola cambio velocità / + ESP/ + transmission mécanique / + ESP/ + cambio de velocidad / + ESP/ + Schaltgetriebe  
 2) + scatola cambio automatico / + transmission automatique / + cambio automático / + Automatikgetriebe  
 3) + scatola cambio velocità / + transmission mécanique / + cambio de velocidad / + Schaltgetriebe







### CITROEN C4 I Coupe (04-10)





















	1.6 HDi 110	80	ORGA 12334		07.10		G1020492		23554 17,1 /WD/S	LUC
	1.6 HDi 90	66	ORGA 12334		07.10					
	1.6 THP 150	110	ORGA 12334		07.10					
	1.6 VTi 120	88	ORGA 12334		07.10					
	2.0 16V	100	ORGA 12334		07.10					
	2.0 16V	103	ORGA 12334		07.10					
	2.0 16V	130	ORGA 12334		07.10					
	2.0 HDi	103	ORGA 12334		07.10					
	2.0 HDi 135	100	ORGA 12334		07.10					
	1.4 16V	65	ORGA 10656	10.04						
1.6 16V	80	ORGA 10656	10.04							
1.6 HDi 110	80	ORGA 10656	10.04							
1.6 HDi 90	66	ORGA 10656	10.04							
1.6 THP 150	110	ORGA 10656	07.08							
1.6 VTi 120	88	ORGA 10656	07.08							
2.0 16V	100	ORGA 10656	10.04							
2.0 16V	103	ORGA 10656	12.05							
2.0 16V	130	ORGA 10656	10.04							
2.0 HDi	103	ORGA 10656	07.08							
2.0 HDi 135	100	ORGA 10656	10.04							
	1.4 16V	65		10.04	07.10		G2109137		247 9,0 8,0 +S +C	
	1.6 16V	80		10.04	07.10					
	1.6 HDi 110	80		10.04	07.10					
	1.6 HDi 90	66		10.04	07.10					
	1.6 THP 150	110		07.08	07.10					
	1.6 VTi 120	88		07.08	07.10					
	2.0 16V	100		10.04	07.10					
	2.0 16V	103		12.05	07.10					
	2.0 16V	130		10.04	07.10					
	2.0 HDi	103		07.08	07.10					
2.0 HDi 135	100		10.04	07.10						

### CITROEN C4 I Grand Picasso (06-13)

	1.6 e-HDi 110	82		11.10	07.13		G1020790		24538 18,5 +	ATE
	1.6 HDi	80		10.06	07.13					
	1.6 HDi 110	82		09.10	07.13					
	1.6 VTi 120	88		07.08	07.13					
	1.8 i 16V	92		10.06	07.13					
	1.6 16V	103	ORGA 11920	07.08			G1020792		24557 19,4 +	ATE
	1.6 16V	110	ORGA 11920	10.08						
	2.0 HDi 135	100	ORGA 11920	10.06						
	2.0 i 16V	103	ORGA 11920	10.06						
	1.6 16V	103	ORGA 11921		07.13					
1.6 16V	110	ORGA 11921		07.13						
1.6 THP 155	115		11.10	07.13						
2.0 HDi 135	100	ORGA 11921		07.13						
2.0 HDi 150	110		07.09	07.13						
2.0 HDi 165	120		11.10	07.13						
2.0 i 16V	103	ORGA 11921		07.13						
	1.6 e-HDi 110	82		11.10	07.13		G2126120		283 26,0 24,0 V +S +C	
	1.6 HDi	80		10.06	07.13					
	1.6 HDi 110	82		09.10	07.13					
	1.6 VTi 120	88		07.08	07.13					
	1.8 i 16V	92		10.06	07.13					
	1.6 16V	103		07.08	07.13		G1020799		24540 16,3 /Acc/S	BOS
	1.6 16V	110		10.08	07.13					
	1.6 e-HDi 110	82		11.10	07.13					
	1.6 HDi	80		10.06	07.13					
	1.6 HDi 110	82		09.10	07.13					
	1.6 THP 155	115		11.10	07.13					
	1.6 VTi 120	88		07.08	07.13					
	1.8 i 16V	92		10.06	07.13					
	2.0 HDi 135	100		10.06	07.13					
	2.0 HDi 150	110		07.09	07.13					
	2.0 HDi 165	120		11.10	07.13					
	2.0 i 16V	103		10.06	07.13					

### CITROEN C4 I Picasso (07-13)

	1.6 e-HDi 110	82		11.10	07.13		G1020790		24538 18,5 +	ATE
	1.6 HDi	80		02.07	07.13					
	1.6 HDi 110	82		11.10	07.13					
	1.6 VTi 120	88		07.08	07.13					
	1.8 i 16V	92		02.07	07.13					
	1.6 16V	110	ORGA 11920	07.08			G1020792		24557 19,4 +	ATE
	1.6 THP 140	103	ORGA 11920	07.08						
	1.6 THP 150	110	ORGA 11920	10.08						
	2.0 HDi 138	100	ORGA 11920	02.07						
	2.0 i 16V	103	ORGA 11920	02.07						
	1.6 16V	110	ORGA 11921		07.13					
1.6 THP 140	103	ORGA 11921		07.13						
1.6 THP 150	110	ORGA 11921		07.13						
1.6 THP 155	115		11.10	07.13						
2.0 HDi 138	100	ORGA 11921		07.13						
2.0 HDi 150	110		07.09	07.13						
2.0 HDi 165	120		11.10	07.13						
2.0 i 16V	103	ORGA 11921		07.13						

								
<b>CITROEN C4 I Picasso (07-13)</b>								
	1.6 e-HDi 110	82		11.10	07.13		G2126120	283 26,0 24,0 V +S +C
	1.6 HDi	80		02.07	07.13			
	1.6 HDi 110	82		11.10	07.13			
	1.6 VTi 120	88		07.08	07.13			
	1.8 i 16V	92		02.07	07.13			
	1.6 16V	110		07.08	07.13		G1020799	24540 16,3 /Acc/S BOS
	1.6 e-HDi 110	82		11.10	07.13			
	1.6 HDi	80		02.07	07.13			
	1.6 HDi 110	82		11.10	07.13			
	1.6 THP 140	103		07.08	07.13			
	1.6 THP 150	110		10.08	07.13			
	1.6 THP 155	115		11.10	07.13			
	1.6 VTi 120	88		07.08	07.13			
	1.8 i 16V	92		02.07	07.13			
	2.0 HDi 138	100		02.07	07.13			
	2.0 HDi 150	110		07.09	07.13			
	2.0 HDi 165	120		11.10	07.13			
	2.0 i 16V	103		02.07	07.13			
<b>CITROEN C4 II Saloon (B7) (10-)</b>								
	1.6 Flex	81		11.09			G1020790	24538 18,5 + ATE
	1.6 HDi 110	82		11.09				
	1.6 HDi 115	84		07.12				
	1.6 HDi 90	68		11.09		+ electric parking brake <sup>1)</sup>		
	1.6 VTi 120	88		11.09				
	1.6 VTi 120 LPG	88		09.11				
	2.0 Flex	103		11.09				
	1.6 THP 155	115		11.09			G1020792	24557 19,4 + ATE
	2.0 HDi 150	110		11.09				
	1.4 VTi 95	70		11.09			G2122194	266 22,0 20,0 V +S +C
	1.6 HDi 90	68		11.09		- electric parking brake <sup>2)</sup>		
	1.6 Flex	81		11.09			G2126120	283 26,0 24,0 V +S +C
	1.6 HDi 110	82		11.09				
	1.6 HDi 115	84		07.12				
	1.6 HDi 90	68		11.09		+ electric parking brake <sup>1)</sup>		
	1.6 VTi 120	88		11.09				
	1.6 VTi 120 LPG	88		09.11				
	2.0 Flex	103		11.09				
	1.4 VTi 95	70		11.09		+ electric parking brake <sup>1)</sup>	G1020946	24922 17,5 /Acc/S LUC
	1.6 Flex	81		11.09		+ electric parking brake <sup>1)</sup>		
	1.6 HDi 110	82		11.09		+ electric parking brake <sup>1)</sup>		
	1.6 HDi 115	84		07.12		+ electric parking brake <sup>1)</sup>		
	1.6 HDi 90	68		11.09		+ electric parking brake <sup>1)</sup>		
	1.6 THP 155	115		11.09				
	1.6 VTi 120	88		11.09		+ electric parking brake <sup>1)</sup>		
	1.6 VTi 120 LPG	88		09.11		+ electric parking brake <sup>1)</sup>		
	2.0 Flex	103		11.09		+ electric parking brake <sup>1)</sup>		
	2.0 HDi 150	110		11.09		+ electric parking brake <sup>1)</sup>		
<b>CITROEN C4 Aircross (12-)</b>								
	1.6 16V 2WD	86		04.12			G1205241	23584 16,4 /Wl AKE
	1.6 HDi 115 2WD	84		04.12			G1205241	23584 16,4 /Wl AKE
	1.6 HDi 115 4WD	84		05.12				
	1.8 HDi 150 2WD	110		04.12				
	1.8 HDi 150 4WD	110		04.12				
	1.6 16V 2WD	86		04.12			G1205230	23582 16,0 +
	1.6 HDi 115 2WD	84		04.12				
	1.6 HDi 115 4WD	84		05.12				
	1.8 HDi 150 2WD	110		04.12				
	1.8 HDi 150 4WD	110		04.12				
<b>CITROEN C-ELYSEE (12-)</b>								
	1.2 VTi 72	53		11.12			G2113184	266 13,0 11,0 +S +C
	1.6 HDi 92	68		11.12			G2122194	266 22,0 20,0 V +S +C
	1.6 VTi 115	85		11.12				
<b>CITROEN C5 I Saloon (01-04)</b>								
	2.0 16V	100		03.01	08.04		G1020602	23277 17,7 /Wl/S BOS
	2.0 16V	103		03.01	08.04			
	2.0 HDi 110	80		03.01	08.04			
	2.0 HDi 90	66		03.01	08.04			
	2.2 HDi	98		03.01	08.04		G1020603	23273 17,8 /Wl/S BOS
	3.0 V6	152		03.01	08.04			
	1.8 16V	85		03.01	08.04		G2122194	266 22,0 20,0 V +S +C
	2.0 16V	100		03.01	08.04		G2126120	283 26,0 24,0 V +S +C
	2.0 16V	103		03.01	08.04			
	2.0 HDi 110	80		03.01	08.04			
	2.0 HDi 90	66		03.01	08.04			
	1.8 16V	85		03.01	08.04		G1020604	23305 15,2 CIT
	2.0 16V	100		03.01	08.04			
	2.0 16V	103		03.01	08.04			
	2.0 HDi 110	80		03.01	08.04			
	2.0 HDi 90	66		03.01	08.04			
	2.2 HDi	98		03.01	08.04			
	3.0 V6	152		03.01	08.04			

<sup>1)</sup> + freno a mano elettrico / + frein à main électrique / + freno de mano eléctrico / + elektrische Feststellbremse

<sup>2)</sup> - freno a mano elettrico / - frein à main électrique / - freno de mano eléctrico / - elektrische Feststellbremse



CITROEN C5 I Estate (01-04)										
	1.8 16V	85		06.01	08.04	G1020602			23277 17,7 /W/S	BOS
	2.0 16V	100		06.01	08.04					
	2.0 16V	103		06.01	08.04					
	2.0 HDi 110	80		06.01	08.04					
	2.0 HDi 90	66		06.01	08.04					
	2.2 HDi	98		06.01	08.04	G1020603			23273 17,8 /W/S	BOS
	3.0 V6	152		06.01	08.04					
	3.0 V6 Carlsson	173		09.03	08.04					
	1.8 16V	85		06.01	08.04	G2126120			283 26,0 24,0 V +S +C	
	2.0 16V	100		06.01	08.04					
	2.0 16V	103		06.01	08.04					
	2.0 HDi 110	80		06.01	08.04					
	2.0 HDi 90	66		06.01	08.04					
	1.8 16V	85		06.01	08.04	G1020604			23305 15,2	CIT
	2.0 16V	100		06.01	08.04					
	2.0 16V	103		06.01	08.04					
	2.0 HDi 110	80		06.01	08.04					
	2.0 HDi 90	66		06.01	08.04					
	2.2 HDi	98		06.01	08.04					
	3.0 V6	152		06.01	08.04					
3.0 V6 Carlsson	173		09.03	08.04						

CITROEN C5 II Saloon (04-08)										
	1.6 HDi	80		09.04	01.08	G1020602			23277 17,7 /W/S	BOS
	2.0 16V	103		09.04	01.08					
	2.0 HDi	100		09.04	01.08					
	2.2 HDi	98		09.04	01.08					
	2.2 HDi	125		04.06	01.08					
	3.0 Carlsson	173		09.04	01.08					
	3.0 V6	152		09.04	01.08	G1020603			23273 17,8 /W/S	BOS
	1.8 16V	85		09.04	01.08					
	1.8 16V	92		09.05	01.08					
	1.6 HDi	80		09.04	01.08	G2126120			283 26,0 24,0 V +S +C	
	2.0 16V	103		09.04	01.08					
	1.6 HDi	80		09.04	01.08					
	1.6 HDi	80		09.04	01.08	G1020604			23305 15,2	CIT
	1.8 16V	85		09.04	01.08					
	1.8 16V	92		09.05	01.08					
	2.0 16V	103		09.04	01.08					
	2.0 HDi	100		09.04	01.08					
	2.2 HDi	98		09.04	01.08					
	2.2 HDi	125		04.06	01.08					
	3.0 Carlsson	173		09.04	01.08					
	3.0 V6	152		09.04	01.08					

CITROEN C5 II Estate (04-08)										
	1.6 HDi	80		09.04	01.08	G1020602			23277 17,7 /W/S	BOS
	1.8 16V	85		09.04	01.08					
	1.8 16V	92		09.05	01.08					
	2.0 16V	103		09.04	01.08					
	2.0 HDi	100		09.04	01.08					
	2.2 HDi	98		09.04	01.08	G1020603			23273 17,8 /W/S	BOS
	2.2 HDi	120		05.06	01.08					
	2.2 HDi	125		04.06	01.08					
	3.0 V6	152		09.04	01.08					
	1.6 HDi	80		09.04	01.08					
	1.8 16V	85		09.04	01.08					
	1.8 16V	92		09.05	01.08	G2126120			283 26,0 24,0 V +S +C	
	2.0 16V	103		09.04	01.08					
	1.6 HDi	80		09.04	01.08					
	1.8 16V	85		09.04	01.08					
	1.8 16V	92		09.05	01.08	G1020604			23305 15,2	CIT
	2.0 16V	103		09.04	01.08					
	2.0 HDi	100		09.04	01.08					
	2.2 HDi	98		09.04	01.08					
	2.2 HDi	120		05.06	01.08					
	2.2 HDi	125		04.06	01.08					
	3.0 V6	152		09.04	01.08					

CITROEN C5 III Saloon (X7) (08-)										
	1.6 HDi	80		02.08		G1020893			24332 18,3 +/W/I	ATE
	1.6 HDi 110	82		07.10						
	1.6 HDi 115	84		01.12						
	1.6 VTi 120	88		07.10						
	1.8 16V	92		02.08						
	2.0 16V	103		02.08						
	2.0 16V BioFlex	103		02.08						
	2.0 HDi	100		02.08						
	2.0 HDi 140	103		11.08						
	2.0 HDi 165	120		04.09						
	1.6 THP 155	115		04.09		G1020762			24133 18,6 +/W/I/Acc/S	LUC
	2.2 HDi	125		02.08						
	2.2 HDi 200	150		07.10						
	2.7 HDi	150		02.08						
	3.0	152		02.08						
	3.0 V6	155		02.08						

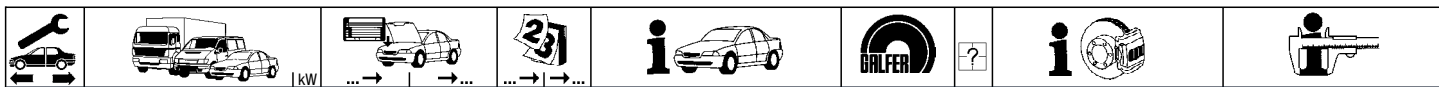

**CITROEN C5 III Saloon (X7) (08-)**

	1.6 HDi	80	02.08	- electric parking brake <sup>1)</sup>	G1020660		24135 17,7 /S	LUC
	1.6 HDi 110	82	07.10	- electric parking brake <sup>1)</sup>				
	1.6 HDi 115	84	01.12	- electric parking brake <sup>1)</sup>				
	1.6 THP 155	115	04.09	- electric parking brake <sup>1)</sup>				
	1.6 VTI 120	88	07.10	- electric parking brake <sup>1)</sup>				
	1.8 16V	92	02.08	- electric parking brake <sup>1)</sup>				
	2.0 16V	103	02.08	- electric parking brake <sup>1)</sup>				
	2.0 16V BioFlex	103	02.08	- electric parking brake <sup>1)</sup>				
	2.0 HDi	100	02.08	- electric parking brake <sup>1)</sup>				
	2.0 HDi 140	103	11.08	- electric parking brake <sup>1)</sup>				
	2.0 HDi 165	120	04.09	- electric parking brake <sup>1)</sup>				
	2.2 HDi	125	02.08	- electric parking brake <sup>1)</sup>				
	2.2 HDi 200	150	07.10	- electric parking brake <sup>1)</sup>				
	2.7 HDi	150	02.08	- electric parking brake <sup>1)</sup>				
3.0	152	02.08	- electric parking brake <sup>1)</sup>					
3.0 HDi 240	177	04.09	- electric parking brake <sup>1)</sup>					
3.0 V6	155	02.08	- electric parking brake <sup>1)</sup>					

	1.6 HDi	80	02.08		G2112162		290 12,0 10,0 +S +C	
	1.6 HDi 110	82	07.10					
	1.6 HDi 115	84	01.12					
	1.6 THP 155	115	04.09					
	1.6 VTI 120	88	07.10					
	1.8 16V	92	02.08					
	2.0 16V	103	02.08					
	2.0 16V BioFlex	103	02.08					
	2.0 HDi	100	02.08					
	2.0 HDi 140	103	11.08					
	2.0 HDi 165	120	04.09					
	2.2 HDi	125	02.08					
	2.2 HDi 200	150	07.10					
	2.7 HDi	150	02.08					
3.0	152	02.08						
3.0 HDi 240	177	04.09						
3.0 V6	155	02.08						

**CITROEN C5 III Estate (X7) (08-)**

	1.6 HDi	80	02.08		G1020893		24332 18,3 +/WI	ATE
	1.6 HDi 110	82	07.10					
	1.6 HDi 115	84	01.12					
	1.6 VTI 120	88	07.10					
	1.8 16V	92	02.08					
	2.0 16V	103	02.08					
	2.0 16V BioFlex	103	02.08					
	2.0 HDi	100	02.08					
	2.0 HDi 140	103	11.08					
	2.0 HDi 150	110	04.09					
2.0 HDi 165	120	04.09						
	1.6 THP 155	115	04.09		G1020762		24133 18,6 +/WI/Acc/S	LUC
	2.2 HDi	125	02.08					
	2.2 HDi 200	150	07.10					
	2.7 HDi	150	02.08					
	3.0	152	02.08					
3.0 V6	155	02.08						

	1.6 HDi	80	02.08	- electric parking brake <sup>1)</sup>	G1020660		24135 17,7 /S	LUC
	1.6 HDi 110	82	07.10	- electric parking brake <sup>1)</sup>				
	1.6 HDi 115	84	01.12	- electric parking brake <sup>1)</sup>				
	1.6 THP 155	115	04.09	- electric parking brake <sup>1)</sup>				
	1.6 VTI 120	88	07.10	- electric parking brake <sup>1)</sup>				
	1.8 16V	92	02.08	- electric parking brake <sup>1)</sup>				
	2.0 16V	103	02.08	- electric parking brake <sup>1)</sup>				
	2.0 16V BioFlex	103	02.08	- electric parking brake <sup>1)</sup>				
	2.0 HDi	100	02.08	- electric parking brake <sup>1)</sup>				
	2.0 HDi 140	103	11.08	- electric parking brake <sup>1)</sup>				
	2.0 HDi 150	110	04.09	- electric parking brake <sup>1)</sup>				
	2.0 HDi 165	120	04.09	- electric parking brake <sup>1)</sup>				
	2.2 HDi	125	02.08	- electric parking brake <sup>1)</sup>				
	2.2 HDi 200	150	07.10	- electric parking brake <sup>1)</sup>				
2.7 HDi	150	02.08	- electric parking brake <sup>1)</sup>					
3.0	152	02.08	- electric parking brake <sup>1)</sup>					
3.0 HDi 240	177	04.09	- electric parking brake <sup>1)</sup>					
3.0 V6	155	02.08	- electric parking brake <sup>1)</sup>					

	1.6 HDi	80	02.08		G2112162		290 12,0 10,0 +S +C	
	1.6 HDi 110	82	07.10					
	1.6 HDi 115	84	01.12					
	1.6 THP 155	115	04.09					
	1.6 VTI 120	88	07.10					
	1.8 16V	92	02.08					
	2.0 16V	103	02.08					
	2.0 16V BioFlex	103	02.08					
	2.0 HDi	100	02.08					
	2.0 HDi 140	103	11.08					
	2.0 HDi 150	110	04.09					
	2.0 HDi 165	120	04.09					
	2.2 HDi	125	02.08					
	2.2 HDi 200	150	07.10					
2.7 HDi	150	02.08						

<sup>1)</sup> - freno a mano elettrico / - frein à main électrique / - freno de mano eléctrico / - elektrische Feststellbremse



       										
<b>CITROEN C5 III Estate (X7) (08-)</b>										
	3.0 3.0 HDi 240 3.0 V6	152 177 155		02.08 04.09 02.08					G2112162	290 12,0 10,0 +S +C
<b>CITROEN C6 (05-12)</b>										
	2.2 HDi 2.7 HDi 3.0 V6	125 150 155		06.06 09.05 09.05	12.12 12.12 12.12				G1020762	24133 18,6 +/M/Acc/S LUC
<b>CITROEN C8 (02-)</b>										
	2.0 16V 2.0 16V 2.0 HDi 2.0 HDi 2.0 HDi 135 2.2 16V 2.2 HDi	100 103 79 88 100 116 94		07.02 09.05 07.02 02.07 03.06 07.02 07.02					G1020514	20261 19,0 +/M/S LUC
	2.0 16V 2.0 16V 2.0 HDi 2.0 HDi 2.0 HDi 135 2.2 16V 2.2 HDi 2.2 HDi 3.0 V6	100 103 79 88 100 116 94 125 150		07.02 09.05 07.02 02.07 03.06 07.02 07.02 06.06 07.02					G1020549	20961 17,1 /WD/S LUC
<b>CITROEN C-CROSSER (07-13)</b>										
	2.2 HDi 2.4	115 125		02.07 08.08	01.13 01.13				G1205230	23582 16,0 +
<b>CITROEN DS3 (09-)</b>										
	1.2 VTi 82 1.4 VTi 95 1.6 HDi 90	60 70 68		10.12 04.10 11.09					G2122194	266 22,0 20,0 V +S +C
	1.6 HDi 110 1.6 HDi 115 1.6 THP 150 1.6 VTi 120	82 84 115 88		11.09 08.12 04.10 04.10					G2126120	283 26,0 24,0 V +S +C
	1.6 HDi 110 1.6 HDi 115 1.6 Racing 1.6 THP 150 1.6 VTi 120	82 84 115 88		11.09 08.12 02.11 04.10 04.10					G1020920	23554 16,8 /WD/Acc/S LUC
<b>CITROEN DS3 Convertible (13-)</b>										
	1.2 PureTech VTi 82 1.6 e-HDi 90 1.6 THP 155 1.6 VTi 120	60 68 115 88		03.13 03.13 03.13 03.13					G2122194 G2126120	266 22,0 20,0 V +S +C 283 26,0 24,0 V +S +C
	1.6 THP 155 1.6 VTi 120	115 88		03.13 03.13					G1020920	23554 16,8 /WD/Acc/S LUC
<b>CITROEN DS4 (11-)</b>										
	1.6 e-HDi 110 1.6 HDi 110 1.6 HDi 115 1.6 HDi 90 1.6 THP 155 1.6 VTi 120 2.0 HDi 160	81 82 84 68 115 88 120		04.11 04.11 08.12 05.11 04.11 04.11 04.11					G1020790	24538 18,5 + ATE
	1.6 THP 160 2.0 HDi 135	120 100		04.12 09.11		- 19" wheel 1)			G1020792	24557 19,4 + ATE
	1.6 e-HDi 110 1.6 HDi 110 1.6 HDi 115 1.6 HDi 90 1.6 THP 155 1.6 VTi 120 2.0 HDi 160	81 82 84 68 115 88 120		04.11 04.11 08.12 05.11 04.11 04.11 04.11					G2126120	283 26,0 24,0 V +S +C
	1.6 e-HDi 110 1.6 HDi 110 1.6 HDi 115 1.6 HDi 90 1.6 THP 155 1.6 THP 160 1.6 THP 200 1.6 VTi 120 2.0 HDi 135 2.0 HDi 160	81 82 84 68 115 120 147 88 100 120		04.11 04.11 08.12 05.11 04.11 04.12 04.11 04.11 09.11 04.11					G1020946	24922 17,5 /Acc/S LUC

1) - ruota 19" / - roue 19" / - rueda 19" / - 19" Rad

2) + freno a mano elettrico / + frein à main électrique / + freno de mano eléctrico / + elektrische Feststellbremse



CITROEN DS5 (11-)																
	1.6 HDi 110	82	ORGA 13342	11.11		G1020792	hub diameter=82 <sup>1)</sup>	24557 19,4 +	ATE							
	1.6 HDi 115	84		08.12												
	1.6 THP 155	115		11.11												
	1.6 THP 200	147		11.11												
	2.0 HDi 135	100		11.11												
	2.0 HDi 135 Hybrid4	100		12.11												
	2.0 HDi 165	120		11.11												
	2.0 HDi 165 Hybr.4x4	120		12.11												
	2.0 HDi Hybrid4	147		11.11												
	1.6 HDi 110	82		ORGA 13343									G1020790	hub diameter=82 <sup>1)</sup>	24538 18,5 +	ATE
1.6 HDi 115	84	ORGA 13343														
	1.6 HDi 110	82	ORGA 13343			G2126120		283 26,0 24,0 V +S +C								
	1.6 HDi 115	84	ORGA 13343													
	1.6 HDi 110	82		11.11		G1020946		24922 17,5 /Acc/S	LUC							
	1.6 THP 155	115		11.11												
	1.6 THP 200	147		11.11												
	2.0 HDi 135	100		11.11												
	2.0 HDi 135 Hybrid4	100		12.11												
	2.0 HDi 165	120		11.11												
	2.0 HDi 165 Hybr.4x4	120		12.11												
	2.0 HDi Hybrid4	147		11.11												
	CITROEN EVASION (94-02)															
		1.8	73		05.97						07.02	G1020350		23042 19,0 /W/Acc	BDX	
1.8		76		02.96	12.96											
	1.9 i			10.95	12.98	G1020310		21801 19,0 +/W/S	LUC							
	1.9 TD			02.95	07.02											
	2.0 16V			12.98	07.02											
	2.0 HDi			08.99	07.02											
	2.0 i			06.94	07.02											
	2.0 Turbo			06.94	07.02											
	2.1 TD			05.96	07.02											
	1.8	73		05.97	07.02	G2120155		258 20,0 18,2 V L +C								
	1.8	76		02.96	12.96											
	1.8	73		05.97	07.02 + ABS	G1020291		21275 17,0 +/W	ATE							
	1.8	76		02.96	12.96 + ABS											
	1.9 i			10.95	12.98 + ABS											
	1.9 TD			02.95	07.02 + ABS											
	2.0 16V			12.98	07.02											
	2.0 HDi			08.99	07.02 + ABS											
	2.0 i			06.94	07.02 + ABS											
	2.0 Turbo			06.94	07.02											
	2.1 TD			05.96	07.02											
CITROEN JUMPER Bus (94-02)																
	1.9 D (10)	51		01.99	12.99	G1020301		21797 19,7 +/W/S	LUC							
	1.9 TD (10/14)	66		08.94	12.99											
	1.9 TD (10/14)	68		02.94	12.99											
	2.0 i (10/14)	80		02.94	12.99											
	2.5 D (14)	63		08.94	12.99											
	2.5 TD (14)	76		08.94	12.99											
	2.5 TDi (14)	79		12.96	12.99											
	1.9 D (10)	51		01.00	10.01	G1020482		23602 19,7 +/W/S	LUC							
	1.9 TD (10/14)	66		01.00	10.01											
	1.9 TD (10/14)	68		01.00	10.01											
	2.0 i (10/14)	80		01.00	10.01											
	2.5 D (14)	63		01.00	10.01											
	2.5 TD (14)	76		01.00	10.01											
	2.5 TDi (14)	79		01.00	11.00											
	2.8 HDi (14)	94		09.00	10.01											
	1.9 D (10)	51		11.01	03.02	G1020516		23917 19,3 +/W/Acc	BRE							
	1.9 TD (10/14)	66		11.01	03.02											
	1.9 TD (10/14)	68		11.01	03.02											
	2.0 i (10/14)	80		11.01	03.02											
	2.5 D (14)	63		11.01	03.02											
	2.5 TD (14)	76		11.01	03.02											
	2.8 HDi (14)	94		11.01	03.02											
	2.0 i (18)	80		02.94	12.99	G1020302		21799 19,7 +/W/S	LUC							
	2.5 D (18)	63		08.94	12.99											
	2.5 TD (18)	76		08.94	12.99											
	2.5 TDi (18)	79		12.96	12.99											
	2.0 i (18)	80		01.00	10.01	G1020483		23603 19,7 +/W/S	LUC							
	2.5 D (18)	63		01.00	10.01											
	2.5 TD (18)	76		01.00	10.01											
	2.5 TDi (18)	79		01.00	11.00											
	2.8 HDi (18)	94		09.00	10.01											
	2.0 i (18)	80		11.01	03.02	G1020517		23919 19,3 +/W/Acc	BRE							
	2.5 D (18)	63		11.01	03.02											
	2.5 TD (18)	76		11.01	03.02											
	2.8 HDi (18)	94		11.01	03.02											

<sup>1)</sup> diametro mozzo=82 / diamètre du moyeu=82 / diámetro del buje=82 / Naben D=82









**CITROEN JUMPER Bus (94-02)**

	1.9 D (10)	51		11.01	03.02	G2124127		280 24,0 21,9 V +C	
	1.9 TD (10/14)	66		11.01	03.02				
	1.9 TD (10/14)	68		11.01	03.02				
	2.0 i (10/14)	80		11.01	03.02				
	2.5 D (14)	63		11.01	03.02				
	2.5 TD (14)	76		08.94	03.02				
	2.5 TDi (14)	79		12.96	11.00				
	2.8 HDi (14)	94		09.00	03.02				
	2.0 i (18)	80		02.94	03.02	G2124138		300 24,0 21,9 V +C	
	2.5 D (18)	63		08.94	03.02				
	2.5 TD (18)	76		08.94	03.02				
	2.5 TDi (18)	79		12.96	11.00				
	2.8 HDi (18)	94		09.00	03.02				
	1.9 D (10)	51		11.01	03.02	G1020518		23921 20,3 /Acc	BRE
	1.9 TD (10/14)	66		11.01	03.02				
	1.9 TD (10/14)	68		11.01	03.02				
	2.0 i (10/14/18)	80		11.01	03.02				
	2.5 D (14/18)	63		11.01	03.02				
	2.5 TD (14/18)	76		11.01	03.02				
	2.8 HDi (14/18)	94		11.01	03.02				
	1.9 D (10)	51		11.01	03.02	G2116124		280 16,0 14,2 +C	
	1.9 TD (10/14)	66		11.01	03.02				
	1.9 TD (10/14)	68		11.01	03.02				
	2.0 i (10/14)	80		11.01	03.02				
	2.5 D (14)	63		11.01	03.02				
	2.5 TD (14)	76		11.01	03.02				
	2.8 HDi (14)	94		11.01	03.02				

**CITROEN JUMPER Van (94-02)**

	1.9 D (10)	50		07.99	12.99	G1020301		21797 19,7 +/W/S	LUC				
	1.9 D (10)	51		02.94	12.99								
	1.9 TD (10/14)	66		03.94	12.99								
	1.9 TD (10/14)	68		03.94	12.99								
	2.0 i (10/14)	80		03.94	12.99								
	2.5 D (14)	63		03.94	12.99								
	2.5 TD (14)	76		03.94	12.99								
	2.5 TDi (14)	79		12.96	12.99								
	1.9 D (10)	50		01.00	10.01	G1020482		23602 19,7 +/W/S	LUC				
	1.9 D (10)	51		01.00	10.01								
	1.9 TD (10/14)	66		01.00	10.01								
	1.9 TD (10/14)	68		01.00	10.01								
	2.0 i (10/14)	80		01.00	10.01								
	2.5 D (14)	63		01.00	10.01								
	2.5 TD (14)	76		01.00	10.01								
	2.5 TDi (14)	79		01.00	11.00								
	2.8 HDi (14)	94		09.00	10.01								
		1.9 D (10)	50		11.01					03.02	G1020516		23917 19,3 +/W/Acc
1.9 D (10)		51		11.01	03.02								
1.9 TD (10/14)		66		11.01	03.02								
1.9 TD (10/14)		68		11.01	03.02								
2.0 HDi (10/14)		62		11.01	03.02								
	2.0 i (10/14)	80		11.01	03.02	G1020302		21799 19,7 +/W/S	LUC				
	2.5 D (14)	63		03.94	12.99								
	2.5 TD (14)	76		03.94	12.99								
	2.5 TDi (14)	79		12.96	12.99								
	2.0 i (18)	80		01.00	10.01								
	2.5 D (18)	63		01.00	10.01								
	2.5 TD (18)	76		01.00	10.01								
	2.5 TDi (18)	79		01.00	11.00								
	2.8 HDi (18)	94		09.00	10.01	G1020483		23603 19,7 +/W/S	LUC				
	2.0 HDi (18)	62		11.01	03.02								
	2.0 i (18)	80		11.01	03.02								
	2.5 D (18)	63		11.01	03.02								
	2.5 TD (18)	76		11.01	03.02								
	2.5 TDi (18)	79		11.01	03.02	G1020517		23919 19,3 +/W/Acc	BRE				
	2.8 HDi (18)	94		11.01	03.02								
	1.9 D (10)	50		11.01	03.02					G2124127		280 24,0 21,9 V +C	
	1.9 D (10)	51		11.01	03.02								
	1.9 TD (10/14)	66		11.01	03.02								
1.9 TD (10/14)	68		11.01	03.02									
2.0 HDi (10/14)	62		11.01	03.02									
2.0 i (10/14)	80		11.01	03.02									
2.5 D (14)	63		11.01	03.02									
2.5 TD (14)	76		03.94	03.02									
	2.5 TDi (14)	79		12.96	11.00	G2124138		300 24,0 21,9 V +C					
	2.8 HDi (14)	94		09.00	03.02								
	2.0 HDi (18)	62		11.01	03.02								
	2.0 i (18)	80		11.01	03.02								
	2.5 D (18)	63		11.01	03.02								
	2.5 TD (18)	76		03.94	03.02								
	2.5 TDi (18)	79		12.96	11.00								
	2.8 HDi (18)	94		09.00	03.02								

	 kW								
<b>CITROEN JUMPER Van (94-02)</b>									
	1.9 D (10)	50		11.01	03.02	G1020518		23921 20,3 /Acc	BRE
	1.9 D (10)	51		11.01	03.02				
	1.9 TD (10/14)	66		11.01	03.02				
	1.9 TD (10/14)	68		11.01	03.02				
	2.0 HDi (10/14/18)	62		11.01	03.02				
	2.0 i (10/14/18)	80		11.01	03.02				
	2.5 D (14/18)	63		11.01	03.02				
	2.5 TD (14/18)	76		11.01	03.02				
	2.8 HDi (14/18)	94		11.01	03.02				
	1.9 D (10)	50		11.01	03.02	G2116124		280 16,0 14,2 +C	
	1.9 D (10)	51		11.01	03.02				
	1.9 TD (10/14)	66		11.01	03.02				
	1.9 TD (10/14)	68		11.01	03.02				
	2.0 HDi (10/14)	62		11.01	03.02				
	2.0 i (10/14)	80		11.01	03.02				
	2.5 D (14)	63		11.01	03.02				
	2.5 TD (14)	76		11.01	03.02				
	2.8 HDi (14)	94		11.01	03.02				
<b>CITROEN JUMPER Pickup/Chassis (94-02)</b>									
	1.9 TD (10/14)	66		03.94	12.99	G1020301		21797 19,7 +/W/S	LUC
	1.9 TD (10/14)	68		03.94	12.99				
	2.0 i (10/14)	80		03.94	12.99				
	2.5 D (14)	63		03.94	12.99				
	2.5 TD (14)	76		03.94	12.99				
	2.5 TDi (14)	79		12.96	12.99				
	1.9 TD (10/14)	66		01.00	10.01				
1.9 TD (10/14)	68		01.00	10.01					
2.0 i (10/14)	80		01.00	10.01					
2.5 D (14)	63		01.00	10.01					
2.5 TD (14)	76		01.00	10.01					
2.5 TDi (14)	79		01.00	10.01					
2.8 HDi (14)	94		09.00	10.01					
1.9 TD (10/14)	66		11.01	03.02	G1020516		23917 19,3 +/W/Acc	BRE	
1.9 TD (10/14)	68		11.01	03.02					
2.0 i (10/14)	80		11.01	03.02					
2.5 D (14)	63		11.01	03.02					
2.5 TD (14)	76		11.01	03.02					
2.5 TDi (14)	79		11.01	03.02					
2.8 HDi (14)	94		11.01	03.02					
2.0 i (18)	80		03.94	12.99	G1020302		21799 19,7 +/W/S	LUC	
2.5 D (18)	63		03.94	12.99					
2.5 TD (18)	76		03.94	12.99					
2.5 TDi (18)	79		12.96	12.99					
2.0 i (18)	80		01.00	10.01	G1020483		23603 19,7 +/W/S	LUC	
2.5 D (18)	63		01.00	10.01					
2.5 TD (18)	76		01.00	10.01					
2.5 TDi (18)	79		01.00	10.01					
2.8 HDi (18)	94		09.00	10.01					
2.0 i (18)	80		11.01	03.02	G1020517		23919 19,3 +/W/Acc	BRE	
2.5 D (18)	63		11.01	03.02					
2.5 TD (18)	76		11.01	03.02					
2.5 TDi (18)	79		11.01	03.02					
2.8 HDi (18)	94		11.01	03.02					
	1.9 TD (10/14)	66		11.01	03.02	G2124127		280 24,0 21,9 +C	
	1.9 TD (10/14)	68		11.01	03.02				
	2.0 i (10/14)	80		11.01	03.02				
	2.5 D (14)	63		11.01	03.02				
	2.5 TD (14)	76		03.94	03.02				
	2.5 TDi (14)	79		12.96	03.02				
	2.8 HDi (14)	94		09.00	03.02				
2.0 i (18)	80		03.94	03.02	G2124138		300 24,0 21,9 V +C		
2.5 D (18)	63		03.94	03.02					
2.5 TD (18)	76		03.94	03.02					
2.5 TDi (18)	79		12.96	03.02					
2.8 HDi (18)	94		09.00	03.02					
	1.9 TD (10/14)	66		11.01	03.02	G1020518		23921 20,3 /Acc	BRE
	1.9 TD (10/14)	68		11.01	03.02				
	2.0 i (10/14/18)	80		11.01	03.02				
	2.5 D (14/18)	63		11.01	03.02				
	2.5 TD (14/18)	76		11.01	03.02				
	2.5 TDi (14/18)	79		11.01	03.02				
	2.8 HDi (14/18)	94		11.01	03.02				
	1.9 TD (10/14)	66		11.01	03.02	G2116124		280 16,0 14,2 +C	
	1.9 TD (10/14)	68		11.01	03.02				
	2.0 i (10/14)	80		11.01	03.02				
	2.5 D (14)	63		11.01	03.02				
	2.5 TD (14)	76		11.01	03.02				
	2.5 TDi (14)	79		11.01	03.02				
	2.8 HDi (14)	94		11.01	03.02				





















		kW																		
<b>CITROEN JUMPER (02-06)</b>																				
	2.0 HDi (10/14)	62		04.02	03.06	payload 1000 KG / 1400 KG <sup>1)</sup>	G1020516				23917	19,3 +/W/Acc	BRE							
	2.0 i (10/14)	81		04.02	03.06															
	2.2 HDi (10/14)	74		04.02	03.06															
	2.8 HDi (10/14)			04.02	03.06															
	2.8 HDi 4x4(10/14/18)			04.02	03.06															
	2.0 HDi (18)	62		04.02	03.06	payload 1800 KG <sup>2)</sup>	G1020517				23919	19,3 +/W/Acc	BRE							
	2.0 i (18)	81		04.02	03.06															
	2.2 HDi (18)	74		04.02	03.06															
	2.8 HDi (18)			04.02	03.06															
	2.8 HDi 4x4(10/14/18)			04.02	03.06															
	2.0 HDi (10/14)	62		04.02	03.06	payload 1000 KG / 1400 KG <sup>1)</sup>	G2124127				280	24,0 21,9 V +C								
	2.0 i (10/14)	81		04.02	03.06															
	2.2 HDi (10/14)	74		04.02	03.06															
	2.8 HDi (10/14)			04.02	03.06															
	2.8 HDi 4x4(10/14/18)			04.02	03.06															
	2.0 HDi (18)	62		04.02	03.06	payload 1800 KG <sup>2)</sup>	G2124138				300	24,0 21,9 V +C								
	2.0 i (18)	81		04.02	03.06															
	2.2 HDi (18)	74		04.02	03.06															
	2.8 HDi (18)			04.02	03.06															
	2.8 HDi 4x4(10/14/18)			04.02	03.06															
	2.0 HDi (10/14/18)	62		04.02	03.06		G1020518				23921	20,3 /Acc	BRE							
	2.0 i (10/14/18)	81		04.02	03.06															
	2.2 HDi (10/14/18)	74		04.02	03.06															
	2.8 HDi (10/14/18)			04.02	03.06															
	2.8 HDi 4x4(10/14/18)			04.02	03.06															
	2.0 HDi (10/14)	62		04.02	03.06	payload 1000 KG / 1400 KG <sup>1)</sup>	G2116124				280	16,0 14,2 +C								
	2.0 i (10/14)	81		04.02	03.06															
	2.2 HDi (10/14)	74		04.02	03.06															
	2.8 HDi (10/14)			04.02	03.06															
	2.8 HDi 4x4(10/14/18)			04.02	03.06															
<b>CITROEN JUMPER (06-)</b>																				
	2.2 HDi 100	74		04.06	payload 120/140 <sup>3)</sup>	G1020763					24468	19,1 +/W/Acc	BRE							
	2.2 HDi 110	81		07.11	payload 120/140 <sup>3)</sup>															
	2.2 HDi 120	88		04.06	payload 120/140 <sup>3)</sup>															
	2.2 HDi 130	96		07.11	payload 120/140 <sup>3)</sup>															
	2.2 HDi 150	110		07.11	payload 120/140 <sup>3)</sup>															
	3.0 HDi 145	107		07.10	payload 120/140 <sup>3)</sup>															
	3.0 HDi 155	115		07.10	payload 120/140 <sup>3)</sup>															
	3.0 HDi 160	116		09.06	payload 120/140 <sup>3)</sup>															
	3.0 HDi 180	130		07.11	payload 120/140 <sup>3)</sup>															
	2.2 HDi 100	74		04.06	light payload 160 <sup>4)</sup>									G1020872				24468	19,1 +/W/Acc	BRE
	2.2 HDi 110	81		07.11	light payload 160 <sup>4)</sup>															
	2.2 HDi 120	88		04.06	light payload 160 <sup>4)</sup>															
	2.2 HDi 130	96		07.11	light payload 160 <sup>4)</sup>															
	2.2 HDi 150	110		07.11	light payload 160 <sup>4)</sup>															
3.0 HDi 145	107		07.10	light payload 160 <sup>4)</sup>																
3.0 HDi 155	115		07.10	light payload 160 <sup>4)</sup>																
3.0 HDi 160	116		09.06	light payload 160 <sup>4)</sup>																
3.0 HDi 180	130		07.11	light payload 160 <sup>4)</sup>																
2.2 HDi 100	74		04.06	heavy payload 160 <sup>5)</sup>	G1020764				24466	19,1 +/W/Acc	BRE									
2.2 HDi 110	81		07.11	heavy payload 160 <sup>5)</sup>																
2.2 HDi 120	88		04.06	heavy payload 160 <sup>5)</sup>																
2.2 HDi 130	96		07.11	heavy payload 160 <sup>5)</sup>																
2.2 HDi 150	110		07.11	heavy payload 160 <sup>5)</sup>																
3.0 HDi 145	107		07.10	heavy payload 160 <sup>5)</sup>																
3.0 HDi 155	115		07.10	heavy payload 160 <sup>5)</sup>																
3.0 HDi 160	116		09.06	heavy payload 160 <sup>5)</sup>																
3.0 HDi 180	130		07.11	heavy payload 160 <sup>5)</sup>																
2.2 HDi 100	74		04.06	payload 200 <sup>6)</sup>								G1020873				24466	19,1 +/W/Acc	BRE		
2.2 HDi 110	81		07.11	payload 200 <sup>6)</sup>																
2.2 HDi 120	88		04.06	payload 200 <sup>6)</sup>																
2.2 HDi 130	96		07.11	payload 200 <sup>6)</sup>																
2.2 HDi 150	110		07.11	payload 200 <sup>6)</sup>																
3.0 HDi 145	107		07.10	payload 200 <sup>6)</sup>																
3.0 HDi 155	115		07.10	payload 200 <sup>6)</sup>																
3.0 HDi 160	116		09.06	payload 200 <sup>6)</sup>																
3.0 HDi 180	130		07.11	payload 200 <sup>6)</sup>																
	2.2 HDi 100	74		04.06	payload 120/140 <sup>3)</sup>	G2124127					280								24,0 21,9 V +C	
	2.2 HDi 110	81		07.11	payload 120/140 <sup>3)</sup>															
	2.2 HDi 120	88		04.06	payload 120/140 <sup>3)</sup>															
	2.2 HDi 130	96		07.11	payload 120/140 <sup>3)</sup>															
	2.2 HDi 150	110		07.11	payload 120/140 <sup>3)</sup>															
	3.0 HDi 145	107		07.10	payload 120/140 <sup>3)</sup>															
	3.0 HDi 155	115		07.10	payload 120/140 <sup>3)</sup>															
	3.0 HDi 160	116		09.06	payload 120/140 <sup>3)</sup>															
	3.0 HDi 180	130		07.11	payload 120/140 <sup>3)</sup>															
	2.2 HDi 100	74		04.06	heavy payload 160 <sup>5)</sup>							G2124138				300	24,0 21,9 V +C			
	2.2 HDi 110	81		07.11	heavy payload 160 <sup>5)</sup>															
	2.2 HDi 120	88		04.06	heavy payload 160 <sup>5)</sup>															
	2.2 HDi 130	96		07.11	heavy payload 160 <sup>5)</sup>															
	2.2 HDi 150	110		07.11	heavy payload 160 <sup>5)</sup>															
3.0 HDi 145	107		07.10	heavy payload 160 <sup>5)</sup>																
3.0 HDi 155	115		07.10	heavy payload 160 <sup>5)</sup>																
3.0 HDi 160	116		09.06	heavy payload 160 <sup>5)</sup>																
3.0 HDi 180	130		07.11	heavy payload 160 <sup>5)</sup>																

<sup>1)</sup> carico utile 1000 KG / 1400 KG / charge utile 1000 KG / 1400 KG / carga útil 1000 KG / 1400 KG / Nutzlast 1000 KG / 1400 KG  
<sup>2)</sup> carico utile 1800 KG / charge utile 1800 KG / carga útil 1800 KG / Nutzlast 1800 KG  
<sup>3)</sup> carico utile 120/140 / charge utile 120/140 / carga útil 120/140 / Nutzlast 120/140  
<sup>4)</sup> carico utile leggero 160 / charge utile légère 160 / carga útil ligera 160 / Nutzlast leicht 160  
<sup>5)</sup> carico utile pesante 160 / charge utile lourde 160 / carga útil pesada 160 / Nutzlast schwer 160  
<sup>6)</sup> carico utile 200 / charge utile 200 / carga útil 200 / Nutzlast 200





















<b>CITROEN JUMPER (06-)</b>									
	2.2 HDi 100 2.2 HDi 110 2.2 HDi 120 2.2 HDi 130 2.2 HDi 150 3.0 HDi 145 3.0 HDi 155 3.0 HDi 160 3.0 HDi 180	74 81 88 96 110 107 115 116 130		04.06 07.11 04.06 07.11 07.11 07.10 07.10 09.06 07.11			G1020730		24465 19,2 /Acc/S BRE
	2.2 HDi 100 2.2 HDi 110 2.2 HDi 120 2.2 HDi 130 2.2 HDi 150 3.0 HDi 145 3.0 HDi 155 3.0 HDi 160 3.0 HDi 180	74 81 88 96 110 107 115 116 130		04.06 07.11 04.06 07.11 07.11 07.10 07.10 09.06 07.11	payload 120/14Q+ light 16Q <sup>1)</sup> payload 120/14Q+ light 16Q <sup>1)</sup> payload 120/14Q+ light 16Q <sup>1)</sup> payload 120/14Q+ light 16Q <sup>1)</sup> payload 120/14Q+ light 16Q <sup>1)</sup> payload 120/14Q+ light 16Q <sup>1)</sup> payload 120/14Q+ light 16Q <sup>1)</sup> payload 120/14Q+ light 16Q <sup>1)</sup> payload 120/14Q+ light 16Q <sup>1)</sup>		G2116124		280 16,0 14,2 +C
	2.2 HDi 100 2.2 HDi 110 2.2 HDi 120 2.2 HDi 130 2.2 HDi 150 3.0 HDi 145 3.0 HDi 155 3.0 HDi 160 3.0 HDi 180	74 81 88 96 110 107 115 116 130		04.06 07.11 04.06 07.11 07.11 07.10 07.10 09.06 07.11	payload 20Q <sup>2)</sup> payload 20Q <sup>2)</sup> payload 20Q <sup>2)</sup> payload 20Q <sup>2)</sup> payload 20Q <sup>2)</sup> payload 20Q <sup>2)</sup> payload 20Q <sup>2)</sup> payload 20Q <sup>2)</sup> payload 20Q <sup>2)</sup>		G2116123		300 16,0 14,2 +C
<b>CITROEN JUMPY Estate (95-06)</b>									
	1.6 1.9 D 1.9 TD 1.9 TD 2.0 16V 2.0 16V 2.0 HDi 2.0 HDi	51 66 68 100 102 69 80	ORGA 09792 ORGA 09155 ORGA 09792 ORGA 09792 ORGA 09792 ORGA 09792 ORGA 09792 ORGA 09155	10.95 10.95 10.95 04.96 04.00 03.00 10.99 03.00			G1020310		21801 19,0 +/-W/S LUC
	1.6 1.9 D	51	ORGA 09155 ORGA 09156	10.95 12.06			G1020350		23042 19,0 /W/Acc BDX
	1.6 1.9 TD 2.0 16V 2.0 16V 2.0 HDi 2.0 HDi	66 100 102 69 80	ORGA 09793 ORGA 09793 ORGA 09793 ORGA 09793 ORGA 09793 ORGA 09793	12.06 12.06 12.06 12.06 12.06 12.06			G1020514		20261 19,0 +/-W/S LUC
	1.6 1.9 D 1.9 TD 1.9 TD 2.0 16V 2.0 16V 2.0 HDi 2.0 HDi	51 66 68 100 102 69 80	ORGA 09155 ORGA 09155 ORGA 09155 ORGA 09155 ORGA 09155 ORGA 09155 ORGA 09155 ORGA 09155	10.95 10.95 10.95 04.96 04.00 03.00 10.99 03.00			G2120155		258 20,0 18,2 V L +C
<b>CITROEN JUMPY Van (95-06)</b>									
	1.6 1.9 D 1.9 D 70 1.9 TD 2.0 16V 2.0 HDi 110 2.0 HDi 95	51 51 66 102 80 69	ORGA 09792 ORGA 09155 ORGA 09155 ORGA 09155 ORGA 09792 ORGA 09792 ORGA 09792	10.95 10.95 04.98 10.95 03.00 01.02 10.99	+ 0,8/0,9 t + 0,8/0,9 t + 0,8/0,9 t + 0,8/0,9 t + 0,8/0,9 t + 0,8/0,9 t + 0,8/0,9 t		G1020350 G1020310		23042 19,0 /W/Acc 21801 19,0 +/-W/S BDX LUC
	1.9 D 1.9 D 70 1.9 TD	51 51 66	ORGA 09156 ORGA 09156 ORGA 09156	12.06 12.06 12.06	+ 0,8/0,9 t + 0,8/0,9 t + 0,8/0,9 t		G1020350		23042 19,0 /W/Acc BDX
	1.6 2.0 16V 2.0 HDi 110 2.0 HDi 95	102 80 69	ORGA 09793 ORGA 09793 ORGA 09793	12.06 12.06 12.06	+ 0,8/0,9 t + 0,8/0,9 t + 0,8/0,9 t		G1020514		20261 19,0 +/-W/S LUC
	1.6 1.9 D 70 1.9 TD 2.0 16V 2.0 HDi 110 2.0 HDi 95	51 66 102 80 69	ORGA 09155 ORGA 09155 ORGA 09155 ORGA 09155 ORGA 09155 ORGA 09155	10.95 04.98 10.95 03.00 01.02 10.99	+ 0,8 t + 0,8 t + 0,8 t + 0,8 t + 0,8 t + 0,8 t		G2120155		258 20,0 18,2 V L +C
<b>CITROEN JUMPY Pickup/Chassis (99-06)</b>									
	1.9 TD 2.0 HDi	68 69	ORGA 09792 ORGA 09792	10.99 10.99			G1020310		21801 19,0 +/-W/S LUC
	1.9 TD 2.0 HDi	68 69	ORGA 09793 ORGA 09793	12.06 12.06			G1020514		20261 19,0 +/-W/S LUC

<sup>1)</sup> carico utile 120/14Q+ leggero 16Q / charge utile 120/14Q+ légère 16Q / carga útil 120/14Q+ ligera 16Q / Nutzlast 120/14Q+ leicht 16Q

<sup>2)</sup> carico utile 20Q / charge utile 20Q / carga útil 20Q / Nutzlast 20Q

							
<b>CITROEN JUMPY (07-)</b>							
	1.6 HDi 90	66		01.07		G1020937	24595 18,5 +/W/Acc/S LUC
	2.0 HDi 120	88		01.07			
	2.0 HDi 125	94		07.11			
	2.0 HDi 140	100		01.07			
	2.0 HDi 165	120		07.10			
	2.0 HDi 95	72		07.11			
	2.0 i	103		01.07			
	1.6 HDi 90	66		01.07	+ long wheel base <sup>1)</sup>	G1020938	24578 16,5 /Acc/S LUC
	2.0 HDi 120	88		01.07			
	2.0 HDi 125	94		07.11			
	2.0 HDi 140	100		01.07			
	2.0 HDi 165	120		07.10			
	2.0 HDi 95	72		07.11			
	2.0 i	103		01.07			
<b>CITROEN NEMO (08-)</b>							
	1.4 HDi	50		02.08		G1020740	23706 18,0 +/W/S BOS
	1.4 i	54		02.08			
	1.3 HDi 75	55		10.10		G1201224	
	1.4 HDi	50		02.08	+ autom.manual transmission <sup>2)</sup>	G2122147	23706 18,0 +/W/Acc/S BOS
	1.3 HDi 75	55		10.10		G2122197	
	1.4 HDi	50		02.08	+ manual transmission <sup>3)</sup>		
	1.4 i	54		02.08			
	1.4 i	54		02.08			
<b>CITROEN SAXO (96-04)</b>							
	1.0 i			02.96	03.04	G1020443	21857 17,7 ATE
	1.1 X/SX			02.96	03.04	G1020215	
	1.4 i VTS	55		02.96	03.04	G1020215	
	1.5 D			04.96	03.04		
	1.5 D	43		07.01	04.04		
	1.4 i VTS	55		05.96	03.04	G1020293	
	1.6	66		02.96	06.03		
	1.6	74		02.01	04.04		
	1.6	88		02.96	04.04		
	1.0 i			02.96	03.04	G2108107	238 8,0 6,0 +S +C ATE
	1.1 X/SX			02.96	03.04	G2110187	
	1.4 i VTS	55		02.96	03.04	G2110187	
	1.5 D			04.96	03.04		
	1.5 D	43		07.01	04.04		
	1.4 i VTS	55		05.96	03.04	G2120132	
	1.6	66		02.96	06.03	G2120132	
	1.6	74		02.01	04.04		
	1.6	88		02.96	04.04		
	1.6 16V VTS	87		07.96	03.04		20974 10,7 BDX
	1.6 i	65		02.96	03.04		
	1.6 i VTS	72		09.00	03.04		
	1.6	66		02.96	06.03	G1020522	
	1.6	74		02.01	04.04		
	1.6	88		02.96	04.04		
	1.6 16V VTS	87		07.96	03.04		
	1.6 i VTR	65		02.96	03.04		
	1.6 i VTS	72		09.00	03.04		
	1.6	66		02.96	06.03	G2108106	247 8,0 6,0 +S +C
	1.6	74		02.01	04.04		
	1.6	88		02.96	04.04		
	1.6 16V VTS	87		07.96	03.04		
	1.6 i VTR	65		02.96	03.04		
	1.6 i VTS	72		09.00	03.04		
	1.6	66		02.96	06.03		
	1.6	74		02.01	04.04		
	1.6	88		02.96	04.04		
<b>CITROEN XANTIA (X1) Saloon (93-97)</b>							
	1.6 i	65		03.93	12.97	G1020328	21631 17,0 /W/ BDX
	1.8 16V	81		06.95	12.97		
	1.8 i	66		04.97	12.97		
	1.8 i	74		03.93	12.97		
	1.9 D	50		06.94	12.97		
	1.9 D	51		06.94	12.97		
	1.9 SD	55		02.96	12.97		
	1.9 TD	66		10.94	12.97		
	2.0	95		03.93	05.95		
	2.0 16V	97		06.95	12.97		
	2.0 16V	110		06.94	12.97		
	2.0 16V	112		03.93	12.97		
	2.0 i	89		03.93	12.97		
		1.6 i	65		03.93	12.97	
1.8 16V		81		06.95	12.97		
1.8 i		66		04.97	12.97		
1.8 i		74		03.93	12.97		
1.9 D		50		06.94	12.97		
1.9 D		51		06.94	12.97		
1.9 SD		55		02.96	12.97		
1.9 TD		66 ORGA 07568			12.97		
2.0 i		89		03.93	12.97		

1) + passo lungo / + empattement long / + distancia larga entre ejes / + langer Radstand  
2) + scatola camb.velocità autom. / + transm.mécanique autom. / + cambio de velocidad autom. / + automatisiertes Schaltgetriebe  
3) + scatola cambio velocità / + transmission mécanique / + cambio de velocidad / + Schaltgetriebe  
4) per cerchione a 3 fori / pour jante à 3 trous / para Liantas de 3 taladros / für 3-Loch-Felge  
5) per cerchione a 4 fori / pour jante à 4 trous / para Liantas de 4 taladros / für 4-Loch-Felge

							
<b>CITROEN XANTIA (X1) Saloon (93-97)</b>							
	2.0 Turbo 2.1 TD	108 80		06.95 06.95	12.97 12.97	G2126106	283 26,0 24,2 V +S +C
	1.6 i 1.8 16V 1.8 i 1.8 i 1.9 D 1.9 D 1.9 SD 1.9 TD 2.0 2.0 16V 2.0 16V 2.0 16V 2.0 i 2.0 Turbo 2.1 TD 3.0 V6	65 81 66 74 50 51 55 66 95 97 110 112 89 108 80 140		03.93 06.95 04.97 03.93 06.94 06.94 02.96 10.94 03.93 06.95 06.94 03.93 03.93 06.95 06.95 01.97	12.97 12.97 12.97 12.97 12.97 12.97 12.97 12.97 05.95 12.97 12.97 12.97 12.97 12.97 12.97 12.97	G1020329	20162 15,4 CIT
<b>CITROEN XANTIA (X1) Estate (95-97)</b>							
	1.8 16V 1.8 i 1.8 i 1.8 i	81 66 74 ORGA 07483 74		06.95 04.97 12.97 06.95	12.97 12.97 + ABS - ABS	G1020328	21631 17,0 /WI BDX
	1.8 16V 1.8 16V 1.8 i 1.8 i 2.0 Turbo 2.1 TD	81 ORGA 07483 81 66 74 ORGA 07483 74 108 80		06.95 04.97 06.95 06.95 06.95 06.96	12.97 + ABS - ABS 12.97 + ABS - ABS 12.97 12.97	G2120133 G2126106	266 20,5 18,5 V +S +C 283 26,0 24,2 V +S +C
<b>CITROEN XANTIA (X2) Saloon (98-03)</b>							
	1.8 16V 1.8 i 1.9 SD 1.9 TD 2.0 HDi 90	81 66 55 66 66		01.98 01.98 01.98 01.98 03.99	09.01 09.01 09.01 09.01 04.03	G1020328	21631 17,0 /WI BDX
	1.8 16V 1.8 i 1.9 SD 1.9 TD 2.0 HDi 90 2.0 16V ACTIVA 2.0 Turbo 2.1 TD	81 66 55 66 66 97 108 80		01.98 01.98 01.98 01.98 03.99 01.98 01.98 01.98	09.01 09.01 09.01 09.01 04.03 09.01 09.01 09.01	G2120133 G2126106	266 20,5 18,5 V +S +C 283 26,0 24,2 V +S +C
	1.8 16V 1.8 i 1.9 SD 1.9 TD 2.0 16V 2.0 HDi 110 2.0 HDi 90 2.0 i 2.0 Turbo 2.1 TD 3.0 V6	81 66 55 66 97 109 66 89 108 80 140		01.98 01.98 01.98 01.98 01.98 02.99 03.99 01.98 01.98 01.98 01.98	09.01 09.01 09.01 09.01 09.01 09.01 09.01 09.01 09.01 02.99 09.01	G1020329	20162 15,4 CIT
<b>CITROEN XANTIA (X2) Estate (98-03)</b>							
	1.8 16V 1.8 i	81 66		01.98 01.98	09.01 09.01	G1020328	21631 17,0 /WI BDX
	1.8 16V 1.8 i 2.0 Turbo 2.1 TD	81 66 108 80		01.98 01.98 01.98 01.98	09.01 09.01 09.01 09.01	G2120133 G2126106	266 20,5 18,5 V +S +C 283 26,0 24,2 V +S +C
	2.0 i	89		01.98	09.01	G1020329	20162 15,4 CIT
<b>CITROEN XM (Y3) Saloon (89-94)</b>							
	2.0 2.0 i 2.0 Turbo 2.1 D 2.1 TD 3.0 24V 3.0 V6	84 89 104 60 80 147 123		05.89 05.89 09.92 05.89 05.89 07.90 05.89	04.94 06.94 06.94 06.94 06.94 06.94 06.94	G1020329	20162 15,4 CIT
<b>CITROEN XM (Y4) Saloon (94-00)</b>							
	2.0 16V 2.0 Turbo 2.1 TD 2.5 TD 3.0 24V	97 108 80 95 147		05.94 05.94 05.94 05.94 05.94	10.00 10.00 10.00 10.00 10.00	G1020329	20162 15,4 CIT

1) + scatola cambio velocità / + transmission mécanique / + cambio de velocidad / + Schaltgetriebe

### CITROEN XM (Y4) Saloon (94-00)

	3.0 V6	123		05.94	10.00		G1020329			20162 15,4	CIT
	3.0 V6	140		04.97	10.00						

### CITROEN XSARA (N1) Saloon (97-05)

	1.4 i	55		04.97	08.00	- ABS	G1020497			21980 18,0 +/WD/S	BOS
	1.5 D	42		04.97	08.00	- ABS					
	1.4 i	55		04.97	08.00	+ ABS	G1020293			21827 17,3 +	ATE
	1.5 D	42		04.97	08.00	+ ABS					
	1.6 i	65		04.97	08.00						
	1.8 D	43		04.97	08.00						
	1.8 i	66		04.97	08.00						
	1.8 i	74		04.97	08.00	-					
	1.8 TD	66		10.97	08.00						
	1.9 D	50		04.97	08.00						
	1.9 D	51		07.98	08.00						
	1.9 SD	55		01.98	08.00						
	1.9 TD	66		04.97	08.00						
	1.8 16V	81		04.97	08.00		G1020513			23332 18,0 +/W/S	BOS
	1.8 i	74		04.97	08.00	+	G1020451			23124 19,0 +/W/S	LUC
	2.0 16V	97		07.98	08.00						
	2.0 HDi 90	66		02.99	08.00						
	2.0 16V	100	ORGA 09184	09.00			G1020363			21674 19,0 +/W/S	LUC
	2.0 16V	120	ORGA 09184	04.97							
	2.0 HDi 110	80	ORGA 09184	05.01							
	2.0 16V	100	ORGA 09185		03.05		G1020735			23600 19,4 /Acc/S	BOS
	2.0 16V	120	ORGA 09185		03.05						
	2.0 HDi 110	80	ORGA 09185		03.05						
	1.4 i	55		04.97	08.00	- ABS	G2113185			248 13,0 11,0 +S +C	
	1.5 D	42		04.97	08.00	- ABS					
	1.4 i	55		04.97	08.00	+ ABS	G2120132			247 20,4 18,5 V +S +C	
	1.5 D	42		04.97	08.00	+ ABS					
	1.6 i	65		04.97	08.00						
	1.8 D	43		04.97	08.00						
	1.8 i	66		04.97	08.00						
	1.8 i	74		04.97	08.00	-					
	1.8 TD	66		10.97	08.00						
	1.9 D	50		04.97	08.00						
	1.9 D	51		07.98	08.00						
	1.9 SD	55		01.98	08.00						
	1.9 TD	66		04.97	08.00						
	1.8 16V	81		04.97	08.00		G2120133			266 20,5 18,5 V +S +C	
	1.8 i	74		04.97	08.00	+					
	2.0 16V	97		07.98	08.00						
	2.0 HDi 90	66		02.99	08.00						
	1.4 HDi 70	50		01.03	03.05		G2122194			266 22,0 20,0 V +S +C	
	1.4 i	55		09.00	03.05						
	1.6 16V	80		09.00	03.05						
	1.9 D	51		09.00	03.05						
	2.0 HDi 90	66		09.00	03.05						
	2.0 16V	100	ORGA 09185		03.05		G2126120			283 26,0 24,0 V +S +C	
	2.0 16V	120	ORGA 09185		03.05						
	2.0 HDi 110	80	ORGA 09185		03.05						
	1.6 16V	80		09.00	03.05		G1020522			20974 10,7	BDX
	1.8 16V	81		04.97	09.00						
	1.8 i	74		04.97	09.00	+					
	2.0 16V	97		07.98	09.00						
	2.0 16V	100		09.00	03.05						
	2.0 16V	120		04.97	09.00						
	2.0 HDi 110	80		05.01	03.05						
	2.0 HDi 90	66		02.99	03.05						
	1.6 16V	80		09.00	03.05		G2108106			247 8,0 6,0 +S +C	
	1.8 16V	81		04.97	08.00						
	1.8 i	74		04.97	08.00	+					
	2.0 16V	97		07.98	08.00						
	2.0 16V	100		09.00	03.05						
	2.0 16V	120		04.97	08.00						
	2.0 HDi 110	80		05.01	03.05						
	2.0 HDi 90	66		02.99	03.05						

### CITROEN XSARA (N2) Estate (97-05)

	1.4 i	55		10.97	08.00	- ABS	G1020293			21827 17,3 +	ATE
	1.5 D	42		10.97	08.00	- ABS					
	1.6 i	65		10.97	08.00	- ABS					
	1.8 D	43		10.97	08.00	- ABS					
	1.9 D	50		10.97	08.00	- ABS					
	1.9 D	51		07.98	08.00	- ABS					
	1.4 i	55		10.97	08.00	+ ABS	G1020513			23332 18,0 +/W/S	BOS
	1.5 D	42		10.97	08.00	+ ABS	G1020451			23124 19,0 +/W/S	LUC
	1.6 i	65		10.97	08.00	+ ABS					
	1.8 16V	81		10.97	08.00						
	1.8 D	43		10.97	08.00	+ ABS					
	1.8 i	66		10.97	08.00						
	1.8 i	74		10.97	08.00						
	1.9 D	50		10.97	08.00	+ ABS					



**CITROEN XSARA (N2) Estate (97-05)**

	1.9 D	51		<b>07.98</b>	<b>08.00</b>	+ ABS	<b>G1020513</b> <b>G1020451</b>		23332 18,0 +/W/S 23124 19,0 +/W/S	<b>BOS</b> <b>LUC</b>			
	1.9 SD	55		<b>01.98</b>	<b>08.00</b>								
	1.9 TD	66		<b>10.97</b>	<b>08.00</b>								
	2.0 16V	97		<b>07.98</b>	<b>08.00</b>								
	2.0 HDi 90	66		<b>09.98</b>	<b>08.00</b>								
	2.0 16V	100	ORGA 09184	<b>09.00</b>			<b>G1020363</b>		21674 19,0 +/W/S	<b>LUC</b>			
	2.0 HDi 110	80	ORGA 09184	<b>05.01</b>									
	2.0 16V	100	ORGA 09185				<b>G1020735</b>		23600 19,4 /Acc/S	<b>BOS</b>			
	2.0 HDi 110	80	ORGA 09185										
	1.4 i	55		<b>10.97</b>	<b>08.00</b>	- ABS	<b>G2120132</b> <b>G2124127</b>		247 20,4 18,5 V +S +C 280 24,0 21,9 V +C				
	1.5 D	42		<b>10.97</b>	<b>08.00</b>	- ABS							
	1.6 i	65		<b>10.97</b>	<b>08.00</b>	- ABS							
	1.8 D	43		<b>10.97</b>	<b>08.00</b>	- ABS							
	1.9 D	50		<b>10.97</b>	<b>08.00</b>	- ABS							
	1.9 D	51		<b>07.98</b>	<b>08.00</b>	- ABS							
	1.4 i	55		<b>10.97</b>	<b>08.00</b>	+ ABS	<b>G2120133</b>		266 20,5 18,5 V +S +C				
	1.5 D	42		<b>10.97</b>	<b>08.00</b>	+ ABS							
	1.6 i	65		<b>10.97</b>	<b>08.00</b>	+ ABS							
	1.8 16V	81		<b>10.97</b>	<b>08.00</b>	+ ABS							
	1.8 D	43		<b>10.97</b>	<b>08.00</b>	+ ABS							
	1.8 i	66		<b>10.97</b>	<b>08.00</b>	+ ABS							
	1.8 i	74		<b>10.97</b>	<b>08.00</b>	+ ABS							
	1.9 D	50		<b>10.97</b>	<b>08.00</b>	+ ABS							
	1.9 D	51		<b>07.98</b>	<b>08.00</b>	+ ABS							
1.9 SD	55		<b>01.98</b>	<b>08.00</b>									
1.9 TD	66		<b>10.97</b>	<b>08.00</b>									
2.0 16V	97		<b>07.98</b>	<b>08.00</b>									
2.0 HDi 90	66		<b>09.98</b>	<b>08.00</b>									
1.4 HDi 70	50		<b>01.03</b>	<b>08.05</b>		<b>G2122194</b>						266 22,0 20,0 V +S +C	
1.4 i	55		<b>09.00</b>	<b>08.05</b>									
1.6 16V	80		<b>09.00</b>	<b>08.05</b>									
1.9 D	51		<b>09.00</b>	<b>08.05</b>									
2.0 HDi 90	66		<b>09.00</b>	<b>08.05</b>									
2.0 16V	100	ORGA 09185				<b>G2126120</b>		283 26,0 24,0 V +S +C					
2.0 HDi 110	80	ORGA 09185											
	1.6 16V	80		<b>09.00</b>	<b>08.05</b>		<b>G1020522</b>		20974 10,7	<b>BDX</b>			
	1.8 16V	81		<b>10.97</b>	<b>08.00</b>								
	1.8 i	74		<b>10.97</b>	<b>08.00</b>	+ (BR)							
	2.0 16V	97		<b>07.98</b>	<b>08.00</b>								
	2.0 16V	100		<b>09.00</b>	<b>08.05</b>								
	2.0 HDi 110	80		<b>05.01</b>	<b>08.05</b>								
	2.0 HDi 90	66		<b>09.98</b>	<b>08.05</b>								
	1.6 16V	80		<b>09.00</b>	<b>08.05</b>		<b>G2108106</b>		247 8,0 6,0 +S +C				
	1.8 16V	81		<b>10.97</b>	<b>08.00</b>								
	1.8 i	74		<b>10.97</b>	<b>08.00</b>	+ (BR)							
	2.0 16V	97		<b>07.98</b>	<b>08.00</b>								
	2.0 16V	100		<b>09.00</b>	<b>08.05</b>								
	2.0 HDi 110	80		<b>05.01</b>	<b>08.05</b>								
	2.0 HDi 90	66		<b>09.98</b>	<b>08.05</b>								

**CITROEN XSARA (N0) Coupe (97-05)**

	1.4 i	55		<b>02.98</b>	<b>08.00</b>	- ABS	<b>G1020497</b>		21980 18,0 +/WD/S	<b>BOS</b>
	1.4 i	55		<b>02.98</b>	<b>08.00</b>	+ ABS				
	1.6 i	65		<b>02.98</b>	<b>08.00</b>					
	1.8 i	66		<b>02.98</b>	<b>08.00</b>					
	1.8 i	74		<b>04.97</b>	<b>08.00</b>	- (BR)				
	1.9 D	50		<b>02.98</b>	<b>08.00</b>					
	1.9 D	51		<b>02.98</b>	<b>08.00</b>					
	1.9 TD	66		<b>02.98</b>	<b>08.00</b>					
	1.8 16V	81		<b>02.98</b>	<b>08.00</b>		<b>G1020513</b> <b>G1020451</b>		23332 18,0 +/W/S 23124 19,0 +/W/S	<b>BOS</b> <b>LUC</b>
	1.8 i	74		<b>04.97</b>	<b>08.00</b>	+ (BR)				
2.0 HDi 90	66		<b>02.99</b>	<b>08.00</b>						
2.0	97	ORGA 09184	<b>08.98</b>			<b>G1020363</b>		21674 19,0 +/W/S	<b>LUC</b>	
2.0 16V	100	ORGA 09184	<b>09.00</b>							
2.0 16V	120	ORGA 09184	<b>02.98</b>							
2.0 HDi 110	80	ORGA 09184	<b>05.01</b>							
2.0	97	ORGA 09185				<b>G1020735</b>		23600 19,4 /Acc/S	<b>BOS</b>	
2.0 16V	100	ORGA 09185								
2.0 16V	120	ORGA 09185								
2.0 HDi 110	80	ORGA 09185								
	1.4 i	55		<b>02.98</b>	<b>08.00</b>	- ABS	<b>G2113185</b>		248 13,0 11,0 +S +C	
	1.4 i	55		<b>02.98</b>	<b>08.00</b>	+ ABS				
	1.6 i	65		<b>02.98</b>	<b>08.00</b>					
	1.8 i	66		<b>02.98</b>	<b>08.00</b>					
	1.8 i	74		<b>04.97</b>	<b>08.00</b>	- (BR)				
	1.9 D	50		<b>02.98</b>	<b>08.00</b>					
	1.9 D	51		<b>02.98</b>	<b>08.00</b>					
	1.9 TD	66		<b>02.98</b>	<b>08.00</b>					
	1.8 16V	81		<b>02.98</b>	<b>08.00</b>		<b>G2120133</b>		266 20,5 18,5 V +S +C	
	1.8 i	74		<b>04.97</b>	<b>08.00</b>	+ (BR)				
	2.0 HDi 90	66		<b>02.99</b>	<b>08.00</b>					
	1.4 HDi 70	50		<b>01.03</b>	<b>03.05</b>		<b>G2122194</b>		266 22,0 20,0 V +S +C	
	1.4 i	55		<b>09.00</b>	<b>03.05</b>					
1.6 16V	80		<b>09.00</b>	<b>03.05</b>						
1.9 D	51		<b>09.00</b>	<b>03.05</b>						
1.9 D	51		<b>09.00</b>	<b>03.05</b>						





CITROEN XSARA (N0) Coupe (97-05)										
	2.0 HDi 90	66		09.00	03.05		G2122194		266 22,0 20,0 V +S +C	
	2.0	97 ORGA 09185			08.00		G2126120		283 26,0 24,0 V +S +C	
	2.0 16V	100 ORGA 09185			03.05					
	2.0 HDi 110	120 ORGA 09185			03.05					
	1.6 16V	80		09.00	03.05		G1020522		20974 10,7	BDX
	1.8 16V	81		02.98	08.00					
	1.8 i	74		04.97	08.00 + (BR)					
	2.0	97		08.98	08.00					
	2.0 16V	100		09.00	03.05					
	2.0 16V	120		02.98	03.05					
	2.0 HDi 110	80		05.01	03.05					
	2.0 HDi 90	66		02.99	03.05					
	1.6 16V	80		09.00	03.05		G2108106		247 8,0 6,0 +S +C	
	1.8 16V	81		02.98	08.00					
	1.8 i	74		04.97	08.00 + (BR)					
	2.0	97		08.98	08.00					
	2.0 16V	100		09.00	03.05					
	2.0 16V	120		02.98	03.05					
	2.0 HDi 110	80		05.01	03.05					
	2.0 HDi 90	66		02.99	03.05					

CITROEN XSARA Picasso (N68) (00-10)											
	1.6	65		06.00	03.10		G1020570		23346 19,0 /WD/S	LUC	
	1.6	67		06.02	03.10						
	1.6	70		09.00	03.10						
	1.6 16V	80		09.05	03.10						
	1.6 HDi 110	80		05.04	03.10						
	1.6 HDi 90	66		09.05	03.10						
	1.8 16V	85		02.00	03.10						
	2.0 16V	100		01.03	03.10						
	2.0 HDi	100		06.00	03.10						
		1.6	65		06.00	03.10 + ESP		G1020614		23708 19,0 /S	BOS
1.6		67		06.02	03.10 + ESP						
1.6		70		09.00	03.10 + ESP						
1.6 16V		80		09.05	03.10 + ESP						
1.6 HDi 110		80		05.04	03.10 + ESP						
1.6 HDi 90		66		09.05	03.10 + ESP						
1.8 16V		85		02.00	03.10 + ESP						
2.0 16V		100		01.03	03.10 + ESP/ + manual transm. <sup>1)</sup>						
2.0 16V		100		01.03	03.10 + autom.transmission <sup>2)</sup>						
2.0 HDi		100		06.00	03.10 + ESP						
	1.6	65		06.00	03.10		G2120133	only for Lucas calipers <sup>3)</sup>	266 20,5 18,5 V +S +C		
	1.6	67		06.02	03.10						
	1.6	70		09.00	03.10						
	1.6 16V	80		09.05	03.10						
	1.6 HDi 110	80		05.04	03.10						
	1.6 HDi 90	66		09.05	03.10						
	1.8 16V	85		02.00	03.10						
	2.0 HDi	100		06.00	03.10						
		1.6	65		06.00	03.10 - ESP		G2122194		266 22,0 20,0 V +S +C	
		1.6	67		06.02	03.10 - ESP					
1.6		70		09.00	03.10 - ESP						
1.6 16V		80		09.05	03.10 - ESP						
1.6 HDi 110		80		05.04	03.10 - ESP						
1.6 HDi 90		66		09.05	03.10 - ESP						
1.8 16V		85		02.00	03.10 - ESP						
2.0 16V		100		01.03	03.10 - ESP/ + manual transm. <sup>4)</sup>						
2.0 HDi		100		06.00	03.10 - ESP						
		1.6 16V	80		09.05	03.10		G1020492		23554 17,1 /WD/S	LUC
	1.6 HDi 110	80		05.04	03.10						
	1.6 HDi 90	66		09.05	03.10						
	1.8 16V	85 ORGA 09492			03.10 + ESP						
	2.0 16V	100 ORGA 09821			03.10						
	2.0 HDi	ORGA 09492			03.10 + ESP						
	1.6 16V	80		09.05	03.10		G2109137		247 9,0 8,0 +S +C		
	1.6 HDi 110	80		05.04	03.10						
	1.6 HDi 90	66		09.05	03.10						
	1.8 16V	85 ORGA 09492			03.10 + ESP						
	2.0 16V	100 ORGA 09821			03.10						
	2.0 HDi	ORGA 09492			03.10 + ESP						

1) + ESP/+ scatola cambio velocità / + ESP/ + transmission mécanique / + ESP/ + cambio de velocidad / + ESP/ + Schaltgetriebe  
2) + scatola cambio automatico / + transmission automatique / + cambio automático / + Automatikgetriebe  
3) solo per pinze Lucas / seulement pour étriers Lucas / solo para pinzas Lucas / nur für Lucas-Sättel  
4) - ESP/+ scatola cambio velocità / - ESP/ + transmission mécanique / - ESP/ + cambio de velocidad / - ESP/ + Schaltgetriebe





**CITROEN ZX (N2) Saloon (91-97)**





















	1.1	40		03.91	08.93	G1020295		20905 18,0 +/WI	BDX
	1.1	44		03.91	06.97				
	1.4	55		03.91	06.97				
	1.4 i	55		03.91	06.97				
	1.6 i	65		03.91	06.97				
	1.9 TD	66		07.92	06.97				
	1.8 D	44		06.93	06.97				
	1.9 D	47		03.91	06.97				
	1.9 D	50		06.94	06.97				
	1.8 D	44	ORGA 06049	06.93					
1.9 D	47	ORGA 06049	03.91						
2.0	122		09.96	10.97	G1020363		21674 19,0 +/WI/S	LUC	
2.0 16V	120		05.96	06.97					
	1.1	40		03.91	08.93	G2110187		247 10,0 9,0 +S +C	
	1.1	44		03.91	06.97				
	1.4	55		03.91	06.97				
	1.4 i	55		03.91	06.97				
	1.9 TD	66		07.92	06.97				
	1.6 i	65		03.91	06.97				
	1.8 16V	81		01.96	06.97				
	1.8 i	74		07.92	06.97				
	1.9 i	88		03.91	06.97				
	1.9 TD	66		07.92	06.97				
	2.0 i	89		07.92	06.97				
	1.8 D	44		06.93	06.97				
	1.9 D	47		03.91	06.97				
	1.9 D	50		06.94	06.97				
2.0	122		09.96	10.97	G2120133		266 20,5 18,5 V +S +C		
2.0 16V	112		07.92	10.94					
	1.6 i	65		03.91	06.97	G1020522		20974 10,7	BDX
	1.8 16V	81		01.96	06.97				
	1.8 D	44		06.93	06.97				
	1.8 i	74		07.92	06.97				
	1.9 D	47		03.91	06.97				
	1.9 D	50		06.94	06.97				
	1.9 i	88		03.91	06.97				
	1.9 TD	66		07.92	06.97				
	2.0	122		09.96	10.97				
	2.0 16V	110		06.94	06.97				
	2.0 16V	112		07.92	10.94				
	2.0 16V	120		05.96	06.97				
	2.0 i	89		07.92	06.97				
	1.6 i	65		03.91	06.97	G2108106		247 8,0 6,0 +S +C	
	1.8 16V	81		01.96	06.97				
	1.8 D	44		06.93	06.97				
	1.8 i	74		07.92	06.97				
	1.9 D	47		03.91	06.97				
	1.9 D	50		06.94	06.97				
	1.9 i	88		03.91	06.97				
	1.9 TD	66		07.92	06.97				
	2.0	122		09.96	10.97				
	2.0 16V	110		06.94	06.97				
	2.0 16V	112		07.92	10.94				
	2.0 16V	120		05.96	06.97				
	2.0 i	89		07.92	06.97				

**CITROEN ZX (N2) Estate (93-98)**













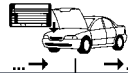











	1.4 i	55		10.93	10.97	G1020295		20905 18,0 +/WI	BDX
	1.6 i	65		10.93	10.97				
	1.4 i	55		10.93	10.97	G2110187		247 10,0 9,0 +S +C	
	1.6 i	65		10.93	10.97				
	1.8 16V	81		01.96	02.98				
	1.8 D	44		10.93	10.97				
	1.8 i	74		10.93	10.97				
	1.9 D	47		10.93	10.97				
	1.9 TD	66		10.93	10.97				
	1.6 i	65		10.93	10.97	G1020522		20974 10,7	BDX
	1.8 16V	81		01.96	02.98				
	1.8 D	44		10.93	10.97				
	1.8 i	74		10.93	10.97				
	1.9 D	47		10.93	10.97				
	1.9 TD	66		10.93	10.97				
	1.6 i	65		10.93	10.97	G2108106		247 8,0 6,0 +S +C	
	1.8 16V	81		01.96	02.98				
	1.8 D	44		10.93	10.97				
	1.8 i	74		10.93	10.97				
	1.9 D	47		10.93	10.97				
	1.9 D	50		06.94	10.97				
	1.9 TD	66		10.93	10.97				



















							
<b>Classic PKW ALFA ROMEO 164 (87-91)</b>							
	2.0 Turbo 2.5 TD 3.0 i V6 3.0 i V6 Q.V.	135 147		09.87 09.87 09.87 07.90	08.91 08.91 08.91 08.91	G2122145	284 22,0 20,2 V + C
	2.0 T.Spark			09.87	08.91	G2110190	252 10,0 9,0 + C
	2.0 Turbo 2.5 TD 3.0 i V6 3.0 i V6 Q.V.	135 147		09.87 09.87 09.87 07.90	08.91 08.91 08.91 08.91	G2110209	251 10,0 9,0 + C
<b>Classic PKW ALFA ROMEO AR 6 (85-89)</b>							
	10 10 Bus 13 14 14 Turbo	51		04.85 04.85 04.85 03.86 09.86	12.89 12.89 12.89 12.89 12.89	G1020147	20741 19,0 +/W/S LUC
<b>Classic PKW AUDI 50 (74-78)</b>							
	0.8 1.1 1.3			01.76 08.74 08.77	07.78 07.78 07.78	G1020097	20228 15,3 ATE
<b>Classic PKW AUDI 80 (72-78)</b>							
	1.3 1.5 1.6 Saloon 1.6 Saloon	55 63		01.72 05.72 09.75 09.75	01.78 08.75 + manual transmission <sup>1)</sup> 07.76 + manual transmission <sup>1)</sup> 07.76 + manual transmission <sup>1)</sup>	G1020097	20228 15,3 ATE
	1.3 1.6			02.78 09.73	08.78 08.78	G1020097 G1020097	20228 15,3 ATE 20228 15,3 ATE
	1.3 1.5 1.6 Saloon 1.6 Saloon	55 63		01.72 05.72 09.75 09.75	07.76 08.75 + manual transmission <sup>1)</sup> 07.76 + manual transmission <sup>1)</sup> 07.76 + manual transmission <sup>1)</sup>	G2110151	239 10,0 8,0 +S +C
	1.3 1.5 1.6 1.6 1.6 1.6 1.6 1.6 1.6 Avant 1.6 Avant 1.6	55 55 61 63 63 55 63 63 81		08.76 05.72 08.76 09.75 09.73 08.76 09.75 01.75 01.75 09.73	08.78 08.75 + autom.transmission <sup>2)</sup> 08.78 07.76 + autom.transmission <sup>2)</sup> 08.78 08.78 07.76 + autom.transmission <sup>2)</sup> 08.78 + S ABS 08.78 + S ABS 08.78	G2112106 G2112106 G2112106 G2112106 G2112106 G2112106 G2112106 G2112106 G2112106 G2112106 G2120123	239 12,0 10,0 +S +C 239 12,0 10,0 +S +C 239 12,0 10,0 +S +C 239 12,0 10,0 +S +C 239 12,0 10,0 +S +C 239 12,0 10,0 +S +C 239 12,0 10,0 +S +C 239 12,0 10,0 +S +C 239 12,0 10,0 +S +C 239 20,0 18,0 V L +S +C
<b>Classic PKW AUDI 80 (79-81)</b>							
	1.3			09.78	07.81	G1020097	20228 15,3 ATE
	1.3 1.6 1.6 D 1.7 2.2			09.78 09.78 08.80 08.80 10.80	07.81 07.81 07.81 07.81 07.81	G2110151 G2112106	239 10,0 8,0 +S +C 239 12,0 10,0 +S +C
<b>Classic PKW AUDI 80 (82-84)</b>							
	1.3 1.6 1.6 D 1.6 TD 1.7 1.8 1.9 2.0 2.2			08.81 08.81 08.81 02.82 08.81 08.81 08.81 08.83 08.81	07.84 07.84 07.84 07.84 07.83 07.84 07.83 07.84 08.83	G2112106	239 12,0 10,0 +S +C
<b>Classic PKW AUDI 80 (84-87)</b>							
	1.3 1.6 1.6 D 1.6 TD			06.84 06.84 06.84 06.84	03.87 03.87 03.87 03.87	G2112106	239 12,0 10,0 +S +C
	1.8 2.0			06.84 02.86	03.87 03.87	G2120123	239 20,0 18,0 V L +S +C
<b>Classic PKW AUDI 80 (87-91)</b>							
	1.6 1.6 D 1.6 TD 1.8 1.9 D 1.9 E 2.0			09.86 02.87 04.88 09.86 08.89 09.86 08.88	07.91 07.89 07.91 07.91 07.91 07.88 07.91	G1020196	20669 19,0 /S LUC
	1.6 1.6 D 1.6 TD 1.8	55		09.86 02.87 04.88 09.86	07.91 + ABS 07.89 + ABS 07.91 + ABS 07.91 + ABS	G1020246	21144 15,8 /S LUC

<sup>1)</sup> + scatola cambio velocità / + transmission mécanique / + cambio de velocidad / + Schaltgetriebe  
<sup>2)</sup> + scatola cambio automatico / + transmission automatique / + cambio automático / + Automatikgetriebe











							
<b>Classic PKW AUDI 80 (87-91)</b>							
	1.8 1.8 1.9 D 1.9 E 2.0	66 82		09.86 09.86 08.89 09.86 08.88	07.91 07.91 + ABS 07.91 07.88 07.91	G1020246	21144 15,8 /S LUC
	1.6 1.6 D 1.6 TD 1.8 1.8 1.8 1.9 D 1.9 E 2.0	55 66 82		09.86 02.87 04.88 09.86 09.86 09.86 08.89 09.86 08.88	07.91 + ABS 07.89 + ABS 07.91 + ABS 07.91 + ABS 07.91 + ABS 07.88 07.91	G2110178	245 10,0 8,0 +C
<b>Classic PKW AUDI 80 Quattro (78-86)</b>							
	1.8 2.0 2.2			08.84 08.83 08.82	08.86 07.84 08.86	G1020246	21144 15,8 /S LUC
<b>Classic PKW AUDI 80 Quattro (87-91)</b>							
	1.8 1.9 E 2.0			09.86 09.86 08.88	09.91 07.88 09.91	G1020196	20669 19,0 /S LUC
	1.8 1.9 E 2.0			09.86 09.86 08.88	09.91 07.88 09.91	G1020246	21144 15,8 /S LUC
<b>Classic PKW AUDI 90 (85-87)</b>							
	2.2	100		10.84	03.87	G1020246	21144 15,8 /S LUC
	2.2	100		10.84	03.87	G2110178	245 10,0 8,0 +C
<b>Classic PKW AUDI 90 (87-91)</b>							
	1.6 TD 1.8 2.0 2.2 2.3	100		04.88 08.89 04.87 04.87 04.87	07.91 07.91 + ABS 07.91 07.91 07.91	G1020196	20669 19,0 /S LUC
	1.6 TD 1.8 2.0 2.2 2.3			04.88 08.89 04.87 04.87 04.87	07.91 + ABS 07.91 07.91 07.91 07.91	G1020246	21144 15,8 /S LUC
	1.6 TD 1.8 2.0 2.2 2.3			04.88 08.89 04.87 04.87 04.87	07.91 + ABS 07.91 07.91 07.91 07.91	G2110178	245 10,0 8,0 +C
<b>Classic PKW AUDI 90 Quattro (84-87)</b>							
	2.2			08.84	03.87	G1020246	21144 15,8 /S LUC
<b>Classic PKW AUDI 90 Quattro (87-91)</b>							
	2.0 2.2 2.3	100		01.88 04.87 04.87	09.91 09.91 09.91	G1020196	20669 19,0 /S LUC
	2.0 2.2 2.3			01.88 04.87 04.87	09.91 09.91 09.91	G1020246	21144 15,8 /S LUC
<b>Classic PKW AUDI 100 Quattro (85-90)</b>							
	1.8 2.2 2.3		44-G-073362 44-G-073362	10.84 08.85 08.86	12.87	G1020197	20901 19,0 +/W/S LUC
	1.8 2.2 2.3			01.88 01.88 01.88	11.90 11.90 11.90	G1020197	20901 19,0 +/W/S LUC
	1.8 2.2 2.2 Turbo 2.3			10.84 10.84 03.86 08.86	11.90 11.90 11.90 11.90	G1020246	21144 15,8 /S LUC
<b>Classic PKW AUDI 100 (80-81)</b>							
	2.2	100		08.79	07.81	G1020196	20669 19,0 /S LUC

Classic PKW AUDI 100 (82)														
	1.9 2.0 D 2.0 TD 2.2			08.81 08.81 11.81 08.81	07.82 07.82 07.82 07.82	+ ventilated discs <sup>1)</sup> + ventilated discs <sup>1)</sup>		G1020196				20669 19,0 /S	LUC	
Classic PKW AUDI 100 (83-90)														
	1.8 1.9 2.0 2.0 D 2.0 TD 2.2 2.2 2.2 GS 2.3 2.4 D			08.82 08.82 08.84 08.82 08.82 08.82 08.82 08.82 10.83 08.89	12.90 07.84 12.90 07.89 12.90 09.86 12.90 12.90 12.90 12.90			G1020197				20901 19,0 +/W/S	LUC	
		85 100 100												
			44-G-073363			for 4 bore wheel rim <sup>2)</sup>								
	1.8 1.9 2.0 2.0 D 2.0 TD 2.2 2.2 2.2 Turbo 2.3 2.4 D 2.5 TDI			08.82 08.82 08.84 08.82 08.82 08.82 08.82 08.86 10.83 08.89 01.90	12.90 07.84 12.90 07.89 12.90 09.86 12.90 12.90 12.90 12.90 12.90	+ ABS + ABS + ABS + ABS + ABS + ABS + ABS		G1020246				21144 15,8 /S	LUC	
		85 100												
	1.8 1.9 2.0 2.0 D 2.0 TD 2.2 2.2 2.3			08.82 08.82 08.84 08.82 08.82 08.82 08.82 10.83	12.87 07.84 12.87 12.87 12.87 09.86 12.87 12.87	+ ABS + ABS + ABS + ABS + ABS		G2110178				245 10,0 8,0 +C		
		85 100												
Classic PKW AUDI 200 Quattro (85-91)														
	2.2		44-G-073362	11.84				G1020197				20901 19,0 +/W/S	LUC	
	2.2			11.84	11.90			G1020246				21144 15,8 /S	LUC	
Classic PKW AUDI 200 (80-83)														
	2.2			10.79	08.83			G1020196				20669 19,0 /S	LUC	
	2.2			10.79	08.83			G1020246				21144 15,8 /S	LUC	
Classic PKW AUDI 200 (84-91)														
	2.1 2.2		44-G-073362 44-G-073362	08.83 08.84				G1020197				20901 19,0 +/W/S	LUC	
	2.1 2.2			08.83 08.84	01.88 12.90			G1020246				21144 15,8 /S	LUC	
Classic PKW AUDI COUPE (81-88)														
	1.6 1.8 1.9 2.0 2.2 2.2		85-E-220000 85-E-220000	02.81 08.81 10.80 09.83 02.81 02.81	08.81 08.83 08.83			G2112106				239 12,0 10,0 +S +C		
		77 85				+ <sup>Ⓢ</sup>								
			85-F-000001		07.88			G2120123				239 20,0 18,0 V L +S +C		
	2.2 2.3	100		09.84 02.87	07.88 07.88			G1020246				21144 15,8 /S	LUC	
	2.2 2.3	100		09.84 02.87	07.88 07.88			G2110178				245 10,0 8,0 +C		
Classic PKW AUDI COUPE Quattro (85-87)														
	2.2 2.3			12.84 01.87	12.87 12.87			G1020246				21144 15,8 /S	LUC	

<sup>1)</sup> + dischi ventilati / + disques ventilés / + disco ventilado / + belüftete Scheiben

<sup>2)</sup> per cerchione a 4 fori / pour jante à 4 trous / para Llantas de 4 taladros / für 4-Loch-Felge

									
<b>Classic PKW AUDI QUATTRO (80-91)</b>									
	2.2		85-C-902000	07.80			G1020196	20669 19,0 /S	LUC
	2.2	119	85-D-900001				G1020197	20901 19,0 +/W/S	LUC
	2.2	147	85-D-900001	85-G-902400					
	2.2	119		08.84	07.89		G1020246	21144 15,8 /S	LUC
	2.2	147		07.80	07.91				
	2.2	162		07.80	07.91				
<b>Classic PKW AUDI V8 (88-94)</b>									
	3.6			10.88	02.94		G1020246	21144 15,8 /S	LUC
	4.2			10.91	02.94				
<b>Classic PKW AUTOBIANCHI Y 10 (85-95)</b>									
	1.0			06.85	12.89		G1020141	20775 18,0 /W/I	BDX
	1.0 i.e.			12.87	12.89				
	1.1 i.e.			01.90	12.95				
	1.1 Turbo			06.85	12.89		G1020140	20839 17,0 /W/S	LUC
	1.3 GT i.e.			02.89	12.95				
<b>Classic PKW BMW 3 series/E30 (82-93)</b>									
	M3			07.86	12.91		G1020308	20995 17,1 +/W/D	ATE
	M3 Convertible			06.88	09.92				
<b>Classic PKW BMW Z1 (88-91)</b>									
	2.5	125		07.88	08.90		G1020308	20995 17,1 +/W/D	ATE
	2.5	125		09.90	06.91		G1020316	20180 17,1 +/W/D	ATE
<b>Classic PKW CITROEN BX (82-93)</b>									
	19 GTi 16V	108		09.88	12.93		G2120133	266 20,5 18,5 V +S +C	
	19 GTi 16V	116		09.87	08.88				
<b>Classic PKW CITROEN C15 (84-05)</b>									
	1.0		ORGA 04196		12.97		G1020299	21614 17,7 +/W/I	LUC
	1.1 (1118)	44		09.87	12.96 + F				
	1.1 (1124)		ORGA 04196		12.96				
	1.3			09.87	05.88 + F				
	1.4	49		07.96	12.96				
	1.4	55		05.87	07.96				
	1.8 D			10.84	12.00				
	1.8 D	44		04.87	08.00				
	1.9 D			12.00	12.05		G1020295	20905 18,0 +/W/I	BDX
	1.0		ORGA 04196		12.97		G2110187	247 10,0 9,0 +S +C	
	1.1 (1118)	44		09.87	12.96 + F				
	1.1 (1124)		ORGA 04196		12.96				
	1.3			09.87	05.88 + F				
	1.4	49	ORGA 04196		12.96				
	1.4	55	ORGA 04196		07.96				
	1.8 D			10.84	12.00				
	1.8 D	44		04.87	08.00				
	1.9 D			12.00	12.05				
<b>Classic PKW CITROEN C25 (81-94)</b>									
	1.8			07.87	03.94		G1020147	20741 19,0 +/W/S	LUC
	1.9 D			07.87	03.94				
	1.9 DT	60		10.91	01.94				
	1.9 TD			04.92	03.94				
	2.0			11.81	03.94				
	2.5 D			10.85	03.94	-1,8 t			
	2.5 D 4X4	55		11.83	12.86	-1,8 t			
	2.5 TD			08.87	03.94	-1,8 t			
<b>Classic PKW CITROEN VISA (78-89)</b>									
	1.7 D			04.84	12.89		G1020299	21614 17,7 +/W/I	LUC
	1.7 D			04.84	12.89		G2110187	247 10,0 9,0 +S +C	
<b>Classic PKW FIAT 131 (74-84)</b>									
	all types			09.82	06.84		G1020141	20775 18,0 /W/I	BDX
<b>Classic PKW FIAT ARGENTA (81-86)</b>									
	1.6 (100)			06.83	08.83		G1020140	20839 17,0 /W/S	LUC
	2.0 (110)			06.83	07.86				
	2.0 i.e. (120)			06.83	07.86				
	2.5 D			06.83	11.85				
	2.5 TD			06.83	07.86				

							
<b>Classic PKW FIAT CROMA (85-90)</b>							
	2.0 i.e. 2.0 i.e.Turbo		12.85 12.85	10.90 10.90	+ armoured vehicles <sup>1)</sup> + armoured vehicles <sup>1)</sup>	G2122145	284 22,0 20,2 V +C
	1.6 1.9 TD 2.0 2.0 i.e. 2.0 i.e.Turbo 2.5 D 2.5 TD		12.85 12.88 12.85 12.85 12.85 12.85 12.85	10.90 10.90 10.90 10.90 10.90 10.90 10.90	- armoured vehicles <sup>2)</sup> - armoured vehicles <sup>2)</sup>	G2110190	252 10,0 9,0 +C
	2.0 i.e. 2.0 i.e.Turbo		12.85 12.85	10.90 10.90	+ armoured vehicles <sup>1)</sup> + armoured vehicles <sup>1)</sup>	G2110209	251 10,0 9,0 +C
<b>Classic PKW FIAT DUCATO (81-93)</b>							
	1.8 1.9 D 2.0 2.4 D 2.4 TD 2.5 D 2.5 TD		09.81 02.87 09.81 05.81 01.86 01.86 07.90	01.94 01.94 01.94 12.85 06.90 01.94 01.94	- Maxi 1,8 t - Maxi 1,8 t	G1020147	20741 19,0 +/W/S LUC
<b>Classic PKW FIAT PANDA (80-85)</b>							
	30 34 45 4x4		09.82 09.82 09.82 09.83	12.85 12.85 12.85 12.85		G1020141	20775 18,0 /W/ BDX
<b>Classic PKW FIAT REGATA (83-89)</b>							
	1.3 1.5 Lim. 1.6 Saloon 1.7 D 1.9 D Saloon 1.9 TD Saloon		09.83 09.83 09.83 09.83 04.84 05.86	09.89 09.89 09.89 03.89 09.89 09.89		G1020141	20775 18,0 /W/ BDX
	1.5 Kombi 1.6 Estate 1.9 D Estate 1.9 TD Estate		09.83 09.83 04.84 05.86	09.89 09.89 09.89 09.89		G1020140	20839 17,0 /W/S LUC
<b>Classic PKW FIAT RITMO (78-88)</b>							
	1.1 1.3 1.5 1.7 D 60		05.85 05.85 05.85 09.82 09.82	09.87 09.87 09.87 09.87 04.85		G1020141	20775 18,0 /W/ BDX
	1.9 TD 105 TC		06.86 05.81	06.88 12.85		G1020140	20839 17,0 /W/S LUC
<b>Classic PKW FIAT TEMPRA (90-93)</b>							
	1.4 i.e. Saloon 1.6 i.e. Saloon		03.90 03.90	04.93 04.93	- ABS/ + manual transmission <sup>3)</sup> - ABS/ + manual transmission <sup>3)</sup>	G1020184	21100 16,7 +/W/S LUC
	1.4 i.e. Estate 1.4 i.e. Saloon 1.4 i.e. Saloon 1.6 i.e. Estate 1.6 i.e. Saloon 1.6 i.e. Saloon 1.8 i.e. 1.9 D 1.9 TD 2.0 i.e.		03.90 03.90 03.90 03.90 03.90 03.90 03.90 03.90 03.90 03.90	04.93 04.93 04.93 04.93 04.93 04.93 04.93 04.93 04.93 04.93	+ autom.transmission <sup>4)</sup> + ABS/ + manual transm. <sup>5)</sup> + autom.transmission <sup>4)</sup> + ABS/ + manual transm. <sup>5)</sup>	G1020140	20839 17,0 /W/S LUC
	1.4 i.e. Estate 1.4 i.e. Saloon 1.4 i.e. Saloon 1.6 i.e. Estate 1.6 i.e. Saloon 1.6 i.e. Saloon 1.8 i.e. Saloon 1.9 D 1.9 TD Saloon		03.90 03.90 03.90 03.90 03.90 03.90 03.90 03.90 03.90	04.93 04.93 04.93 04.93 04.93 04.93 04.93 04.93 04.93	+ autom.transmission <sup>4)</sup> + ABS/ + manual transm. <sup>5)</sup> + autom.transmission <sup>4)</sup> + ABS/ + manual transm. <sup>5)</sup>	G2112127	258 12,0 10,2 +C
	1.8 i.e. Estate 1.9 TD Estate 2.0 i.e.		03.90 03.90 03.90	04.93 04.93 04.93		G2120142	258 20,0 18,2 V L +C
	1.4 i.e. 1.6 i.e. 1.8 i.e. 1.9 D 1.9 TD 2.0 i.e.		03.90 03.90 03.90 03.90 03.90 03.90	04.93 04.93 04.93 04.93 04.93 04.93	+ ABS + ABS + ABS + ABS + ABS	G1020236	21103 14,2 /S LUC

<sup>1)</sup> + veicoli blindati / + véhicules blindés / + vehiculo blindado / + gepanzerte Fahrzeuge

<sup>2)</sup> - veicoli blindati / - véhicules blindés / - vehiculo blindado / - gepanzerte Fahrzeuge

<sup>3)</sup> - ABS/ + scatola camb.velocità / - ABS/ + transmission mécanique / - ABS/ + cambio de velocidad / - ABS/ + Schaltgetriebe

<sup>4)</sup> + scatola cambio automatico / + transmission automatique / + cambio automático / + Automatikgetriebe

<sup>5)</sup> + ABS/ + scatola camb.velocità / + ABS/ + transmission mécanique / + ABS/ + cambio de velocidad / + ABS/ + Schaltgetriebe



### Classic PKW FIAT TIPO (88-93)

	1.1		01.88	04.93	- ABS	G1020184		21100 16,7 +/W/S	LUC				
	1.4		01.88	04.93	- ABS								
	1.4 i.e.		01.88	04.93	- ABS								
	1.6		01.88	04.93	- ABS/ + manual transmission <sup>1)</sup>								
	1.6 i.e.	57	01.88	04.93	- ABS/ + manual transmission <sup>1)</sup>								
	1.7 D		01.88	04.93	- ABS								
	1.9 D		01.88	04.93	- ABS								
	1.1		01.88	04.93	+ ABS					G1020140		20839 17,0 /W/S	LUC
	1.4		01.88	04.93	+ ABS								
	1.4 i.e.		01.88	04.93	+ ABS								
1.6		01.88	04.93	+ autom.transmission <sup>2)</sup>									
1.6		01.88	04.93	+ ABS/ + manual transm. <sup>3)</sup>									
1.6 i.e.	57	01.88	04.93	+ autom.transmission <sup>2)</sup>									
1.6 i.e.	57	01.88	04.93	+ ABS/ + manual transm. <sup>3)</sup>									
1.6 i.e.	66	01.88	12.91										
1.7 D		01.88	04.93	+ ABS									
1.8 i.e.		03.90	04.93										
1.8 i.e. 16V	101	10.89	04.93		G2112127		258 12,0 10,2 +C						
1.9 D		01.88	04.93	+ ABS									
1.9 TD		01.88	04.93										
2.0 i.e.	80	09.90	04.93										
1.1		01.88	04.93	+ ABS					G2120142		258 20,0 18,2 V L +C		
1.4		01.88	04.93	+ ABS									
1.4 i.e.		01.88	04.93	+ ABS									
1.6		01.88	04.93	+ autom.transmission <sup>2)</sup>									
1.6		01.88	04.93	+ ABS/ + manual transm. <sup>3)</sup>									
1.6 i.e.	57	01.88	04.93	+ autom.transmission <sup>2)</sup>									
1.6 i.e.	57	01.88	04.93	+ ABS/ + manual transm. <sup>3)</sup>									
1.6 i.e.	66	01.88	12.91										
1.7 D		01.88	04.93	+ ABS									
1.8 i.e.		03.90	04.93										
1.9 D		01.88	04.93	+ ABS	G1020236		21103 14,2 /S	LUC					
1.9 TD		01.88	04.93										
1.8 i.e. 16V	101	10.89	04.93										
1.9 D		01.88	04.93	+ ABS									
1.9 TD		01.88	04.93	+ ABS									
2.0 i.e.		09.90	04.93										
2.0 i.e. 16V		01.91	04.93										

### Classic PKW FIAT UNO (83-89)

	1.3 D		03.83	09.89		G1020141		20775 18,0 /W/	BDX				
	1.7 D		02.84	09.89									
	45		03.83	09.89									
	55		03.83	09.89									
	60		03.83	09.89									
	70		03.83	09.89									
	75		10.85	09.89									
	1.3 i.e. Turbo		05.85	09.89						G1020140		20839 17,0 /W/S	LUC
	1.7 TD		05.86	09.89	+								
	75		10.85	09.89									

### Classic PKW FIAT UNO (90-95)

	0.9		10.89	06.95		G1020141		20775 18,0 /W/	BDX				
	1.0 i.e.		10.89	06.95									
	1.1 i.e.		10.89	06.95									
	1.4 i.e.		10.89	06.95									
	1.5 i.e.		10.89	06.95									
	1.7 D		10.89	06.95									
	1.3 i.e. Turbo		10.89	03.92						G1020140		20839 17,0 /W/S	LUC
	1.4 i.e. Turbo		10.89	06.95									
	1.4 TD		10.89	06.95									
	1.5 i.e.		10.89	06.95									
1.9 TD		10.89	06.95	+									

### Classic PKW FORD ESCORT / ORION (81-85)

	all types		08.80	12.85	- Turbo	G1020334		20640 17,5 +	ATE
	1.6 RS Turbo		09.84	12.85		G1020026		20907 18,0 +	ATE

















### Classic PKW FORD ESCORT / ORION (86-90)























	all types		01.86	08.90	- Turbo	G1020334		20640 17,5 +	ATE
	1.6 RS Turbo		01.86	08.90		G1020026		20907 18,0 +	ATE

<sup>1)</sup> - ABS/+ scatola camb.velocità / - ABS/ + transmission mécanique / - ABS/ + cambio de velocidad / - ABS/ + Schaltgetriebe

























<sup>2)</sup> + scatola cambio automatico / + transmission automatique / + cambio automático / + Automatikgetriebe

<sup>3)</sup> + ABS/+ scatola camb.velocità / + ABS/ + transmission mécanique / + ABS/ + cambio de velocidad / + ABS/ + Schaltgetriebe

							
<b>Classic PKW FORD FIESTA (76-89)</b>							
	1.6 XR2		09.81	04.89		G1020334	20640 17,5 + ATE
<b>Classic PKW FORD SCORPIO / GRANADA (GB) (85-91)</b>							
	all types		03.85	01.92	- 2,9 i-24V	G1020026	20907 18,0 + ATE
	all types		03.85	01.92		G1020028	20981 13,8 /S LUC
<b>Classic PKW FORD SCORPIO / GRANADA (GB) (92-94)</b>							
	2.0 i 2.4 i V6 2.5 TD 2.9 i V6 2.9 i V6 4x4		02.92 02.92 02.92 02.92 08.92	07.92 07.92 07.92 07.92 09.94		G1020026	20907 18,0 + ATE
	2.0 i 2.4 i V6 2.5 TD 2.9 i V6		08.92 08.92 08.92 08.92	09.94 09.94 09.94 09.94		G1020320	21394 17,5 + ATE
	2.0 i 2.4 i V6 2.5 TD 2.9 i V6		02.92 02.92 02.92 02.92	09.94 09.94 09.94 09.94		G1020028	20981 13,8 /S LUC
<b>Classic PKW FORD SIERRA (82-86)</b>							
	1.6 Estate 1.8 2.0 2.0 i 2.3 2.3 D		05.86 10.84 08.82 02.85 08.82 08.82	12.86 12.86 12.86 12.86 12.86 12.86	- ABS - ABS - ABS - ABS - ABS - ABS	G1020334	20640 17,5 + ATE
	2.8 i Saloon all types		02.85 03.86	12.86 12.86	+ ABS/ - Cosworth-Turbo	G1020026	20907 18,0 + ATE
	2.0 i 2.8 i all types		02.85 02.85 03.86	12.86 12.86 12.86	+ ABS	G1020028	20981 13,8 /S LUC
	2.0 i 2.8 i all types		02.85 02.85 03.86	12.86 12.86 12.86	+ ABS	G2110115	253 10,2 8,9 +C
<b>Classic PKW FORD SIERRA (87-93)</b>							
	1.6 Estate 1.6 Saloon 1.8 Estate 1.8 Saloon 1.8 TD Kombi 1.8 TD Saloon 2.0 Estate 2.0 i Estate 2.0 i Saloon 2.0 Saloon 2.3 D Estate 2.3 D Saloon		01.87 01.87 01.87 01.87 08.88 01.90 01.87 01.87 01.87 01.87 01.87 01.87	02.93 02.93 02.93 02.93 02.93 02.93 02.93 02.93 02.93 02.93 02.93 02.93	- ABS - ABS - ABS - ABS - ABS - ABS - ABS - ABS - ABS - ABS - ABS - ABS	G1020334	20640 17,5 + ATE
	1.6 Estate 1.6 Saloon 1.8 Estate 1.8 Saloon 1.8 TD Kombi 1.8 TD Saloon 2.0 Estate 2.0 i Estate 2.0 i Saloon 2.0 Saloon 2.3 D Estate 2.3 D Saloon 2.8 i Kombi 2.8 i Lim. 2.9 i Kombi 2.9 i Lim.		01.87 01.87 01.87 01.87 08.88 01.90 01.87 01.87 01.87 01.87 01.87 01.87 01.87 01.87 01.87 08.88 08.88 08.88	02.93 02.93 02.93 02.93 02.93 02.93 02.93 02.93 02.93 02.93 02.93 02.93 02.93 02.93 02.93 02.93 02.93 02.93	+ ABS + ABS + ABS + ABS + ABS + ABS + ABS + ABS + ABS + ABS + ABS + ABS + ABS + ABS + ABS + ABS + ABS + ABS	G1020026	20907 18,0 + ATE
	1.6 Estate 1.6 Saloon 1.8 Estate 1.8 Saloon 1.8 TD Kombi 1.8 TD Saloon 2.0 Estate 2.0 i 4x4 Kombi 2.0 i 4x4 Lim. 2.0 i Estate 2.0 i Saloon 2.0 RS Cosworth Turbo 2.0 Saloon 2.8 i 4x4 Kombi		01.87 01.87 01.87 01.87 08.88 01.90 01.87 05.89 01.90 01.87 01.87 01.87 01.87 01.87	02.93 02.93 02.93 02.93 02.93 02.93 02.93 02.93 02.93 02.93 02.93 12.89 02.93 02.93	+ ABS + ABS + ABS + ABS + ABS + ABS + ABS + ABS + ABS - ABS - ABS + ABS + ABS	G1020028	20981 13,8 /S LUC

								
<b>Classic PKW FORD SIERRA (87-93)</b>								
	2.8 i Kombi 2.8 i Lim. 2.9 i 4x4 Kombi 2.9 i 4x4 Lim. 2.9 i Kombi 2.9 i Lim.		01.87 01.87 08.88 08.88 08.88 08.88	02.93 08.88 02.93 02.93 02.93 02.93		G1020028		20981 13,8 /S LUC
	1.6 Estate 1.6 Saloon 1.8 Estate 1.8 Saloon 1.8 TD Kombi 1.8 TD Saloon 2.0 Estate 2.0 i 4x4 Kombi 2.0 i 4x4 Lim. 2.0 i Estate 2.0 i Saloon 2.0 Saloon 2.8 i 4x4 Kombi 2.8 i Kombi 2.8 i Lim. 2.9 i 4x4 Kombi 2.9 i 4x4 Lim. 2.9 i Kombi 2.9 i Lim.		01.87 01.87 01.87 01.87 08.88 01.90 01.87 05.89 01.90 01.87 01.87 01.87 01.87 01.87 01.87 08.88 08.88 08.88 08.88	02.93 + ABS 02.93 + ABS 02.93 + ABS 02.93 + ABS 02.93 + ABS 02.93 - ABS 02.93 - ABS 02.93 + ABS 02.93 02.93 02.93 02.93 02.93		G2110115		253 10,2 8,9 +C
<b>Classic PKW HONDA ACCORD (85-89)</b>								
	2.0 i (CA5) 2.0 i 16V (CA5) 2.0 i Aero Deck (CA5)		09.85 12.86 09.85	12.89 12.89 12.89		G2110212		239 10,0 8,0 +S +C
<b>Classic PKW HONDA CIVIC (3-door) (87-91)</b>								
	1.6 i 16V VTEC (EE9)		06.90	08.91		G2121105		262 21,0 19,0 V +S +C
	1.6 i 16V (ED7) 1.6 i 16V VTEC (EE9)		09.87 06.90	08.91 08.91		G2110212		239 10,0 8,0 +S +C
<b>Classic PKW HONDA CIVIC (4-door) (87-91)</b>								
	1.6 i 16V (ED4) 1.6 i 16V 4x4 (ED4)		09.87 09.87	08.91 08.91		G2110212		239 10,0 8,0 +S +C
<b>Classic PKW HONDA CRX (87-91)</b>								
	1.6 i 16V VTEC (EE8)		06.90	08.91		G2121105		262 21,0 19,0 V +S +C
	1.6 i 16V (ED9) 1.6 i 16V VTEC (EE8)		09.87 06.90	08.91 08.91		G2110212		239 10,0 8,0 +S +C
<b>Classic PKW HONDA PRELUDE (87-91)</b>								
	2.0 (BA4) 2.0 i 16V (BA4) 2.0 i 16V (BA4)	80 101 103	09.87 09.87 09.87	12.91 12.91 12.91		G2110212		239 10,0 8,0 +S +C
<b>Classic PKW LANCIA DEDRA (90-93)</b>								
	1.6 i.e. 1.6 i.e. 1.6 i.e. 1.8 i.e. 1.9 TD 2.0 i.e. 2.0 TD		01.90 02.93 01.90 01.90 01.90 01.90 01.90	01.93 10.93 + ABS 10.93 10.93 10.93 10.93		G1020184 G1020140		21100 16,7 +M/S LUC 20839 17,0 /M/S LUC
	1.6 i.e. 1.6 i.e. 1.8 i.e. 1.9 TD 2.0 TD 2.0 i.e.		02.93 01.90 01.90 01.90 01.90 01.90	10.93 + ABS 10.93 10.93 10.93 10.93		G2112127 G2120142		258 12,0 10,2 +C 258 20,0 18,2 V L +C
	1.6 i.e. 1.8 i.e. 1.9 TD 2.0 i.e. 2.0 i.e. Turbo 2.0 Integrale 2.0 TD	66	01.90 01.90 01.90 01.90 05.91 09.91 01.90	10.93 + ABS 10.93 10.93 10.93 10.93 10.93		G1020236		21103 14,2 /S LUC
<b>Classic PKW LANCIA DELTA (79-86)</b>								
	1.6 GT 1.6 HF Turbo	285797 272995	06.86 06.86			G1020140		20839 17,0 /M/S LUC



							
<b>Classic PKW LANCIA DELTA (86-93)</b>							
	1.6 i.e.			07.86	04.90	G1020140	20839 17,0 /W/S LUC
	2.0 i.e. 16V 2.0 i.e. 16V Turbo			07.86 07.86	12.91 12.91	G2122147	284 22,0 20,2 V +C
	2.0 HF Integrale 2.0 i.e.16V Integrale			11.87 06.89	10.93 10.93	G2110209	251 10,0 9,0 +C
<b>Classic PKW LANCIA PRISMA (83-86)</b>							
	1.6	3067650			06.86	G1020140	20839 17,0 /W/S LUC
<b>Classic PKW LANCIA THEMA (84-88)</b>							
	2.0 i.e. 2.0 i.e. Turbo 2.8 i.e. V6 2.9 i.e. 8.32			10.84 10.84 10.84 09.87	01.89 01.89 01.89 01.89	G2122145	284 22,0 20,2 V +C + armoured vehicles <sup>1)</sup> + armoured vehicles <sup>1)</sup> + armoured vehicles <sup>1)</sup>
	2.0 i.e. 2.0 i.e. Turbo 2.5 TD 2.8 i.e. V6			10.84 10.84 10.84 10.84	01.89 01.89 01.89 01.89	G2110190	252 10,0 9,0 +C - armoured vehicles <sup>2)</sup> - armoured vehicles <sup>2)</sup> - armoured vehicles <sup>2)</sup>
	2.0 i.e. 2.0 i.e. Turbo 2.8 i.e. V6 2.9 i.e. 8.32			10.84 10.84 10.84 09.87	01.89 01.89 01.89 01.89	G2110209	251 10,0 9,0 +C + armoured vehicles <sup>1)</sup> + armoured vehicles <sup>1)</sup> + armoured vehicles <sup>1)</sup>
<b>Classic PKW LANCIA THEMA (89-92)</b>							
	2.0 i.e. 16V Turbo 2.0 i.e. Turbo			10.89 02.89	09.92 09.92	G2122147	284 22,0 20,2 V +C - armoured vehicles <sup>2)</sup> - armoured vehicles <sup>2)</sup>
	2.0 i.e. 2.0 i.e. 16V 2.0 i.e. 16V Turbo 2.0 i.e. Turbo 2.8 i.e. V6 2.9 i.e. 8.32			02.89 10.89 10.89 02.89 02.89 02.89	09.92 09.92 09.92 09.92 09.92 09.92	G2122145	284 22,0 20,2 V +C + armoured vehicles <sup>1)</sup> + armoured vehicles <sup>1)</sup> + armoured vehicles <sup>1)</sup> + armoured vehicles <sup>1)</sup> + armoured vehicles <sup>1)</sup>
	2.0 i.e. 2.0 i.e. 16V 2.0 i.e. 16V Turbo 2.0 i.e. Turbo 2.5 TD 2.8 i.e. V6			02.89 10.89 10.89 02.89 02.89 02.89	09.92 09.92 09.92 09.92 09.92 09.92	G2110190	252 10,0 9,0 +C - armoured vehicles <sup>2)</sup> - armoured vehicles <sup>2)</sup> - armoured vehicles <sup>2)</sup> - armoured vehicles <sup>2)</sup>
	2.0 i.e. 2.0 i.e. 16V 2.0 i.e. 16V Turbo 2.0 i.e. Turbo 2.8 i.e. V6 2.9 i.e. 8.32			02.89 10.89 10.89 02.89 02.89 02.89	09.92 09.92 09.92 09.92 09.92 09.92	G2110209	251 10,0 9,0 +C + armoured vehicles <sup>1)</sup> + armoured vehicles <sup>1)</sup> + armoured vehicles <sup>1)</sup> + armoured vehicles <sup>1)</sup> + armoured vehicles <sup>1)</sup>
<b>Classic PKW MERCEDES BENZ (R129) SL-Class (89-93)</b>							
	300 SL 300 SL 24 500 SL			06.89 06.89 06.89	07.93 07.93 07.93	G1020339	21197 15,0 /WD ATE
	600 SL V12			06.92	07.93	G1020400	21305 16,1 /WD ATE
<b>Classic PKW MERCEDES BENZ (W124) E-Class (85-93)</b>							
	200 200 CE 200 D 200 E 220 CE 220 E 230 CE 230 E 250 D 250 D Turbo 260 E 260 E 4-Matic 280 E 300 CE 300 D 300 D 4-Matic 300 D Turbo 300 E 300 E 4-Matic			01.85 04.90 01.85 01.85 10.92 10.92 05.87 01.85 01.85 09.88 01.85 05.85 10.92 05.87 01.85 12.86 09.87 01.85 11.86	02.90 06.93 06.93 06.93 06.93 06.93 09.92 09.92 06.93 06.93 09.92 08.91 06.93 09.92 06.93 08.91 06.93 06.93 09.92 06.93	G1020044	20941 19,3 /WD/S LUC + wheel base 2800 mm <sup>3)</sup>
	200 T 200 TD 200 TE 220 TE 230 E Estate 230 TE 250 D Estate 250 TD 250 TD Turbo			10.85 10.85 10.88 10.92 01.85 10.85 10.85 10.85 04.90	02.90 08.91 06.93 06.93 09.92 09.92 06.93 06.93 06.93	G1020044	20941 19,3 /WD/S LUC + special body <sup>4)</sup> + special body <sup>4)</sup> + 

<sup>1)</sup> + veicoli blindati / + véhicule blindé / + vehículo blindado / + gepanzerte Fahrzeuge

<sup>2)</sup> - veicoli blindati / - véhicule blindé / - vehículo blindado / - gepanzerte Fahrzeuge

<sup>3)</sup> + passo 2800 mm / + empattement 2800 mm / + distancia entre ejes 2800 mm / + Radstand 2800mm

<sup>4)</sup> + carrozzeria speciale / + carrosserie spéciale / + construcc.carroceria especial / + Spezialaufbau



**Classic PKW MERCEDES BENZ (W124) E-Class (85-93)**

	260 E Estate 280 TE 300 TD 300 TD Turbo 300 TD Turbo 4-Matic 300 TE 300 TE 4-Matic			10.85 09.92 + special body <sup>1)</sup> 10.92 06.93 04.86 06.93 10.85 06.93 03.87 06.93 10.85 09.92 11.86 06.93	G1020044		20941 19,3 /WD/S	LUC
	200 200 CE 200 D 200 E 220 CE 220 E 230 CE 230 E 250 D 250 D Turbo 260 E 260 E 4-Matic 280 E 300 CE 300 D 300 D 4-Matic 300 D Turbo 300 E 300 E 4-Matic			01.85 02.90 04.90 06.93 01.85 06.93 01.85 06.93 10.92 06.93 10.92 06.93 05.87 09.92 01.85 09.92 01.85 06.93 + wheel base 2800 mm <sup>2)</sup> 09.88 06.93 01.85 09.92 - ASR/ + wheel base 2800mm <sup>3)</sup> 05.85 08.91 10.92 06.93 - ASR/ + wheel base 2800mm <sup>3)</sup> 05.87 09.92 - ASR 01.85 06.93 12.86 08.91 09.87 06.93 01.85 09.92 - ASR 11.86 06.93	G1020046		20687 15,5	ATE
	200 T 200 TD 200 TE 220 TE 230 E Estate 230 TE 250 D 250 D Estate 250 TD 250 TD Turbo 260 E 260 E Estate 280 TE 300 CE-24 Convert. 300 CE-24 Coupe 300 E 24 300 TD 300 TD Turbo 300 TD Turbo 4-Matic 300 TE 300 TE 4-Matic 320 CE 320 E			10.85 02.90 10.85 08.91 10.88 06.93 10.92 06.93 01.85 09.92 + special body <sup>1)</sup> 10.85 09.92 01.90 06.93 + wheel base 3600 mm <sup>4)</sup> 10.85 06.93 + special body <sup>1)</sup> 10.85 06.93 04.90 06.93 + ⊕ 01.90 09.92 + wheel base 3600 mm <sup>4)</sup> 10.85 09.92 + special body <sup>1)</sup> 10.92 06.93 01.92 06.93 09.89 09.92 09.89 09.92 04.86 06.93 10.85 06.93 03.87 06.93 10.85 09.92 11.86 06.93 10.92 06.93 10.92 06.93	G1020339		21197 15,0 /WD	ATE
	280 E 280 E Estate 300 TE 24 320 TE			10.92 06.93 + wheel base 3600 mm <sup>4)</sup> 10.92 06.93 + special body <sup>1)</sup> 09.89 09.92 10.92 06.93	G1020339		21197 15,0 /WD	ATE
	400 E 500 E			10.92 06.93 01.91	G1020339		21197 15,0 /WD	ATE
	500 E	B927761	B927760	06.93	G1020400		21305 16,1 /WD	ATE
	200 200 CE 200 D 200 E 220 CE 220 E 230 CE 230 E 250 D 250 D Turbo 260 E 260 E 4-Matic 280 E 300 CE 300 D 300 D 4-Matic 300 D Turbo 300 E 300 E 4-Matic			01.85 02.90 04.90 06.93 01.85 06.93 01.85 06.93 10.92 06.93 10.92 06.93 05.87 09.92 01.85 09.92 01.85 06.93 + wheel base 2800 mm <sup>2)</sup> 09.88 06.93 01.85 09.92 + wheel base 2800 mm <sup>2)</sup> 05.85 08.91 10.92 06.93 + wheel base 2800 mm <sup>2)</sup> 05.87 09.92 01.85 06.93 12.86 08.91 09.87 06.93 01.85 09.92 11.86 06.93	G2109120		258 9,0 7,3 +S +C	
	200 T 200 TD 200 TE 220 TE 230 E Estate 230 TE 250 D 250 D Estate 250 TD 250 TD Turbo 260 E			10.85 02.90 10.85 08.91 10.88 06.93 10.92 06.93 01.85 06.93 + special body <sup>1)</sup> 10.85 09.92 01.90 06.93 + wheel base 3600 mm <sup>4)</sup> 10.85 06.93 + special body <sup>1)</sup> 10.85 06.93 04.90 06.93 + ⊕ 01.90 09.92 + wheel base 3600 mm <sup>4)</sup>	G2109114		278 9,0 7,3 +S +C	

<sup>1)</sup> + carrozzeria speciale / + carrosserie spéciale / + construcc.carroceria especial / + Spezialaufbau  
<sup>2)</sup> + passo 2800 mm / + empattement 2800 mm / + distancia entre ejes 2800 mm / + Radstand 2800mm  
<sup>3)</sup> - ASR/+ passo 2800mm / - ASR/+ empattement 2800mm / - ASR/+ dist.entre ejes 2800mm / - ASR/+ Radstand 2800mm  
<sup>4)</sup> + passo 3600 mm / + empattement 3600 mm / + distancia entre ejes 3600 mm / + Radstand 3600mm



<b>Classic PKW MERCEDES BENZ (W124) E-Class (85-93)</b>								
	260 E Estate 280 TE 300 CE-24 Convert. 300 CE-24 Coupe 300 E 24 300 TD 300 TD Turbo 300 TD Turbo 4-Matic 300 TE 300 TE 4-Matic 320 CE 320 E			10.85 10.92 01.92 09.89 09.89 04.86 10.85 03.87 10.85 11.86 10.92 10.92	06.93 06.93 06.93 09.92 09.92 06.93 06.93 09.92 06.93 06.93 06.93 06.93	+ special body <sup>1)</sup>	G2109114	278 9,0 7,3 +S +C
<b>Classic PKW MERCEDES BENZ (W201) 190-190 E 2,6 (82-93)</b>								
	190 190 D 190 D 2.2 190 D 2.5 190 D 2.5 Turbo 190 E 1.8 190 E 2.0 190 E 2.3 190 E 2.6 190 E 2.3 16V 190 E 2.5 16V			04.82 09.83 09.83 05.85 11.87 03.90 04.82 09.83 04.86 07.84 09.88	02.90 05.93 09.85 05.93 05.93 05.93 05.93 05.93 05.93 08.88 05.93		G1020257	21055 17,0 /WD/S LUC
	190 190 D 190 D 2.2 190 D 2.5 190 D 2.5 Turbo 190 E 1.8 190 E 2.0 190 E 2.3 190 E 2.6 190 E 2.3 16V 190 E 2.5 16V 190 E 2.5 16V Evolut.		173	04.82 09.83 09.83 05.85 11.87 03.90 04.82 09.83 04.86 07.84 09.88 03.89	02.90 05.93 09.85 05.93 05.93 05.93 05.93 05.93 05.93 08.88 05.93 05.93	+ USA	G1020022 G1020046 G1020339	- ASR 20687 13,5 ATE 21197 15,0 /WD ATE
	190 190 D 190 D 2.2 190 D 2.5 190 D 2.5 Turbo 190 E 1.8 190 E 2.0 190 E 2.3 190 E 2.3 16V 190 E 2.5 16V 190 E 2.6			04.82 09.83 09.83 05.85 11.87 03.90 04.82 09.83 07.84 09.88 04.86	02.90 05.93 09.85 05.93 05.93 05.93 05.93 05.93 08.88 05.93 05.93	+ USA	G2109120	258 9,0 7,3 +S +C
<b>Classic PKW MERCEDES BENZ G-Class (W461) (90-)</b>								
	G 320 CDI	135		02.09			G1020583	23021 18,9 /WD BOS
<b>Classic PKW OPEL ASCONA B / Vauxhall Cavalier (75-81)</b>								
	1.3 1.6 2.0 2.0 D			03.79 03.79 03.79 03.79	07.81 07.81 07.81 07.81	+ fist type calipers <sup>2)</sup> + fist type calipers <sup>2)</sup> + fist type calipers <sup>2)</sup> + fist type calipers <sup>2)</sup>	G1020015	20939 15,8 /WD DEL
<b>Classic PKW OPEL ASCONA C / Vauxhall Cavalier (82-88)</b>								
	1.3 1.6 1.6 D 1.8 1.8 i 2.0 i N 2.0 i S			08.81 08.81 01.82 09.82 09.82 10.87 10.87	08.88 08.88 08.88 08.88 08.88 08.88 08.88	- ventilated discs <sup>3)</sup> + ventilated discs <sup>4)</sup>	G1020015 G1020015 G1020258 G1020015	20939 15,8 /WD DEL 20939 15,8 /WD DEL 21190 17,5 +/WD ATE 20939 15,8 /WD DEL
	1.3 1.6 1.6 D 1.8 1.8 i 2.0 i N 2.0 i S			08.81 08.81 01.82 09.82 09.82 08.81 10.87	08.88 08.88 08.88 08.88 08.88 08.88 08.88	- ventilated discs <sup>3)</sup> + ventilated discs <sup>4)</sup>	G2113161 G2120115 G2124115	236 12,7 9,7 +S +C 236 20,0 17,0 V L +S +C 256 24,0 21,0 V L +S +C
<b>Classic PKW OPEL CORSA A / Vauxhall Nova (83-92)</b>								
	1.0 S 1.2 1.3 1.4 N 1.5 D 1.5 TD 1.6 i N 1.6 i SE			M4999999 M4999999 M4999999 M4999999 M4999999 M4999999 M4999999 M4999999	09.82 09.82 09.82 08.89 09.87 03.88 03.88 01.88		G1020015 G1020015 G1020015	20939 15,8 /WD DEL 20939 15,8 /WD DEL 20939 15,8 /WD DEL

<sup>1)</sup> + carrozzeria speciale / + carrosserie spéciale / + construcc.carroceria especial / + Spezialaufbau

<sup>2)</sup> + pinza freno flottante / + étriers à griffe / + pinza de puno / + Faustsättel

<sup>3)</sup> - dischi ventilati / - disques ventilés / - disco ventilado / - belüftete Scheiben

<sup>4)</sup> + dischi ventilati / + disques ventilés / + disco ventilado / + belüftete Scheiben



### Classic PKW OPEL CORSA A / Vauxhall Nova (83-92)

	1.0 S	N4000001		10.92		G1020317		20547 16,5 +WD	ATE
	1.2	N4000001		10.92					
	1.4 i SE	N4000001		10.92					
	1.4 N	N4000001		10.92					
	1.5 D	N4000001		10.92					
	1.5 TD	N4000001		10.92					
	1.6 i N	N4000001		10.92					
1.6 i SE	N4000001		10.92						
	1.0 S	N4000001		10.92		G2113161		236 12,7 9,7 +S +C	
	1.2	N4000001		10.92					
	1.4 N	N4000001		10.92					
	1.5 D			09.87	10.92				
	1.5 TD			03.88	10.92				
	1.6 i N		M4999999	03.88	10.92				
1.4 i SE	N4000001		10.92		G2120115		236 20,0 17,0 V L +S +C		
1.6 i N	N4000001		10.92						
1.6 i SE			01.88	10.92					

### Classic PKW OPEL KADETT D / Vauxhall Astra D (79-84)

	1.0			08.79	07.84	G1020015		20939 15,8 /WD	DEL
	1.2			08.79	07.84				
	1.3			08.79	07.84				
	1.6			01.82	07.84				
	1.6 D			01.82	07.84				
	1.8			01.82	07.84				
	1.3			08.79	07.84	+ autom.transmission <sup>1)</sup>	G2113161	236 12,7 9,7 +S +C	
	1.3			08.79	07.84	+ heavy duty br./+manual transm. <sup>2)</sup>			
	1.6			01.82	07.84				
	1.6 D			01.82	07.84				
	1.8 i			01.82	07.84		G2120115	236 20,0 17,0 V L +S +C	

### Classic PKW OPEL KADETT E / Vau. Astra E/Belmont (84-93)

	1.2			08.84	09.91	G1020015		20939 15,8 /WD	DEL
	1.3			08.84	09.91				
	1.4			08.89	09.91				
	1.5 TD			07.88	09.91				
	1.6			08.84	09.91				
	1.6 D			08.84	09.91				
	1.7 D			08.88	09.91				
1.8 Caravan			K5025260	08.84		G1020015		20939 15,8 /WD	DEL
	1.8 Caravan		K2500077	08.84					
	1.8 Saloon		L5000000	08.84					
	1.8 Saloon Combo		L2500000	08.84					
1.8 Caravan					09.91				
	1.8 Caravan	K5025261			09.91	G1020258		21190 17,5 +WD	ATE
	1.8 Caravan	K2500078			09.91	G1020015		20939 15,8 /WD	DEL
	1.8 Saloon	L5000001			09.91				
	1.8 Saloon	L2500001			09.91				
	2.0 i			08.85	09.91				
	2.0 i 16V			08.87	09.91				
	1.2			08.84	09.91	G2113161		236 12,7 9,7 +S +C	
	1.3			08.84	09.91				
	1.4			08.89	09.91				
1.5 TD				07.88	09.91				
	1.6			08.84	09.91				
	1.6 D			08.84	09.91				
	1.7 D			08.88	09.91				
	1.8			08.84	09.91				
1.6 D				08.84	09.91	G2120115		236 20,0 17,0 V L +S +C	
	1.6 D			08.84	09.91				
	1.7 D			08.88	09.91				
	1.8 i			08.84	09.91				
1.8 i				08.84	09.91	G2124115		256 24,0 21,0 V L +S +C	
	2.0 i			08.85	09.91				
	2.0 i 16V			08.87	09.91				
	2.0 i 16V Saloon			08.87	09.91	G1020272		21140 15,0	ATE

### Classic PKW OPEL MANTA B / Vauxhall Cavalier Coupe (76-88)

	1.2			09.78	12.88	+ fist type calipers <sup>3)</sup>	G1020015	20939 15,8 /WD	DEL
	1.3			01.80	12.86	+ fist type calipers <sup>3)</sup>			
	1.6			09.78	12.82	+ fist type calipers <sup>3)</sup>			
	1.8			01.82	12.88	+ fist type calipers <sup>3)</sup>			
	2.0			09.78	12.88	+ fist type calipers <sup>3)</sup>			
Manta 400 i			08.81	07.86		G1020015	20939 15,8 /WD	DEL	























### Classic PKW OPEL OMEGA A / Vauxhall Carlton (87-93)

	1.8		L1019854	08.86		G1020015		20939 15,8 /WD	DEL
	2.3 D		L1019854	08.86					
	2.3 TD		L1019854	08.86					
2.0			K1000098	08.86		G1020258		21190 17,5 +WD	ATE
						G1020015		20939 15,8 /WD	DEL
1.8			L1019855	08.93		G1020258		21190 17,5 +WD	ATE
	2.0		K1000099	08.93					

<sup>1)</sup> + scatola cambio automatico / + transmission automatique / + cambio automático / + Automatikgetriebe



















<sup>2)</sup> + fr.rinforzato/+ scatola camb.velocità / + frein renforcé/ + transm.mécanique / + freno reforzado/ + camb.de velocidad / + verstärkte Bremse/+ Schaltgetr.



















<sup>3)</sup> + pinza freno flottante / + étriers à griffe / + pinza de puno / + Faustsattel



















									
<b>Classic PKW OPEL OMEGA A / Vauxhall Carlton (87-93)</b>									
	2.3 D 2.3 TD 2.4	L1019855 L1019855 K1000099		08.93 08.93 08.93			G1020258	21190 17,5 +WD	ATE
	1.8 Caravan 1.8 Saloon 2.0 Caravan 2.0 Saloon 2.3 D Caravan 2.3 D Saloon 2.3 TD Caravan 2.3 TD Saloon 2.4 2.6 3.0 3.0 24V	K1000099 K1000099 K1000099 K1000099 K1000099		08.86 08.93 08.93 08.93 08.86 08.93 08.86 08.93 08.86 08.93 08.86 08.93 08.88 08.93 09.90 08.93 08.86 08.93 08.89 08.93			G1020271	21050 15,0	ATE
<b>Classic PKW OPEL REKORD E / Vauxhall Carlton (77-86)</b>									
	all types			01.79 12.86 + fist type calipers <sup>1)</sup>			G1020015	20939 15,8 /WD	DEL
<b>Classic PKW OPEL SENATOR B / Vauxhall Royal (88-93)</b>									
	2.5 2.6 3.0 3.0 24V			09.90 09.93 08.90 09.93 09.87 09.93 08.89 09.93			G1020271	21050 15,0	ATE
<b>Classic PKW PEUGEOT J5 (81-94)</b>									
	1.8 1.9 D 2.0 2.0 2.5 D 2.5 TD	51 55 58 54 70		11.81 06.94 10.87 06.94 11.81 06.94 11.81 06.94 11.81 06.94 -1,8 t 10.87 06.94 -1,8 t			G1020147	20741 19,0 +/W/S	LUC
<b>Classic PKW PEUGEOT 104 (72-87)</b>									
	1.0 1.1 1.1 1.1 GR/SR 1.2 1.4	37 48 42		10.72 09.83 10.78 09.83 09.73 09.79 09.79 09.83 09.80 09.83 09.80 09.83			G1020065	20140 14,0 +/WD	BDX
	1.1 1.1 GR/SR 1.4	37 42		10.83 09.87 10.83 09.84 10.83 09.85			G1020065	20140 14,0 +/WD	BDX
<b>Classic PKW PEUGEOT 205 (83-90)</b>									
	1.0 1.1 1.4 1.6 1.6 1.6 1.6 GTI/CTI 1.7 D 1.9 D	33 58 65 44		01.83 08.90 01.83 08.90 01.83 08.90 08.86 08.90 10.87 08.90 + autom.transmission <sup>2)</sup> 05.90 08.90 + autom.transmission <sup>2)</sup> 01.84 08.90 07.83 08.90 09.88 08.90			G1020214 G1020213	20905 18,0 +/WI 20989 17,7 +/WI	BDX LUC
	1.1 i 1.3 Rallye 1.4 i 1.9 GTI/CTI	75		09.89 08.90 09.87 08.90 09.88 08.90 04.89 08.90			G1020214 G1020213	20905 18,0 +/WI 20989 17,7 +/WI	BDX LUC
	1.0 1.1 1.1 i 1.4 1.4 i 1.6 1.7 D 1.9 D	33 44		01.83 08.90 01.83 08.90 07.89 08.90 01.83 08.90 07.88 08.90 08.86 02.87 07.83 08.90 09.88 08.90			G2110187	247 10,0 9,0 +S +C	
	1.9 GTI 1.9 GTI	88 94		09.88 08.90 10.86 08.88			G2120132	247 20,4 18,5 V +S +C	
	1.9 GTI 1.9 GTI	88 94		09.88 08.90 10.86 08.88			G1020216	20973 11,0 +	BDX
<b>Classic PKW PEUGEOT 305 (77-90)</b>									
	1.3 1.5 1.6 1.6 GT 1.8 1.8 D 1.9 1.9 D 1.9 i	59 44 75 72		10.82 08.86 10.82 07.90 10.82 12.88 07.84 08.87 11.82 12.88 11.82 12.88 10.82 10.87 10.82 12.88 10.86 12.88			G1020214	20905 18,0 +/WI	BDX

<sup>1)</sup> + pinza freno flottante / + étriers à griffe / + pinza de puno / + Faustsättel

<sup>2)</sup> + scatola cambio automatico / + transmission automatique / + cambio automático / + Automatikgetriebe

							
<b>Classic PKW PEUGEOT 305 (77-90)</b>							
	1.6 GT 1.9 1.9 i	75 72		07.84 10.82 10.86	08.87 10.87 12.88	G2120133	266 20,5 18,5 V +S +C
<b>Classic PKW PEUGEOT 405 (87-92)</b>							
	1.4 i 1.6 1.8 D Estate 1.8 TD 1.9 1.9 D	47 66 70	S 70536851 S 70536851	01.87 09.87 03.88 09.88 09.87 05.88	08.92 08.92 08.92 + ⊕ 08.90 09.87 05.88	G1020214	20905 18,0 +/WI BDX
	1.8 TD 1.9 1.9 1.9 1.9 D 1.9 i 1.9 i 1.9 Mi 16 1.9 Mi 16	66 70 80 93 70 77 88 108 116	S 70536852 S 70536852	09.90 08.92 09.88 07.87 08.92 09.87 09.88 05.88 09.87	08.92 08.92 08.92 08.92 08.92 08.88 08.92 08.92 12.88	G2120133	266 20,5 18,5 V +S +C
	1.9 Mi 16 X4 1.9 X4	108 80		05.88 09.88	08.92 08.92	G1020201	20961 15,2 /WD/Acc/S LUC
	1.9 Mi 16 X4 1.9 X4	108 80		05.88 09.88	08.92 08.92	G2110187	247 10,0 9,0 +S +C
<b>Classic PKW RENAULT ALPINE A310 (77-84)</b>							
	2.7 (2700VA)		0047708	01.77	- ⊕	G1020065	20140 14,0 +/WD BDX
<b>Classic PKW RENAULT ESPACE I (J/S 11_) (84-90)</b>							
	2.0 (J/S112) 2.0 (J/S112) 2.0 i (J116) 2.0 i Quadra (J116) 2.1 TD (J/S115) 2.2 (J117) 2.2 Quadra 2.2 Quadra (J117)	74 80 87 87 65 79 81 79		01.88 07.84 01.89 03.88 10.84 07.86 06.87 01.88	12.90 12.90 12.90 12.92 12.90 12.90 12.87 12.90	G1020214 G1020501	20905 18,0 +/WI BDX 21463 18,2 /WI/S LUC
<b>Classic PKW RENAULT FUEGO (80-92)</b>							
	1.4 (R1360) 1.6 (R1361) 1.6 (R1362) 2.0 (R1363) 1.6 T (R1365) 2.1 (R1366)			01.80 01.83 01.80 01.81 01.84 01.83	12.85 12.85 12.85 12.85 12.85 12.84	G1020214 G1020501 G1020214 G1020501	20905 18,0 +/WI BDX 21463 18,2 /WI/S LUC 20905 18,0 +/WI BDX 21463 18,2 /WI/S LUC
<b>Classic PKW RENAULT R4 (62-90)</b>							
	1.0 (R112C) 1.1 (R1128) 1.1 (R2370) 1.1 (S 128) 1.1 (R210B) 1.1 (R239B)			01.87 01.83 01.83 06.89 01.83 01.83	06.90 06.90 + ⊕ 12.86 06.90 06.88 - ⊕ 06.88 - ⊕	G1020065 G1020065	20140 14,0 +/WD BDX 20140 14,0 +/WD BDX
<b>Classic PKW RENAULT R5 SUPER (85-96)</b>							
	1.0 (B/C/S 400) 1.1 (B/C/- 40H) 1.1 (B/C/S 401) 1.2 (B/C/S 40F) 1.4 (-/C/- 405) 1.4 (B/C/- 402) 1.4 (B/C/- 403) 1.4 (B/C/- 407) 1.4 (B/C/- 40J) 1.4 (B/C/- 40M) 1.6 (B/C/S 404) 1.7 (-/C/- 409) 1.7 (B/C/- 408) 1.7 (B/C/- 40G) 1.7 (B/C/- 40K)			01.85 06.87 01.85 01.86 01.85 01.85 01.85 01.85 06.87 06.87 01.86 01.87 01.87 06.87 06.87	08.90 08.90 03.95 08.90 08.90 08.90 12.96 08.90 08.90 12.96 08.91 03.95 03.95 03.95	G1020219 G1020214 G1020501	21097 15,0 +/WI BDX 20905 18,0 +/WI BDX 21463 18,2 /WI/S LUC
	1.0 (B/C/S 400) 1.1 (B/C/- 40H) 1.1 (B/C/S 401) 1.2 (B/C/S 40F) 1.4 (B/C/- 402) 1.4 (B/C/- 403) 1.4 (B/C/- 407) 1.4 (B/C/- 40J) 1.4 (B/C/- 40M) 1.6 (B/C/S 404) 1.7 (B/C/- 408)			01.85 06.87 01.85 01.85 01.85 01.85 06.87 06.87 01.85 01.85 01.87	08.90 08.90 03.95 08.90 08.90 08.90 12.96 08.90 08.90 12.96 03.95	G2108104 G2112116	238 8,2 7,0 +S +C 238 12,0 10,5 +S +C

								
<b>Classic PKW RENAULT R5 SUPER (85-96)</b>								
	1.4 (-/C/- 405) 1.7 (-/C/- 409) 1.7 (B/C/- 40G) 1.7 (B/C/- 40K)			01.85 08.90 01.87 08.91 06.87 03.95 06.87 03.95		G2120125		238 20,1 17,7 V +S +C
	1.4 (-/C/- 405) 1.7 (-/C/- 409)			01.85 08.90 01.87 08.91		G1020216		20973 11,0 + BDX
<b>Classic PKW RENAULT R5 (72-84)</b>								
	1.0 (R1222) 1.0 (R1392) 1.1 (R1227) 1.1 (R1397) 1.3 (R1224) 1.3 (R1225) 1.3 (R1395) 1.3 (R2387) 1.4 (R1229) 1.4 (R1399)	1185269 0026816 0411329 0503339 0497566 0399951 0048701 0052900 0083872 0026223		12.84 12.84 12.84 12.84 12.84 12.84 12.84 12.84 12.84 12.84		G1020065		20140 14,0 +/WD BDX
	1.4 (R1223) 1.4 (R122B)			01.76 12.81 01.82 12.84		G1020065		20140 14,0 +/WD BDX
<b>Classic PKW RENAULT R6 (69-80)</b>								
	1.1 (R1181)			01.70 12.80		G1020065		20140 14,0 +/WD BDX
<b>Classic PKW RENAULT R9 (82-89)</b>								
	1.1 (L421) 1.2 (L42S) 1.4 (L422) 1.4 (L423) 1.4 (L42C) 1.4 (L42R) 1.4 i (L42A) 1.6 (L424) 1.7 (L426) 1.7 (L42L) 1.7 i (L42F)	35 40 44 44 44 49 40 59 55 54		01.82 06.87 01.86 11.89 01.82 12.86 01.82 11.89 10.86 11.89 10.86 11.89 06.87 11.89 01.83 11.89 01.85 06.87 10.86 11.89 01.85 11.89		G1020214 G1020501		20905 18,0 +/WI BDX 21463 18,2 /WI/S LUC
	1.4 T (L425) 1.7 (L42D) 1.7 (L42N) 1.7 i (L42E)			01.85 11.89 06.87 11.89 10.86 11.89 10.86 11.89		G1020501		21463 18,2 /WI/S LUC
	1.1 (L421) 1.2 (L42S) 1.4 (L422) 1.4 (L423) 1.4 (L42C) 1.4 (L42R) 1.4 i (L42A) 1.6 (L424) 1.7 (L426) 1.7 (L42L) 1.7 i (L42F)	35 0084201 40 44 0170421 44 49 40 59 55 54		06.87 01.86 11.89 12.86 01.82 11.89 10.86 11.89 10.86 11.89 06.87 11.89 01.83 11.89 01.85 06.87 10.86 11.89 01.85 11.89		G2112116		238 12,0 10,5 +S +C
	1.4 T (L425) 1.7 (L42D) 1.7 (L42N) 1.7 i (L42E)			01.85 11.89 06.87 11.89 10.86 11.89 10.86 11.89		G2120125		238 20,1 17,7 V +S +C
	1.4 T (L425)			10.86 11.89		G1020216		20973 11,0 + BDX
<b>Classic PKW RENAULT R11 (83-89)</b>								
	1.1 (-/S 371) 1.1 (B/C/- 371) 1.2 (B/C/S 37S) 1.4 (-/S 373) 1.4 (B/C/- 372) 1.4 (B/C/- 373) 1.4 (B/C/- 37C) 1.4 (B/C/- 37R) 1.4 i (B/C/- 37A) 1.6 D (B/C/S 374) 1.7 (B/C/- 376) 1.7 (B/C/- 37L) 1.7 i (B/C/- 37F)	35 35 40 44 44 44 49 40 59 54 55		01.84 10.86 01.83 06.87 01.86 11.89 01.85 10.86 01.83 12.86 01.83 11.89 10.86 11.89 06.87 11.89 06.87 11.89 01.84 11.89 01.84 06.87 10.86 11.89 01.85 11.89		G1020214 G1020501		20905 18,0 +/WI BDX 21463 18,2 /WI/S LUC
	1.4 T (B/C/- 375) 1.7 (B/C/- 37D) 1.7 (B/C/- 37N) 1.7 i (B/C/- 37E)	64 65 65 69		01.84 11.89 06.87 11.89 10.86 11.89 10.86 11.89		G1020501		21463 18,2 /WI/S LUC
	1.1 (-/S 371) 1.1 (B/C/- 371) 1.2 (B/C/S 37S) 1.4 (-/S 373) 1.4 (B/C/- 372) 1.4 (B/C/- 373)	35 35 40 44		01.84 10.86 01.83 06.87 01.86 11.89 01.85 10.86 01.83 12.86 01.83 11.89		G2112116		238 12,0 10,5 +S +C

									
<b>Classic PKW RENAULT R11 (83-89)</b>									
	1.4 (B/C/- 37C)	44		10.86	11.89		G2112116		238 12,0 10,5 +S +C
	1.4 (B/C/- 37R)	49		06.87	11.89				
	1.4 i (B/C/- 37A)			06.87	11.89				
	1.6 D (B/C/S 37A)	40		01.84	11.89				
	1.7 (B/C/- 376)	59		01.84	06.87				
	1.7 (B/C/- 37L)	54		10.86	11.89				
	1.7 i (B/C/- 37F)	55		01.85	11.89				
	1.4 T (B/C/- 375)			01.84	11.89		G2120125		238 20,1 17,7 V +S +C
	1.7 (B/C/- 37D)	64		06.87	11.89				
	1.7 (B/C/- 37N)	65		10.86	11.89				
	1.7 i (B/C/- 37E)	69		10.86	11.89				
	1.4 T (B/C/- 375)			10.86	11.89		G1020216		20973 11,0 + BDX
<b>Classic PKW RENAULT R12 (70-80)</b>									
	1.3 (R1170)	1460412	1624841			+ MEX	G1020065		20140 14,0 +/WD BDX
	1.3 (R1170)			01.70	12.80				
	1.3 (R1330)	0317359	0376767			+ MEX			
	1.4 (R1179)		0007424	01.76		+ CAN			
	1.4 (R1338)	0009901	0017282			+ CAN			
<b>Classic PKW RENAULT R14 (76-83)</b>									
	1.2 (R1210)			01.76	12.83		G1020065		20140 14,0 +/WD BDX
	1.4 (R1212)			01.80	12.83				
	1.4 (R1213)			01.82	12.83				
<b>Classic PKW RENAULT R15 (72-79)</b>									
	1.3 (R1300)			01.72	12.79		G1020065		20140 14,0 +/WD BDX
	1.6 (R1304)			01.72	12.76	+ CAN			
	1.6 (R1308)			01.72	12.76	+ USA			
<b>Classic PKW RENAULT R17 (72-80)</b>									
	1.6 (R1312)	0008153	0030470				G1020065		20140 14,0 +/WD BDX
	1.6 (R1314)			01.72	12.75				
	1.6 (R1316)			01.72	12.75				
	1.6 (R1317)			01.72	12.78				
	1.6 (R1318)			01.76	12.80				
	1.6 (R1322)			01.72	12.76				
	1.6 (R1323)			01.72	12.77				
	1.6 (R1324)			01.72	12.75				
	1.6 (R1326)			01.72	12.80				
	1.6 (R1327)			01.76	12.78				
	1.6 (R1328)			01.76	12.78				
<b>Classic PKW RENAULT R18 Van (79-86)</b>									
	1.4 (R2350)	47		01.83	07.86		G1020214 G1020501		20905 18,0 +/WI BDX 21463 18,2 /WI/S LUC
	2.1 D (R2354)	49		01.83	07.86		G1020214		20905 18,0 +/WI BDX
<b>Classic PKW RENAULT R18 Saloon (78-86)</b>									
	1.4 (R1340)	47		01.83	07.86		G1020214 G1020501		20905 18,0 +/WI BDX 21463 18,2 /WI/S LUC
	1.6 (R1341)	54		01.83	07.86				
	2.0 (R1343)	77		01.83	07.86				
	2.1 D (R1344)	49		01.83	07.86				
	2.1 D (R1346)	53		11.81	07.86				
	1.6 TS (R1342)	71		01.83	07.86		G1020501		21463 18,2 /WI/S LUC
	1.6 Turbo (R1345)	92		01.83	07.86				
<b>Classic PKW RENAULT R18 Variable (79-86)</b>									
	1.4 (R1350)	47		01.83	07.86		G1020214 G1020501		20905 18,0 +/WI BDX 21463 18,2 /WI/S LUC
	1.6 (R1351)	54		01.83	07.86				
	1.6 4x4 (R1351)	54		01.83	07.86				
	2.0 (R1353)	77		01.83	07.86				
	2.0 4x4 (R1353)	76		05.83	12.86				
	1.6 TS (R1352)	71		01.83	07.86		G1020501		21463 18,2 /WI/S LUC
	1.6 Turbo (R1355)	92		01.83	07.86				
	2.1 D (R1354)	49		01.83	07.86		G1020214		20905 18,0 +/WI BDX
2.1 D (R1356)	53		01.83	07.86					
<b>Classic PKW RENAULT R20 (76-84)</b>									
	1.6 (R1271)			01.76	05.80		G1020065		20140 14,0 +/WD BDX
	1.6 (R1271)			06.80	12.81		G1020214		20905 18,0 +/WI BDX
	2.0 (R1272)			01.81	12.84	+ S	G1020214		20905 18,0 +/WI BDX
	2.0 (R1277)			01.81	12.84	+ D	G1020501		21463 18,2 /WI/S LUC
	2.1 (R1276)			01.80	12.84				
<b>Classic PKW RENAULT R21 Saloon (B48/L48_) (86-93)</b>									
	1.4 (B/L 48D)	51		06.88	12.92		G1020214 G1020501		20905 18,0 +/WI BDX 21463 18,2 /WI/S LUC
	1.7 (B/L 481)	55		01.86	12.92				
	1.7 (L 48M)	54		10.87	05.90				
	1.7 i (B 48F)	54		08.86	12.93				
	1.6 (B/L 48U)			06.88	12.93		G1020501		21463 18,2 /WI/S LUC
	1.7 (B/L 482)	65		01.86	12.92				
	1.7 (B/L 484)			06.90	12.93				





Classic PKW RENAULT R21 Saloon (B48/L48_) (86-93)										
	1.7 (B/L 48J) 1.7 (L 48N) 1.7 i (B/L 48E) 1.9 D (B/L 48H) 1.9 D (B/L 48I)	64 66 47 47		01.87 10.87 08.86 05.89 04.92	05.91 05.90 12.93 12.92 12.93		G1020501		21463 18,2 /W/S	LUC
	1.4 (B/L 48D) 1.7 (B/L 48I)	51 55		06.88 01.86	12.92 12.92		G2112116		238 12,0 10,5 +S +C	
	1.6 (B/L 48U) 1.7 (B/L 482) 1.7 (B/L 484) 1.7 (B/L 48J) 1.7 (L 48M) 1.7 (L 48N) 1.7 i (B 48F) 1.7 i (B/L 48E) 1.9 D (B/L 48H) 1.9 D (B/L 48I)	65 54 64 54 66 47 47		06.88 01.86 06.90 01.87 10.87 10.87 08.86 08.86 05.89 04.92	12.93 12.92 12.93 05.91 05.90 05.90 12.93 12.93 12.92 12.93		G2120125		238 20,1 17,7 V +S +C	
	2.0 i (B/L 483) 2.0 i (B/L 48C) 2.0 i (B/L 48R) 2.0 i (B/L 48Y) 2.0 i (L 48Q) 2.0 T (L 485) 2.0 T (L 48L) 2.1 D (B 480) 2.1 D (B/L 480) 2.1 TD (B 487) 2.1 TD (B/L 488) 2.1 TD (B/L 48A) 2.1 TD (L 48P) 2.2 i (B/L 48K)	88 99 99 53 51 65 65 65 65 79		03.87 06.90 05.89 05.89 05.89 06.87 05.89 04.92 04.92 06.91 03.87 04.92 07.91 03.87	12.92 12.93 12.93 03.92 03.92 03.92 12.93 12.92 + ABS 12.93 + ABS 12.93 + ABS 10.92 + ABS 12.93 + ABS 03.92 + ABS 12.93 + ABS		G1020327		20410 15,0 +	BRE
Classic PKW RENAULT R25 (84-92)										
	2.0 (B297) 2.0 i (B292) 2.0 i (B294) 2.0 i (B29H) 2.1 D (B296) 2.1 TD (B290) 2.1 TD (B29W) 2.2 i (B29B) 2.2 i (B29B) 2.2 i (B29B) 2.2 i (B29E) 2.2 i (B29E) 2.2 i (B29E) 2.2 i (B29B) 2.2 i (B29E) 2.5 T (B295) 2.5 T (B29G) 2.7 V6 (B298) 2.8 V6 (B293) 2.8 V6 (B29A) 2.8 V6 (B29F)			01.84 06.88 02.90 01.87 01.84 01.84 06.89 06.88 06.87 01.86 06.88 06.87 01.84 01.86 01.85 06.89 01.84 06.87 01.87 06.87	12.92 12.92 12.92 12.92 12.92 12.92 02.90 12.92 05.88 + ABS 05.88 - ABS 06.89 05.88 + ABS 05.88 - ABS 05.87 + ABS 05.87 + ABS 06.89 12.92 05.89 06.89 05.88 12.92		G1020501		21463 18,2 /W/S	LUC
	2.2 i (B29B) 2.2 i (B29E) 2.5 T (B295) 2.5 T (B29G) 2.7 V6 (B298) 2.8 V6 (B293) 2.8 V6 (B29A) 2.8 V6 (B29F)			01.86 01.84 01.85 06.89 01.84 06.87 01.87 06.87	05.87 + ABS 05.87 + ABS 06.89 12.92 05.89 06.89 05.88 12.92		G1020326		21388 18,0 +/W/S	LUC
Classic PKW RENAULT R30 (75-84)										
	2.1 TD (R1270)	63		01.82	12.84		G1020501		21463 18,2 /W/S	LUC
Classic PKW SEAT RONDA (83-86)										
	1.2 1.5 1.6 1.7 D			06.83 09.85 06.83 06.83	07.86 07.86 08.85 07.86		G1020141		20775 18,0 /W	BDX
Classic PKW TALBOT SAMBA (81-86)										
	0.9 1.1 1.2 Rallye 1.4 1.4 Convertible 1.4 Rallye			01.81 01.81 01.83 01.81 01.81 01.83	09.83 09.83 09.83 09.83 09.83 09.83		G1020065		20140 14,0 +/WD	BDX
Classic PKW VOLKSWAGEN CADDY I (83-92)										
	1.5 1.6 1.6 D 1.8			08.82 08.83 08.82 08.85	07.83 07.92 07.92 07.92		G1020009		20887 19,7 +/Acc	VW
	1.5 1.6 1.6 D 1.8			08.82 08.83 08.82 08.85	07.83 07.92 07.92 07.92		G2112106		239 12,0 10,0 +S +C	

Classic PKW VOLKSWAGEN CORRADO (88-95)										
	1.8 16V 2.0 2.0 16V			04.89 04.93 08.91	07.92 07.95 07.95		G1020273		20168 16,0 /S	LUC
	1.8 G60 2.9 VR6			10.88 08.91	09.93 07.95		G1020274		20168 19,3 /S	LUC
	1.8 16V 2.0 2.0 16V			04.89 04.93 08.91	07.92 07.95 07.95		G2120128		256 20,0 18,0 V L +S +C	
	1.8 16V 1.8 G60 2.0 2.0 16V 2.9 VR6		50-P-009000 50-P-009000	04.89 10.88 04.93 08.91	07.92 10.88 07.95 07.95		G1020201		20961 15,2 /WD/Acc/S	LUC
	1.8 G60 2.9 VR6	50-P-009001 50-P-009001		09.93 07.95			G1020345		20961 17,0 /WD/Acc/S	LUC
	1.8 16V 1.8 G60 2.0 2.0 16V			04.89 10.88 04.93 08.91	07.92 09.93 07.95 07.95		G2110111	without sensor ring <sup>1)</sup>	226 10,0 8,0 +C	
Classic PKW VOLKSWAGEN DERBY/POLO Notchback (77-88)										
	0.9 1.1 1.3			01.77 01.77 01.77	09.81 09.81 09.81		G1020097		20228 15,3	ATE
	1.0 1.1 1.3		...-F-127903 ...-F-127903 ...-F-127903	10.81 10.81 10.81			G1020097		20228 15,3	ATE
	1.0 1.1 1.3 1.3 D	...-F-127904 ...-F-127904 ...-F-127904		12.88 12.88 12.88 08.86			G1020025		20889 17,3 /Acc	VW
	1.0 1.1 1.3 1.3 D			10.81 10.81 10.81 08.86	12.88 12.88 12.88 12.88		G2110151		239 10,0 8,0 +S +C	
Classic PKW VOLKSWAGEN GOLF I Convertible (79-93)										
	1.1 1.5 1.6			01.79 09.79 08.83	07.83 07.83 12.92		G1020097 G1020009		20228 15,3 20887 19,7 +/Acc	ATE VW
	1.6 GLI 1.6 GLI 1.8			07.79 09.79 08.82	07.80 07.82 08.93	+ floating calipers <sup>3)</sup> + fist type calipers <sup>2)</sup>	G1020097 G1020010		20228 15,3 20887 15,3 +/Acc	ATE VW
	1.1 1.5 1.6 1.6 GLI 1.8			01.79 01.79 08.83 07.79 08.82	07.83 07.83 12.92 07.82 08.93		G2110151 G2112106 G2120123		239 10,0 8,0 +S +C 239 12,0 10,0 +S +C 239 20,0 18,0 V L +S +C	
Classic PKW VOLKSWAGEN GOLF I (74-83)										
	1.1 1.5 D			08.75 08.76	02.78 02.78		G1020097		20228 15,3	ATE
	1.1 1.3 1.5 D 1.6 D			03.78 08.79 03.78 08.80	10.83 10.83 07.80 10.83		G1020097		20228 15,3	ATE
	1.5 1.6 1.6 TD			08.78 08.78 03.82	10.83 10.83 10.83	+ fist type calipers <sup>2)</sup> + fist type calipers <sup>2)</sup>	G1020009		20887 19,7 +/Acc	VW
	1.6 GTI 1.6 GTI 1.8 GTI			06.76 04.79 08.82	07.80 07.82 10.83	+ floating calipers <sup>3)</sup> + fist type calipers <sup>2)</sup>	G1020097 G1020010		20228 15,3 20887 15,3 +/Acc	ATE VW
	1.1 1.5 1.6 1.6 TD 1.7			04.74 02.74 08.75 03.82 08.80	07.75 10.83 10.83 10.83 10.83		G2112106		239 12,0 10,0 +S +C	
	1.1 1.3 1.5 D 1.6 D			08.75 08.79 08.76 08.80	10.83 10.83 07.80 10.83		G2110151		239 10,0 8,0 +S +C	
	1.6 GTI 1.8 GTI			06.76 08.82	07.82 10.83		G2120123		239 20,0 18,0 V L +S +C	
Classic PKW VOLKSWAGEN JETTA I (79-83)										
	1.1 1.3 1.6 D			08.79 08.79 08.80	07.83 07.83 07.83		G1020097		20228 15,3	ATE
	1.5 1.6 1.6 D 1.6 TD 1.7			08.79 08.80 08.80 03.82 08.80	07.83 07.83 07.83 07.83 07.83	+ floating calipers/ + fist type calipers <sup>2)</sup> + fist type calipers <sup>2)</sup> + floating calipers/ + fist type calipers <sup>5)</sup>	G1020009		20887 19,7 +/Acc	VW















<sup>1)</sup> senza sensori / sans secours ABS / sin anillo sensor ABS / ohne Sensoring

<sup>2)</sup> + pinza freno flottante / + étriers à griffe / + pinza de puno / + Faustsattel

<sup>3)</sup> + pinze flottante / + étriers flottant / + pinzas flotante / + Schwimmsattel

<sup>4)</sup> + pinze flottante/ - <sup>4)</sup> / + étriers flottant/ - <sup>4)</sup> / + pinzas flotante/ - <sup>4)</sup> / + Schwimmsattel/ - <sup>4)</sup>

<sup>5)</sup> + <sup>5)</sup> / + pinza flottante / + <sup>5)</sup> / + étriers à griffe / + <sup>5)</sup> / + pinza de puno / + <sup>5)</sup> / + Faustsattel

															
<b>Classic PKW VOLKSWAGEN JETTA I (79-83)</b>															
	1.6 I 1.8							08.79 08.82	07.82 07.83			G1020010		20887 15,3 +/Acc	VW
	1.1 1.3 1.6 D							08.79 08.79 08.80	07.83 07.83 07.83			G2110151		239 10,0 8,0 +S +C	
	1.5 1.6 1.6 D 1.6 TD 1.7							08.79 08.80 08.80 03.82 08.80	07.83 07.83 07.83 07.83 07.83			G2112106		239 12,0 10,0 +S +C	
	1.6 i 1.8							08.79 08.82	07.82 07.83			G2120123		239 20,0 18,0 V L +S +C	
<b>Classic PKW VOLKSWAGEN JETTA II (84-92)</b>															
	1.3 1.3 1.3 1.6 1.6 D 1.6 D 1.6 D							16-E-855000 08.83 08.83 08.83 03.86 16-E-855000 01.84 08.86 01.84	07.84 07.86 07.86 07.86 07.92 07.86			G1020025		20889 17,3 /Acc	VW
	1.3 1.3 1.6 1.6 D 1.6 D 1.6 D 1.6 TD 1.8 1.8 1.8 Syncro		53					08.89 08.86 01.84 08.86 01.84 01.84 01.84 08.86 08.84 08.87	07.92 07.86 07.92 07.86 07.87 07.86 07.92 07.92 07.92 07.92			G1020009		20887 19,7 +/Acc	VW
	1.8 1.8 1.8 1.8 1.8 16V 1.8 16V		62 66 77 79 82		16-E-855001			07.92 07.92 08.88 08.85 01.84 1G-KW240000 08.86 1G-KB075000 08.86	+ ABS + ABS + + - + ABS + ABS + - ABS - ABS			G1020010		20887 15,3 +/Acc	VW
	1.8 16V 1.8 16V		62 66		16-E-855001			07.92 07.92	+ ABS + ABS			G1020273		20168 16,0 /S	LUC
	1.3 1.3 1.3 1.6 1.6 D 1.6 D 1.6 D		53					16-E-855000 08.83 08.86 08.83 03.86 16-E-855000 01.84 08.86 01.84	07.92 07.86 07.86 07.86 07.92 07.86			G2110151		239 10,0 8,0 +S +C	
	1.3 1.3 1.6 1.6 D 1.6 D 1.6 D 1.6 TD 1.8 1.8 1.8 Syncro		53					08.89 08.86 01.84 08.86 01.84 01.84 01.84 08.86 08.84 08.87	07.92 07.86 07.92 07.86 07.92 07.86 07.92 07.92 07.92 07.92			G2112106		239 12,0 10,0 +S +C	
	1.8 1.8 1.8 1.8 1.8 16V 1.8 16V		62 66 77 79 82		16-E-855001			07.92 07.92 08.88 08.85 01.84 1G-KW240000 08.86 1G-KB075000 08.86	+ ABS + ABS + + - + ABS + ABS			G2120123		239 20,0 18,0 V L +S +C	
	1.8 16V 1.8 16V		62 66		16-E-855001			07.92 07.92	+ ABS + ABS			G2120128		256 20,0 18,0 V L +S +C	
	1.8 1.8 1.8 1.8 16V 1.8 GT		62 66 82		16-E-855001			07.92 07.92 01.84 08.86 08.85	+ ABS + ABS + + ABS + ABS			G1020201		20961 15,2 /WD/Acc/S	LUC
	1.8 1.8 1.8 16V 1.8 GT		62 66 82		16-E-855001			07.92 07.92 01.84 08.86	+ ABS + ABS + + ABS			G2110111	without sensor ring <sup>3)</sup>	226 10,0 8,0 +C	
<b>Classic PKW VOLKSWAGEN PASSAT Saloon (85-88)</b>															
	1.3 1.6 1.6 D 1.6 TD							08.84 08.84 08.84 08.84	07.86 03.88 03.88 03.88			G1020009		20887 19,7 +/Acc	VW

1) + scatola cambio velocità / + transmission mécanique / + cambio de velocidad / + Schaltgetriebe  
2) + scatola cambio automatico / + transmission automatique / + cambio automático / + Automatikgetriebe  
3) senza sensori / sans secours ABS / sin anillo sensor ABS / ohne Sensorring



Classic PKW VOLKSWAGEN PASSAT Saloon (85-88)										
	1.8			08.84	03.88		G1020009		20887 19,7 +/Acc	VW
	2.0			08.84	03.88		G1020010		20887 15,3 +/Acc	VW
	2.2	85		08.85	03.88					
	2.2	100		01.85	03.88		G1020273		20168 16,0 /S	LUC
	1.3			08.84	07.86		G2112106		239 12,0 10,0 +S +C	
	1.6			08.84	03.88					
	1.6 D			08.84	03.88					
	1.6 TD			08.84	03.88					
	1.8			08.84	03.88					
	2.0			08.84	03.88		G2120123		239 20,0 18,0 V L +S +C	
	2.2	85		08.85	03.88					
	2.2	100		01.85	03.88		G2120128		256 20,0 18,0 V L +S +C	
	2.2	100		01.85	03.88		G1020201		20961 15,2 /WD/Acc/S	LUC
	2.2	100		01.85	03.88		G2110111	without sensor ring <sup>1)</sup>	226 10,0 8,0 +C	
Classic PKW VOLKSWAGEN PASSAT Variant (73-84)										
	1.3			02.80	07.84		G1020009		20887 19,7 +/Acc	VW
	1.5 D			02.80	07.80	+ fist type calipers <sup>2)</sup>				
	1.6			02.80	07.84					
	1.6 D			02.79	07.84					
	1.6 i			02.80	07.80	+ S J / + fist type caliper <sup>3)</sup>				
	1.6 TD			12.81	07.84					
	1.8			01.83	07.84					
	1.8 i			12.83	07.84		G1020010		20887 15,3 +/Acc	VW
	1.9			01.81	07.83					
	2.0			08.83	07.84					
	2.2			01.81	07.83	+ S				
	1.3			05.73	07.84		G2112106		239 12,0 10,0 +S +C	
	1.5			05.73	08.75					
	1.5 D			08.77	07.80					
	1.6			09.75	07.84					
	1.6 D			02.79	07.84					
	1.6 i			06.78	07.80	+ S J				
	1.6 TD			12.81	07.84					
1.8			01.83	07.84						
	1.8 i			12.83	07.84		G2120123		239 20,0 18,0 V L +S +C	
	1.9			01.81	07.83					
	2.0			08.83	07.84					
	2.2			01.81	07.83	+ S				
Classic PKW VOLKSWAGEN PASSAT Variant (85-88)										
	1.3			08.84	07.86		G1020009		20887 19,7 +/Acc	VW
	1.6			08.84	03.88					
	1.6 D			08.84	03.88					
	1.6 TD			08.84	03.88					
	1.8			08.84	03.88					
	2.0			08.84	03.88		G1020010		20887 15,3 +/Acc	VW
	2.2	85		08.85	03.88					
	1.8 Syncro			01.86	07.88		G1020273		20168 16,0 /S	LUC
	2.0 Syncro			08.84	07.88					
	2.2	100		01.85	03.88					
	2.2 Syncro			08.84	07.88					
	1.3			08.84	07.86		G2112106		239 12,0 10,0 +S +C	
	1.6			08.84	03.88					
	1.6 D			08.84	03.88					
	1.6 TD			08.84	03.88					
	1.8			08.84	03.88					
	2.0			08.84	03.88		G2120123		239 20,0 18,0 V L +S +C	
	2.2	85		08.85	03.88					
	1.8 Syncro			01.86	07.88		G2120128		256 20,0 18,0 V L +S +C	
	2.0 Syncro			08.84	07.88					
	2.2 Syncro	100		01.85	03.88					
	2.2 Syncro			08.84	07.88					
	1.8 Syncro			01.86	07.88		G1020201		20961 15,2 /WD/Acc/S	LUC
	2.0 Syncro			08.84	07.88					
	2.2	100		01.85	03.88					
	2.2 Syncro			08.84	07.88					
	2.2	100		01.85	03.88		G2110111	without sensor ring <sup>1)</sup>	226 10,0 8,0 +C	
	1.8 Syncro			01.86	07.88		G2110151		239 10,0 8,0 +S +C	
	2.0 Syncro			08.84	07.88					
2.2 Syncro			08.84	07.88						
Classic PKW VOLKSWAGEN PASSAT/SANTANA Saloon (73-84)										
	1.3			05.73	02.78		G1020097		20228 15,3	ATE
	1.5 D			08.77	07.78	+ manual transmission <sup>4)</sup>				
	1.3			03.78	07.82		G1020097		20228 15,3	ATE
	1.5			05.73	08.75	+ manual transmission <sup>4)</sup>				
	1.5 D			08.78	07.80	+ manual transmission <sup>4)</sup>				
1.6 D			08.80	08.81	+ manual transmission <sup>4)</sup>					
	1.3			08.82	07.84		G1020009		20887 19,7 +/Acc	VW

<sup>1)</sup> senza sensori / sans secours ABS / sin anillo sensor ABS / ohne Sensorring

<sup>2)</sup> + pinza freno flottante / + étriers à griffe / + pinza de puno / + Faustsattel

<sup>3)</sup> + S J / + pinza flottante / + S J / + étriers à griffe / + S J / + pinza de puno / + S J / + Faustsattel

<sup>4)</sup> + scatola cambio velocità / + transmission mécanique / + cambio de velocidad / + Schaltgetriebe



### Classic PKW VOLKSWAGEN PASSAT/SANTANA Saloon (73-84)

	1.6 D			09.81	07.84	+ manual transmission <sup>1)</sup>	G1020009		20887 19,7 +/Acc	VW				
	1.6 TD			12.81	07.84									
	1.8 i			01.83	07.84	- GT								
	1.5 D			02.80	07.80	+ autom.transmission <sup>2)</sup>	G1020009		20887 19,7 +/Acc	VW				
	1.6			02.80	07.84	+ autom.transmission <sup>2)</sup>								
	1.6			02.80	07.84	+ manual transmission <sup>1)</sup>								
	1.6 D			08.80	07.84	+ autom.transmission <sup>2)</sup>								
	1.6 i			02.80	07.80	+ autom.transmission <sup>2)</sup>								
	1.6 TD			12.81	07.84	+ autom.transmission <sup>2)</sup>								
	1.8 GT			12.83	07.84	+ autom.transmission <sup>2)</sup>								
1.8 i			01.83	07.84	+ autom.transmission <sup>2)</sup>									
1.9			01.81	07.83	+ autom.transmission <sup>2)</sup>									
2.0			08.83	07.84	+ autom.transmission <sup>2)</sup>									
	1.6 i			02.79	07.80		G1020010		20887 15,3 +/Acc	VW				
	1.6 i			09.75	07.80	+ $\text{\textcircled{S}}$ $\text{\textcircled{J}}$								
	1.8 GT			12.83	07.84									
	1.9			01.81	07.83									
	2.0			08.83	07.84									
	2.2			01.81	07.83	+ $\text{\textcircled{S}}$								
	1.3			05.73	07.82						G2110151		239 10,0 8,0 +S +C	
	1.5 D			08.77	07.80									
	1.6 D			08.80	08.81									
		1.3			08.82	07.84						G2112106		239 12,0 10,0 +S +C
1.5				05.73	08.75									
1.6				09.75	07.84									
1.6 D				09.81	07.84									
1.6 TD				12.81	07.84									
1.8 i				01.83	07.84	- GT								
1.6 i				02.79	07.80									
	1.6 i			09.75	07.80	+ $\text{\textcircled{S}}$ $\text{\textcircled{J}}$	G2120123		239 20,0 18,0 V L +S +C					
	1.8 GT			12.83	07.84									
	1.9			01.81	07.83									
	2.0			08.83	07.84									
	2.2			01.81	07.83	+ $\text{\textcircled{S}}$								

### Classic PKW VOLKSWAGEN POLO I (75-81)

	0.9			04.75	09.81		G1020097		20228 15,3	ATE
	1.1			04.75	09.81					
	1.3			12.76	09.81					

### Classic PKW VOLKSWAGEN SCIROCCO I (74-83)

	1.6 i			01.76	07.80	+ floating calipers <sup>3)</sup>	G1020097		20228 15,3	ATE				
	1.1			08.78	07.80	+ fist type calipers <sup>4)</sup>								
	1.3			08.79	07.83	+ fist type calipers <sup>4)</sup>								
	1.5			08.78	07.83	+ fist type calipers <sup>4)</sup>								
	1.6			08.78	07.83	+ fist type calipers <sup>4)</sup>								
	1.7			08.80	07.83	+ $\text{\textcircled{J}}$ / + fist type calipers <sup>5)</sup>								
	1.6 i			04.79	07.82	+ fist type calipers <sup>4)</sup>	G1020010		20887 15,3 +/Acc	VW				
	1.8			08.82	07.83									
	1.1			01.74	07.80						G2112106		239 12,0 10,0 +S +C	
	1.3			08.79	07.83									
	1.5			01.74	07.83									
	1.6			01.75	07.83									
1.7			08.80	07.83	+ $\text{\textcircled{J}}$									
1.6 i			01.76	07.82										
1.8			08.82	07.83		G2120123		239 20,0 18,0 V L +S +C						

### Classic PKW VOLKSWAGEN SCIROCCO II (84-92)

	1.3			08.83	07.84		G1020009		20887 19,7 +/Acc	VW
	1.6			08.83	07.92					
	1.8			08.83	07.92					
	1.8 16V			10.85	07.92					
	1.3			08.83	07.84		G2112106		239 12,0 10,0 +S +C	
	1.6			08.83	07.92					
	1.8			08.83	07.92					
	1.8 16V			10.85	07.92					
	1.8 16V			10.85	07.92		G1020201		20961 15,2 /WD/Acc/S	LUC
	1.8 16V			10.85	07.92		G2110111	without sensor ring <sup>6)</sup>	226 10,0 8,0 +C	

### Classic PKW VOLVO 740 Estate (85-92)

















	2.0	76		09.88	08.90	+ multi link axle <sup>7)</sup>	G1020955		21385 13,0 /S	LUC
	2.0	82		08.89	08.90	+ multi link axle <sup>7)</sup>				
	2.0	86		09.87	08.88	+ multi link axle <sup>7)</sup>				
	2.0	89		09.87	08.90	+ multi link axle <sup>7)</sup>				
	2.3	83		09.87	12.89	+ multi link axle <sup>7)</sup>				
	2.3	84		09.87	07.90	+ multi link axle <sup>7)</sup>				
	2.3	85		09.87	08.90	+ multi link axle <sup>7)</sup>				
	2.3	96		09.87	07.88	+ multi link axle <sup>7)</sup>				
	2.3	100		08.89	07.90	+ multi link axle <sup>7)</sup>				
	2.3	111		07.89	08.90	+ multi link axle <sup>7)</sup>				
	↓									

<sup>1)</sup> + scatola cambio velocità / + transmission mécanique / + cambio de velocidad / + Schaltgetriebe  
<sup>2)</sup> + scatola cambio automatico / + transmission automatique / + cambio automático / + Automatikgetriebe  
<sup>3)</sup> + pinze flottante / + étriers flottant / + pinzas flotante / + Schwimmsattel  
<sup>4)</sup> + pinza freno flottante / + étriers à griffe / + pinza de puno / + Faustsattel  
<sup>5)</sup> +  $\text{\textcircled{J}}$  / + pinza flottante / +  $\text{\textcircled{J}}$  / + étriers à griffe / +  $\text{\textcircled{J}}$  / + pinza de puno / +  $\text{\textcircled{J}}$  / + Faustsattel  
<sup>6)</sup> senza sensori / sans secours ABS / sin anillo sensor ABS / ohne Sensorring  
<sup>7)</sup> + assale Multi-link / + essieu multi-link / + eje Multi-Link / + Multi-Link-Achse















































DACIA DUSTER (HS_) (10-)											
	1.6 16V 4x4	77		06.10				G1020741		23973 17,1 /Acc/S	LUC
	1.6 16V Flexifuel	77		04.11							
	1.6 16V LPG	77		04.11							
	1.5 dCi	63		04.10		+ ABS		G1201126		24538 17,9 +	ATE
	1.5 dCi	66		10.10		+ ABS					
	1.5 dCi	79		06.10		+ ABS					
	1.5 dCi 4x4	66		10.10							
1.5 dCi 4x4	79		06.10								
1.5 dCi 4x4	81		10.10								
	1.5 dCi	63		04.10		+ ABS		G2124221		280 24,0 21,8 V L +S +C	
	1.5 dCi	66		10.10		+ ABS					
	1.5 dCi	79		06.10		+ ABS					
	1.5 dCi 4x4	66		10.10							
	1.5 dCi 4x4	79		06.10							
	1.5 dCi 4x4	81		10.10							
	1.6 16V	77		04.10		+ ESP					
	1.6 16V 4x4	77		06.10		+ ESP					
	1.6 16V Flexifuel	77		04.11		+ ESP					
1.6 16V LPG	77		04.11		+ ESP						
DACIA LODGY (JS_) (12-)											
	1.5 dCi	66		03.12		- ESP		G1020741		23973 17,1 /Acc/S	LUC
	1.6	61		03.12		- ESP					
	1.2 TCe	85		03.12		+ ESP		G1201126		24538 17,9 +	ATE
	1.5 dCi	66		03.12		+ ESP					
	1.5 dCi	79		03.12		+ ESP					
1.6	61		03.12		+ ESP						
	1.2 TCe	85		03.12		+ ESP		G2122270		258 22,0 19,8 V L +S +C	
	1.5 dCi	66		03.12		+ ESP					
	1.5 dCi	79		03.12		+ ESP					
	1.6	61		03.12		+ ESP					
DACIA LOGAN Express (FS_) (09-)											
	1.4	55		03.09				G1020741		23973 17,1 /Acc/S	LUC
	1.5 dCi	50		03.09							
	1.5 dCi	55		05.10							
	1.5 dCi	63		03.09							
	1.5 dCi	65		05.10							
	1.6	64		03.09							
	1.6 Bifuel	62		05.10							
1.6 MPI 85	62		05.10								
	1.4	55		03.09				G2122216		260 22,0 19,8 V L +S +C	
	1.5 dCi	50		03.09							
	1.5 dCi	55		05.10							
	1.5 dCi	63		03.09							
	1.5 dCi	65		05.10							
	1.6	64		03.09							
	1.6 Bifuel	62		05.10							
1.6 MPI 85	62		05.10								
DACIA LOGAN Saloon (LS_) (04-13)											
	1.2 16V	55		02.06	04.13			G1020501		21463 18,2 /W/S	LUC
	1.4	55		09.04	04.13						
	1.4 MPI LPG	55		02.06	04.13						
	1.5 dCi	48		09.05	04.13						
	1.5 dCi	50		01.06	04.13						
	1.5 dCi	55		05.10	04.13						
	1.5 dCi	63		09.07	04.13						
	1.5 dCi	65		05.10	04.13						
	1.6 16V	64		09.04	04.13						
	1.6 16V	77		02.06	04.13						
	1.6 16V Flexifuel	77		01.11	04.13						
	1.6 Bifuel	62		05.10	04.13						
	1.6 MPI 85	62		05.10	04.13						
	1.2 16V	55		02.06	04.13	- ABS		G2112116		238 12,0 10,5 +S +C	
	1.4	55		09.04	04.13	- ABS					
	1.4 MPI LPG	55		02.06	04.13	- ABS					
	1.5 dCi	48		09.05	04.13	- ABS					
	1.5 dCi	50		01.06	04.13	- ABS					
	1.5 dCi	55		05.10	04.13	- ABS					
	1.5 dCi	63		09.07	04.13	- ABS					
	1.5 dCi	65		05.10	04.13	- ABS					
	1.6 16V	64		09.04	04.13	- ABS					
	1.6 16V	77		02.06	04.13	- ABS					
	1.6 16V Flexifuel	77		01.11	04.13	- ABS					
	1.6 Bifuel	62		05.10	04.13	- ABS					
	1.6 MPI 85	62		05.10	04.13	- ABS					
1.2 16V	55		02.06	04.13	+ ABS		G2112171		259 12,0 10,6 +S +C		
1.4	55		09.04	04.13	+ ABS						
1.4 MPI LPG	55		02.06	04.13	+ ABS						
1.5 dCi	48		09.05	04.13	+ ABS						
1.5 dCi	50		01.06	04.13	+ ABS						
1.5 dCi	55		05.10	04.13	+ ABS						
1.5 dCi	63		09.07	04.13	+ ABS						
1.5 dCi	65		05.10	04.13	+ ABS						
1.6 16V	64		09.04	04.13	+ ABS						

										
<b>DACIA LOGAN Saloon (LS_) (04-13)</b>										
	1.6 16V	77		02.06	04.13	+ ABS	G2112171	259 12,0 10,6 +S +C		
	1.6 16V Flexifuel	77		01.11	04.13	+ ABS				
	1.6 Bifuel	62		05.10	04.13	+ ABS				
	1.6 MPI 85	62		05.10	04.13	+ ABS				
	1.2 16V	55		02.06	04.13		G2121106	259 20,6 17,7 V +S +C		
	1.4	55		09.04	04.13					
	1.4 MPI LPG	55		02.06	04.13					
	1.5 dCi	48		09.05	04.13					
	1.5 dCi	50		01.06	04.13					
	1.5 dCi	55		05.10	04.13					
	1.5 dCi	63		09.07	04.13					
	1.5 dCi	65		05.10	04.13					
	1.6 16V	64		09.04	04.13					
1.6 16V	77		02.06	04.13						
1.6 16V Flexifuel	77		01.11	04.13						
1.6 Bifuel	62		05.10	04.13						
1.6 MPI 85	62		05.10	04.13						
<b>DACIA LOGAN MCV Estate (KS_) (07-13)</b>										
	1.4	55		02.07	03.08		G1020501	- ABS	21463 18,2 /W/S	LUC
	1.5 dCi	50		02.07	04.13					
	1.5 dCi	55		05.10	04.13					
	1.5 dCi	63		09.07	04.13					
	1.5 dCi	65		05.10	04.13					
	1.6	64		02.07	03.08					
	1.4	55		04.08	04.13		G1020741	+ ABS	23973 17,1 /Acc/S	LUC
	1.5 dCi	50		12.08	04.13					
	1.5 dCi	55		05.10	04.13					
	1.5 dCi	63		12.08	04.13					
1.5 dCi	65		05.10	04.13						
1.6	64		04.08	04.13						
1.6 16V	77		12.08	04.13						
1.6 16V Flexifuel	77		11.09	04.13						
	1.5 dCi	50		02.07	04.13	- ABS	G2121106	259 20,6 17,7 V +S +C		
	1.5 dCi	55		05.10	04.13	- ABS				
	1.5 dCi	63		09.07	04.13	- ABS				
	1.5 dCi	65		05.10	04.13	- ABS				
	1.4	55		02.07	04.13		G2122216	260 22,0 19,8 V L +S +C		
	1.5 dCi	50		02.07	04.13	+ ABS				
	1.5 dCi	55		05.10	04.13	+ ABS				
	1.5 dCi	63		09.07	04.13	+ ABS				
	1.5 dCi	65		05.10	04.13	+ ABS				
	1.6	64		02.07	04.13					
	1.6 16V	77		02.07	04.13					
	1.6 16V Flexifuel	77		11.09	04.13					
	1.6 Bifuel	64		11.08	04.13					
1.6 MPI 85	62		05.10	04.13						
<b>DACIA LOGAN Pick-up (US_) (08-)</b>										
	1.4	55		01.09			G1020741	23973 17,1 /Acc/S	LUC	
	1.5 dCi	50		12.08						
	1.5 dCi	55		05.10						
	1.5 dCi	63		12.08						
	1.5 dCi	65		05.10						
	1.6	64		12.08						
	1.6 Bifuel	62		05.10						
	1.6 MPI 85	62		05.10						
	1.4	55		01.09			G2122216	260 22,0 19,8 V L +S +C		
	1.5 dCi	50		03.08						
	1.5 dCi	55		05.10						
	1.5 dCi	63		03.08						
	1.5 dCi	65		05.10						
	1.6	64		03.08						
	1.6 Bifuel	62		05.10						
	1.6 MPI 85	62		05.10						
<b>DACIA LOGAN II Saloon (L52_) (12-)</b>										
	1.2 16V 75	55		11.12			G2112171	259 12,0 10,6 +S +C		
	1.2 16V LPG	55		11.12						
<b>DACIA SANDERO (08-13)</b>										
	1.2 16V	55		11.08	02.13		G1020501	21463 18,2 /W/S	LUC	
	1.2 16V Bifuel	55		11.08	02.13					
	1.4	55		06.08	02.13					
	1.4 MPI LPG	53		01.09	02.13					
	1.5 dCi	50		11.08	02.13					
	1.5 dCi	55		05.10	02.13					
	1.5 dCi	65		05.10	02.13					
	1.6	64		06.08	02.13					
	1.6 16V	77		01.11	02.13					
	1.6 MPI 85	62		05.10	02.13					
	1.2 16V	55		11.08	02.13		G2112171	259 12,0 10,6 +S +C		
	1.2 16V Bifuel	55		11.08	02.13					
	1.4	55		06.08	02.13					
	1.4 MPI LPG	53		01.09	02.13					



								
<b>DACIA SANDERO (08-13)</b>								
	1.5 dCi	50		11.08	02.13	G2112171		259 12,0 10,6 +S +C
	1.5 dCi	55		05.10	02.13			
	1.5 dCi	65		05.10	02.13			
	1.6	64		06.08	02.13			
	1.6 16V	77		01.11	02.13			
	1.6 MPI 85	62		05.10	02.13			
	1.5 dCi	63		11.08	02.13	G2122216		260 22,0 19,8 V L +S +C
	1.2 16V	55		02.09	02.13	G2121106		259 20,6 17,7 V +S +C
	1.2 16V Bifuel	55		11.08	02.13			
	1.5 dCi	55		05.10	02.13			
	1.5 dCi	65		05.10	02.13			
	1.6 16V	77		01.11	02.13			
1.6 MPI 85	62		05.10	02.13				
<b>DACIA SANDERO II (B52_) (12-)</b>								
	1.2 16V	55		11.12		G2112171		259 12,0 10,6 +S +C
	1.2 16V LPG	53		11.12				
<b>DAEWOO ARANOS (95-97)</b>								
	1.5	66		01.95	11.97	G1020258		21190 17,5 +WD ATE
	1.8	70		01.95	11.97			
	2.0	77		01.95	11.97			
	1.5	66		01.95	11.97	G2124115		256 24,0 21,0 V L +S +C
	1.8	70		01.95	11.97			
	2.0	77		01.95	11.97			
<b>DAEWOO CIELO (94-98)</b>								
	1.5	66		06.94	07.98	G1020258		21190 17,5 +WD ATE
	1.5	66		06.94	07.98			
	1.5	66		06.94	07.98	G2124115		256 24,0 21,0 V L +S +C
	1.5	66		06.94	07.98			
<b>DAEWOO ESPERO (95-99)</b>								
	1.5 i 16V			02.95	06.99	G1020258		21190 17,5 +WD ATE
	1.8 i			02.95	06.99			
	2.0 i			02.95	06.99			
	1.5 i 16V			02.95	06.99	G2124115		256 24,0 21,0 V L +S +C
	1.8 i			02.95	06.99			
	2.0 i			02.95	06.99			
<b>DAEWOO KALOS (02-05)</b>								
	1.2 i	53		04.03	02.05	G2120115		236 20,0 17,0 V L +S +C
	1.4 i	61		09.02	02.05			
	1.4 i 16V	69		04.03	02.05			
	1.6 i 16V	78		11.02	02.05			
<b>DAEWOO LANOS (97-02)</b>								
	1.4 i	55	447433	05.97		G1020317		20547 16,5 +WD ATE
	1.5 i	63	447433	05.97				
	1.6 i 16V	78	447433	05.97				
	1.4 i	55		05.97	12.02	G2120115		236 20,0 17,0 V L +S +C
	1.5 i	63		05.97	12.02			
	1.6 i 16V	78		05.97	12.02			
<b>DAEWOO MATIZ (98-05)</b>								
	0.8 (KLA4)	38		07.98	02.05	G2113195		236 12,6 9,7 +C
	1.0 (KLA0)	47		01.03	02.05			
<b>DAEWOO NEXIA (95-97)</b>								
	1.5 i			02.95	08.97	G1020317		20547 16,5 +WD ATE
	1.5 i 16V	66		02.95	08.97			
	1.8 i	74		10.95	08.97			
	1.5 i			02.95	08.97	G2120115		236 20,0 17,0 V L +S +C
	1.5 i 16V	66		02.95	08.97			
	1.8 i	74		10.95	08.97			
<b>DAIHATSU CHARADE (11-)</b>								
	1.33 16V	73		05.11		G1020798		24022 17,8 +WI ATE
	1.33 16V	73		05.11				
	1.33 16V	73		05.11		G2122240		258 22,0 20,0 V +C
	1.33 16V	73		05.11				
	1.33 16V	73		05.11		G1020666		24574 15,0 +WI ATE
	1.33 16V	73		05.11				
	1.33 16V	73		05.11		G2109142		278 9,0 7,0 +C
	1.33 16V	73		05.11				

DAIHATSU MATERIA (06-12)											
	1.3 DVVT 1.5 DVVT 1.5 DVVT 4WD	67 76 76		10.06 10.06 10.06	07.12 07.12 07.12			G1201053			24283 15,5 +/WI/Acc/S
DAIHATSU SIRION (05-13)											
	1.0 DVVT 1.0 DVVT 4WD 1.3 DVVT 1.3 DVVT 1.3 DVVT 4WD 1.3 DVVT 4WD 1.5 DVVT 1.5 DVVT 4WD	51 51 64 67 64 67 76 76		07.07 07.07 07.07 03.08 04.05 03.08 03.08 05.06	01.13 01.13 01.13 01.13 01.13 01.13 01.13 10.08			G1201053			24283 15,5 +/WI/Acc/S
+ 14" wheel <sup>1)</sup>											
+ 14" wheel <sup>1)</sup>											
FIAT 500 (07-)											
	1.2 i 1.2 i Start-Stop 1.2 LPG 1.3 D Multijet 1.3 D Multijet 1.4 i 16V 1.4 Abarth 1.4 Abarth 1.4 Abarth	51 51 51 55 70 74 99 103 118		07.07 11.08 12.10 07.07 12.09 07.07 07.08 05.10 08.08	04.13 04.13 04.13			G1020951 G1020952 G1020740 G1020737 G1020738 G1201225			21436 17,0 /WI/Acc BOS 24072 17,9 +/WI/Acc/S BOS 23706 18,0 +/WI/S BOS 23706 18,0 +/WI/Acc/S BOS 23709 19,0 +/WI/Acc/S BOS 23709 19,0 +/WI/Acc/S BOS
for vehicle with 1 WI <sup>2)</sup>											
for vehicles + 2 warn.contacts <sup>3)</sup>											
	0.9 0.9 1.3 D Multijet 1.3 D Multijet 1.4 i 16V 1.4 Abarth 1.4 Abarth 1.4 Abarth	48 63 55 70 74 99 103 118		09.12 07.10 07.07 12.09 07.07 07.08 05.10 08.08			G2112127 G2120184 G2122197 G2122147				258 12,0 10,2 +C 241 20,0 18,2 V +C 258 22,0 20,2 V +C 284 22,0 20,2 V +C
- Kit ESSEESSE											
	1.4 Abarth 1.4 Abarth 1.4 Abarth 1.4 Abarth Assetto C. 1.4 Abarth Tributo F. 1.4 i 16V	99 103 118 140 132 74		07.08 05.10 08.08 08.08 08.08 07.07			G1020567				23601 13,7 /S LUC
FIAT 500C Convertible (09-)											
	1.2 1.3 D Multijet 1.3 D Multijet 1.4 1.4 Abarth 1.4 Abarth	51 55 70 74 118		09.09 09.09 09.09 09.09 09.09 05.11			G1020952 G1020740 G1020737 G1020738 G1201225				24072 17,9 +/WI/Acc/S BOS 23706 18,0 +/WI/S BOS 23706 18,0 +/WI/Acc/S BOS 23709 19,0 +/WI/Acc/S BOS 23709 19,0 +/WI/Acc/S BOS
for vehicle with 1 WI <sup>2)</sup>											
for vehicles + 2 warn.contacts <sup>3)</sup>											
	0.9 1.2 1.3 D Multijet 1.3 D Multijet 1.4 1.4 Abarth 1.4 Abarth	63 51 55 70 74 118		09.09 09.09 09.09 09.09 09.09 05.11			G2112127 G2120184 G2122197 G2122147				258 12,0 10,2 +C 241 20,0 18,2 V +C 258 22,0 20,2 V +C 284 22,0 20,2 V +C
- Kit ESSEESSE											
	1.4 1.4 Abarth 1.4 Abarth	74 118		09.09 09.09 05.11			G1020567				23601 13,7 /S LUC
FIAT ALBEA (02-)											
	1.2 i 1.2 i 16V 1.3 JTD 1.4 i 1.6 i 16V	44 59 51 57 76		03.02 03.02 03.02 03.02 03.02			G1020740				23706 18,0 +/WI/S BOS
FIAT BARCHETTA (95-04)											
	1.8 i 16V 1.8 i 16V			04.95 06.95	05.95 10.04			G1020140 G1020342			20839 17,0 /WI/S LUC 21927 17,9 +/WI ATE
	1.8 i 16V			04.95	10.04			G2120142			258 20,0 18,2 V L +C
	1.8 i 16V			04.95	10.04			G1020236 G1020384			21103 14,2 /S LUC 23177 14,2 /S LUC
+ cast iron caliper <sup>4)</sup>											
+ aluminium calipers <sup>5)</sup>											
FIAT BRAVA (95-01)											
	1.2 i 16V 1.4 i 12V 1.6 16 V 1.6 i 16V 1.9 D 1.9 TD 1.8 i 16V			12.98 09.95 01.99 09.95 09.95 06.96 09.95	10.01 10.01 12.02 10.01 10.01 10.01 10.01			G1020340			21930 17,9 +/WI ATE
+ manual transmission <sup>6)</sup>											
+ manual transmission <sup>6)</sup>											
+ manual transmission <sup>6)</sup>											
+ manual transmission <sup>6)</sup>											
+ manual transmission <sup>6)</sup>											
+ manual transmission <sup>6)</sup>											
	1.8 i 16V			09.95	10.01			G1020342			21927 17,9 +/WI ATE

<sup>1)</sup> + ruota 14" / + roue 14" / + rueda 14" / + 14" Rad

<sup>2)</sup> per autovettura con 1 RU / pour véhicule avec 1 TU / para vehículo con 1 CD / für Fzg. mit 1 WK

<sup>3)</sup> per veicoli + 2 contatti d'allarme / pour véhic.+ 2 contacts d'alerte / para vehic.+ 2 contact.alarma / für Fzg. mit 2 WK

<sup>4)</sup> + pinza in ghisa / + étriers en fonte grise / + fundición gris-pinza / + GG-Sättel

<sup>5)</sup> + pinze in alluminio / + étriers en aluminium / + pinzas de aluminio / + ALU-Sättel

<sup>6)</sup> + scatola cambio velocità / + transmission mécanique / + cambio de velocidad / + Schaltgetriebe



FIAT BRAVA (95-01)										
	1.9 JTD			12.98	10.01		G1020342		21927 17,9 +/Wl	ATE
	1.9 TD	74		06.96	10.01					
	2.0	113		09.98	08.00					
	1.2 i 16V			12.98	10.01	+ autom.transmission 1)	G1020342		21927 17,9 +/Wl	ATE
	1.4 i 12V			09.95	10.01	+ autom.transmission 1)				
	1.6 16 V	76		01.99	12.02	+ autom.transmission 1)				
	1.6 i 16V			09.95	10.01	+ autom.transmission 1)				
1.9 D			09.95	10.01	+ autom.transmission 1)					
1.9 TD	55		06.96	10.01	+ autom.transmission 1)					
	1.2 i 16V			12.98	10.01	+ manual transmission 2)	G2112127		258 12,0 10,2 +C	
	1.4 i 12V			09.95	10.01	+ manual transmission 2)				
	1.6 16 V	76		01.99	12.02	+ manual transmission 2)				
	1.6 i 16V			09.95	10.01	+ manual transmission 2)				
	1.9 D			09.95	10.01	+ manual transmission 2)				
	1.9 TD	55		06.96	10.01	+ manual transmission 2)				
	1.2 i 16V			12.98	10.01	+ autom.transmission 1)	G2120142		258 20,0 18,2 V L +C	
1.4 i 12V			09.95	10.01	+ autom.transmission 1)					
1.6 16 V	76		01.99	12.02	+ autom.transmission 1)					
1.6 i 16V			09.95	10.01	+ autom.transmission 1)					
1.8 i 16V			09.95	10.01						
1.9 D			09.95	10.01	+ autom.transmission 1)					
1.9 JTD			12.98	10.01						
1.9 TD	55		06.96	10.01	+ autom.transmission 1)					
1.9 TD	74		06.96	10.01						
2.0	113		09.98	08.00						

FIAT BRAVO (95-01)										
	1.2 i 16V			12.98	10.01		G1020340		21930 17,9 +/Wl	ATE
	1.4 i 12V			09.95	10.01					
	1.6 i 16V			09.95	10.01					
	1.9 D			09.95	10.01					
	1.9 TD	55		06.96	10.01					
	1.8 i 16V			09.95	10.01		G1020342		21927 17,9 +/Wl	ATE
	1.9 JTD			12.98	10.01					
	1.9 TD	74		06.96	10.01					
	2.0 i 20V			09.95	04.99		G1020360		21636 19,3 +/Wl	ATE
	2.0 i 20V			05.99	10.01		G1020473		23289 19,3 +/Wl	ATE
	1.2 i 16V			12.98	10.01		G2112127		258 12,0 10,2 +C	
	1.4 i 12V			09.95	10.01					
	1.6 i 16V			09.95	10.01					
	1.9 D			09.95	10.01					
	1.9 TD	55		06.96	10.01					
	1.8 i 16V			09.95	10.01		G2120142		258 20,0 18,2 V L +C	
	1.9 JTD			12.98	10.01					
	1.9 TD	74		06.96	10.01					
	2.0 i 20V			09.95	10.01		G2122147		284 22,0 20,2 V +C	
	2.0 i 20V			09.95	10.01		G1020236 G1020384	+ cast iron caliper 3) + aluminium calipers 4)	21103 14,2 /S 23177 14,2 /S	LUC LUC

FIAT BRAVO (07-)										
	1.4 i 16V	66		04.07			G1020740		23706 18,0 +/Wl/S	BOS
	1.4 LPG	66		11.09						
	1.4 16V	103		04.08			G1020503		23708 19,0 +/Wl/S	BOS
	1.4 T-Jet	88		09.07						
	1.6 D Multijet			03.08						
	1.9 D Multijet			04.07						
	1.9 D Multijet	66		04.07	12.08					
	1.4 T-Jet	110		09.07			G1020504		23711 19,4 +/Wl/S	BOS
	1.9 D Multijet	110		04.07						
	2.0 D Multijet			09.08						
	1.4 i 16V	66		04.07			G2122197		258 22,0 20,2 V +C	
	1.4 LPG	66		11.09						
	1.4 16V	103		04.08			G2122147		284 22,0 20,2 V +C	
	1.4 T-Jet	88		09.07						
1.6 D Multijet			03.08							
1.9 D Multijet			04.07							
1.9 D Multijet	66		04.07	12.08						
	1.4 16V	103		04.08			G1020515 G1201128		23714 16,6 /S 23714 17,6 +/Wl/Acc/S	BOS BOS
	1.4 i 16V	66		04.07						
	1.4 LPG	66		11.09						
	1.4 T-Jet	88		09.07						
	1.4 T-Jet	110		09.07						
	1.6 D Multijet			03.08						
	1.9 D Multijet			04.07						
	1.9 D Multijet	66		04.07	12.08					
	1.9 D Multijet	110		04.07						
	2.0 D Multijet			09.08						
	1.4 16V	103		04.08			G2110190		252 10,0 9,0 +C	
	1.4 16V	103		04.08						
	1.4 i 16V	66		04.07						
	1.4 T-Jet	88		09.07						
	1.6 D Multijet	110		09.07						

1) + scatola cambio automatico / + transmission automatique / + cambio automático / + Automatikgetriebe

2) + scatola cambio velocità / + transmission mécanique / + cambio de velocidad / + Schaltgetriebe

3) + pinza in ghisa / + étriers en fonte grise / + fundición gris-pinza / + GG-Sättel

4) + pinze in alluminio / + étriers en aluminium / + pinzas de aluminio / + ALU-Sättel

FIAT BRAVO (07-)							
	1.9 D Multijet 1.9 D Multijet 1.9 D Multijet 2.0 D Multijet	66 110	04.07 04.07 04.07 09.08	12.08	G2110190		252 10,0 9,0 +C
FIAT CINQUECENTO (92-98)							
	1100 Sporting 700 900 i.e.		11.94 02.92 02.92	05.98 05.98 05.98	G1020259		21365 17,0 BDX
FIAT COUPE (94-00)							
	1.8 i 16V 2.0 i 20V		07.96 01.97	12.00 12.00	G1020360		21636 19,3 +/-WI ATE
	2.0 i 16V 2.0 i 16V Turbo		12.93 12.93	06.96 06.96	G1020360		21636 19,3 +/-WI ATE
	2.0 i 16V Turbo		12.93	06.96	G2122147		284 22,0 20,2 V +C
	1.8 i 16V 2.0 i 16V 2.0 i 16V Turbo 2.0 i 20V 2.0 i 20V Turbo	47167  47167 47167	07.96 12.93 12.93 01.97 01.97	06.96 06.96 06.96	G1020236	+ cast iron caliper <sup>1)</sup>	21103 14,2 /S LUC
	1.8 i 16V 2.0 i 20V 2.0 i 20V Turbo	47168 47168 47168		12.00 12.00 12.00	G1020384	+ aluminium calipers <sup>2)</sup>	23177 14,2 /S LUC
FIAT CROMA (91-96)							
	2.0 i.e. 2.0 i.e. Turbo		11.90 11.90	10.96 10.96	G2122145	+ armoured vehicles <sup>3)</sup> + armoured vehicles <sup>3)</sup>	284 22,0 20,2 V +C
	2.5 i.e. V6		04.93	10.96	G2122147		284 22,0 20,2 V +C
	1.6 1.9 TD 2.0 2.0 i.e. 2.0 i.e. 16V 2.0 i.e. Turbo 2.5 D 2.5 i.e. V6 2.5 TD		11.90 11.90 11.90 11.90 12.92 11.90 11.90 11.90 11.90	12.92 10.96 12.92 10.96 10.96 10.96 10.96 10.96	G2110190	- armoured vehicles <sup>4)</sup> - armoured vehicles <sup>4)</sup> - armoured vehicles <sup>4)</sup>	252 10,0 9,0 +C
	2.0 i.e. 2.0 i.e. Turbo		11.90 11.90	10.96 10.96	G2110209	+ armoured vehicles <sup>3)</sup> + armoured vehicles <sup>3)</sup>	251 10,0 9,0 +C
FIAT CROMA (05-10)							
	1.8 i 16V 1.9 D Multijet 1.9 JTD 1.9 JTD 16V 2.2 i 16V	103 85 88 2060169 108	01.06 06.05 06.05 06.05 06.05	11.10 11.10 11.10 11.10 11.10	G1020836 G1020650	for br.caliper +steel piston <sup>5)</sup> for br.caliper +plastic piston <sup>6)</sup>	23738 20,1 +/-WD ATE 23402 20,1 +/-WD ATE
	1.8 i 16V 1.9 D Multijet 1.9 JTD 1.9 JTD 16V 2.2 i 16V	103 85 88 2060169 108	01.06 06.05 06.05 06.05 06.05	11.10 11.10 11.10 11.10 11.10	G2125141		285 24,9 22,0 V L +S +C
	1.8 i 16V 1.9 D Multijet 1.9 JTD 1.9 JTD 16V 2.2 i 16V 2.4 JTD	103 85 88 2060169 108 147	01.06 06.05 06.05 06.05 06.05 06.05	11.10 11.10 11.10 11.10 11.10 11.10	G1020672		24348 17,1 /S LUC
	1.8 i 16V 1.9 D Multijet 1.9 JTD 2.2 i 16V	103 85 88 108	01.06 06.05 06.05 06.05	11.10 11.10 11.10 11.10	G2112157		278 11,9 10,0 +S +C
FIAT DOBLO (01-10)							
	1.2 i.e. 1.3 JTD 1.6 i 16V 1.6 Natural Power 1.9 D 1.9 JTD 1.9 JTD	48 51 76 76 46 74 77	01.01 05.04 10.01 09.02 01.01 10.01 07.03	09.05 09.05 09.05 09.05 09.05 09.05 09.05	G1020496		23842 18,1 + ATE
	1.3 16V 1.3 D Multijet 1.3 D Multijet 1.3 JTD 1.3 JTD 1.4 i 1.6 16V 1.6 i 16V 1.6 Natural Power 1.9 D Multijet 1.9 JTD 1.9 JTD 1.9 JTD	66 55 62 55 62 57 77 76 76 88 74 77 88	12.09 10.05 10.05 10.05 10.05 10.05 12.09 10.05 10.05 10.05 10.05 10.05 10.05	01.10 01.10 01.10 01.10 01.10 01.10 01.10 01.10 01.10 01.10 01.10 01.10 01.10	G1020614	+ brake disc diameter 284mm <sup>7)</sup> + brake disc diameter 284mm <sup>7)</sup> + brake disc diameter 284mm <sup>7)</sup> + brake disc diameter 284mm <sup>7)</sup> + brake disc diameter 284mm <sup>7)</sup> + brake disc diameter 284mm <sup>7)</sup> + brake disc diameter 284mm <sup>7)</sup> + brake disc diameter 284mm <sup>7)</sup> + brake disc diameter 284mm <sup>7)</sup> + brake disc diameter 284mm <sup>7)</sup> + brake disc diameter 284mm <sup>7)</sup> + brake disc diameter 284mm <sup>7)</sup> + brake disc diameter 284mm <sup>7)</sup>	23708 19,0 /S BOS

<sup>1)</sup> + pinza in ghisa / + étriers en fonte grise / + fundición gris-pinza / + GG-Sättel

<sup>2)</sup> + pinze in alluminio / + étriers en aluminium / + pinzas de aluminio / + ALU-Sättel

<sup>3)</sup> + veicoli blindati / + véhicule blindé / + vehículo blindado / + gepanzerte Fahrzeuge

<sup>4)</sup> - veicoli blindati / - véhicule blindé / - vehículo blindado / - gepanzerte Fahrzeuge

<sup>5)</sup> per pinza fr. + pistone acciaio / pour étrier f. + piston en acier / para pinza fr. + pistón de acero / f. Bremssattel m. Stahlkolben

<sup>6)</sup> per pinza fr. + pistone plastica / pour étrier fr. + piston plastique / para pinza fr. + pistón plástico / f. Bremssattel m. Kunststoffkolben

<sup>7)</sup> + diametro dischi freno 284mm / + diamètre disques frein 284mm / + diametro disco freno 284mm / + Bremsscheibendurchm. 284 mm



















FIAT DOBLO (01-10)									
	2.0 16V	99		12.09	01.10	+ brake disc diameter 284mm <sup>1)</sup>	G1020614	23708 19,0 /S	BOS
	1.3 16V	66		12.09	01.10	+ brake disc diameter 258mm <sup>2)</sup>	G1020987	23707 18,0 /Acc/S	BOS
	1.3 D Multijet	55		10.05	01.10	+ brake disc diameter 258mm <sup>2)</sup>			
	1.3 D Multijet	62		10.05	01.10	+ brake disc diameter 258mm <sup>2)</sup>			
	1.3 JTD	55		10.05	01.10	+ brake disc diameter 258mm <sup>2)</sup>			
	1.3 JTD	62		10.05	01.10	+ brake disc diameter 258mm <sup>2)</sup>			
	1.4 i	57		10.05	01.10	+ brake disc diameter 258mm <sup>2)</sup>			
	1.6 16V	77		12.09	01.10	+ brake disc diameter 258mm <sup>2)</sup>			
	1.6 i 16V	76		10.05	01.10	+ brake disc diameter 258mm <sup>2)</sup>			
	1.6 Natural Power	76		10.05	01.10	+ brake disc diameter 258mm <sup>2)</sup>			
	1.9 D Multijet	88		10.05	01.10	+ brake disc diameter 258mm <sup>2)</sup>			
	1.9 JTD	74		10.05	01.10	+ brake disc diameter 258mm <sup>2)</sup>			
	1.9 JTD	77		10.05	01.10	+ brake disc diameter 258mm <sup>2)</sup>			
	1.9 JTD	88		10.05	01.10	+ brake disc diameter 258mm <sup>2)</sup>			
	2.0 16V	99		12.09	01.10	+ brake disc diameter 258mm <sup>2)</sup>			
	1.2 i.e.	48		01.01	09.05		G2120142	258 20,0 18,2 V L +C	
	1.3 JTD	51		05.04	09.05				
	1.6 i 16V	76		10.01	09.05				
	1.6 Natural Power	76		09.02	09.05				
	1.9 D	46		01.01	09.05				
	1.9 JTD	74		10.01	09.05				
	1.9 JTD	77		07.03	09.05				
	1.3 16V	66		12.09	01.10		G2122147	284 22,0 20,2 V +C	
	1.3 D Multijet	55		10.05	01.10				
	1.3 D Multijet	62		10.05	01.10				
	1.3 JTD	55		10.05	01.10				
	1.3 JTD	62		10.05	01.10				
	1.4 i	57		10.05	01.10				
	1.6 16V	77		12.09	01.10				
	1.6 i 16V	76		10.05	01.10				
	1.6 Natural Power	76		09.02	01.10				
	1.9 JTD	74		10.05	01.10				
	1.9 JTD	77		10.05	01.10				
	1.9 JTD	88		10.05	01.10				
	1.9 JTD	88		10.05	01.10				
	2.0 16V	99		12.09	01.10				
	1.3 16V	66		12.09	01.10		G2122197	258 22,0 20,2 V +C	
	1.3 D Multijet	55		10.05	01.10				
	1.3 D Multijet	62		10.05	01.10				
	1.3 JTD	55		10.05	01.10				
	1.3 JTD	62		10.05	01.10				
	1.4 i	57		10.05	01.10				
	1.6 16V	77		12.09	01.10				
	1.6 i 16V	76		10.05	01.10				
	1.6 Natural Power	76		09.02	01.10				
	1.9 JTD	74		10.05	01.10				
	1.9 JTD	77		10.05	01.10				
	1.9 JTD	88		10.05	01.10				
	1.9 JTD	88		10.05	01.10				
	2.0 16V	99		12.09	01.10				

FIAT DOBLO (10-)									
	1.3 D Multijet	66		02.10			G1020738	23709 19,0 +/W/Acc/S	BOS
	1.4	70		02.10					
	1.4	88		10.11					
	1.4 Natural Power	88		02.10					
	1.6 D 16V Multijet	66		02.10					
	1.6 D 16V Multijet	77		02.10					
	1.6 D Multijet	74		02.10					
	1.6 D Multijet	77		02.10					
	2.0 D Multijet	99		02.10					
	1.3 D Multijet	66		02.10			G2122145	284 22,0 20,2 V +C	
	1.4	70		02.10					
	1.4	88		10.11					
	1.4 Natural Power	88		02.10					
	1.6 D 16V Multijet	66		02.10					
	1.6 D 16V Multijet	77		02.10					
	1.6 D Multijet	74		02.10					
	1.6 D Multijet	77		02.10					
	2.0 D Multijet	99		02.10					

FIAT DUCATO (94-02)									
	1.9 D (10)			02.94	12.99		G1020301	21797 19,7 +/W/S	LUC
	1.9 TD (10)			02.94	12.99				
	1.9 TD CAT (10)			02.94	12.99				
	2.0 i (10/14)			02.94	12.99				
	2.5 D (14)			02.94	12.99				
	2.5 TDI (14)			02.94	12.99				
	2.5 TDI ECO (14)			02.94	12.99				
	2.8 D (14)			02.98	12.99				
	2.8 TDI (14)			10.97	12.99				
	1.9 D (10)			01.00	10.01		G1020482	23602 19,7 +/W/S	LUC
	1.9 TD (10)			01.00	10.01				
	1.9 TD CAT (10)			01.00	10.01				
	2.0 i (10/14)			01.00	10.01				
	2.5 D (14)			01.00	10.01				

<sup>1)</sup> + diametro dischi freno 284mm / + diamètre disques frein 284mm / + diámetro disco freno 284mm / + Bremsscheibendurchm. 284 mm  
<sup>2)</sup> + diametro dischi freno 258mm / + diamètre disques frein 258mm / + diámetro disco freno 258mm / + Bremsscheibendurchm. 258 mm

												
FIAT DUCATO (94-02)												
	2.5 TDI (14)			01.00	10.01	G1020482	23602 19,7 +/W/S	LUC				
	2.5 TDI ECO (14)			01.00	10.01							
	2.8 D (14)			01.00	10.01							
	2.8 JTD (14)			11.00	10.01							
	2.8 TDI (14)			01.00	10.01							
	1.9 D (10)			11.01	03.02	G1020516	23917 19,3 +/W/Acc	BRE				
	1.9 TD (10)			11.01	03.02							
	1.9 TD CAT (10)			11.01	03.02							
	2.0 i (10/14)			11.01	03.02							
	2.0 JTD (14)			10.01	03.02							
	2.5 D (14)			11.01	03.02							
	2.5 TDI (14)			11.01	03.02							
2.5 TDI ECO (14)			11.01	03.02								
2.8 D (14)			11.01	03.02								
2.8 JTD (14)			11.01	03.02								
2.8 TDI (14)			11.01	03.02								
	2.0 i (18)			02.94	12.99	G1020302	21799 19,7 +/W/S	LUC				
	2.5 D (18)			02.94	12.99							
	2.5 TDI (18)			02.94	12.99							
	2.5 TDI ECO (18)			02.94	12.99							
	2.8 D (18)			02.98	12.99							
	2.8 TDI (18)			10.97	12.99							
	2.0 i (18)			01.00	10.01	G1020483	23603 19,7 +/W/S	LUC				
	2.5 D (18)			01.00	10.01							
	2.5 TDI (18)			01.00	10.01							
	2.5 TDI ECO (18)			01.00	10.01							
2.8 D (18)			01.00	10.01								
2.8 JTD (18)			11.00	10.01								
2.8 TDI (18)			01.00	10.01								
	2.0 i (18)			11.01	03.02	G1020517	23919 19,3 +/W/Acc	BRE				
	2.0 JTD (18)			10.01	03.02							
	2.5 D (18)			11.01	03.02							
	2.5 TDI (18)			11.01	03.02							
	2.5 TDI ECO (18)			11.01	03.02							
	2.8 D (18)			11.01	03.02							
	2.8 JTD (18)			11.01	03.02							
	2.8 TDI (18)			11.01	03.02							
		2.5 TDI (14)			02.94				10.01	G2124127	280 24,0 21,9 V +C	
		2.5 TDI ECO (14)			02.94				10.01			
2.8 JTD (14)				11.00	10.01							
2.8 TDI (14)				10.97	10.01							
2.0 i (18)				02.94	10.01	G2124138	300 24,0 21,9 V +C					
2.5 D (18)			02.94	10.01								
2.5 TDI (18)			02.94	10.01								
2.5 TDI ECO (18)			02.94	10.01								
2.8 D (18)			02.98	10.01								
2.8 JTD (18)			11.00	10.01								
2.8 TDI (18)			10.97	10.01								
	1.9 D (10)			11.01	03.02	G2124127	280 24,0 21,9 V +C					
	1.9 TD (10)			11.01	03.02							
	1.9 TD CAT (10)			11.01	03.02							
	2.0 i (10/14)			11.01	03.02							
	2.0 JTD (14)			10.01	03.02							
	2.5 D (14)			11.01	03.02							
	2.5 TDI (14)			11.01	03.02							
	2.5 TDI ECO (14)			11.01	03.02							
	2.8 D (14)			11.01	03.02							
	2.8 JTD (14)			11.01	03.02							
2.8 TDI (14)			11.01	03.02								
	2.0 i (18)			11.01	03.02	G2124138	300 24,0 21,9 V +C					
	2.0 JTD (18)			10.01	03.02							
	2.5 D (18)			11.01	03.02							
	2.5 TDI (18)			11.01	03.02							
	2.5 TDI ECO (18)			11.01	03.02							
	2.8 D (18)			11.01	03.02							
	2.8 JTD (18)			11.01	03.02							
	2.8 TDI (18)			11.01	03.02							
		1.9 D (10)			11.01				03.02	G1020518	23921 20,3 /Acc	BRE
		1.9 TD (10)			11.01				03.02			
1.9 TD CAT (10)				11.01	03.02							
2.0 i (10/14/18)				11.01	03.02							
2.0 JTD (14/18)				10.01	03.02							
2.5 D (14/18)				11.01	03.02							
2.5 TDI (14/18)				11.01	03.02							
2.5 TDI ECO (14/18)				11.01	03.02							
2.8 D (14/18)				11.01	03.02							
2.8 JTD (14/18)				11.01	03.02							
2.8 TDI (14/18)			11.01	03.02								
	1.9 D (10)			11.01	03.02	G2116124	280 16,0 14,2 +C					
	1.9 TD (10)			11.01	03.02							
	1.9 TD CAT (10)			11.01	03.02							
	2.0 i (10/14)			11.01	03.02							
	2.0 JTD (14)			10.01	03.02							
	2.5 D (14)			11.01	03.02							
	2.5 TDI (14)			11.01	03.02							
	2.5 TDI ECO (14)			11.01	03.02							

FIAT DUCATO (94-02)													
	2.8 D (14) 2.8 JTD (14) 2.8 TDI (14)			11.01 11.01 11.01	03.02 03.02 03.02			G2116124				280 16,0 14,2 +C	
FIAT DUCATO (02-06)													
	2.0 i (11/15) 2.0 JTD (11/15) 2.3 JTD (11/15) 2.8 JTD (11/15) 2.8 JTD 4x4 (11/15)	81 62 81 81 94		04.02 04.02 04.02 04.02 07.02	07.06 07.06 07.06 07.06 07.06			G1020516				23917 19,3 +/W/Acc	BRE
	2.0 i (18) 2.0 JTD (18) 2.3 JTD (18) 2.8 JTD (18) 2.8 JTD 4x4 (18)	81 62 81 81 94		04.02 04.02 04.02 04.02 07.02	07.06 07.06 07.06 07.06 07.06			G1020517				23919 19,3 +/W/Acc	BRE
	2.0 i (11/15) 2.0 JTD (11/15) 2.3 JTD (11/15) 2.8 JTD (11/15) 2.8 JTD 4x4 (11/15)	81 62 81 81 94		04.02 04.02 04.02 04.02 07.02	07.06 07.06 07.06 07.06 07.06			G2124127				280 24,0 21,9 V +C	
	2.0 i (18) 2.0 JTD (18) 2.3 JTD (18) 2.8 JTD (18) 2.8 JTD 4x4 (18)	81 62 81 81 94		04.02 04.02 04.02 04.02 07.02	07.06 07.06 07.06 07.06 07.06			G2124138				300 24,0 21,9 V +C	
	2.0 i (11/15/18) 2.0 JTD (11/15/18) 2.3 JTD (11/15/18) 2.8 JTD (11/15/18) 2.8 JTD 4x4(11/15/18)	81 62 81 81 94		04.02 04.02 04.02 04.02 07.02	07.06 07.06 07.06 07.06 07.06			G1020518				23921 20,3 /Acc	BRE
	2.0 i (11/15) 2.0 JTD (11/15) 2.3 JTD (11/15) 2.8 JTD (11/15) 2.8 JTD 4x4 (11/15)	81 62 81 81 94		04.02 04.02 04.02 04.02 07.02	07.06 07.06 07.06 07.06 07.06			G2116124				280 16,0 14,2 +C	
FIAT DUCATO (06-)													
	140 Natural Power 2.0 D 115 Multijet 2.2 D 100 Multijet 2.3 D 120 Multijet 2.3 D 130 Multijet 2.3 D 150 Multijet 3.0 D 150 Multijet 3.0 D 160 Multijet 3.0 D Multijet	100 85 74 88 96 109 107 116 130		04.09 06.11 07.06 07.06 01.07 06.11 04.10 07.06 06.11	payload 110/150 <sup>1)</sup> payload 110/150 <sup>1)</sup> payload 110/150 <sup>1)</sup> payload 110/150 <sup>1)</sup> payload 110/150 <sup>1)</sup> payload 110/150 <sup>1)</sup> payload 110/150 <sup>1)</sup> payload 110/150 <sup>1)</sup> payload 110/150 <sup>1)</sup>			G1020763			24468 19,1 +/W/Acc	BRE	
	140 Natural Power 2.0 D 115 Multijet 2.2 D 100 Multijet 2.3 D 120 Multijet 2.3 D 130 Multijet 2.3 D 150 Multijet 3.0 D 150 Multijet 3.0 D 160 Multijet 3.0 D Multijet	100 85 74 88 96 109 107 116 130		04.09 06.11 07.06 07.06 01.07 06.11 04.10 07.06 06.11	light payload 170 <sup>2)</sup> light payload 170 <sup>2)</sup> light payload 170 <sup>2)</sup> light payload 170 <sup>2)</sup> light payload 170 <sup>2)</sup> light payload 170 <sup>2)</sup> light payload 170 <sup>2)</sup> light payload 170 <sup>2)</sup> light payload 170 <sup>2)</sup>			G1020872			24468 19,1 +/W/Acc	BRE	
	140 Natural Power 2.0 D 115 Multijet 2.2 D 100 Multijet 2.3 D 120 Multijet 2.3 D 130 Multijet 2.3 D 150 Multijet 3.0 D 150 Multijet 3.0 D 160 Multijet 3.0 D Multijet	100 85 74 88 96 109 107 116 130		04.09 06.11 07.06 07.06 01.07 06.11 04.10 07.06 06.11	heavy payload 170 <sup>3)</sup> heavy payload 170 <sup>3)</sup> heavy payload 170 <sup>3)</sup> heavy payload 170 <sup>3)</sup> heavy payload 170 <sup>3)</sup> heavy payload 170 <sup>3)</sup> heavy payload 170 <sup>3)</sup> heavy payload 170 <sup>3)</sup> heavy payload 170 <sup>3)</sup>			G1020764			24466 19,1 +/W/Acc	BRE	
	140 Natural Power 2.0 D 115 Multijet 2.2 D 100 Multijet 2.3 D 120 Multijet 2.3 D 130 Multijet 2.3 D 150 Multijet 3.0 D 150 Multijet 3.0 D 160 Multijet 3.0 D Multijet	100 85 74 88 96 109 107 116 130		04.09 06.11 07.06 07.06 01.07 06.11 04.10 07.06 06.11	payload 200 <sup>4)</sup> payload 200 <sup>4)</sup> payload 200 <sup>4)</sup> payload 200 <sup>4)</sup> payload 200 <sup>4)</sup> payload 200 <sup>4)</sup> payload 200 <sup>4)</sup> payload 200 <sup>4)</sup> payload 200 <sup>4)</sup>			G1020873			24466 19,1 +/W/Acc	BRE	
	140 Natural Power 2.0 D 115 Multijet 2.2 D 100 Multijet 2.3 D 120 Multijet 2.3 D 130 Multijet 2.3 D 150 Multijet 3.0 D 150 Multijet 3.0 D 160 Multijet 3.0 D Multijet	100 85 74 88 96 109 107 116 130		04.09 06.11 07.06 07.06 01.07 06.11 04.10 07.06 06.11	payload 110/150 <sup>1)</sup> payload 110/150 <sup>1)</sup> payload 110/150 <sup>1)</sup> payload 110/150 <sup>1)</sup> payload 110/150 <sup>1)</sup> payload 110/150 <sup>1)</sup> payload 110/150 <sup>1)</sup> payload 110/150 <sup>1)</sup> payload 110/150 <sup>1)</sup>			G2124127			280 24,0 21,9 V +C		
	140 Natural Power 2.0 D 115 Multijet 2.2 D 100 Multijet 2.3 D 120 Multijet	100 85 74 88		04.09 06.11 07.06 07.06	heavy payload 170 <sup>3)</sup> heavy payload 170 <sup>3)</sup> heavy payload 170 <sup>3)</sup> heavy payload 170 <sup>3)</sup>			G2124138				300 24,0 21,9 V +C	

<sup>1)</sup> carico utile 110/150 / charge utile 110/150 / carga útil 110/150 / Nutzlast 110/150  
<sup>2)</sup> carico utile leggero 170 / charge utile légère 170 / carga útil ligera 170 / Nutzlast leicht 170  
<sup>3)</sup> carico utile pesante 170 / charge utile lourde 170 / carga útil pesada 170 / Nutzlast schwer 170  
<sup>4)</sup> carico utile 200 / charge utile 200 / carga útil 200 / Nutzlast 200





















FIAT DUCATO (06-)										
	2.3 D 130 Multijet	96		01.07	heavy payload 17Q <sup>1)</sup>	G2124138			300 24,0 21,9 V +C	
	2.3 D 150 Multijet	109		06.11	heavy payload 17Q <sup>1)</sup>					
	3.0 D 150 Multijet	107		04.10	heavy payload 17Q <sup>1)</sup>					
	3.0 D 160 Multijet	116		07.06	heavy payload 17Q <sup>1)</sup>					
	3.0 D Multijet	130		06.11	heavy payload 17Q <sup>1)</sup>					
	140 Natural Power	100		04.09		G1020730			24465 19,2 /Acc/S	BRE
	2.0 D 115 Multijet	85		06.11						
	2.2 D 100 Multijet	74		07.06						
	2.3 D 120 Multijet	88		07.06						
	2.3 D 130 Multijet	96		01.07						
	2.3 D 150 Multijet	109		06.11						
	3.0 D 150 Multijet	107		04.10						
	3.0 D 160 Multijet	116		07.06						
	3.0 D Multijet	130		06.11						
	140 Natural Power	100		04.09	payload 110/15Q+ light 17Q <sup>2)</sup>	G2116124			280 16,0 14,2 +C	
	2.0 D 115 Multijet	85		06.11	payload 110/15Q+ light 17Q <sup>2)</sup>					
	2.2 D 100 Multijet	74		07.06	payload 110/15Q+ light 17Q <sup>2)</sup>					
	2.3 D 120 Multijet	88		07.06	payload 110/15Q+ light 17Q <sup>2)</sup>					
	2.3 D 130 Multijet	96		01.07	payload 110/15Q+ light 17Q <sup>2)</sup>					
	2.3 D 150 Multijet	109		06.11	payload 110/15Q+ light 17Q <sup>2)</sup>					
	3.0 D 150 Multijet	107		04.10	payload 110/15Q+ light 17Q <sup>2)</sup>					
	3.0 D 160 Multijet	116		07.06	payload 110/15Q+ light 17Q <sup>2)</sup>					
	3.0 D Multijet	130		06.11	payload 110/15Q+ light 17Q <sup>2)</sup>					
	140 Natural Power	100		04.09	payload 20Q <sup>3)</sup>	G2116123			300 16,0 14,2 +C	
	2.0 D 115 Multijet	85		06.11	payload 20Q <sup>3)</sup>					
	2.2 D 100 Multijet	74		07.06	payload 20Q <sup>3)</sup>					
	2.3 D 120 Multijet	88		07.06	payload 20Q <sup>3)</sup>					
	2.3 D 130 Multijet	96		01.07	payload 20Q <sup>3)</sup>					
	2.3 D 150 Multijet	109		06.11	payload 20Q <sup>3)</sup>					
	3.0 D 150 Multijet	107		04.10	payload 20Q <sup>3)</sup>					
	3.0 D 160 Multijet	116		07.06	payload 20Q <sup>3)</sup>					
3.0 D Multijet	130		06.11	payload 20Q <sup>3)</sup>						
FIAT FIORINO / FIORINO QUBO (08-)										
	1.3 D Multijet	55		09.08	- semi autom. Selespeed <sup>4)</sup>	G1020737			23706 18,0 +/M/Acc/S	BOS
	1.4	54		09.08						
	1.4 Natural Power	57		10.09						
	1.3 D Multijet	55		09.08	+ semi autom. Selespeed <sup>5)</sup>	G1201224			23706 18,0 +/M/Acc/S	BOS
	1.3 MPI	52		01.07						
	1.3 D Multijet	70		07.10						
	1.3 D Multijet	55		09.08		G2122197			258 22,0 20,2 V +C	
	1.3 MPI	52		01.07						
	1.4	54		09.08						
	1.4 Natural Power	57		10.09						
	1.3 D Multijet	70		07.10						
						G2122147			284 22,0 20,2 V +C	
FIAT IDEA (04-12)										
	1.2 i 16V	59		01.04	02.08	G1020740			23706 18,0 +/M/S	BOS
	1.4 i	57		11.05	02.08					
	1.4 i 16V	70		01.04	02.08					
	1.4 LPG	57		03.09	07.12					
	1.3 D Multijet	66		11.05	02.08	G1020614 G1020738			23708 19,0 /S	BOS
	1.3 D Multijet	70		05.08	07.12					
	1.3 JTD	51		01.04	02.08					
	1.6 D Multijet	88		05.08	07.12					
1.9 JTD	74		01.04	02.08						
	1.2 i 16V	59		01.04	02.08	G2122197			258 22,0 20,2 V +C	
	1.4 i	57		11.05	02.08					
	1.4 i 16V	70		01.04	02.08					
	1.4 LPG	57		03.09	07.12					
	1.3 D Multijet	66		11.05	02.08	G2122147			284 22,0 20,2 V +C	
	1.3 D Multijet	70		05.08	07.12					
	1.3 JTD	51		01.04	02.08					
	1.6 D Multijet	88		05.08	07.12					
1.9 JTD	74		01.04	02.08						
	1.6 D Multijet	88		05.08	07.12	G1020567			23601 13,7 /S	LUC
FIAT LINEA (07-11)										
	1.3 D Multijet	66		07.07	05.11	G1020737 G1020740			23706 18,0 +/M/Acc/S	BOS
	1.4			07.07	05.11					
	1.4 T-Jet			07.07	05.11	G1020738			23709 19,0 +/M/Acc/S	BOS
	1.6	80		07.08	05.11					
	1.6 D Multijet	77		01.09	05.11					
1.9 16V			07.08	05.11						
	1.3 D Multijet	66		07.07	05.11	G2122197			258 22,0 20,2 V +C	
	1.4			07.07	05.11					
	1.4 T-Jet			07.07	05.11	G2122147			284 22,0 20,2 V +C	
	1.6	80		07.08	05.11					
	1.6 D Multijet	77		01.09	05.11					
	1.9 16V			07.08	05.11					

<sup>1)</sup> carico utile pesante 17Q / charge utile lourde 17Q / carga útil pesada 17Q / Nutzlast schwer 17Q  
<sup>2)</sup> carico utile 110/15Q+ leggero 17Q / charge utile 110/15Q+ légère 17Q / carga útil 110/15Q+ ligera 17Q / Nutzlast 110/15Q+ leicht 17Q  
<sup>3)</sup> carico utile 20Q / charge utile 20Q / carga útil 20Q / Nutzlast 20Q  
<sup>4)</sup> - cambio semi autom.Selespeed / - boîte semi autom.Selespeed / - caja camb.semi autom.Selespeed / - Halbaautomatik Selespeed  
<sup>5)</sup> + cambio semi autom.Selespeed / + boîte semi autom.Selespeed / + caja camb.semi autom.Selespeed / + Halbaautomatik Selespeed

























							
<b>FIAT LINEA (07-11)</b>							
	1.4 T-Jet 1.6 1.6 D Multijet 1.9 16V	80 77		07.07 07.08 01.09 07.08	05.11 05.11 05.11 05.11	G1020568	23517 16,6 /S LUC
	1.4 T-Jet 1.6 1.6 D Multijet 1.9 16V	80 77		07.07 07.08 01.09 07.08	05.11 05.11 05.11 05.11	G2110190	252 10,0 9,0 +C
<b>FIAT MAREA (96-02)</b>							
	1.2 i 16V Saloon 1.4 i 12V 1.6 i 16V Saloon 1.9 TD	55		04.99 09.96 09.96 09.96	12.02 12.02 12.02 12.02	G1020340	21930 17,9 +/WI ATE
	1.2 i 16V Estate 1.6 i 16V Estate 1.8 i 16V 1.9 JTD 1.9 TD	74		04.99 09.96 09.96 04.99 09.96	12.02 12.02 12.02 12.02 12.02	G1020342	21927 17,9 +/WI ATE
	2.0 i 20V 2.4 TD			09.96 09.96	04.99 04.99	G1020360	21636 19,3 +/WI ATE
	2.0 i 20V 2.4 JTD			05.99 04.99	12.02 12.02	G1020473	23289 19,3 +/WI ATE
	1.2 i 16V Saloon 1.4 i 12V 1.6 i 16V Saloon 1.9 TD	55		04.99 09.96 09.96 09.96	12.02 12.02 12.02 12.02	G2112127	258 12,0 10,2 +C
	1.2 i 16V Estate 1.6 i 16V Estate 1.8 i 16V 1.9 JTD 1.9 TD	74		04.99 09.96 09.96 04.99 09.96	12.02 12.02 12.02 12.02 12.02	G2120142	258 20,0 18,2 V L +C
	2.0 i 20V 2.4 JTD 2.4 TD			09.96 04.99 09.96	12.02 12.02 04.99	G2122147	284 22,0 20,2 V +C
	2.0 i 20V 2.4 JTD 2.4 TD			09.96 04.99 09.96	12.02 12.02 04.99	G1020236 G1020384	+ cast iron caliper 1) + aluminium calipers 2) 21103 14,2 /S LUC 23177 14,2 /S LUC
<b>FIAT MULTIPLA (98-08)</b>							
	1.6 1.6 16V 1.6 16V Bipower 1.9 JTD			09.00 02.99 04.99 02.99	02.01 09.04 03.02 09.04	G1020473 G1020360	23289 19,3 +/WI ATE 21636 19,3 +/WI ATE
	1.6 16V 1.6 16V Bluepower 1.9 JTD			10.04 04.99 10.04	02.08 02.08 02.08	G1020738	23709 19,0 +/WI/Acc/S BOS
	1.6 1.6 16V 1.9 JTD			09.00 04.02 04.02	02.01 11.05 11.05	G1020515	23714 16,6 /S BOS
	1.6 16V 1.6 16V Bluepower 1.9 JTD			12.05 04.99 12.05	02.08 02.08 02.08	G1020515 G1201128	23714 16,6 /S BOS 23714 17,6 +/WI/Acc/S BOS
	1.6 1.6 16V 1.6 16V Bipower 1.6 16V Bluepower 1.9 JTD			09.00 04.02 04.99 04.99 04.02	02.01 02.08 03.02 02.08 02.08	G2110190	252 10,0 9,0 +C
<b>FIAT PALIO / PALIO WEEKEND EUROPE (97-06)</b>							
	1.2 (75) 1.7 TD (70)			10.97 10.97	02.98 02.98	G1020389	23218 18,0 +/WI ATE
	1.2 (75) 1.7 TD (70)			03.98 03.98	11.98 11.98	G1020427	23220 18,0 +/WI ATE
	1.2 (75) 1.6 i 16V (100) 1.7 TD (70) 1.9 D			12.98 10.00 12.98 03.01	12.06 12.06 12.06 12.06	G1020448	23552 18,1 + ATE
	1.2 (75) 1.6 i 16V (100) 1.7 TD (70) 1.9 D			12.98 10.97 12.98 03.01	12.06 12.06 12.06 12.06	G2120142	258 20,0 18,2 V L +C
<b>FIAT PALIO SW / SIENA (PL) (98-06)</b>							
	1.4 1.6 i 16V			04.98 04.98	12.06 12.06	G1020427	23220 18,0 +/WI ATE
<b>FIAT PANDA (86-02)</b>							
	1000 1000 i.e. 1100 4x4 750 900			01.86 10.87 02.91 01.86 01.86 04.92	12.92 12.02 12.02 + manual transmission 3) 12.02 12.97 12.96	G1020141	20775 18,0 /WI BDJ

1) + pinza in ghisa / + étriers en fonte grise / + fundición gris-pinza / + GG-Sättel

2) + pinze in alluminio / + étriers en aluminium / + pinzas de aluminio / + ALU-Sättel

3) + scatola cambio velocità / + transmission mécanique / + cambio de velocidad / + Schaltgetriebe

        												
<b>FIAT PANDA (86-02)</b>												
	1100			02.91	12.02	+ autom.transmission 1)	G1020140			20839	17,0 /W/S	LUC
<b>FIAT PANDA (03-13)</b>												
	1.1 i	40		09.03	06.13		G1020621			21436	17,0 /WD/Acc	BOS
	1.2	51		03.10	06.13		G1020305			21436	16,2	BDX
	1.2 i	44		09.03	06.13							
	1.2 4x4	51		10.10	06.13		G1020613			24072	17,9 /Acc/S	BOS
	1.2 Bi-Power	44		01.07	06.13							
	1.2 i 4x4	44		10.04	06.13							
	1.2 LPG	44		04.09	06.13							
	1.2 LPG	51		11.10	06.13							
	1.3 D Multijet			09.03	06.13							
	1.3 JTD	51		09.03	06.13							
1.3 JTD	55		06.06	06.13								
1.4 Bi-/Natural Power			01.07	06.13								
1.3 D Multijet 4x4			10.04	06.13		G1020737			23706	18,0 +/W/Acc/S	BOS	
1.4	74		11.06	06.13		G1020987			23707	18,0 /Acc/S	BOS	
	1.2 4x4	51		10.10	06.13		G2120184			241	20,0 18,2 V +C	
	1.2 Bi-Power	44		01.07	06.13							
	1.2 i 4x4	44		10.04	06.13							
	1.2 LPG	44		04.09	06.13							
	1.2 LPG	51		11.10	06.13							
	1.3 D Multijet			09.03	06.13							
	1.3 JTD	51		09.03	06.13							
	1.3 JTD	55		06.06	06.13							
	1.4 Bi-/Natural Power			01.07	06.13							
	1.3 D Multijet 4x4			10.04	06.13		G2122197			258	22,0 20,2 V +C	
1.4	74		11.06	06.13								
	1.2 4x4	51		10.10	06.13		G1020567			23601	13,7 /S	LUC
	1.2 i 4x4	44		10.04	06.13							
	1.3 D Multijet 4x4			10.04	06.13							
	1.4	74		11.06	06.13							
<b>FIAT PANDA SUV (06-)</b>												
	1.3 JTD 4x4 Cross	51		04.06			G1020737			23706	18,0 +/W/Acc/S	BOS
							G1020987			23707	18,0 /Acc/S	BOS
	1.3 JTD 4x4 Cross	51		04.06			G2122197			258	22,0 20,2 V +C	
	1.3 JTD 4x4 Cross	51		04.06			G1020567			23601	13,7 /S	LUC
<b>FIAT PANDA (12-)</b>												
	0.9	57		02.12			G2122197		for light alloy rims series 2 2) for light alloy rims series 3 3)	258	22,0 20,2 V +C	
	0.9	63		02.12			G2112127			258	12,0 10,2 +C	
	0.9 4x4	63		09.12								
	0.9 CNG	63		07.12								
	0.9 Twinair Turbo NP	59		02.12								
	1.3 D Multijet	55		02.12								
	1.3 D Multijet 4x4	55		06.12								
	0.9	48		02.12			G2112127			258	12,0 10,2 +C	
	1.2	51		02.12								
	1.2 LPG	51		02.12								
	0.9 4x4	63		09.12			G2112127		+ light alloy rims 4)	258	12,0 10,2 +C	
	1.3 D Multijet 4x4	55		06.12								
<b>FIAT PUNTO (93-00)</b>												
	1.1 i (55)			11.93	09.99		G1020305			21436	16,2	BDX
	1.2 i (60) Convert.			03.94	06.00		G1020298			21436	16,2 /W/I	BDX
	1.2 i (60/75) Saloon			11.93	09.99							
	1.7 D			01.95	05.97							
	1.2 i (60) Convert.			03.94	06.00		G1020140			20839	17,0 /W/S	LUC
	1.2 i (60/75) Saloon			11.93	09.99							
	1.4 GT			11.93	05.97							
	1.6 i (90) Convert.			03.94	05.97							
	1.6 i (90) Saloon			03.94	05.97							
	1.7 TD			11.93	05.97							
	1.2 i 16V (85) Conv.			06.97	06.00		G1020351			23181	17,9 +	ATE
	1.2 i 16V (85) Saloon			06.97	09.99							
	1.7 TD			06.97	09.99							
	1.4 GT			06.97	09.99		G1020342			21927	17,9 +/W/I	ATE
	1.2 i (60) Convert.			03.94	05.97		G2112127			258	12,0 10,2 +C	
	1.2 i (60/75) Saloon			11.93	05.97							
	1.2 i 16V (85) Conv.			06.97	06.00							
	1.2 i 16V (85) Saloon			06.97	09.99							
1.4 GT			11.93	09.99		G2120142			258	20,0 18,2 V L +C		

1) + scatola cambio automatico / + transmission automatique / + cambio automático / + Automatikgetriebe  
2) per cerchione in lega serie 2 / pour jantes en alliage léger série 2 / para Llantas de aleación serie 2 / für Leichtmetallfelgen Serie 2  
3) per cerchione in lega serie 3 / pour jantes en alliage léger série 3 / para Llantas de aleación serie 3 / für Leichtmetallfelgen Serie 3  
4) + cerchioni in lega / + jantes en alliage léger / + Llantas de aleación ligera / + Leichtmetallfelgen



















<b>FIAT PUNTO (93-00)</b>										
	1.4 GT			11.93	05.97		G1020236	+ cast iron caliper <sup>1)</sup>	21103 14,2 /S	LUC
	1.4 GT			06.97	09.99		G1020384	+ aluminium calipers <sup>2)</sup>	23177 14,2 /S	LUC
<b>FIAT PUNTO (00-03)</b>										
	1.2 i			10.99	06.03		G1020305 G1020298		21436 16,2 21436 16,2 /WI	BDX BDX
	1.2 i 16V			10.99	06.03	+ manual transmission <sup>3)</sup>	G1020351		23181 17,9 +	ATE
	1.2 i 16V			10.99	06.03	+ autom.transmission <sup>4)</sup>	G1020469		21930 17,9 +	ATE
	1.9 D			10.99	06.03					
	1.8 i 16V			10.99	06.03		G1020448		23552 18,1 +	ATE
	1.9 JTD			10.99	06.03		G1020484		21927 17,9 +	ATE
	1.2 i 16V			10.99	06.03		G2112127		258 12,0 10,2 +C	
	1.9 D			10.99	06.03					
	1.8 i 16V			10.99	06.03		G2122197		258 22,0 20,2 V +C	
	1.9 JTD			10.99	06.03		G2120142		258 20,0 18,2 V L +C	
	1.8 i 16V			10.99	06.03		G1020567		23601 13,7 /S	LUC
<b>FIAT PUNTO (03-06)</b>										
	1.2 i			07.03	11.05		G1020305		21436 16,2	BDX
	1.2 i 16V			07.03	11.05		G1020351		23181 17,9 +	ATE
	1.3 JTD 16V			07.03	11.05		G1020484		21927 17,9 +	ATE
	1.4 i 16V			07.03	11.05					
	1.9 JTD	63		07.03	11.05					
	1.8 i 16V			07.03	11.05		G1020473		23289 19,3 +/WI	ATE
	1.9 JTD	74		07.03	11.05					
	1.2 i			07.03	11.05		G2112127		258 12,0 10,2 +C	
	1.2 i 16V			07.03	11.05					
	1.3 JTD 16V			07.03	11.05		G2120142		258 20,0 18,2 V L +C	
	1.4 i 16V			07.03	11.05					
	1.9 JTD	63		07.03	11.05					
	1.8 i 16V			07.03	11.05		G1020567		23601 13,7 /S	LUC
	1.9 JTD	74		07.03	11.05					
<b>FIAT PUNTO / PUNTO EVO (09-)</b>										
	1.3 D Multijet	51		10.09			G1201225		23709 19,0 +/WI/Acc/S	BOS
	1.3 D Multijet	66		10.09						
	1.3 D Multijet	70		10.09						
	1.4 16V	99		10.09						
	1.6 D Multijet	88		10.09						
	1.2	48		10.09	04.10		G1201224		23706 18,0 +/WI/Acc/S	BOS
	1.2	51		10.09	04.10					
	1.3 D Multijet	55		10.09	04.10					
	1.3 D Multijet	62		10.09	04.10					
	1.4			10.09	04.10					
	1.4 16V	77		10.09	04.10					
	1.4 LPG	57		06.09	04.10					
	1.4 Natural Power	57		10.09	04.10					
	0.9 Bifuel	63		03.12			G2122231		257 22,0 20,0 V +S +C	
	0.9 Twinair Turbo	63		03.12						
	1.2	48		10.09						
	1.3 D Multijet	51		07.08						
	1.3 D Multijet	55		10.09						
	1.3 D Multijet	62		10.09						
	1.4			10.09						
	1.4 16V	77		10.09						
	1.4 16V	99		10.09						
	1.4 LPG	57		06.09						
	1.4 MultiAir	77		03.12						
	1.4 MultiAir	99		03.12						
	1.4 Natural Power	57		10.09						
<b>FIAT GRANDE PUNTO (06-11)</b>										
	1.2			10.05	08.10		G1020737		23706 18,0 +/WI/Acc/S	BOS
	1.3 D Multijet	51		10.05	08.10					
	1.4			10.05	08.10					
	1.4 16V			10.05	01.11					
	1.4 LPG	57		12.08	01.11					
	1.4 Natural Power	57		07.08	01.11					
	1.3 D Multijet	66		10.05	01.11		G1020738		23709 19,0 +/WI/Acc/S	BOS
	1.4 T-Jet	88		07.07	01.11					
	1.6 D Multijet	88		07.08	01.11					
	1.9 JTD			10.05	01.11					
	1.9 JTD	96		02.06	01.11					
	1.2			09.10	01.11		G1201224		23706 18,0 +/WI/Acc/S	BOS
	1.2	51		09.10	01.11					
	1.3 D Multijet	51		09.10	01.11					
	1.3 D Multijet	55		09.10	01.11					
	1.4			09.10	01.11					
	1.3 D Multijet	62		04.10	01.11		G1201225		23709 19,0 +/WI/Acc/S	BOS

<sup>1)</sup> + pinza in ghisa / + étriers en fonte grise / + fundición gris-pinza / + GG-Sättel  
<sup>2)</sup> + pinze in alluminio / + étriers en aluminium / + pinzas de aluminio / + ALU-Sättel  
<sup>3)</sup> + scatola cambio velocità / + transmission mécanique / + cambio de velocidad / + Schaltgetriebe  
<sup>4)</sup> + scatola cambio automatico / + transmission automatique / + cambio automático / + Automatikgetriebe





















<b>FIAT GRANDE PUNTO (06-11)</b>															
	1.2			10.05	01.11			G2112184 G2122231	- ventilated discs <sup>1)</sup> + ventilated discs <sup>2)</sup>		257 12,0 10,0 +S +C 257 22,0 20,0 V +S +C				
	1.2	51		09.10	01.11			G2122231			257 22,0 20,0 V +S +C				
	1.3 D Multijet	51		10.05	01.11										
	1.3 D Multijet	55		04.08	01.11										
	1.4			10.05	01.11										
	1.4 16V			10.05	01.11										
	1.4 LPG	57		12.08	01.11										
1.4 Natural Power	57		07.08	01.11											
<b>FIAT SCUDO (95-06)</b>															
	1.6 i.e.			11.95	12.06			G1020350			23042 19,0 +WV/Acc			BDX	
	1.9 D			11.95	12.06										
	1.9 TD			11.95	12.06										
	2.0 i 16V			06.00	12.06										
	2.0 JTD			12.99	12.06										
	1.6 i.e.			11.95	09.03			G1020310			21801 19,0 +WV/S			LUC	
	1.9 D			11.95	09.03										
	1.9 TD			11.95	09.03										
	2.0 i 16V			06.00	09.03										
	2.0 JTD			12.99	09.03										
	1.6 i.e.			10.03	12.06			G1020514			20261 19,0 +WV/S			LUC	
	1.9 D			10.03	12.06										
	1.9 TD			10.03	12.06										
	2.0 i 16V			10.03	12.06										
	2.0 JTD			10.03	12.06										
	1.6 i.e.			11.95	12.06			G2120155			258 20,0 18,2 V L +C				
	1.9 D			11.95	12.06										
	1.9 TD			11.95	12.06										
	2.0 i 16V			06.00	12.06										
	2.0 JTD			12.99	12.06										
<b>FIAT SCUDO (07-)</b>															
	1.6 D Multijet	66		01.07				G1020937			24595 18,5 +WV/Acc/S			LUC	
	2.0	103		03.07											
	2.0 D Multijet	88		01.07											
	2.0 D Multijet	94		04.11											
	2.0 D Multijet	100		01.07											
	2.0 D Multijet 4x4	120		07.10											
	1.6 D Multijet	66		01.07				G1020938			24578 16,5 /Acc/S			LUC	
	2.0	103		03.07											
	2.0 D Multijet	88		01.07											
	2.0 D Multijet	94		04.11											
	2.0 D Multijet	100		01.07											
	2.0 D Multijet 4x4	120		07.10											
<b>FIAT SEDICI (06-)</b>															
	1.6 16V	79		06.06				G1020774			24391 16,6 +WV/Acc/S			LUC	
	1.6 16V	88		06.06											
	1.6 16V 4x4	79		06.06											
	1.6 16V 4x4	88		06.06											
	1.9 D Multijet	88		06.06											
	1.9 D Multijet 4x4	88		06.06											
	2.0 D Multijet	99		06.06											
2.0 D Multijet 4x4	99		06.06												
<b>FIAT SEICENTO (98-08)</b>															
	1100 i.e.			04.98	03.08			G1020305			21436 16,2			BDX	
	900 i.e.			04.98	03.08										
<b>FIAT STILO / STILO Multi Wagon (01-08)</b>															
	1.2 i 16V	59		02.02	03.08			G1020740			23706 18,0 +WV/S			BOS	
	1.4 i 16V			01.04	03.08										
	1.6 16V			10.01	03.08										
	1.8 16V			10.01	03.08			G1020503			23708 19,0 +WV/S			BOS	
	1.9 D Multijet			09.05	03.08										
	1.9 JTD			02.02	03.08										
	1.9 JTD			10.01	03.08										
	1.6 16V	100		04.05	03.08			G1020504			23711 19,4 +WV/S			BOS	
	1.9 D Multijet	110		09.05	03.08										
	1.9 JTD			01.04	03.08										
	2.4 20V			10.01	03.08										
	1.2 i 16V	59		02.02	03.08			G2122197			258 22,0 20,2 V +C				
	1.4 i 16V			01.04	03.08										
	1.6 16V			10.01	03.08										
	1.8 16V			10.01	03.08			G2122147			284 22,0 20,2 V +C				
	1.9 D Multijet			09.05	03.08										
	1.9 JTD			02.02	03.08										
	1.9 JTD			10.01	03.08										

















<sup>1)</sup> - dischi ventilati / - disques ventilés / - disco ventilado / - belüftete Scheiben





















<sup>2)</sup> + dischi ventilati / + disques ventilés / + disco ventilado / + belüftete Scheiben

														
<b>FIAT STILO / STILO Multi Wagon (01-08)</b>														
	1.2 i 16V	59		02.02	05.05	G1020515		23714 16,6 /S	BOS					
	1.4 i 16V			01.04	05.05									
	1.6 16V			10.01	05.05									
	1.6 16V	100		04.05	05.05									
	1.8 16V			10.01	05.05									
	1.9 JTD			02.02	05.05									
	1.9 JTD			10.01	05.05									
	1.9 JTD			01.04	05.05									
	2.4 20V			10.01	05.05									
	1.2 i 16V	59		06.05	03.08									
	1.4 i 16V			06.05	03.08									
	1.6 16V			06.05	03.08									
	1.6 16V	100		06.05	03.08									
	1.8 16V			06.05	03.08									
1.9 D Multijet			09.05	03.08										
1.9 D Multijet	110		09.05	03.08										
1.9 JTD			06.05	03.08										
1.9 JTD			06.05	03.08										
1.9 JTD			06.05	03.08										
2.4 20V			06.05	03.08										
	1.2 i 16V	59		02.02	03.08	G2110190		252 10,0 9,0 +C						
	1.4 i 16V			01.04	03.08									
	1.6 16V			10.01	03.08									
	1.6 16V	100		04.05	03.08									
	1.8 16V			10.01	03.08									
	1.9 D Multijet			09.05	03.08									
	1.9 D Multijet	110		09.05	03.08									
	1.9 JTD			02.02	03.08									
	1.9 JTD			10.01	03.08									
	1.9 JTD			01.04	03.08									
	2.4 20V			10.01	03.08									
	<b>FIAT STRADA / PICK-UP (99-)</b>													
		1.2			05.99						G1020448		23552 18,1 +	ATE
		1.3 JTD	62		05.06									
1.7 TD		51		05.99										
1.9 D		46		12.00										
1.9 JTD		59		04.03										
	1.2			05.99		G2120142		258 20,0 18,2 V L +C						
	1.3 JTD	62		05.06										
	1.7 TD	51		05.99										
	1.9 D	46		12.00										
	1.9 JTD	59		04.03										
<b>FIAT STRADA II (11-)</b>														
	1.3 D Multijet	70		01.11		G2120142		258 20,0 18,2 V L +C						
<b>FIAT TALENTO (88-94)</b>														
	1.9 D			10.88	12.94	G1020147		20741 19,0 +M/S	LUC					
	2.0			07.90	12.94									
<b>FIAT TEMPRA (93-96)</b>														
	1.4 i.e.			05.93	09.96	G1020140		20839 17,0 M/S	LUC					
	1.6 i.e.			05.93	09.96									
	1.8 i.e.			05.93	09.96									
	1.9 D			05.93	09.96									
	1.9 TD			05.93	09.96									
	2.0 i.e.			05.93	09.96									
	2.0 i.e. 4x4			05.93	09.96									
	1.4 i.e. Estate			05.93	09.96	G2112127		258 12,0 10,2 +C						
	1.4 i.e. Saloon			05.93	09.96 + ABS									
	1.6 i.e. Estate			05.93	09.96									
	1.6 i.e. Saloon			05.93	09.96 + ABS/ + autom.transmission 1)									
	1.8 i.e. Saloon			05.93	09.96									
	1.9 D Estate			05.93	09.96									
	1.9 D Saloon			05.93	09.96 + ABS									
	1.9 TD Saloon			05.93	09.96									
	1.8 i.e. Estate			05.93	09.96									
1.9 TD Estate			05.93	09.96										
	2.0 i.e.			05.93	09.96	G2120142		258 20,0 18,2 V L +C						
	2.0 i.e. 4x4			05.93	09.96									
	1.4 i.e.			05.93	09.96 + ABS									
	1.6 i.e.			05.93	09.96 + ABS									
	1.8 i.e.			05.93	09.96 + ABS									
	1.9 D			05.93	09.96 + ABS	G1020236		21103 14,2 /S	LUC					
	1.9 TD			05.93	09.96 + ABS									
	2.0 i.e.			05.93	09.96									
	2.0 i.e. 4x4			05.93	09.96									

1) + ABS/ + scatola cambio autom. / + ABS/ + transmission automatique / + ABS/ + cambio automático / + ABS/ + Automatikgetriebe

							
<b>FIAT TIPO (93-95)</b>							
	1.4 i.e. 1.6 i.e. 1.7 D 1.8 i.e. 1.9 D 1.9 TD 2.0 i.e.	83	05.93 05.93 05.93 05.93 05.93 05.93 05.93	09.95 09.95 09.95 09.95 09.95 09.95 09.95	G1020140		20839 17,0 /W/S LUC
	1.4 i.e. 1.6 i.e. 1.8 i.e. 1.9 TD 2.0 i.e.	83	05.93 05.93 05.93 05.93 05.93	09.95 + ABS 09.95 + ABS 09.95 09.95 09.95	G2112127		258 12,0 10,2 +C
	1.4 i.e. 1.6 i.e. 1.7 D 1.8 i.e. 1.9 D 1.9 TD 2.0 i.e. 2.0 i.e. 16V	83	05.93 05.93 05.93 05.93 05.93 05.93 05.93 05.93	09.95 + ABS 09.95 + ABS 09.95 + ABS 09.95 + ABS 09.95 + ABS 09.95 + ABS 09.95 09.95	G1020236		21103 14,2 /S LUC
<b>FIAT ULYSSE (94-02)</b>							
	1.8 i.e. 1.9 TD 2.0 2.0 16V 2.0 JTD 2.0 Turbo 2.1 TD	89 108	06.96 01.95 06.94 06.94 10.99 06.94 06.96	07.02 07.02 07.02 07.02 07.02 07.02 10.99	G1020350 G1020310		23042 19,0 /W/Acc BDX 21801 19,0 +/W/S LUC
	1.8 i.e.		06.96	07.02	G2120155		258 20,0 18,2 V L +C
	1.8 i.e. 1.9 TD 2.0 2.0 16V 2.0 JTD 2.0 Turbo 2.1 TD	89 108	06.96 01.95 06.94 06.94 10.99 06.94 06.96	07.02 + ABS 07.02 + ABS 07.02 + ABS 07.02 + ABS 07.02 + ABS 07.02 + ABS 10.99 + ABS	G1020291		21275 17,0 +/W/A TE
<b>FIAT ULYSSE (02-11)</b>							
	2.0 D Multijet 2.0 D Multijet 2.0 i 16V 2.0 JTD 2.0 JTD 2.2 JTD 2.2 JTD	88 100 100 79 80 94 120	05.06 05.06 08.02 05.03 08.02 08.02 03.08	01.11 01.11 01.11 01.11 01.11 01.11 01.11	G1020514		20261 19,0 +/W/S LUC
	2.0 D Multijet 2.0 D Multijet 2.0 i 16V 2.0 JTD 2.0 JTD 2.2 D Multijet 2.2 JTD 2.2 JTD 3.0 i V6	88 100 100 79 80 125 94 120 150	05.06 05.06 08.02 05.03 08.02 03.08 08.02 03.08 08.02	01.11 01.11 01.11 01.11 01.11 01.11 01.11 01.11 01.11	G1020549		20961 17,1 /W/D/S LUC
<b>FORD C-MAX I (07-10)</b>							
	1.6 i 16V 1.6 TDCi 1.6 TDCi 1.8 i 16V 1.8 TDCi 2.0 i 16V 2.0 TDCi 2.0 TDCi	74 66 85 107 81	03.07 03.07 03.07 03.07 03.07 03.07 02.08	10.10 10.10 10.10 10.10 10.10 10.10 10.10	G1020622		23723 18,1 + ATE
	1.8 TDCi 2.0 i 16V 2.0 TDCi 2.0 TDCi	85 107 81	03.07 03.07 03.07 02.08	10.10 10.10 10.10 10.10	G2125162		300 25,0 23,0 V L +C
	1.6 i 16V 1.6 TDCi 1.6 TDCi 1.8 i 16V	74 66	03.07 03.07 03.07 03.07	10.10 10.10 10.10 10.10	G2125117		278 25,0 23,0 V L +C
	1.6 i 16V 1.6 TDCi 1.6 TDCi 1.8 i 16V 1.8 TDCi 2.0 i 16V 2.0 TDCi 2.0 TDCi	74 66 85 107 81	03.07 03.07 03.07 03.07 03.07 03.07 02.08	10.10 10.10 10.10 10.10 10.10 10.10 10.10	G1020727		23482 16,6 + ATE

								
<b>FORD C-MAX I (07-10)</b>								
	1.6 i 16V	74		03.07	10.10		G2111155	265 11,0 9,0 +C
	1.6 TDCi			03.07	10.10			
	1.6 TDCi	66		03.07	10.10			
	1.8 i 16V			03.07	10.10			
	1.8 TDCi	85		03.07	10.10		G2111158	280 11,0 9,0 +S +C
	2.0 i 16V	107		03.07	10.10			
	2.0 TDCi			03.07	10.10			
	2.0 TDCi	81		02.08	10.10			
<b>FORD C-MAX II (10-)</b>								
	1.0 EcoBoost	74		09.12			G1020622	23723 18,1 + ATE
	1.0 EcoBoost	92		09.12				
	1.6 EcoBoost	110		12.10				
	1.6 EcoBoost	134		12.10				
	1.6 Flexifuel	88		02.11				
	1.6 LPG	88		02.12				
	1.6 TDCi	70		12.10				
	1.6 TDCi	85		12.10				
	1.6 Ti-VCT	63		12.10				
	1.6 Ti-VCT	77		12.10				
	1.6 Ti-VCT	92		12.10				
	2.0 TDCi	85		12.10				
	2.0 TDCi	103		12.10				
	2.0 TDCi	120		12.10				
	1.0 EcoBoost	74		09.12			G2125199	278 25,0 23,0 V L +C
	1.0 EcoBoost	92		09.12				
	1.6 Flexifuel	88		02.11				
	1.6 LPG	88		02.12				
	1.6 TDCi	70		12.10				
	1.6 TDCi	85		12.10				
	1.6 Ti-VCT	63		12.10				
	1.6 Ti-VCT	77		12.10				
	1.6 Ti-VCT	92		12.10				
	1.6 EcoBoost	110		12.10			G2125162	300 25,0 23,0 V L +C
	1.6 EcoBoost	134		12.10			G2125199	278 25,0 23,0 V L +C
	2.0 TDCi	85		12.10				
	2.0 TDCi	103		12.10				
	2.0 TDCi	120		12.10				
	1.0 EcoBoost	74		09.12			G1020727	23482 16,6 + ATE
	1.0 EcoBoost	92		09.12				
	1.6 EcoBoost	110		12.10				
	1.6 EcoBoost	134		12.10				
	1.6 Flexifuel	88		02.11				
	1.6 LPG	88		02.12				
	1.6 TDCi	70		12.10				
	1.6 TDCi	85		12.10				
	1.6 Ti-VCT	63		12.10				
	1.6 Ti-VCT	77		12.10				
	1.6 Ti-VCT	92		12.10				
	2.0 TDCi	85		12.10				
	2.0 TDCi	103		12.10				
	2.0 TDCi	120		12.10				
<b>FORD GRAND C-MAX (10-)</b>								
	1.0 EcoBoost	74		09.12			G1020622	23723 18,1 + ATE
	1.0 EcoBoost	92		09.12				
	1.6 EcoBoost	110		12.10				
	1.6 EcoBoost	134		12.10				
	1.6 Flexifuel	88		02.11				
	1.6 LPG	86		02.12				
	1.6 TDCi	70		12.10				
	1.6 TDCi	85		12.10				
	1.6 Ti-VCT	77		12.10				
	1.6 Ti-VCT	92		12.10				
	2.0 TDCi	85		12.10				
	2.0 TDCi	100		12.10				
	2.0 TDCi	103		12.10				
	2.0 TDCi	120		12.10				
	1.0 EcoBoost	74		09.12			G2125162	300 25,0 23,0 V L +C
	1.0 EcoBoost	92		09.12				
	1.6 EcoBoost	110		12.10				
	1.6 EcoBoost	134		12.10				
	1.6 Flexifuel	88		02.11				
	1.6 LPG	86		02.12				
	1.6 TDCi	70		12.10				
	1.6 TDCi	85		12.10				
	1.6 Ti-VCT	77		12.10				
	1.6 Ti-VCT	92		12.10				
	2.0 TDCi	85		12.10				
	2.0 TDCi	100		12.10				
	2.0 TDCi	103		12.10				
	2.0 TDCi	120		12.10				
	1.0 EcoBoost	74		09.12			G1020727	23482 16,6 + ATE
	1.0 EcoBoost	92		09.12				
	1.6 EcoBoost	110		12.10				
	1.6 EcoBoost	134		12.10				
	1.6 Flexifuel	88		02.11				

									
<b>FORD GRAND C-MAX (10-)</b>									
	1.6 LPG	86		02.12		G1020727		23482 16,6 +	ATE
	1.6 TDCi	70		12.10					
	1.6 TDCi	85		12.10					
	1.6 Ti-VCT	77		12.10					
	1.6 Ti-VCT	92		12.10					
	2.0 TDCi	85		12.10					
	2.0 TDCi	100		12.10					
	2.0 TDCi	103		12.10					
	2.0 TDCi	120		12.10					
<b>FORD COUGAR (98-00)</b>									
	2.0 i 16V			09.98	12.00	G1020320		21394 17,5 +	ATE
	2.5 i V6			09.98	12.00	G1020265		21396 17,5 +/WI	ATE
	2.0 i 16V			09.98	12.00	G2124120		260 24,0 22,2 V +C	
	2.0 i 16V			09.98	12.00	G1020885		21586 15,0	BDX
	2.5 i V6			08.99	12.00				
	2.5 i V6			09.98	07.99	G1020886		23410 15,0 +/WI	BDX
	2.0 i 16V			09.98	12.00	G2120146		253 20,0 18,0 V +C	
	2.5 i V6			09.98	12.00				
<b>FORD ESCORT / ORION (91-94)</b>									
	1.1			09.90	01.95	G1020423	+ spring <sup>1)</sup>	23300 18,0 +	BDX
	1.3			09.90	01.95				
	1.4			09.90	01.95				
	1.6			09.90	01.95				
	1.8 D			09.90	01.95				
	1.8 i 16V	77		01.92	01.95				
	1.8 TD			02.93	01.95				
	1.8 i 16V	96		01.92	01.95	G1020026		20907 18,0 +	ATE
	RS 2000			05.91	01.95				
	1.1			09.90	01.95	G2110196	- ABS	240 10,0 8,0 +C	
	1.3 Saloon			09.90	01.95		- ABS		
	1.1			09.90	01.95	G2120147	+ ABS	240 20,0 18,0 V +C	
	1.3 Estate			09.90	01.95				
	1.3 Saloon			09.90	01.95		+ ABS		
	1.3 Van			09.90	01.95				
	1.4			09.90	01.95				
	1.6			09.90	01.95				
	1.8 D			09.90	01.95				
	1.8 i 16V	77		01.92	01.95				
	1.8 TD			02.93	01.95				
	1.6			09.90	01.95	G1020290	+ ABS	21832 14,9	ATE
	1.8 D			09.90	01.95		+ ABS		
	1.8 i 16V			01.92	01.95		+ ABS		
	1.8 TD			02.93	01.95		+ ABS		
	RS 2000			05.91	01.95		+ ABS		
	1.6			09.90	01.95	G2110213	+ ABS	270 10,0 8,6 +C	
	1.8 D			09.90	01.95		+ ABS		
	1.8 i 16V			01.92	01.95		+ ABS		
	1.8 TD			02.93	01.95		+ ABS		
	RS 2000			05.91	01.95		+ ABS		
<b>FORD ESCORT VII (95-00)</b>									
	1.3 i			02.95	02.99	G1020423	+ spring <sup>1)</sup>	23300 18,0 +	BDX
	1.4 i			02.95	02.99				
	1.6 i 16V			02.95	07.00				
	1.8 D			02.95	02.99				
	1.8 i 16V	77		02.95	02.99				
	1.8 i 16V	85		02.95	02.99				
	1.8 TD			02.95	07.00				
	1.8 i 16V	96		02.95	02.99	G1020026		20907 18,0 +	ATE
	RS 2000			02.95	02.99				
	1.3 i			02.95	02.99	G2120147		240 20,0 18,0 V +C	
	1.4 i			02.95	02.99				
	1.6 i 16V			02.95	07.00				
	1.8 D			02.95	02.99				
	1.8 i 16V	77		02.95	02.99				
	1.8 i 16V	85		02.95	02.99				
	1.8 TD			02.95	07.00				
	1.6 i 16V			02.95	07.00	G1020290	+ ABS	21832 14,9	ATE
	1.8 D			02.95	02.99		+ ABS		
	1.8 i 16V			02.95	02.99		+ ABS		
	1.8 TD			02.95	07.00		+ ABS		
	1.6 i 16V			02.95	07.00	G2110213	+ ABS	270 10,0 8,6 +C	
	1.8 D			02.95	02.99		+ ABS		
	1.8 i 16V			02.95	02.99		+ ABS		
	1.8 TD			02.95	07.00		+ ABS		

<sup>1)</sup> + molla / + ressort / + muelle / + Feder























FORD FIESTA III (89-96)											
	1.0	33		03.89	12.95	G1020333 G1020334	- ventilated discs <sup>1)</sup> + ventilated discs <sup>2)</sup>	21202 16,9 + 20640 17,5 +	ATE ATE		
	1.1			05.89	11.96						
	1.3	44		03.89	11.96						
	1.3 Van			09.91	11.96						
	1.4			03.89	11.96						
	1.6			01.89	11.96						
	1.6 Turbo	96		03.90	10.92						
	1.6 XR2i			03.89	11.96						
	1.6i 16V	65		01.94	11.96						
	1.8 16V	77		02.92	11.96						
	1.8 D	44		05.89	11.96						
1.8 D Van			09.91	11.96							
1.8 XR2i	96		02.92	12.95							
	1.0	33		03.89	10.95	G2110196 G2120147	- ventilated discs <sup>1)</sup> + ventilated discs <sup>2)</sup>	240 10,0 8,0 +C 240 20,0 18,0 V +C			
	1.1			05.89	10.95						
	1.3	44		03.89	10.95						
	1.3 Van			09.91	10.95						
	1.4			03.89	10.95						
	1.6			01.89	10.95						
	1.6 Turbo	96		03.90	10.92						
	1.6 XR2i			03.89	10.95						
	1.6i 16V	65		01.94	10.95						
	1.8 16V	77		02.92	10.95						
	1.8 D	44		05.89	10.95						
	1.8 D Van			09.91	10.95						
	1.8 XR2i	96		02.92	10.95						
	1.0	33		11.95	12.95				G2112141 G2120147	- ventilated discs <sup>1)</sup> + ventilated discs <sup>2)</sup>	239 12,0 10,0 +C 240 20,0 18,0 V +C
	1.1			11.95	11.96						
	1.3	44		11.95	11.96						
	1.3 Van			11.95	11.96						
	1.4			11.95	11.96						
1.6			11.95	11.96							
1.6 XR2i			11.95	11.96							
1.6i 16V	65		11.95	11.96							
1.8 16V	77		11.95	11.96							
1.8 D	44		11.95	11.96							
1.8 D Van			11.95	11.96							
1.8 XR2i	96		11.95	12.95							

FORD FIESTA IV (96-02)																
	1.25 i 16V			01.96	01.00	G1020333		21202 16,9 +	ATE							
	1.3 i Saloon			01.96	01.00					+ manual transmission <sup>3)</sup>						
	1.8 D Saloon			01.96	01.00											
	1.25 i 16V			01.96	01.00					G1020334		20640 17,5 +	ATE			
	1.3 i Van			01.96	01.00									+ autom.transmission <sup>4)</sup>		
	1.4 i 16V			02.96	01.00											
1.6 i 16V			10.99	01.00												
1.8 D Van			01.96	01.00												
	1.25 i 16V			02.00	03.02	G1020467 G1020519	- ABS + ABS	23200 18,0 + 23604 17,8 +	ATE ATE							
	1.3 i			02.00	03.02											
	1.4 i 16V			02.00	03.02											
	1.6	65		02.00	03.02											
	1.6 i 16V			02.00	03.02											
	1.8 D			02.00	03.02											
	1.8 DI			03.00	03.02											
		1.25 i 16V			01.96					01.00	G2112141		239 12,0 10,0 +C			
		1.3 i Saloon			01.96					01.00				+ manual transmission <sup>3)</sup>		
		1.8 D Saloon			01.96					01.00						
		1.25 i 16V			01.96					01.00				G2120147		240 20,0 18,0 V +C
		1.3 i Van			01.96					01.00						
1.4 i 16V				02.96	01.00											
1.6 i 16V			10.99	01.00												
1.8 D Van			01.96	01.00												
	1.25 i 16V			02.00	03.02	G2120147 G2122172	- ABS + ABS	240 20,0 18,0 V +C 258 22,0 20,0 V +C								
	1.3 i			02.00	03.02											
	1.4 i 16V			02.00	03.02											
	1.6	65		02.00	03.02											
	1.6 i 16V			02.00	03.02											
	1.8 D			02.00	03.02											
1.8 DI			03.00	03.02												

FORD FIESTA V (02-08)													
	1.25 i 16V	51		03.03	08.08	G1020519		23604 17,8 +	ATE				
	1.25 i 16V	55		05.02	08.08								
	1.3 i	44		04.02	08.08								
	1.3 i	51		04.02	08.08								
	1.4 i 16V	59		04.02	08.08								
	1.4 TDCi	50		04.02	08.08								
	1.6 i 16V	74		04.02	08.08								
	1.6 TDCi	66		10.04	08.08								
	ST 150	110		11.04	08.08					G1020692		23440 17,6 +	ATE
		1.25 i 16V	51		03.03					08.08	G2122172		258 22,0 20,0 V +C
1.25 i 16V		55		05.02	08.08								
1.3 i		44		04.02	08.08								
1.4 i 16V		59		04.02	08.08								

1) - dischi ventilati / - disques ventilés / - disco ventilado / - belüftete Scheiben  
2) + dischi ventilati / + disques ventilés / + disco ventilado / + belüftete Scheiben  
3) + scatola cambio velocità / + transmission mécanique / + cambio de velocidad / + Schaltgetriebe  
4) + scatola cambio automatico / + transmission automatique / + cambio automático / + Automatikgetriebe

							
<b>FORD FIESTA V (02-08)</b>							
	1.4 TDCi 1.6 i 16V 1.6 TDCi	50 74 66		04.02 04.02 10.04	08.08 08.08 08.08	G2122172	258 22,0 20,0 V +C
	ST 150	110		11.04	08.08	G1020507	23353 14,6 /WD/S LUC
	ST 150	110		11.04	08.08	G2110115	253 10,2 8,9 +C
<b>FORD FIESTA VI (08-)</b>							
	1.25 i 16V 1.25 i 16V 1.4 Duratec LPG 1.4 i 16V 1.4 TDCi 1.4 TDCi 1.6 TDCi 1.6 TDCi 1.6 TDCi 1.6 Ti-VCT 1.6 Ti-VCT	44 60 71 50 51 55 66 70 88 99		09.08 09.08 06.09 09.08 01.09 07.10 09.08 09.08 02.10 09.08 12.10	04.12 04.12 04.12 04.12 04.12 04.12 04.12 04.12 04.12 04.12 04.12	G1201053	24283 15,5 +/M/Acc/S
	1.0 1.0 1.0 EcoBoost 1.0 EcoBoost 1.25 i 16V 1.25 i 16V 1.4 Duratec LPG 1.4 i 16V 1.4 TDCi 1.4 TDCi 1.5 TDCi 1.6 TDCi 1.6 TDCi 1.6 TDCi 1.6 TDCi 1.6 Ti-VCT 1.6 Ti-VCT	48 59 74 92 44 60 71 50 51 55 55 66 70 77 88 99		10.12 10.12 10.12 09.08 09.08 06.09 09.08 01.09 07.10 10.12 09.08 09.08 02.10 10.12 09.08 12.10		G2123113	258 23,0 21,0 V +C
<b>FORD FOCUS I (98-04)</b>							
	1.4 i 16V 1.6 i 16V 1.8 i 16V 1.8 TDCi 1.8 Turbo DI 2.0 i 16V ST 170			10.98 10.98 10.98 03.01 10.98 10.98 03.02	09.04 09.04 09.04 09.04 09.04 09.04 09.04	G1020505	23154 19,4 + ATE
	1.4 i 16V 1.6 i 16V 1.8 i 16V 1.8 TDCi 1.8 Turbo DI 2.0 i 16V			10.98 10.98 10.98 03.01 10.98 10.98	09.04 09.04 09.04 09.04 09.04 09.04	G2122172	258 22,0 20,0 V +C
	1.4 i 16V 1.6 i 16V 1.8 i 16V 1.8 TDCi 1.8 Turbo DI 2.0 i 16V RS 2.0 ST 170			10.98 10.98 10.98 03.01 10.98 10.98 10.02 03.02	09.04 09.04 09.04 09.04 09.04 09.04 09.04 09.04	G1020507	23353 14,6 /WD/S LUC
	1.4 i 16V 1.6 i 16V 1.8 i 16V 1.8 TDCi 1.8 Turbo DI 2.0 i 16V			10.98 10.98 10.98 03.01 10.98 10.98	09.04 09.04 09.04 09.04 09.04 09.04	G2110115	253 10,2 8,9 +C
<b>FORD FOCUS II (05-11)</b>							
	1.4 i 16V 1.6 i 16V 1.6 TDCi 1.6 TDCi 1.6 Ti VCT 1.8 i 16V 1.8 TDCi 2.0 i 16V 2.0 TDCi 2.0 TDCi 2.5 ST	59 74 66 85 92 85 107 81 166		10.04 10.04 10.04 01.05 10.04 01.06 01.05 10.04 10.04 02.08 10.05	02.11 02.11 02.11 02.11 02.11 02.11 02.11 02.11 02.11 02.11 02.11	G1020622	23723 18,1 + ATE
	1.4 i 16V 1.6 i 16V 1.6 TDCi 1.6 TDCi 1.6 Ti VCT	59 74 66 85		10.04 10.04 10.04 01.05 10.04	02.11 02.11 02.11 02.11 02.11	G2125117	278 25,0 23,0 V L +C



**FORD FOCUS II (05-11)**

	1.8 i 16V	92		01.06	02.11		G2125117		278 25,0 23,0 V L +C
	1.8 TDCi	85		01.05	02.11		G2125162		300 25,0 23,0 V L +C
	2.0 i 16V	107		10.04	02.11				
	2.0 TDCi			10.04	02.11				
	2.0 TDCi	81		02.08	02.11				
	1.4 i 16V	59		10.04	02.11		G1020727		23482 16,6 + ATE
	1.6 i 16V	74		10.04	02.11				
	1.6 TDCi			10.04	02.11				
	1.6 TDCi	66		01.05	02.11				
	1.6 Ti VCT	85		10.04	02.11				
	1.8 i 16V	92		01.06	02.11				
	1.8 TDCi	85		01.05	02.11				
	2.0 i 16V	107		10.04	02.11				
	2.0 TDCi			10.04	02.11				
	2.0 TDCi	81		02.08	02.11				
	2.5 ST	166		10.05	02.11				
	2.5 RS	224		01.09	02.11		G1020786		24537 16,1 /Acc/S LUC
	2.5 RS 500	257		05.10	02.11				
	1.4 i 16V	59		10.04	02.11		G2111155		265 11,0 9,0 +C
	1.6 i 16V	74		10.04	02.11				
	1.6 TDCi			10.04	02.11				
	1.6 TDCi	66		01.05	02.11				
	1.6 Ti VCT	85		10.04	02.11				
	1.8 i 16V	92		01.06	02.11				
	1.8 TDCi	85		01.05	02.11		G2111158		280 11,0 9,0 +S +C
	2.0 i 16V	107		10.04	02.11				
	2.0 TDCi			10.04	02.11				
	2.0 TDCi	81		02.08	02.11				
	2.5 ST	166		10.05	02.11				
	2.5 RS	224		01.09	02.11		G2111145		302 10,9 9,0 +C
	2.5 RS 500	257		05.10	02.11				

**FORD FOCUS III (11-)**

	1.0 EcoBoost	74		02.12			G1020622		23723 18,1 + ATE
	1.0 EcoBoost	92		02.12					
	1.6 EcoBoost	110		03.11					
	1.6 EcoBoost	134		03.11					
	1.6 Flexifuel	110		07.13					
	1.6 LPG	88		02.12					
	1.6 TDCi	70		03.11					
	1.6 TDCi	85		03.11					
	1.6 TDCi ECOnetic	77		04.12					
	1.6 Ti-VCT	63		08.11					
	1.6 Ti-VCT	77		03.11					
	1.6 Ti-VCT	92		03.11					
	1.6 Ti-VCT Flexifuel	88		03.11					
	2.0 TDCi	85		03.11					
	2.0 TDCi	100		03.11					
	2.0 TDCi	103		03.11					
	2.0 TDCi	120		03.11					
	1.6 EcoBoost	110		03.11			G2125162		300 25,0 23,0 V L +C
	1.6 EcoBoost	134		03.11					
	1.6 Flexifuel	110		07.13					
	2.0 TDCi	85		03.11					
	2.0 TDCi	100		03.11					
	2.0 TDCi	103		03.11					
	2.0 TDCi	120		03.11					
	1.0 EcoBoost	74		02.12			G2125199		278 25,0 23,0 V L +C
	1.0 EcoBoost	92		02.12					
	1.6 LPG	88		02.12					
	1.6 TDCi	70		03.11					
	1.6 TDCi	85		03.11					
	1.6 TDCi ECOnetic	77		04.12					
	1.6 Ti-VCT	63		08.11					
	1.6 Ti-VCT	77		03.11					
	1.6 Ti-VCT	92		03.11					
	1.6 Ti-VCT Flexifuel	88		03.11					
	1.0 EcoBoost	74		02.12			G1020727		23482 16,6 + ATE
	1.0 EcoBoost	92		02.12					
	1.6 EcoBoost	110		03.11					
	1.6 EcoBoost	134		03.11					
	1.6 Flexifuel	110		07.13					
	1.6 LPG	88		02.12					
	1.6 TDCi	70		03.11					
	1.6 TDCi	85		03.11					
	1.6 TDCi ECOnetic	77		04.12					
	1.6 Ti-VCT	63		08.11					
	1.6 Ti-VCT	77		03.11					
	1.6 Ti-VCT	92		03.11					
	1.6 Ti-VCT Flexifuel	88		03.11					
	2.0 EcoBoost ST	184		06.12					
	2.0 TDCi	85		03.11					
	2.0 TDCi	100		03.11					
	2.0 TDCi	103		03.11					
	2.0 TDCi	120		03.11					



### FORD FOCUS C-MAX (03-07)

	1.6 i 16V	74		08.03	03.07	G1020622		23723 18,1 +	ATE
	1.6 TDCi	66		01.05	03.07				
	1.6 TDCi	80		08.03	03.07				
	1.6 Ti VCT	85		08.04	03.07				
	1.8 i 16V	88		08.03	03.07				
	1.8 i 16V	92		04.04	03.07				
	1.8 TDCi	85		01.05	03.07				
	2.0 i 16V	107		04.04	03.07				
	2.0 TDCi	100		08.03	03.07				
	1.6 i 16V	74		08.03	03.07	G2125117 G2125162	+ 15"/16" wheel <sup>1)</sup> + 17" wheel <sup>2)</sup>	278 25,0 23,0 V L + C 300 25,0 23,0 V L + C	
	1.6 TDCi	66		01.05	03.07				
	1.6 TDCi	80		08.03	03.07				
	1.6 Ti VCT	85		08.04	03.07				
	1.8 i 16V	88		08.03	03.07				
	1.8 i 16V	92		04.04	03.07				
	1.8 TDCi	85		01.05	03.07				
	2.0 i 16V	107		04.04	03.07				
	2.0 TDCi	100		08.03	03.07				
	1.6 i 16V	74		08.03	03.07	G1020727		23482 16,6 +	ATE
	1.6 TDCi	66		01.05	03.07				
	1.6 TDCi	80		08.03	03.07				
	1.6 Ti VCT	85		08.04	03.07				
	1.8 i 16V	88		08.03	03.07				
	1.8 i 16V	92		04.04	03.07				
	1.8 TDCi	85		01.05	03.07				
	2.0 i 16V	107		04.04	03.07				
	2.0 TDCi	100		08.03	03.07				
	1.6 i 16V	74		08.03	03.07	G211155		265 11,0 9,0 + C	
	1.6 TDCi	66		01.05	03.07				
	1.6 TDCi	80		08.03	03.07				
	1.6 Ti VCT	85		08.04	03.07				
	1.8 i 16V	88		08.03	03.07				
	1.8 i 16V	92		04.04	03.07				
	1.8 TDCi	85		01.05	03.07	G211158		280 11,0 9,0 + S + C	
	2.0 i 16V	107		04.04	03.07				
	2.0 TDCi	100		08.03	03.07				

### FORD FUSION (02-12)



















	1.25 i 16V	55		08.04	09.12	G1020519		23604 17,8 +	ATE
	1.4 i 16V	59		07.02	09.12				
	1.4 TDCi	50		07.02	09.12				
	1.6 i 16V	74		07.02	09.12				
	1.6 TDCi	66		10.04	09.12				
	1.25 i 16V	55		08.04	09.12	G2122172		258 22,0 20,0 V + C	
	1.4 i 16V	59		07.02	09.12				
	1.4 TDCi	50		07.02	09.12				
	1.6 i 16V	74		07.02	09.12				
	1.6 TDCi	66		10.04	09.12				

### FORD GALAXY I (95-06)

	1.9 TDI	66		01.96	03.00	G1020312		21624 20,3 +	ATE				
	1.9 TDI	81		10.97	03.00								
	2.0 i			09.95	04.01								
	2.3 i 16V			01.97	04.01								
	2.8 i V6	128		09.95	03.00								
	1.9 TDI	66		04.00	04.01	G1020557		21849 19,8 +/Wl	ATE				
	1.9 TDI	85		04.00	04.01								
	1.9 TDI	66		05.01	04.06								
	1.9 TDI	85		05.01	04.06								
	1.9 TDI	96		02.03	04.06								
	1.9 TDI	110		05.05	04.06								
	2.8 i V6	150		04.00	04.06	G1020580		23269 19,8 +/Wl	ATE				
	1.9 TDI	66		01.96	04.01					G2125114		288 25,1 21,0 V L + S + C	
	1.9 TDI	81		10.97	03.00								
	1.9 TDI	85		04.00	04.01								
	2.0 i			09.95	04.01								
2.3 i 16V			01.97	04.01									
2.8 i V6	128		09.95	03.00									
	1.9 TDI	66		01.96	03.00	G1020549		20961 17,1 /WD/S	LUC				
	1.9 TDI	81		10.97	03.00								
	2.0 i			09.95	04.06								
	2.3 i 16V			01.97	04.06								
	2.8 i V6	128		09.95	03.00								
	1.9 TDI	66		04.00	04.06	G1020564		20961 16,8 +/Wl/Acc/S	LUC				
	1.9 TDI	85		04.00	04.06								
	1.9 TDI	96		02.03	04.06								
	1.9 TDI	110		05.05	04.06								
	2.8 i V6	150		04.00	04.06								
	1.9 TDI	66		01.96	04.06	G2110223		268 10,0 8,0 + S + C					
	1.9 TDI	81		10.97	03.00								
	1.9 TDI	85		04.00	04.06								
	1.9 TDI	96		02.03	04.06								
	1.9 TDI	110		05.05	04.06								
	2.0 i			09.95	04.06								
2.3 i 16V			01.97	04.06									























<sup>1)</sup> + ruota 15"/16" / + roue 15"/16" / + rueda 15"/16" / + 15"/16" Rad

<sup>2)</sup> + ruota 17" / + roue 17" / + rueda 17" / + 17" Rad

								
<b>FORD GALAXY I (95-06)</b>								
	2.8 i V6	128		09.95	03.00		G2110223	268 10,0 8,0 +S +C
<b>FORD GALAXY II (06-)</b>								
	1.6 EcoBoost	118		02.11			G1020889	24123 20,3 + ATE
	1.6 TDCi	85		02.11				
	1.8 TDCi	74		04.06				
	1.8 TDCi	92		04.06				
	2.0 Flexifuel	107		05.06				
	2.0 i 16V	107		04.06				
	2.0 TDCi	85		10.07				
	2.0 TDCi	96		04.06				
	2.0 TDCi	100		05.06				
	2.0 TDCi	103		04.06				
	2.0 TDCi	120		03.10				
	2.2 TDCi	129		11.08				
	2.2 TDCi	147		07.10				
	2.3 i 16V	118		07.07				
	2.0 SCTi EcoBoost	149		03.10			G1201009	24142 20,6 + ATE
	2.2 TDCi	129		04.08	10.08			
	1.6 EcoBoost	118		02.11			G2128154	300 28,0 26,0 V L +S +C
	1.6 TDCi	85		02.11				
	1.8 TDCi	74		04.06				
	1.8 TDCi	92		04.06				
	2.0 Flexifuel	107		05.06				
	2.0 i 16V	107		04.06				
	2.0 TDCi	85		10.07				
	2.0 TDCi	96		04.06				
	2.0 TDCi	100		05.06				
	2.0 TDCi	103		04.06				
	2.0 TDCi	120		03.10				
	2.2 TDCi	129		11.08				
	2.2 TDCi	147		07.10				
	2.3 i 16V	118		07.07				
	1.6 EcoBoost	118		02.11			G1020786	+ mechanical parking brake <sup>1)</sup>
	1.6 TDCi	85		02.11			G1020787	+ electric parking brake <sup>2)</sup>
	1.8 TDCi	74		04.06				24537 16,1 /Acc/S
	1.8 TDCi	92		04.06				24496 17,3 /Acc/S
	2.0 Flexifuel	107		05.06				
	2.0 i 16V	107		04.06				
	2.0 SCTi EcoBoost	149		03.10				
	2.0 TDCi	85		10.07				
	2.0 TDCi	96		04.06				
	2.0 TDCi	100		05.06				
	2.0 TDCi	103		04.06				
	2.0 TDCi	120		03.10				
	2.2 TDCi	129		04.08				
	2.2 TDCi	147		07.10				
	2.3 i 16V	118		07.07				
	1.6 EcoBoost	118		02.11			G2111145	302 10,9 9,0 +C
	1.6 TDCi	85		02.11				
	1.8 TDCi	74		04.06				
	1.8 TDCi	92		04.06				
	2.0 Flexifuel	107		05.06				
	2.0 i 16V	107		04.06				
	2.0 SCTi EcoBoost	149		03.10				
	2.0 TDCi	85		10.07				
	2.0 TDCi	96		04.06				
	2.0 TDCi	100		05.06				
	2.0 TDCi	103		04.06				
	2.0 TDCi	120		03.10				
	2.2 TDCi	129		04.08				
	2.2 TDCi	147		07.10				
	2.3 i 16V	118		07.07				
<b>FORD KA I (96-08)</b>								
	1.0 i			11.96	01.00		G1020333	21202 16,9 + ATE
	1.3 i			11.96	01.00			
	1.0 i			02.00	09.08		G1020467	23200 18,0 + ATE
	1.3 i			02.00	09.08			
	1.6 i	70		08.03	09.08		G1020519	23604 17,8 + ATE
	1.0 i			11.96	01.00		G2112141	239 12,0 10,0 +C
	1.3 i			11.96	01.00			
	1.0 i			02.00	09.08		G2120147	240 20,0 18,0 V +C
	1.3 i			02.00	09.08			
	1.6 i	70		08.03	09.08		G2122172	258 22,0 20,0 V +C
<b>FORD KA II (08-)</b>								
	1.2 i 16V	51		10.08			G1020951	21436 17,0 /WV/Acc BOS
	1.3 TDCi	55		10.08	10.10		G1020952	24072 17,9 +/WV/Acc/S BOS
	1.3 TDCi	55		10.08			G2120184	241 20,0 18,2 V +C

<sup>1)</sup> + fr. stazionamento meccanico / + frein à main mécanique / + freno de mano mecánica / + mechanische Feststellbremse

<sup>2)</sup> + freno a mano elettrico / + frein à main électrique / + freno de mano eléctrico / + elektrische Feststellbremse

								
<b>FORD KUGA I (08-12)</b>								
	2.0 TDCi 2.0 TDCi 2.0 TDCi 4x4 2.0 TDCi 4x4 2.0 TDCi 4x4 2.5 i 2.5 i 4x4	100 103 100 103 120 147 147		04.08 03.10 04.08 03.10 03.10 03.09 11.08	12.12 12.12 12.12 12.12 12.12 12.12 12.12	G1020622		23723 18,1 +       ATE
	2.0 TDCi 2.0 TDCi 2.0 TDCi 4x4 2.0 TDCi 4x4 2.0 TDCi 4x4 2.5 i 2.5 i 4x4	100 103 100 103 120 147 147		04.08 03.10 04.08 03.10 03.10 03.09 11.08	12.12 12.12 12.12 12.12 12.12 12.12 12.12	G2125162		300 25,0 23,0 V L + C
	2.0 TDCi 2.0 TDCi 2.0 TDCi 4x4 2.0 TDCi 4x4 2.0 TDCi 4x4 2.5 i 2.5 i 4x4	100 103 100 103 120 147 147		04.08 03.10 04.08 03.10 03.10 03.09 11.08	12.12 12.12 12.12 12.12 12.12 12.12 12.12	G1020786		24537 16,1 /Acc/S       LUC
	2.0 TDCi 2.0 TDCi 2.0 TDCi 4x4 2.0 TDCi 4x4 2.0 TDCi 4x4 2.5 i 2.5 i 4x4	100 103 100 103 120 147 147		04.08 03.10 04.08 03.10 03.10 03.09 11.08	12.12 12.12 12.12 12.12 12.12 12.12 12.12	G2111145		302 10,9 9,0 + C
<b>FORD KUGA II (13-)</b>								
	1.6 EcoBoost 1.6 EcoBoost 4x4 2.0 TDCi 2.0 TDCi	110 134 103 120		01.13 01.13 01.13 01.13		G1020727		23482 16,6 +    ATE
<b>FORD MAVERICK (01-07)</b>								
	2.0 i 16V 2.3 i 16V 3.0 i 24V 3.0 i V6	91 110 149 145		02.01 03.04 03.04 02.01	06.07 + RA disc brake <sup>1)</sup> 06.07 + RA disc brake <sup>1)</sup> 06.07 + RA disc brake <sup>1)</sup> 06.07 + RA disc brake <sup>1)</sup>	G1205352		24438 16,1 +    ATE
<b>FORD MONDEO I (93-96)</b>								
	1.6 i 16V 1.8 i 16V 1.8 TD 2.0 i 16V			01.93 01.93 01.93 01.93	09.96 09.96 09.96 09.96	G1020320 G1020265		21394 17,5 + 21396 17,5 +/Wl   ATE ATE
	1.6 i 16V 1.8 i 16V 1.8 TD 2.0 i 16V			01.93 01.93 01.93 01.93	09.96 09.96 09.96 09.96	G2124120		260 24,0 22,2 V + C
	1.8 i 16V 1.8 TD 2.0 i 16V 2.5 i 24V			01.93 01.93 01.93 08.94	09.96 09.96 09.96 09.96	G1020885 G1020886	- Ghia model <sup>2)</sup> + Ghia model <sup>3)</sup>	21586 15,0 23410 15,0 +/Wl   BDX BDX
	1.8 i 16V 1.8 TD 2.0 i 16V 2.5 i 24V			01.93 01.93 01.93 08.94	09.96 09.96 09.96 09.96	G2120146		253 20,0 18,0 V + C
<b>FORD MONDEO II (96-00)</b>								
	1.6 i 16V 1.8 i 16V 1.8 TD 2.0 i 16V 2.5 i 24V 2.5 ST 200			10.96 10.96 10.96 10.96 12.97 05.99	09.00 09.00 09.00 09.00 09.00 09.00	G1020320 G1020265		21394 17,5 + 21396 17,5 +/Wl     ATE ATE
	1.6 i 16V 1.8 i 16V 1.8 TD 2.0 i 16V			10.96 10.96 10.96 10.96	09.00 09.00 09.00 09.00	G2124120		260 24,0 22,2 V + C
	1.6 i 16V 1.8 i 16V 1.8 TD 2.0 i 16V 2.5 i 24V 2.5 ST 200			10.96 10.96 10.96 10.96 10.96 05.99	09.00 09.00 09.00 09.00 09.00 09.00	G1020885 G1020886	- Ghia model <sup>2)</sup> + Ghia model <sup>3)</sup>	21586 15,0 23410 15,0 +/Wl     BDX BDX
	1.6 i 16V 1.8 i 16V 1.8 TD 2.0 i 16V 2.5 i 24V 2.5 ST 200			10.96 10.96 10.96 10.96 10.96 05.99	09.00 09.00 09.00 09.00 09.00 09.00	G2120146		253 20,0 18,0 V + C

<sup>1)</sup> + P disco freno / + frein à disque essieu AR / + ET-disco de freno / + HA-Scheibenbremse

















<sup>2)</sup> - modello Ghia / - modèles Ghia / - modelo Ghia / - Ghia Modelle

<sup>3)</sup> + modello Ghia / + modèles Ghia / + modelo Ghia / + Ghia Modelle



















FORD MONDEO III (00-07)										
	1.8 i 16V 1.8 SCi 2.0 DI 2.0 i 16V 2.0 TDCi 2.2 TDCi 2.5 i V6 3.0 i V6 ST 220			10.00 06.03 10.00 10.00 10.01 09.04 10.00 09.04 04.02	03.07 03.07 03.07 03.07 03.07 03.07 03.07 03.07 03.07			G1020562	23279 18,4 /S	BOS
	1.8 i 16V 1.8 SCi 2.0 DI 2.0 i 16V 2.0 TDCi 2.2 TDCi 2.5 i V6 3.0 i V6 ST 220			10.00 06.03 10.00 10.00 10.01 09.04 10.00 09.04 04.02	03.07 03.07 03.07 03.07 03.07 03.07 03.07 03.07 03.07			G2124161	300 23,9 22,0 V +C	
	1.8 i 16V 1.8 SCi 2.0 DI 2.0 i 16V 2.0 TDCi 2.2 TDCi 2.5 i V6 ST 220			10.00 06.03 10.00 10.00 10.01 09.04 10.00 09.04 04.02	08.04 08.04 08.04 08.04 08.04 08.04 08.04 08.04 08.04			G1020563	23557 17,2 /S	BOS
	1.8 i 16V 1.8 SCi 2.0 DI 2.0 i 16V 2.0 TDCi 2.2 TDCi 2.5 i V6 3.0 i V6 ST 220			09.04 09.04 09.04 09.04 09.04 09.04 09.04 09.04 09.04	03.07 03.07 03.07 03.07 03.07 03.07 03.07 03.07 03.07			G1020625	24260 16,4 /Acc/S	BOS
	1.8 i 16V 1.8 SCi 2.0 DI 2.0 i 16V 2.0 TDCi 2.2 TDCi 2.5 i V6 3.0 i V6 ST 220			10.00 06.03 10.00 10.00 10.01 09.04 10.00 09.04 04.02	03.07 03.07 03.07 03.07 03.07 03.07 03.07 03.07 03.07			G2112154	280 12,0 10,0 +C	

FORD MONDEO IV (07-)											
	1.6 EcoBoost 1.6 TDCi 1.6 Ti VCT 1.6 Ti VCT 1.6 Ti VCT 1.8 TDCi 1.8 TDCi 2.0 EcoBoost 2.0 Flexifuel 2.0 i 16V 2.0 LPG 2.0 SCTi 2.0 TDCi 2.0 TDCi 2.0 TDCi 2.0 TDCi 2.0 TDCi 2.0 TDCi 2.2 TDCi 2.2 TDCi 2.3 i 16V 2.5 i 20V	118 85 81 88 92 74 92 176 107 107 107 149 85 96 100 103 120 129 147 118 162		02.11 02.11 04.07 07.10 04.07 04.07 06.07 07.10 03.07 04.07 07.09 03.10 10.07 04.07 03.09 04.07 03.10 04.08 11.10 07.07 04.07					G1020889	24123 20,3 +	ATE
	1.6 EcoBoost 1.6 TDCi 1.6 Ti VCT 1.6 Ti VCT 1.6 Ti VCT 1.8 TDCi 1.8 TDCi 2.0 EcoBoost 2.0 Flexifuel 2.0 i 16V 2.0 LPG 2.0 SCTi 2.0 TDCi 2.0 TDCi 2.0 TDCi 2.0 TDCi 2.0 TDCi 2.0 TDCi 2.2 TDCi 2.2 TDCi 2.3 i 16V 2.5 i 20V	118 85 81 88 92 74 92 176 107 107 107 149 85 96 100 103 120 129 147 118 162		02.11 02.11 04.07 07.10 04.07 04.07 06.07 07.10 03.07 04.07 07.09 03.10 10.07 04.07 03.09 04.07 03.10 04.08 11.10 07.07 04.07				G1020786	24537 16,1 /Acc/S	LUC	

							
<b>FORD MONDEO IV (07-)</b>							
	1.6 EcoBoost	118		02.11		G2111145	302 10,9 9,0 +C
	1.6 TDCi	85		02.11			
	1.6 Ti VCT	81		04.07			
	1.6 Ti VCT	88		07.10			
	1.6 Ti VCT	92		04.07			
	1.8 TDCi	74		04.07			
	1.8 TDCi	92		06.07			
	2.0 EcoBoost	176		07.10			
	2.0 Flexifuel	107		03.07			
	2.0 i 16V	107		04.07			
	2.0 LPG	107		07.09			
	2.0 SCTi	149		03.10			
	2.0 TDCi	85		10.07			
	2.0 TDCi	96		04.07			
	2.0 TDCi	100		03.09			
	2.0 TDCi	103		04.07			
	2.0 TDCi	120		03.10			
	2.2 TDCi	129		04.08			
	2.2 TDCi	147		11.10			
	2.3 i 16V	118		07.07			
	2.5 i 20V	162		04.07			
<b>FORD PUMA (97-01)</b>							
	1.4 i 16V			02.98	01.00	G1020334	20640 17,5 + ATE
	1.7 i 16V			06.97	01.00		
	ST 160			06.99	01.00		
	1.4 i 16V			02.00	10.00	G1020519	23604 17,8 + ATE
	1.6 i 16V			08.00	12.01		
	1.7 i 16V			02.00	12.01		
	ST 160			02.00	12.01		
	1.4 i 16V			02.98	01.00	G2120147	240 20,0 18,0 V +C
	1.7 i 16V			06.97	01.00		
	ST 160			06.99	01.00		
	1.4 i 16V			02.00	10.00	G2122172	258 22,0 20,0 V +C
	1.6 i 16V			08.00	12.01		
	1.7 i 16V			02.00	12.01		
	ST 160			02.00	12.01		
<b>FORD SCORPIO / GRANADA (GB) (95-98)</b>							
	2.0 i			10.94	08.98	G1020320	21394 17,5 + ATE
	2.3 i 16V			05.96	08.98		
	2.5 TD			10.94	08.98		
	2.9 i			01.95	08.98		
	2.0 i			10.94	08.98	G2124120	260 24,0 22,2 V +C
	2.3 i 16V			05.96	08.98		
	2.5 TD			10.94	08.98		
	2.9 i			01.95	08.98		
	2.0 i			10.94	08.98	G1020028	20981 13,8 /S LUC
	2.3 i 16V			05.96	08.98		
	2.5 TD			10.94	08.98		
	2.9 i			01.95	08.98		
	2.9 i 24V			10.94	08.98		
	2.0 i Saloon			10.94	08.98	G2110115	253 10,2 8,9 +C
	2.3 i 16V Saloon			05.96	08.98		
	2.5 TD Saloon			10.94	08.98		
	2.9 i Saloon			01.95	08.98		
	2.0 i Estate			10.94	08.98	G2120146	253 20,0 18,0 V +C
	2.3 i 16V Estate			05.96	08.98		
	2.5 TD Estate			10.94	08.98		
	2.9 i Estate			01.95	08.98		
<b>FORD S-MAX (06-)</b>							
	1.6 EcoBoost	118		02.11		G1020889	24123 20,3 + ATE
	1.6 TDCi	85		02.11			
	1.8 TDCi	74		01.07			
	1.8 TDCi	92		04.06			
	2.0 i 16V	107		04.06			
	2.0 TDCi	85		10.07			
	2.0 TDCi	96		04.06			
	2.0 TDCi	100		05.06			
	2.0 TDCi	103		04.06			
	2.0 TDCi	120		03.10			
	2.2 TDCi	129		11.08			
	2.2 TDCi	147		07.10			
	2.3 i 16V	118		07.07			
	2.0 EcoBoost	176		07.10		G1201009	24142 20,6 + ATE
	2.0 SCTi EcoBoost	149		03.10			
	2.2 TDCi	129	10.08	04.08			
	2.5 ST	162		04.06			
	1.6 EcoBoost	118		02.11		G2128154	300 28,0 26,0 V L +S +C
	1.6 TDCi	85		02.11			
	1.8 TDCi	74		01.07			
	1.8 TDCi	92		04.06			
	2.0 EcoBoost	176		05.11			
	2.0 i 16V	107		04.06			
	2.0 TDCi	85		10.07			



							
<b>FORD S-MAX (06-)</b>							
	2.0 TDCi	96		04.06		G2128154	300 28,0 26,0 V L +S +C
	2.0 TDCi	100		05.06			
	2.0 TDCi	103		04.06			
	2.0 TDCi	120		03.10			
	2.2 TDCi	129		11.08			
	2.2 TDCi	147		07.10			
	2.3 i 16V	118		07.07			
	1.6 EcoBoost	118		02.11		G1020786	+ mechanical parking brake <sup>1)</sup>
	1.6 TDCi	85		02.11		G1020787	+ electric parking brake <sup>2)</sup>
	1.8 TDCi	74		01.07			24537 16,1 /Acc/S
	1.8 TDCi	92		04.06			24496 17,3 /Acc/S
	2.0 EcoBoost	176		07.10			
	2.0 i 16V	107		04.06			
	2.0 SCTi EcoBoost	149		03.10			
	2.0 TDCi	85		10.07			
	2.0 TDCi	96		04.06			
	2.0 TDCi	100		05.06			
	2.0 TDCi	103		04.06			
	2.0 TDCi	120		03.10			
	2.2 TDCi	129		04.08			
	2.2 TDCi	147		07.10			
	2.3 i 16V	118		07.07			
	2.5 ST	162		04.06			
	1.6 EcoBoost	118		02.11		G2111145	302 10,9 9,0 +C
	1.6 TDCi	85		02.11			
	1.8 TDCi	74		01.07			
	1.8 TDCi	92		04.06			
	2.0 EcoBoost	176		07.10			
	2.0 i 16V	107		04.06			
	2.0 SCTi EcoBoost	149		03.10			
	2.0 TDCi	85		10.07			
	2.0 TDCi	96		04.06			
	2.0 TDCi	100		05.06			
	2.0 TDCi	103		04.06			
	2.0 TDCi	120		03.10			
	2.2 TDCi	129		04.08			
	2.2 TDCi	147		07.10			
	2.3 i 16V	118		07.07			
	2.5 ST	162		04.06			
<b>FORD STREET KA (03-06)</b>							
	1.6 i	70		02.03	02.06	G1020519	23604 17,8 +
							ATE
	1.6 i	70		02.03	02.06	G2122172	258 22,0 20,0 V +C
<b>FORD TOURNEO (94-00)</b>							
	2.0			07.94	03.00 + 14" wheel <sup>3)</sup>	G1020617	21470 18,0 /WD
	2.5 D			07.94	03.00 + 14" wheel <sup>3)</sup>		BDX
	2.5 TD			07.94	03.00 + 14" wheel <sup>3)</sup>		
	2.0			07.94	03.00 + 15" wheel <sup>4)</sup>	G1020618	21469 18,0 /WD
	2.5 D			07.94	03.00 + 15" wheel <sup>4)</sup>		BDX
	2.5 TD			07.94	03.00 + 15" wheel <sup>4)</sup>		
	2.0			07.94	03.00 + 14" wheel <sup>3)</sup>	G2124131	254 24,2 22,2 V +C
	2.5 D			07.94	03.00 + 14" wheel <sup>3)</sup>		
	2.5 TD			07.94	03.00 + 14" wheel <sup>3)</sup>		
<b>FORD TRANSIT (92-94)</b>							
	2.0 Bus	66		09.91	09.94	G1020617	+ 14" wheel <sup>3)</sup>
	2.0 i Bus	72		09.91	07.94		21470 18,0 /WD
	2.0 i Kasten	72		09.91	06.94		BDX
	2.0 Kasten	66		09.91	06.94		
	2.0 Pritsche/Fahrg.	72		09.91	08.94		
	2.5 DI Bus	51		08.91	07.94		
	2.5 DI Bus	59		09.91	07.94		
	2.5 DI Kasten	51		05.91	06.94		
	2.5 DI Kasten	59		05.91	06.94		
	2.5 DI Kasten	63		10.92	06.94		
	2.5 DI Prits./Fahrg.	51		09.91	08.94		
	2.5 DI Prits./Fahrg.	59		09.91	08.94		
	2.5 TD Bus	63		10.92	07.94		
	2.5 TD Bus	74		09.91	07.94		
	2.5 TD Kasten	74		05.91	06.94		
	2.5 TD Prits./Fahrg.	63		11.92	08.94		
	2.5 TD Prits./Fahrg.	74		09.91	08.94		
	2.9 i Bus	107		01.91	08.94		
	2.0 Bus	66		09.91	09.94	G1020618	+ 15" wheel <sup>4)</sup>
	2.0 i Bus	72		09.91	07.94		21469 18,0 /WD
	2.0 i Kasten	72		09.91	06.94		BDX
	2.0 Kasten	66		09.91	06.94		
	2.0 Pritsche/Fahrg.	72		09.91	08.94		
	2.5 DI Bus	51		08.91	07.94		
	2.5 DI Bus	59		09.91	07.94		
	2.5 DI Kasten	51		05.91	06.94		

<sup>1)</sup> + fr. stazionamento meccanico / + frein à main mécanique / + freno de mano mecánica / + mechanische Feststellbremse

<sup>2)</sup> + freno a mano elettrico / + frein à main électrique / + freno de mano eléctrico / + elektrische Feststellbremse

<sup>3)</sup> + ruota 14" / + roue 14" / + rueda 14" / + 14" Rad

<sup>4)</sup> + ruota 15" / + roue 15" / + rueda 15" / + 15" Rad







FORD TRANSIT (92-94)									
	2.5 DI Kasten	59		05.91	06.94	G1020618	+ 15" wheel <sup>1)</sup>	21469 18,0 /WD	BDX
	2.5 DI Kasten	63		10.92	06.94				
	2.5 DI Prits./Fahrg.	51		09.91	08.94				
	2.5 DI Prits./Fahrg.	59		09.91	08.94				
	2.5 TD Bus	63		10.92	07.94				
	2.5 TD Bus	74		09.91	07.94				
	2.5 TD Kasten	74		05.91	06.94				
	2.5 TD Prits./Fahrg.	63		11.92	08.94				
	2.5 TD Prits./Fahrg.	74		09.91	08.94				
	2.9 i Bus	107		01.91	08.94				
	2.0 Bus	66		09.91	09.94	G2124131	+ 14" wheel <sup>2)</sup>	254 24,2 22,2 V +C	
	2.0 i Bus	72		09.91	07.94				
	2.0 i Kasten	72		09.91	06.94				
	2.0 Kasten	66		09.91	06.94				
	2.0 Pritsche/Fahrg.	72		09.91	08.94				
	2.5 DI Bus	51		08.91	07.94				
	2.5 DI Bus	59		09.91	07.94				
	2.5 DI Kasten	51		05.91	06.94				
	2.5 DI Kasten	59		05.91	06.94				
	2.5 DI Kasten	63		10.92	06.94				
	2.5 DI Prits./Fahrg.	51		09.91	08.94				
	2.5 DI Prits./Fahrg.	59		09.91	08.94				
	2.5 TD Bus	63		10.92	07.94				
	2.5 TD Bus	74		09.91	07.94				
	2.5 TD Kasten	74		05.91	06.94				
	2.5 TD Prits./Fahrg.	63		11.92	08.94				
	2.5 TD Prits./Fahrg.	74		09.91	08.94				
	2.9 i Bus	107		01.91	08.94				

FORD TRANSIT (95-00)									
	2.0 Bus	84		09.95	03.00	G1020617	+ 14" wheel <sup>2)</sup>	21470 18,0 /WD	BDX
	2.0 CNG Bus	84		06.94	03.00				
	2.0 Kasten	84		06.94	03.00				
	2.0 Pritsche/Fahrg.	84		08.94	03.00				
	2.5 DI Bus	51		08.94	03.00				
	2.5 DI Bus	56		07.94	03.00				
	2.5 DI Bus	85		08.97	03.00				
	2.5 DI Kasten	51		06.94	03.00				
	2.5 DI Kasten	56		06.94	03.00				
	2.5 DI Kasten	85		05.99	03.00				
	2.5 DI Prits./Fahrg.	51		08.94	03.00				
	2.5 DI Prits./Fahrg.	56		08.94	03.00				
	2.5 DI Prits./Fahrg.	85		05.99	03.00				
	2.5 TD Bus	55		08.94	03.00				
	2.5 TD Bus	63		01.95	03.00				
	2.5 TD Bus	74		07.94	03.00				
	2.5 TD Kasten	55		10.98	03.00				
	2.5 TD Kasten	63		06.94	03.00				
	2.5 TD Kasten	74		06.94	03.00				
	2.5 TD Prits./Fahrg.	55		10.98	03.00				
2.5 TD Prits./Fahrg.	63		08.94	03.00					
2.5 TD Prits./Fahrg.	74		08.94	03.00					
	2.0 Bus	84		09.95	03.00	G1020618	+ 15" wheel <sup>1)</sup>	21469 18,0 /WD	BDX
	2.0 CNG Bus	84		06.94	03.00				
	2.0 Kasten	84		06.94	03.00				
	2.0 Pritsche/Fahrg.	84		08.94	03.00				
	2.5 DI Bus	51		08.94	03.00				
	2.5 DI Bus	56		07.94	03.00				
	2.5 DI Bus	85		08.97	03.00				
	2.5 DI Kasten	51		06.94	03.00				
	2.5 DI Kasten	56		06.94	03.00				
	2.5 DI Kasten	85		05.99	03.00				
	2.5 DI Prits./Fahrg.	51		08.94	03.00				
	2.5 DI Prits./Fahrg.	56		08.94	03.00				
	2.5 DI Prits./Fahrg.	85		05.99	03.00				
	2.5 TD Bus	55		08.94	03.00				
	2.5 TD Bus	63		01.95	03.00				
	2.5 TD Bus	74		07.94	03.00				
	2.5 TD Kasten	55		10.98	03.00				
	2.5 TD Kasten	63		06.94	03.00				
	2.5 TD Kasten	74		06.94	03.00				
	2.5 TD Prits./Fahrg.	55		10.98	03.00				
2.5 TD Prits./Fahrg.	63		08.94	03.00					
2.5 TD Prits./Fahrg.	74		08.94	03.00					
	2.0 Bus	84		09.95	03.00	G2124131	+ 14" wheel <sup>2)</sup>	254 24,2 22,2 V +C	
	2.0 CNG Bus	84		06.94	03.00				
	2.0 Kasten	84		06.94	03.00				
	2.0 Pritsche/Fahrg.	84		08.94	03.00				
	2.5 DI Bus	51		08.94	03.00				
	2.5 DI Bus	56		07.94	03.00				
	2.5 DI Bus	85		08.97	03.00				
	2.5 DI Kasten	51		06.94	03.00				
	2.5 DI Kasten	56		06.94	03.00				
	2.5 DI Kasten	85		05.99	03.00				
2.5 DI Prits./Fahrg.	51		08.94	03.00					
2.5 DI Prits./Fahrg.	56		08.94	03.00					
2.5 DI Prits./Fahrg.	85		05.99	03.00					

1) + ruota 15" / + roue 15" / + rueda 15" / + 15" Rad  
 2) + ruota 14" / + roue 14" / + rueda 14" / + 14" Rad



        											
<b>FORD TRANSIT (95-00)</b>											
	2.5 TD Bus	55		08.94	03.00		G2124131		+ 14" wheel <sup>1)</sup>		254 24,2 22,2 V +C
	2.5 TD Bus	63		01.95	03.00						
	2.5 TD Bus	74		07.94	03.00						
	2.5 TD Kasten	55		10.98	03.00						
	2.5 TD Kasten	63		06.94	03.00						
	2.5 TD Kasten	74		06.94	03.00						
	2.5 TD Prits./Fahrg.	55		10.98	03.00						
	2.5 TD Prits./Fahrg.	63		08.94	03.00						
	2.5 TD Prits./Fahrg.	74		08.94	03.00						
<b>FORD TRANSIT (00-06)</b>											
	2.0 DI			08.00	04.06		G1020595				23434 18,7 +/W/S BOS
	2.0 TDCi			08.02	04.06						
	2.3 i 16V			04.01	04.06						
	2.4 DI			01.00	04.06						
	2.4 TDCi			03.04	04.06						
	2.4 TDE			11.01	04.06						
	2.3 16V RWD			08.00	04.06		G1020597				23577 18,7 +/W/S BOS
	2.4 DI RWD			01.00	04.06						
	2.4 TD Allrad	55		08.00	04.06						
	2.4 TDCi RWD	101		03.04	04.06						
	2.4 TDE RWD			11.01	04.06						
<b>FORD TRANSIT (06-)</b>											
	2.2 TDCi FWD			05.06		260/280/300 series <sup>2)</sup>	G1020800				24485 19,0 /W/Acc/S BOS
	2.2 TDCi 4x4			10.11			G1020801				24484 19,0 /W/Acc/S BOS
	2.2 TDCi FWD			05.06		330/350 series <sup>3)</sup>					
	2.2 TDCi RWD			10.11							
	2.3 16V RWD			05.06							
	2.4 TDCi 4x4			05.06							
	2.4 TDCi RWD			05.06							
	3.2 TDCi RWD			09.07							
	2.2 TDCi 4x4			10.11			G1020802				24486 17,4 /W/Acc/S BOS
	2.2 TDCi FWD			05.06							
	2.2 TDCi RWD			10.11							
	2.4 TDCi 4x4			05.06							
	2.4 TDCi RWD			05.06							
	3.2 TDCi RWD			09.07							
	2.3 16V RWD			05.06			G1020802		+ single tyre <sup>4)</sup>		24486 17,4 /W/Acc/S BOS
<b>FORD TRANSIT CONNECT / TOURNEO CONNECT (03-)</b>											
	1.8 16V	85		06.02			G1020692				23440 17,6 + ATE
	1.8 Di	55		06.02							
	1.8 TDCi	66		06.02							
	1.8 TDCi	81		08.06							
	1.8 16V	85		06.02			G1020470				23482 15,8 +/WD ATE
	1.8 Di	55		06.02			G1020670				23482 16,6 + ATE
	1.8 TDCi	66		06.02							
	1.8 TDCi	81		08.06							
	1.8 16V	85		06.02			G2111154				278 11,0 9,0 +C
	1.8 Di	55		06.02							
	1.8 TDCi	66		06.02							
	1.8 TDCi	81		08.06							
<b>HONDA ACCORD Saloon (03-08)</b>											
	2.0 16V (CL7)	114		02.03	05.08		G1020812				23720 17,5 +/W/A ATE
	2.0 16V (CL8) Allrad	114		02.03	05.08						
	2.2 i-CTDi (CN1)	103		01.04	05.08						
	2.4 16V (CL9)	140		02.03	05.08						
	2.4 16V (CM5)	113		09.06	05.08						
	2.4 VTEC (CM5)	122		04.06	07.08						
	2.4 VTEC E (CM5)	118		02.03	09.05						
<b>HONDA ACCORD Estate (03-08)</b>											
	2.0 i 16V (CM1)	114		04.03	05.08		G1020812				23720 17,5 +/W/A ATE
	2.2 CTDi (CM2)	103		01.04	05.08						
	2.4 i 16V (CM2)	140		04.03	05.08						
	2.4 VTEC E	118		09.03	09.05						
	2.4 VTEC T	147		09.03	05.08						
<b>HONDA CITY (08-)</b>											
	1.4 i VTEC	73		09.08			G1201000				21738 13,5 +/W/A
<b>HONDA CIVIC (3-door) (91-95)</b>											
	1.6 16V VTEC (EG5)	92		09.91	10.95 + ABS		G1020722				21694 16,3 +/W/A SUM
	1.6 16V VTEC (EG6)	118		09.91	10.95						
	1.6 16V VTEC (EG5)	92		09.91	10.95 + ABS		G2121105				262 21,0 19,0 V +S +C
	1.6 16V VTEC (EG6)	118		09.91	10.95						

<sup>1)</sup> + ruota 14" / + roue 14" / + rueda 14" / + 14" Rad



















<sup>2)</sup> Serie 260/280/300 / Série 260/280/300 / Serie 260/280/300 / Serie 260/280/300

<sup>3)</sup> Serie 330/350 / Série 330/350 / Serie 330/350 / Serie 330/350























<sup>4)</sup> + ruota singola / + roue simple / + cubierta simple / + Einfachbereifung



















										
<b>HONDA CIVIC (4-door) (91-95)</b>										
	1.6 16V 4WD VTEC(EH1)	92		09.91	10.95		G1020722	21694 16,3 +/Wl	SUM	
	1.6 16V VTEC (EG9)	118		09.91	10.95					
	1.6 16V VTEC (EH9)	92		09.91	10.95 + ABS					
	1.6 16V 4WD VTEC(EH1)	92		09.91	10.95		G2121105	262 21,0 19,0 V +S +C		
	1.6 16V VTEC (EG9)	118		09.91	10.95					
	1.6 16V VTEC (EH9)	92		09.91	10.95 + ABS					
<b>HONDA CIVIC (3/4-door) (95-01)</b>										
	1.4 i (EJ9)	55		01.98	01.01		G1020722	21694 16,3 +/Wl	SUM	
	1.4 i (EJ9)	66		01.98	01.01					
	1.5 VTEC (EK3)	84		11.95	01.01					
	1.6 VTEC (EK1)	83		11.95	01.01					
	1.6 VTEC (EK4)	118		11.95	01.01					
	1.4 i (EJ9)	55		11.95	10.98 + ABS		G2121105	262 21,0 19,0 V +S +C		
	1.4 i (EJ9)	66		11.95	10.98					
	1.5 VTEC (EK3)	84		11.95	01.01 + ABS					
	1.6 VTEC (EK1)	83		11.95	01.01					
	1.6 VTEC (EK4)	118		11.95	01.01					
	1.6 VTEC (EK4)	118		11.95	01.01		G1201000	21738 13,5 +/Wl		
<b>HONDA CIVIC (3-door) (01-05)</b>										
	1.4 i 16V	66		02.01	12.05		G1205344	+ sports suspension <sup>1)</sup>	23178 16,6 +/Wl	SUM
	1.6 i 16V	81		02.01	12.05					
	1.7 CTDi	74		01.02	12.05		G1205344	+ sports suspension <sup>1)</sup>	23178 16,6 +/Wl	SUM
	2.0 Type R	147		09.01	12.05		G1205344		23178 16,6 +/Wl	SUM
	1.4 i 16V	66		02.01	12.05		G2121105	262 21,0 19,0 V +S +C		
	1.6 i 16V	81		02.01	12.05					
<b>HONDA CIVIC (4-door) (01-05)</b>										
	1.4 i 16V	66		02.01	12.05		G1020722	21694 16,3 +/Wl	SUM	
	1.6 i 16V	81		02.01	12.05					
	1.4 i 16V	66		02.01	12.05		G2121105	262 21,0 19,0 V +S +C		
	1.6 i 16V	81		02.01	12.05					
<b>HONDA CIVIC (5-door) (95-96)</b>										
	1.4 i (MA8)			09.94	12.96		G2121105	262 21,0 19,0 V +S +C		
	1.5 VTEC E (MA9)			09.94	12.96					
	1.6 i (MB1)			09.94	12.96					
	1.6 VTEC (MB1)			09.94	12.96					
	1.4 i (MA8)			09.94	12.96 + ABS		G2110212	239 10,0 8,0 +S +C		
	1.5 VTEC E (MA9)			09.94	12.96 + ABS					
	1.6 i (MB1)			09.94	12.96					
	1.6 VTEC (MB1)			09.94	12.96					
<b>HONDA CIVIC (5-door) (97-01)</b>										
	1.4 i 16V (MB2)			01.97	02.01		G2121105	262 21,0 19,0 V +S +C		
	1.5 i 16V (MB3)			01.97	02.01					
	1.6 i 16V (MB4)			01.97	02.01					
	1.6 VTi			01.97	02.01					
	2.0 i TD (MB7)			01.97	02.01					
	1.4 i 16V (MB2)			01.97	12.98 + ABS		G2110212	239 10,0 8,0 +S +C		
	1.5 i 16V (MB3)			01.97	02.01 + ABS					
	1.6 i 16V (MB4)			01.97	02.01					
	1.6 VTi			01.97	02.01					
	2.0 i TD (MB7)			01.97	02.01					
<b>HONDA CIVIC (5-door) (01-05)</b>										
	1.4 i 16V (EU7)	66		02.01	12.05		G1020722	21694 16,3 +/Wl	SUM	
	1.6 VTEC (EU8)	81		02.01	12.05					
	1.4 i 16V (EU7)	66		02.01	12.05		G2121105	262 21,0 19,0 V +S +C		
	1.6 VTEC (EU8)	81		02.01	12.05					
<b>HONDA CIVIC Hatchback (FK/FN) (05-)</b>										
	1.4 i-VTEC (FK1)	61		01.06			G1201013	24087 17,4 +/Wl/Acc/S		
	1.4 i-VTEC (FK1/FN4)	73			10.08					
	1.8 i-VTEC (FK2/FN1)	103		01.06						
	2.2 CTDi (FK3/FN3)	103		01.06						
	2.0 i-VTEC (FN2)	110		12.06			G1205344	23178 16,6 +/Wl	SUM	
	2.0 Type R (FN2)	148		09.06						
	1.4 i-VTEC (FK1)	61		01.06			G1201014	24086 15,8 +/Wl/Acc/S		
	1.4 i-VTEC (FK1/FN4)	73		10.08						
	1.8 i-VTEC (FK2/FN1)	103		01.06						
	2.0 i-VTEC (FN2)	110		12.06						
	2.0 Type R (FN2)	148		09.06						
	2.2 CTDi (FK3/FN3)	103		01.06						





















<sup>1)</sup> + suspensión deportiva / + chassis de sport / + suspensión deportiva / + Sportfahrwerk

								
<b>HONDA CIVIC Notchback (FD) (05-)</b>								
	1.3 (FD3)	85		02.06		G1020722	21694 16,3 +/Wl	SUM
	1.3 Hybrid (FD3)	70		01.06				
	2.0 16V (FD2)	114		02.06		G1205344	23178 16,6 +/Wl	SUM
	2.0 16V (FD2)	114		02.06		G1201014	24086 15,8 +/Wl/Acc/S	
<b>HONDA CIVIC AERODECK (98-01)</b>								
	1.4 i 16V (MB8)	55		02.98	02.01	G2121105	262 21,0 19,0 V +S +C	
	1.4 i 16V (MB8)	66		02.98	02.01			
	1.5 VTEC (MB9)	84		02.98	02.01			
	1.6 i 16V (MC1)	85		02.98	02.01			
	2.0 TDiC (MC3)	77		02.98	02.01			
	1.4 i 16V (MB8)	55		02.98	12.98 + ABS	G2110212	239 10,0 8,0 +S +C	
	1.4 i 16V (MB8)	66		02.98	12.98 + ABS			
	2.0 TDiC (MC3)	77		02.98	02.01			
<b>HONDA CIVIC COUPE (94-95)</b>								
	1.6 VTEC (EJ1)	92		01.94	12.95	G1020722	21694 16,3 +/Wl	SUM
	1.6 VTEC (EJ1)	92		01.94	12.95	G2121105	262 21,0 19,0 V +S +C	
<b>HONDA CIVIC COUPE (96-01)</b>								
	1.6 VTEC (EJ8)	92		01.96	01.01	G1020722	21694 16,3 +/Wl	SUM
	1.6 VTEC (EM1)	118		04.99	01.01			
	1.6 VTEC (EJ8)	92		01.96	01.01	G2121105	262 21,0 19,0 V +S +C	
	1.6 VTEC (EM1)	118		04.99	01.01			
	1.6 VTEC (EM1)	118		04.99	01.01	G1201000	21738 13,5 +/Wl	
<b>HONDA CIVIC COUPE (01-04)</b>								
	1.6 i 16V (EM6)	81		02.01	10.04	G1020722	21694 16,3 +/Wl	SUM
	1.7 i 16V (EM2)	88		02.01	10.04			
	1.7 VTEC (EM2)	92		02.01	10.04			
	1.6 i 16V (EM6)	81		02.01	10.04	G2121105	262 21,0 19,0 V +S +C	
	1.7 i 16V (EM2)	88		02.01	10.04			
	1.7 VTEC (EM2)	92		02.01	10.04			
<b>HONDA CONCERTO (90-95)</b>								
	1.6 i 16V (HW)	82		01.90	01.95	G2110212	239 10,0 8,0 +S +C	
	1.6 i 16V (HW)	90		01.90	01.95			
<b>HONDA CR-V II (02-06)</b>								
	2.0 16V	110		07.02	09.06 + 16" wheel <sup>1)</sup>	G1020817	24638 20,0 +/Wl/Acc/S	
	2.0 16V	112		03.02	09.06 + 16" wheel <sup>1)</sup>			
	2.2 CTDi	103		02.05	09.06 + 16" wheel <sup>1)</sup>			
	2.4 VTEC Allrad	118		03.02	09.06 + 16" wheel <sup>1)</sup>			
	2.0 16V	110		01.05	09.06	G1020819	24635 16,9 +/Wl/Acc/S	
	2.4 VTEC Allrad	118		01.05	09.06			
<b>HONDA CR-V III (07-12)</b>								
	2.0 i-VTEC	105		11.09	09.12	G1020817	24638 20,0 +/Wl/Acc/S	
	2.0 i-VTEC	110		01.07	09.10			
	2.0 i-VTEC 4WD	110		01.07	09.10			
	2.2 CTDi 4WD	103		01.07	09.12			
	2.2 i-DTEC 4WD	110		01.07	09.12			
	2.4 i-VTEC	118		01.07	09.12			
	2.4 i-VTEC	125		04.07	09.12			
	2.4 i-VTEC	134		01.07	09.12			
	2.4 i-VTEC 4WD	118		01.07	09.12			
	2.4 i-VTEC 4WD	122		09.09	09.12			
	2.4 i-VTEC 4WD	124		09.07	09.12			
	2.4 i-VTEC 4WD	125		04.07	09.12			
	2.0 i-VTEC	105		11.09	09.12	G1020819	24635 16,9 +/Wl/Acc/S	
	2.0 i-VTEC	110		01.07	09.10			
	2.0 i-VTEC 4WD	110		01.07	09.10			
	2.2 CTDi 4WD	103		01.07	09.12			
	2.2 i-DTEC 4WD	110		01.07	09.12			
	2.4 i-VTEC	118		01.07	09.12			
	2.4 i-VTEC	125		04.07	09.12			
	2.4 i-VTEC	134		01.07	09.12			
	2.4 i-VTEC 4WD	118		01.07	09.12			
	2.4 i-VTEC 4WD	122		09.09	09.12			
	2.4 i-VTEC 4WD	124		09.07	09.12			
	2.4 i-VTEC 4WD	125		04.07	09.12			

<sup>1)</sup> + ruota 16" / + roue 16" / + rueda 16" / + 16" Rad



















								
<b>HONDA CRX (92-98)</b>								
	1.6 i 16V VTEC (EG2) 1.6 i 16V VTEC (EH6)	118 92		01.92 01.92	12.98 12.98		G1020722	21694 16,3 +/W/ SUM
	1.6 i 16V VTEC (EG2) 1.6 i 16V VTEC (EH6)	118 92		01.92 01.92	12.98 12.98		G2121105	262 21,0 19,0 V +S +C
<b>HONDA INSIGHT (09-)</b>								
	1.3 Hybrid 1.3 Hybrid	65 73		04.09 04.09			G2121105	262 21,0 19,0 V +S +C
<b>HONDA JAZZ (02-08)</b>								
	1.2 (GD5) 1.2 (GE2) 1.4 (GD1) 1.4 (GE3) 1.4 (GE3) 1.7 (GD3)	57 59 61 65 67 92		01.04 10.05 01.04 04.05 09.05 01.04	10.08 + ABS 10.08 10.08 + ABS 10.08 10.08 10.08		G1201000	21738 13,5 +/W/
<b>HONDA JAZZ (08-)</b>								
	1.2 i-VTEC 1.3 Hybrid 1.4 Flexfuel 1.4 i 16V 1.4 i 16V 1.5 Flexfuel 1.5 i 16V	66 65 74 73 74 88 88		01.09 04.11 11.08 01.09 11.08 01.09 01.09			G2121105	262 21,0 19,0 V +S +C
	1.2 i-VTEC 1.4 Flexfuel 1.4 i 16V 1.4 i 16V 1.5 Flexfuel 1.5 i 16V	66 74 73 74 88 88		07.08 11.08 07.08 11.08 07.08 07.08			G1201000	21738 13,5 +/W/
<b>HONDA S2000 (99-04)</b>								
	2.0 VTEC (AP1)	177		06.99	09.04		G1205344	23178 16,6 +/W/ SUM
<b>HYUNDAI ACCENT III (05-)</b>								
	1.4 i 16V 1.5 CRDi 1.6 i 16V	71 81 82		10.05 10.05 10.05			G1201033	24317 17,6 +/W/ Acc
	1.4 i 16V 1.5 CRDi 1.6 i 16V	71 81 82		10.05 10.05 10.05	+ ABS + ABS + ABS		G1201035	24320 15,3 +/W/ Acc
	1.4 i 16V 1.5 CRDi 1.6 i 16V	71 81 82		10.05 10.05 10.05	+ ABS + ABS + ABS		G2110312	262 10,0 8,4 +C
<b>HYUNDAI GETZ (02-09)</b>								
	1.5 CRDi 1.5 CRDi 1.5 CRDi GLS 1.5 CRDi GLS 1.6 i 16V 1.6 i 16V	60 65 75 81 77 78		03.03 08.05 07.04 08.05 09.02 08.05	04.05 + ABS 02.09 + ABS 07.05 + ABS 02.09 + ABS 07.05 + ABS 02.09 + ABS		G2110312	262 10,0 8,4 +C
<b>HYUNDAI i10 (08-)</b>								
	1.0 12V 1.1 12V 1.1 12V 1.1 12V 1.1 CRDi 1.1 LPG 1.2 12V 1.2 16V 1.2 16V	51 48 49 51 55 51 57 59 63		01.11 01.08 01.08 04.11 01.08 04.11 11.08 01.08 04.11			G1201047	24275 16,5 +/W/ Acc
	1.0 12V 1.1 12V 1.1 12V 1.1 12V 1.1 LPG 1.2 12V 1.2 16V 1.2 16V	51 48 49 51 51 57 59 63		01.11 01.08 01.08 04.11 04.11 11.08 01.08 04.11			G2118145	241 18,0 16,0 V +C
	1.0 12V 1.1 12V 1.1 12V 1.1 12V 1.1 CRDi 1.1 LPG 1.2 12V 1.2 16V 1.2 16V	51 48 49 51 55 51 57 59 63		01.11 01.08 01.08 04.11 01.08 04.11 11.08 01.08 04.11			G2110324	234 10,0 8,0 +C

        												
<b>HYUNDAI i20 (08-)</b>												
	1.2 16V	57		09.08		- ESP	G1201047				24275 16,5 +/Wl/Acc	
	1.2 16V	59		09.08		- ESP						
	1.2 16V	63		03.12		- ESP						
		1.1 CRDi	55		03.12		+ ESP	G1201033				24317 17,6 +/Wl/Acc
		1.2 16V	57		09.08		+ ESP					
		1.2 16V	59		09.08		+ ESP					
		1.2 16V	63		03.12		+ ESP					
		1.4 16V	74		09.08							
		1.4 CRDi	55		08.09							
		1.4 CRDi	66		09.08							
1.6 16V		91		12.08								
1.6 16V		93		09.08								
1.6 CRDi		85		09.08								
1.6 CRDi	94		01.09									
	1.1 CRDi	55		03.12		+ ESP	G1201035				24320 15,3 +/Wl/Acc	
	1.2 16V	57		09.08		+ ESP						
	1.2 16V	59		09.08		+ ESP						
	1.2 16V	63		03.12		+ ESP						
	1.4 16V	74		09.08								
	1.4 CRDi	55		08.09								
	1.4 CRDi	66		09.08								
	1.6 16V	91		12.08								
	1.6 16V	93		09.08								
	1.6 CRDi	85		09.08								
1.6 CRDi	94		01.09									
	1.1 CRDi	55		03.12		+ ESP	G2110312				262 10,0 8,4 +C	
	1.2 16V	57		09.08		+ ESP						
	1.2 16V	59		09.08		+ ESP						
	1.2 16V	63		03.12		+ ESP						
	1.4 16V	74		09.08								
	1.4 CRDi	55		08.09								
	1.4 CRDi	66		09.08								
	1.6 16V	91		12.08								
	1.6 16V	93		09.08								
	1.6 CRDi	85		09.08								
1.6 CRDi	94		01.09									
<b>HYUNDAI i30 (07-11)</b>												
	1.4 16V	77		10.07	10.11		G1201002				23966 17,7 +/Wl	
	1.4 16V	80		10.07	10.11							
	1.6 16V	85		10.07	10.11							
	1.6 16V	88		01.10	10.11							
	1.6 16V	90		10.07	10.11							
	1.6 16V	93		02.08	10.11							
	1.6 CRDi	66		10.07	10.11							
	1.6 CRDi	85		10.07	10.11							
	1.6 CRDi	94		02.08	10.11							
	2.0 16V	100		01.10	10.11							
	2.0 16V	105		10.07	10.11							
	2.0 CRDi	100		02.08	10.11							
	2.0 CRDi	103		10.07	10.11							
	1.4 16V	77		10.07	10.11		G2126150				280 26,0 24,4 V L +C	
	1.4 16V	80		10.07	10.11							
	1.6 CRDi	66		10.07	10.11							
	1.4 16V	77		10.07	10.11		G1201035				24320 15,3 +/Wl/Acc	
	1.4 16V	80		10.07	10.11							
	1.6 16V	85		10.07	10.11							
	1.6 16V	88		01.10	10.11							
	1.6 16V	90		10.07	10.11							
	1.6 16V	93		02.08	10.11							
	1.6 CRDi	66		10.07	10.11							
	1.6 CRDi	85		10.07	10.11							
	1.6 CRDi	94		02.08	10.11							
	2.0 16V	100		01.10	10.11							
	2.0 16V	105		10.07	10.11							
	2.0 CRDi	100		02.08	10.11							
	2.0 CRDi	103		10.07	10.11							
<b>HYUNDAI i30 CW Estate (08-12)</b>												
	1.4 16V	77		02.08	06.12		G1201002				23966 17,7 +/Wl	
	1.4 16V	80		11.09	06.12							
	1.6 16V	85		02.08	06.12							
	1.6 16V	88		01.10	06.12							
	1.6 16V	90		02.08	06.12							
	1.6 16V	93		02.08	06.12							
	1.6 CRDi	66		02.08	06.12							
	1.6 CRDi	85		02.08	06.12							
	1.6 CRDi	94		02.08	06.12							
	2.0 16V	100		01.10	06.12							
	2.0 16V	105		02.08	06.12							
	2.0 CRDi	100		01.10	06.12							
	2.0 CRDi	103		02.08	06.12							
	1.4 16V	77		02.08	06.12		G2126150				280 26,0 24,4 V L +C	
	1.4 16V	80		11.09	06.12							
	1.6 CRDi	66		02.08	06.12							



















								
<b>HYUNDAI i30 CW Estate (08-12)</b>								
	1.4 16V	77		02.08	06.12	G1201035	24320 15,3 +/W/Acc	
	1.4 16V	80		11.09	06.12			
	1.6 16V	85		02.08	06.12			
	1.6 16V	88		01.10	06.12			
	1.6 16V	90		02.08	06.12			
	1.6 16V	93		02.08	06.12			
	1.6 CRDi	66		02.08	06.12			
	1.6 CRDi	85		02.08	06.12			
	1.6 CRDi	94		02.08	06.12			
	2.0 16V	100		01.10	06.12			
	2.0 16V	105		02.08	06.12			
	2.0 CRDi	100		01.10	06.12			
	2.0 CRDi	103		02.08	06.12			
<b>HYUNDAI iX20 (10-)</b>								
	1.4 16V	66		11.10		G2126150	280 26,0 24,4 V L +C	
	1.4 16V	74		11.10				
	1.4 CRDi	57		06.11				
	1.4 CRDi	66		11.10				
	1.6 16V	92		11.10				
	1.6 CRDi	85		06.11				
	1.6 CRDi	94		06.11				
<b>HYUNDAI iX35 (10-)</b>								
	1.6 16V	99		11.10		G1201035	24320 15,3 +/W/Acc	
	1.7 CRDi	85		11.10				
	2.0 16V	110		04.10				
	2.0 16V	120		04.10				
	2.0 16V	122		04.10				
	2.0 16V Allrad	110		04.10				
	2.0 16V Allrad	120		04.10				
	2.0 CRDi	100		04.10				
	2.0 CRDi	130		01.12				
	2.0 CRDi	135		04.10				
	2.0 CRDi Allrad	100		04.10				
	2.0 CRDi Allrad	130		01.12				
	2.0 CRDi Allrad	135		04.10				
	2.0 CRDi Allrad	135		04.10				
<b>HYUNDAI SONATA (05-)</b>								
	2.0 CRDi	110		03.09		G1201035	24320 15,3 +/W/Acc	
	2.0 VVTi	121		01.08				
	2.4 VVTi	127		06.08				
	3.3 VVTi	184		01.08				
<b>HYUNDAI SONATA (09-)</b>								
	2.0 16V	110		01.09	- Europe <sup>1)</sup>	G1201035	24320 15,3 +/W/Acc	
	2.0 16V	121		01.11	- Europe <sup>1)</sup>			
	2.4 16V	128		01.09	- Europe <sup>1)</sup>			
	2.4 16V	131		01.09	- Europe <sup>1)</sup>			
	2.4 16V	133		10.12	- Europe <sup>1)</sup>			
	2.4 16V	148		01.09	- Europe <sup>1)</sup>			
	2.4 GDI	148		01.09	- Europe <sup>1)</sup>			
<b>IVECO DAILY I / GRINTA (78-99)</b>								
	35.10			01.96	04.99	G1020357	29121 20,3 /WD/S	BRE
	35.12			01.96	04.99			
	49.12			01.96	04.99			
	35.10			01.96	04.99	G1020357	29121 20,3 /WD/S	BRE
	35.12			01.96	04.99			
	49.12			01.96	04.99			
	60.12			01.96	04.99	G1020357	29121 20,3 /WD/S	BRE
	65.12			01.96	04.99			
<b>IVECO DAILY II (99-06)</b>								
	29			05.99	04.06	G1020357	29121 20,3 /WD/S	BRE
	35 C			05.99	04.06			
	35 S			05.99	04.06			
	49			05.99	04.06			
	35 C			05.99	04.06	G1020357	29121 20,3 /WD/S	BRE
	35 S			05.99	04.06			
	49			05.99	04.06			
	60 C			05.99	04.06	G1020357	29121 20,3 /WD/S	BRE
	65 C			05.99	04.06			
<b>IVECO DAILY III (06-)</b>								
	35 C			05.06		G1020828	29229 20,7 /WD/Acc	BRE
	35 S			05.06				
	35 C			05.06		G1020825	29232 21,0 /WD/Acc	BRE
	35 S			05.06				
<b>JAGUAR Type X (CF1) Saloon (01-09)</b>								
	2.0 D	96	J04730	07.03		G1020562	23279 18,4 /S	BOS
	2.0 V6	115	J04730	03.02				
	2.2 D	107	J04730	01.07				
	2.2 D	110	J04730	10.05				
	2.2 D	114	J04730	10.05				
								

<sup>1)</sup> - Europa / - Europe / - Europa / - Europa

























								
<b>JAGUAR Type X (CF1) Saloon (01-09)</b>								
	2.5 V6 3.0 V6	144 169	J04730 J04730	06.01 06.01			G1020562	23279 18,4 /S BOS
	2.0 D 2.0 V6 2.2 D 2.2 D 2.2 D 2.5 V6 3.0 V6	96 115 107 110 114 144 169		07.03 03.02 01.07 10.05 10.05 06.01 06.01	11.09 10.05 11.09 11.09 11.09 11.09 11.07		G2124161	300 23,9 22,0 V +C
	2.0 D 2.0 V6 2.2 D 2.2 D 2.2 D 2.5 V6 3.0 V6	96 115 107 110 114 144 169	E73993 E73993 E73993 E73993 E73993 E73993 E73993	07.03 03.02 01.07 10.05 10.05 06.01 06.01			G1020563	23557 17,2 /S BOS
	2.0 D 2.0 V6 2.2 D 2.2 D 2.2 D 2.5 V6 3.0 V6	96 115 107 110 114 144 169	E73994 E73994 E73994 E73994 E73994 E73994 E73994		11.09 10.05 11.09 11.09 11.09 11.09 11.07		G1020625	24260 16,4 /Acc/S BOS
	2.0 D 2.0 V6 2.2 D 2.2 D 2.2 D 2.5 V6 3.0 V6	96 115 107 110 114 144 169		07.03 03.02 01.07 10.05 10.05 06.01 06.01	11.09 10.05 11.09 11.09 11.09 11.09 11.07		G2112154	280 12,0 10,0 +C
<b>JAGUAR Type X (CF1) Estate (03-09)</b>								
	2.0 D 2.0 V6 2.2 D 2.2 D 2.2 D 2.5 V6 3.0 V6	96 115 107 110 114 144 169	J04730 J04730 J04730 J04730 J04730 J04730 J04730	02.04 11.03 01.07 10.05 10.05 02.04 02.04			G1020562	23279 18,4 /S BOS
	2.0 D 2.0 V6 2.2 D 2.2 D 2.2 D 2.5 V6 3.0 V6	96 115 107 110 114 144 169		02.04 11.03 01.07 10.05 10.05 02.04 02.04	12.09 03.09 12.09 12.09 12.09 12.09 12.09		G2124161	300 23,9 22,0 V +C
	2.0 D 2.0 V6 2.2 D 2.2 D 2.2 D 2.5 V6 3.0 V6	96 115 107 110 114 144 169	E73993 E73993 E73993 E73993 E73993 E73993 E73993	02.04 11.03 01.07 10.05 10.05 02.04 02.04			G1020563	23557 17,2 /S BOS
	2.0 D 2.0 V6 2.2 D 2.2 D 2.2 D 2.5 V6 3.0 V6	96 115 107 110 114 144 169	E73994 E73994 E73994 E73994 E73994 E73994 E73994		12.09 03.09 12.09 12.09 12.09 12.09 12.09		G1020625	24260 16,4 /Acc/S BOS
	2.0 D 2.0 V6 2.2 D 2.2 D 2.2 D 2.5 V6 3.0 V6	96 115 107 110 114 144 169		02.04 11.03 01.07 10.05 10.05 02.04 02.04	12.09 03.09 12.09 12.09 12.09 12.09 12.09		G2112154	280 12,0 10,0 +C
<b>JEEP CHEROKEE (KJ) (01-08)</b>								
	2.4 16V 2.4 16V Laredo 2.5 CRD 2.8 CRD 2.8 CRD 3.7 4WD 3.7 V6 3.7 V6 3.7 V6 Laredo	108 108 105 110 120 157 150 155 150		09.01 10.01 09.01 11.02 11.04 10.04 08.03 09.01 10.01	01.08 09.04 01.08 01.08 01.08 10.07 01.08 01.08 09.04		G1205238	23638 18,3 +WI LUC
<b>JEEP COMPASS (MK49) (06-)</b>								
	2.0 16V 2.0 CRD 2.0 CRD 4x4 2.2 CRD 2.2 CRD 4x4	115 103 103 100 120		05.11 08.06 09.06 05.11 12.10	+ 17" wheel <sup>1)</sup> + 17" wheel <sup>1)</sup>		G1205241	23584 16,4 /WI AKE



















<sup>1)</sup> + ruota 17" / + roue 17" / + rueda 17" / + 17" Rad

							
<b>JEEP COMPASS (MK49) (06-)</b>							
	2.4 16V 2.4 16V 4x4	125 125		09.06 09.06	+ 17" wheel <sup>1)</sup> + 17" wheel <sup>1)</sup>	G1205241	23584 16,4 /WI AKE
	2.0 16V 2.2 CRD 2.2 CRD 4x4	115 100 120		05.11 05.11 12.10	+ 18" wheel <sup>2)</sup> + 18" wheel <sup>2)</sup> + 18" wheel <sup>2)</sup>	G1205230	23582 16,0 +
<b>JEEP PATRIOT (MK74) (07-)</b>							
	2.2 CRD 4x4	100		01.11		G1205241	23584 16,4 /WI AKE
	2.0 16V 2.0 CRD 2.0 CRD 4x4 2.2 CRD 4x4 2.2 CRD 4x4 2.4 16V 2.4 16V 4x4 2.4 Eco + 4x4	115 103 103 100 120 125 125 125		01.11 02.07 02.07 01.11 01.11 06.09 01.08 07.08	+ 18" wheel <sup>2)</sup> + 18" wheel <sup>2)</sup>	G1205230	+ ABS 23582 16,0 +
<b>KIA CARENS II (02-06)</b>							
	1.6 i 16V 1.8 i 16V 2.0 CRDi 2.0 CRDi 2.0 CVT	77 93 83 103 102		07.02 07.02 07.02 11.05 08.04	04.06 04.06 04.06 04.06 04.06	G1201002	23966 17,7 +/WI
<b>KIA CEE'D Saloon (06-)</b>							
	1.4 16V 1.4 16V 1.4 16V 1.6 16V 1.6 16V 1.6 16V 1.6 16V 1.6 16V 1.6 CRDi 115 1.6 CRDi 128 1.6 CRDi 90 2.0 16V 2.0 CRDi	66 77 80 85 90 92 93 85 94 66 105 103		06.10 12.06 12.06 09.07 12.06 10.10 02.08 12.06 10.10 12.06 12.06 09.07		G1201002	23966 17,7 +/WI
	1.4 16V 1.4 16V 1.4 16V 1.6 16V 1.6 16V 1.6 16V 1.6 16V 1.6 16V 1.6 CRDi 115 1.6 CRDi 128 1.6 CRDi 90 2.0 16V 2.0 CRDi	66 77 80 85 90 92 93 85 94 66 105 103		06.10 12.06 12.06 09.07 12.06 10.10 02.08 12.06 10.10 12.06 12.06 09.07		G2126150	280 26,0 24,4 V L +C
	1.4 16V 1.4 16V 1.4 16V 1.6 16V 1.6 16V 1.6 16V 1.6 16V 1.6 16V 1.6 CRDi 115 1.6 CRDi 128 1.6 CRDi 90 2.0 16V 2.0 CRDi	66 77 80 85 90 92 93 85 94 66 105 103		06.10 12.06 12.06 09.07 12.06 10.10 02.08 12.06 10.10 12.06 12.06 09.07		G1201035	24320 15,3 +/WI/ACC
<b>KIA CEE'D Estate (07-)</b>							
	1.4 16V 1.4 16V 1.4 16V 1.6 16V 1.6 16V 1.6 16V 1.6 16V 1.6 16V 1.6 CRDi 115 1.6 CRDi 128 1.6 CRDi 90 2.0 16V 2.0 CRDi	66 77 80 85 90 92 93 85 94 66 105 103		10.10 10.10 09.07 09.07 09.07 06.09 09.07 09.07 09.07 10.10 09.07 09.07 09.07		G1201002	23966 17,7 +/WI
	1.4 16V 1.4 16V 1.4 16V 1.6 16V 1.6 16V 1.6 16V 1.6 16V 1.6 CRDi 115 1.6 CRDi 128	66 77 80 85 90 92 93 85 94		10.10 10.10 09.07 09.07 09.07 06.09 09.07 09.07 10.10		G2126150	280 26,0 24,4 V L +C

<sup>1)</sup> + ruota 17" / + roue 17" / + rueda 17" / + 17" Rad



<sup>2)</sup> + ruota 18" / + roue 18" / + rueda 18" / + 18" Rad

								
<b>KIA CEE'D Estate (07-)</b>								
	1.6 CRDi 90 2.0 16V 2.0 CRDi	66 105 103		09.07 09.07 09.07			G2126150	280 26,0 24,4 V L +C
	1.4 16V 1.4 16V 1.4 16V 1.6 16V 1.6 16V 1.6 16V 1.6 16V 1.6 CRDi 115 1.6 CRDi 128 1.6 CRDi 90 2.0 16V 2.0 CRDi	66 77 80 85 90 92 93 85 94 66 105 103		10.10 10.10 09.07 09.07 09.07 06.09 09.07 09.07 10.10 09.07 09.07 09.07			G1201035	24320 15,3 +/W/IAcc
<b>KIA PICANTO (BA) (04-11)</b>								
	1.0 1.0 1.1 1.1 CRDi	45 46 48 55		09.05 04.11 11.09 04.11 04.04 04.11 11.05 04.11			G1201047	24275 16,5 +/W/IAcc
	1.0 1.0 1.1	45 46 48		09.05 04.11 11.09 04.11 04.04 04.11			G2118145	241 18,0 16,0 V +C
	1.0 1.0 1.1 1.1 CRDi	45 46 48 55		09.05 04.11 + ABS 11.09 04.11 + ABS 04.04 04.11 + ABS 11.05 04.11 + ABS			G2110324	234 10,0 8,0 +C
<b>KIA PICANTO (TA) (11-)</b>								
	1.0 12V 1.0 Bi-Fuel 1.0 Bi-Fuel 1.2 16V	51 59 60 63		05.11 05.11 05.11 09.11			G1201047	24275 16,5 +/W/IAcc
	1.0 12V 1.0 Bi-Fuel 1.0 Bi-Fuel 1.2 16V	51 59 60 63		05.11 05.11 05.11 09.11			G2118145	241 18,0 16,0 V +C
	1.0 12V 1.0 Bi-Fuel 1.0 Bi-Fuel 1.2 16V	51 59 60 63		05.11 05.11 05.11 09.11			G2110324	234 10,0 8,0 +C
<b>KIA PRIDE (05-)</b>								
	1.4 i 16V 1.5 CRDi 1.6 i 16V	71 81 82		03.05 03.05 03.05			G1201033	24317 17,6 +/W/IAcc
	1.4 i 16V 1.5 CRDi 1.6 i 16V	71 81 82		03.05 03.05 03.05	+ ABS + ABS + ABS		G1201035	24320 15,3 +/W/IAcc
	1.4 i 16V 1.5 CRDi 1.6 i 16V	71 81 82		03.05 03.05 03.05	+ ABS + ABS + ABS		G2110312	262 10,0 8,4 +C
<b>KIA PRO CEE'D (08-)</b>								
	1.4 16V 1.4 16V 1.4 16V 1.6 16V 1.6 16V 1.6 16V 1.6 16V 1.6 CRDi 115 1.6 CRDi 128 1.6 CRDi 90 2.0 16V 2.0 CRDi 140	66 77 80 85 90 92 93 85 94 66 105 103		06.10 02.08 02.08 02.08 02.08 10.10 02.08 02.08 10.10 02.08 02.08 02.08			G1201002	23966 17,7 +/W/IAcc
	1.4 16V 1.4 16V 1.4 16V 1.6 16V 1.6 16V 1.6 16V 1.6 16V 1.6 CRDi 115 1.6 CRDi 128 1.6 CRDi 90 2.0 16V 2.0 CRDi 140	66 77 80 85 90 92 93 85 94 66 105 103		06.10 02.08 02.08 02.08 02.08 10.10 02.08 02.08 10.10 02.08 02.08 02.08			G2126150	280 26,0 24,4 V L +C
	1.4 16V 1.4 16V 1.4 16V 1.6 16V 1.6 16V 1.6 16V 1.6 16V	66 77 80 85 90 92 93		06.10 02.08 02.08 02.08 02.08 10.10 02.08			G1201035	24320 15,3 +/W/IAcc

								
<b>KIA PRO CEE'D (08-)</b>								
	1.6 CRDi 115 1.6 CRDi 128 1.6 CRDi 90 2.0 16V 2.0 CRDi 140	85 94 66 105 103		02.08 10.10 02.08 02.08 02.08			G1201035	24320 15,3 +/W/ACC
<b>KIA RIO II (JB) (05-)</b>								
	1.4 i 16V 1.5 CRDi 1.6 i 16V	71 81 82		03.05 03.05 03.05			G1201033	24317 17,6 +/W/ACC
	1.4 i 16V 1.5 CRDi 1.6 i 16V	71 81 82		03.05 03.05 03.05	+ ABS + ABS + ABS		G1201035	24320 15,3 +/W/ACC
	1.4 i 16V 1.5 CRDi 1.6 i 16V	71 81 82		03.05 03.05 03.05	+ ABS + ABS + ABS		G2110312	262 10,0 8,4 +C
<b>KIA SORENTO (JC) (02-09)</b>								
	2.4 i 16V 2.5 CRDi 2.5 CRDi 2.5 CRDi 3.3 i V6 3.3 i V6 3.5 i V6	102 103 120 125 177 182 143		08.02 08.02 05.06 12.06 12.06 11.07 08.02	11.06 11.06 10.09 10.09 10.09 10.09 10.09		G1201025	24058 15,5 +/W/ACC
<b>KIA SOUL (09-)</b>								
	1.6 CRDi 115 1.6 CRDi 128 1.6 CVVT 1.6 CVVT 1.6 CVVT 1.6 Flex 1.6 GDI	85 94 77 93 95 94 103		02.09 02.09 02.09 02.09 03.12 01.11 06.11			G2126150	280 26,0 24,4 V L +C
<b>KIA SPORTAGE (04-10)</b>								
	2.0 CRDi 2.0 CRDi 2.0 CRDi 2.0 CRDi 2.0 CRDi 4WD 2.0 CRDi 4WD 2.0 CRDi 4WD 2.0 CRDi 4WD 2.0 CRDi 4WD 2.0 i 16V 2.0 i 16V 4WD	83 100 103 110 83 100 103 110 110 104 104		01.07 01.07 01.07 09.08 01.07 01.07 01.07 09.08 09.08 01.07 01.07	05.10 05.10 05.10 05.10 05.10 05.10 05.10 05.10 05.10 05.10 05.10		G1201035	24320 15,3 +/W/ACC
<b>KIA SPORTAGE (10-)</b>								
	1.6 16V 1.6 GDI 1.7 CRDi 2.0 16V 2.0 16V 2.0 16V AWD 2.0 16V AWD 2.0 CRDi 2.0 CRDi 2.0 CRDi AWD 2.0 CRDi AWD	99 99 85 110 120 110 120 100 135 100 100 135		07.10 02.11 02.11 07.10 07.10 07.10 07.10 07.10 08.10 07.10 07.10 08.10			G1201035	24320 15,3 +/W/ACC
<b>KIA VENGA (10-)</b>								
	1.4 CRDi 75 1.4 CRDi 75 1.4 CRDi 90 1.4 CVVT 1.6 CRDi 115 1.6 CRDi 128 1.6 CVVT	55 57 66 66 85 94 92		02.10 02.10 02.10 02.10 02.10 02.10 02.10			G2126150	280 26,0 24,4 V L +C
	1.4 CRDi 75 1.4 CRDi 75 1.4 CRDi 90 1.4 CVVT 1.6 CRDi 115 1.6 CRDi 128 1.6 CVVT	55 57 66 66 85 94 92		02.10 02.10 02.10 02.10 02.10 02.10 02.10			G1020610	23417 15,3 +/W/ACC/S LUC
<b>LANCIA DEDRA (94-99)</b>								
	1.6 1.8 i.e. 2.0 i.e.			11.93 11.93 11.93	08.99 08.99 08.99		G1020140	20839 17,0 /W/S LUC
	1.9 TD 1.9 TD 1.9 TD 1.6 1.8 i.e.	68 66		11.93 11.93 11.93 01.96 11.93	08.99 08.99 08.99 07.99 08.99	- catalytic converter 1) + catalytic converter 2)	G1020342 G2112127 G2122147 G2120142	21927 17,9 +/W/ ATE 258 12,0 10,2 +C 284 22,0 20,2 V +C 258 20,0 18,2 V L +C

1) - catalizzatore / - catalyseur / - catalizador / - Katalysator

2) + catalizzatore / + catalyseur / + catalizador / + Katalysator

								
<b>LANCIA DEDRA (94-99)</b>								
	2.0 i.e.			11.93	08.99		G2120142	258 20,0 18,2 V L +C
	1.8 GT 16V			03.96	08.99		G2122197	258 22,0 20,2 V +C
	2.0 i.e. 16V			11.93	08.99			
	1.8 GT 16V			03.96	08.99		G1020236	+ cast iron caliper <sup>1)</sup>
	1.8 i.e.			11.93	08.99		G1020384	+ aluminium calipers <sup>2)</sup>
	1.9 TD			11.93	08.99			21103 14,2 /S
	2.0 i.e.			11.93	08.99			23177 14,2 /S
	2.0 i.e. 16V			11.93	08.99			
<b>LANCIA DELTA (94-99)</b>								
	1.4 i.e.			11.93	08.99		G1020340	21930 17,9 +/WI
	1.6 i.e.			11.93	08.99			
	1.6 i.e.	66		11.93	08.99		G1020342	21927 17,9 +/WI
	1.8			02.96	09.99		G1020140	20839 17,0 /WI/S
	1.8 i.e.			11.93	08.99			
	2.0 TD			07.94	08.99			
	1.6 i.e.	66		11.93	08.99		G2112127	258 12,0 10,2 +C
	1.8			02.96	09.99			
	1.8 i.e.			11.93	08.99			
	2.0 TD			07.94	08.99			
	2.0 HF Turbo			11.93	08.99		G2122147	284 22,0 20,2 V +C
	1.8	66		02.96	09.99		G1020236	+ cast iron caliper <sup>1)</sup>
	1.8 i.e.			11.93	08.99		G1020384	+ aluminium calipers <sup>2)</sup>
	2.0 HF Turbo			11.93	08.99			21103 14,2 /S
	2.0 i.e. 16V			11.93	08.99			23177 14,2 /S
	2.0 TD			07.94	08.99			
	2.0 HF Integrale			11.93	08.99		G2110209	251 10,0 9,0 +C
	2.0 i.e.16V Integrale			11.93	08.99			
<b>LANCIA DELTA (08-)</b>								
	1.4 16V	88		08.08			G1020503	23708 19,0 +/WI/S
	1.4 Bifuel	88		07.11				
	1.6 D Multijet	77		04.11				
	1.6 D Multijet	88		08.08				
	1.4 16V	103		07.10			G1020504	23711 19,4 +/WI/S
	1.4 16V Turbo	110		08.08				
	1.4 16V	88		08.08			G2122147	284 22,0 20,2 V +C
	1.4 Bifuel	88		07.11				
	1.6 D Multijet	77		04.11				
	1.6 D Multijet	88		08.08				
	1.4 16V	88		08.08			G1020515	23714 16,6 /S
	1.4 16V	103		07.10			G1201128	23714 17,6 +/WI/Acc/S
	1.4 16V Turbo	110		08.08				
	1.4 Bifuel	88		07.11				
	1.6 D Multijet	77		04.11				
	1.6 D Multijet	88		08.08				
	1.8 Di 16V	147		01.09				
	1.9 D Multijet	140		08.08				
	2.0 D Multijet	121		08.08				
	1.4 16V	88		08.08			G2110190	252 10,0 9,0 +C
	1.4 16V	103		07.10				
	1.4 16V Turbo	110		08.08				
	1.4 Bifuel	88		07.11				
	1.6 D Multijet	77		04.11				
	1.6 D Multijet	88		08.08				
	1.8 Di 16V	147		01.09				
	1.9 D Multijet	140		08.08				
	2.0 D Multijet	121		08.08				
<b>LANCIA FLAVIA (12-)</b>								
	2.4 16V	125		03.12			G1205241	23584 16,4 /WI
	2.4 16V	125		03.12			G1205230	23582 16,0 +
<b>LANCIA KAPPA (95-01)</b>								
	2.0 i.e.			01.95	10.01		G1020359	21606 16,7 /S
	2.0 i.e. 16V Turbo			07.95	10.01			
	2.0 i.e. 20V Turbo			06.98	10.01			
	2.4 i.e.			01.95	10.01			
	2.4 JTD			06.98	10.01			
	2.4 TD			01.95	10.01			
	3.0 i.e. V6			01.95	10.01			
<b>LANCIA LYBRA (99-05)</b>								
	1.6 i 16V			10.99	02.00		G1020392	23140 19,4 +/WI
	1.6			10.00	10.05		G1020500	23140 19,4 +/WI
	1.6 i 16V			03.00	12.05			
	1.8 i 16V			10.99	03.00		G1020360	21636 19,3 +/WI
	1.9 JTD			10.99	03.00			
	2.0 i 20V			10.99	03.00			
	2.4 JTD			10.99	03.00			

<sup>1)</sup> + pinza in ghisa / + étriers en fonte grise / + fundición gris-pinza / + GG-Sättel  
<sup>2)</sup> + pinze in alluminio / + étriers en aluminium / + pinzas de aluminio / + ALU-Sättel



LANCIA LYBRA (99-05)											
	1.8 i 16V 1.9 JTD 2.0 i 20V 2.4 JTD			04.00 04.00 04.00 04.00	12.05 12.05 12.05 12.05			G1020473		23289 19,3 +/Wl	ATE
	1.6 1.8 i 16V 1.9 JTD 2.0 i 20V 2.4 JTD			10.00 10.99 10.99 10.99 10.99	10.05 12.05 12.05 12.05 12.05			G2122147		284 22,0 20,2 V +C	
	1.6 1.6 i 16V 1.8 i 16V 1.9 JTD 2.0 i 20V 2.4 JTD			10.00 10.99 10.99 10.99 10.99 10.99	10.05 12.05 12.05 12.05 12.05 12.05			G1020568		23517 16,6 /S	LUC
	1.6 1.6 i 16V 1.8 i 16V 1.9 JTD 2.0 i 20V 2.4 JTD			10.00 10.99 10.99 10.99 10.99 10.99	10.05 12.05 12.05 12.05 12.05 12.05			G2110190		252 10,0 9,0 +C	

LANCIA MUSA (04-12)											
	1.4 1.4 1.4 1.4 LPG	57 66 70 57		07.05 10.07 10.04 11.10	07.12 07.12 07.12 07.12			G1020740		23706 18,0 +/Wl/S	BOS
	1.3 D Multijet 1.3 D Multijet 1.3 D Multijet 1.6 D Multijet 1.6 D Multijet 1.9 D Multijet	51 66 70 85 88 74		10.04 09.06 08.09 07.08 06.08 10.04	07.12 07.12 07.12 07.12 07.12 07.12			G1020614 G1020738		23708 19,0 /S 23709 19,0 +/Wl/Acc/S	BOS BOS
	1.4 1.4 1.4 1.4 LPG	57 66 70 57		07.05 10.07 10.04 11.10	07.12 07.12 07.12 07.12			G2122197		258 22,0 20,2 V +C	
	1.3 D Multijet 1.3 D Multijet 1.3 D Multijet 1.6 D Multijet 1.6 D Multijet 1.9 D Multijet	51 66 70 85 88 74		10.04 09.06 08.09 07.08 06.08 10.04	07.12 07.12 07.12 07.12 07.12 07.12			G2122147		284 22,0 20,2 V +C	
	1.6 D Multijet 1.6 D Multijet	85 88		07.08 06.08	07.12 07.12			G1020567		23601 13,7 /S	LUC





















LANCIA PHEDRA (02-10)											
	2.0 D Multijet 2.0 i 16V 2.0 JTD 2.2 JTD	100 100 80 94		07.06 08.02 08.02 08.02	09.10 09.10 09.10 09.10			G1020514		20261 19,0 +/Wl/S	LUC
	2.0 D Multijet 2.0 i 16V 2.0 JTD 2.2 D Multijet 2.2 JTD 2.2 JTD 3.0 i V6	100 100 80 125 94 120 150		07.06 08.02 08.02 03.08 08.02 04.06 08.02	09.10 09.10 09.10 09.10 09.10 09.10 09.10			G1020549		20961 17,1 /WD/S	LUC

LANCIA THEMA (92-94)											
	2.0 i.e. 16V Turbo 3.0 i.e. V6			10.92 10.92	12.94 12.94	- armoured vehicles <sup>1)</sup> - armoured vehicles <sup>1)</sup>		G2122147		284 22,0 20,2 V +C	
	2.0 i.e. 16V 2.0 i.e. 16V Turbo 3.0 i.e. V6			10.92 10.92 10.92	12.94 12.94 12.94	+ armoured vehicles <sup>2)</sup> + armoured vehicles <sup>2)</sup> + armoured vehicles <sup>2)</sup>		G2122145		284 22,0 20,2 V +C	
	2.0 i.e. 2.0 i.e. 16V 2.0 i.e. 16V Turbo 2.5 TD 3.0 i.e. V6			10.92 10.92 10.92 10.92 10.92	12.94 12.94 12.94 12.94 12.94	- armoured vehicles <sup>1)</sup> - armoured vehicles <sup>1)</sup> - armoured vehicles <sup>1)</sup> - armoured vehicles <sup>1)</sup> - armoured vehicles <sup>1)</sup>		G2110190		252 10,0 9,0 +C	
	2.0 i.e. 16V 2.0 i.e. 16V Turbo 3.0 i.e. V6			10.92 10.92 10.92	12.94 12.94 12.94	+ armoured vehicles <sup>2)</sup> + armoured vehicles <sup>2)</sup> + armoured vehicles <sup>2)</sup>		G2110209		251 10,0 9,0 +C	

LANCIA THESIS (02-07)											
	2.0 i 20V Turbo 2.4 i 20V 2.4 JTD 3.0 i V6 3.2 i V6			07.02 07.02 07.02 07.02 05.03	12.07 12.07 12.07 12.07 12.07			G1020572	electric parking brake <sup>3)</sup>	23760 17,7 /S	LUC

<sup>1)</sup> - veicoli blindati / - véhicules blindés / - vehiculo blindado / - gepanzerte Fahrzeuge  
<sup>2)</sup> + veicoli blindati / + véhicules blindés / + vehiculo blindado / + gepanzerte Fahrzeuge  
<sup>3)</sup> fr. di stazionamento elettrico / frein à main électrique / freno de mano eléctrico / elektrische Feststellbremse



								
<b>LANCIA Y 10 (85-95)</b>								
	1.0 Fire		06.85	12.95		G1020141	20775 18,0 /W/	BDX
	1.0 Fire 4WD		12.86	12.95				
	1.1 4WD		01.90	12.95				
	1.1 Fire		01.90	12.95				
	1.0 Turbo		06.85	12.95		G1020140	20839 17,0 /W/S	LUC
	1.3 Fire		02.89	12.95				
<b>LANCIA Y (96-03)</b>								
	1.1 i		05.97	12.98		G1020305	21436 16,2	BDX
	1.2 i	44	10.00	07.03	- ABS	G1020298	21436 16,2 /W/	BDX
	1.2 i	44	01.96	09.00				
	1.2 i	44	10.00	07.03	+ ABS	G1020351	23181 17,9 +	ATE
	1.2 i 16V	59	10.00	07.03				
	1.2 i 16V	63	05.97	09.00				
	1.4 i		01.99	07.03				
	1.4 i		01.96	12.98		G1020140	20839 17,0 /W/S	LUC
	1.2 i	44	10.00	07.03	+ ABS	G2112127	258 12,0 10,2 +C	
	1.2 i 16V	59	10.00	07.03				
	1.2 i 16V	63	05.97	09.00				
	1.4 i		01.96	12.98				
<b>LANCIA YPSILON (03-11)</b>								
	1.2 i	44	06.03	07.06		G1020573	24073 16,7 /S	LUC
	1.2 i 16V	59	06.03	07.06				
	1.3 JTD	51	06.03	07.06				
	1.4 i	57	02.06	07.06				
	1.4 i 16V	70	06.03	07.06				
	1.2 i	44	08.06	06.11		G1020896	24073 16,7 +/W/S	LUC
	1.2 i 16V	59	08.06	06.11				
	1.3 JTD	51	08.06	06.11				
	1.3 JTD	55	10.06	06.11				
	1.3 JTD	66	10.06	06.11				
	1.3 JTD	77	07.07	06.11				
	1.4 i	57	08.06	06.11				
	1.4 i 16V	70	08.06	06.11				
	1.2 i	44	06.03	06.11		G2112127	258 12,0 10,2 +C	
	1.4 i	57	02.06	06.11				
	1.2 i 16V	59	06.03	06.11		G2122197	258 22,0 20,2 V +C	
	1.3 JTD	51	06.03	06.11				
	1.3 JTD	55	10.06	06.11				
	1.3 JTD	66	10.06	06.11				
	1.3 JTD	77	07.07	06.11				
	1.4 i 16V	70	06.03	06.11				
<b>LANCIA YPSILON (11-)</b>								
	0.9	63	07.11			G2122197	258 22,0 20,2 V +C	
	1.3 D Multijet	70	07.11					
	1.2	51	07.11			G2112127	258 12,0 10,2 +C	
	1.2 Bifuel	49	07.11					
<b>LANCIA ZETA (94-02)</b>								
	2.0 i.e. 16V		05.98	09.02		G1020310	21801 19,0 +/W/S	LUC
	2.0 i.e. Turbo		06.94	09.02				
	2.0 JTD		09.99	09.02				
	2.1 TD		06.96	09.99				
	2.0 i.e. 16V		05.98	09.02	+ ABS	G1020291	21275 17,0 +/W/	ATE
	2.0 i.e. Turbo		06.94	09.02				
	2.0 JTD		09.99	09.02	+ ABS			
	2.1 TD		06.96	09.99				
<b>LAND ROVER FREELANDER (LN) (98-06)</b>								
	1.8 i 16V	86 1A000001	10.06			G1020901	23615 18,3 /S	LUC
	2.0 TD4	80 1A000001	10.06					
	2.0 TD4	82 1A000001	10.06					
	2.5 V6	130 1A000001	10.06					
<b>LAND ROVER FREELANDER 2 (FA) (07-)</b>								
	2.2 SD4	140	08.10			G1020889	24123 20,3 +	ATE
	2.2 TD4	110	08.10					
	2.2 TD4	112	01.07					
	2.2 TD4	118	10.06					
	2.2 TD4 4x4	110	10.06					
	2.2 TD4 4x4	115	10.06					
	3.2	171	01.07					
	2.2 SD4	140	08.10			G2128154	300 28,0 26,0 V L +S +C	
	2.2 TD4	110	08.10					
	2.2 TD4	112	01.07					
	2.2 TD4	118	10.06					
	2.2 TD4 4x4	110	10.06					
	2.2 TD4 4x4	115	10.06					
	2.2 SD4	140	08.10			G1201135	24537 15,8 /Acc/S	LUC
	2.2 TD4	110	08.10					
	2.2 TD4	112	01.07					
	2.2 TD4	118	10.06					
	2.2 TD4 4x4	110	10.06					
	2.2 TD4 4x4	115	10.06					













































LAND ROVER RANGE ROVER III (LM) (02-12)														
	3.0 TD 6	130	5A999999	03.02						- armoured vehicles <sup>1)</sup> - armoured vehicles <sup>1)</sup> - armoured vehicles <sup>1)</sup> - armoured vehicles <sup>1)</sup> - armoured vehicles <sup>1)</sup>	G1020367	21487 17,3 +WD	ATE	
	3.6 TD 8	200	5A999999	04.06										
	4.2	291	5A999999	05.05										
	4.4	210	5A999999	03.02										
	4.4	225	5A999999	05.05										
LAND ROVER RANGE ROVER EVOQUE (SAL) (11-)														
	2.0 16V	177		06.11							G2128154	300 28,0 26,0 V L +S +C		
	2.2 eD4	110		06.11										
	2.2 SD4	140		06.11										
	2.2 TD4	110		06.11										
	2.0 16V	177		06.11							G1020787	24496 17,3 /Acc/S	LUC	
	2.2 eD4	110		06.11										
	2.2 SD4	140		06.11										
	2.2 TD4	110		06.11										
	2.0 16V	177		06.11							G2111145	302 10,9 9,0 +C		
	2.2 eD4	110		06.11										
	2.2 SD4	140		06.11										
	2.2 TD4	110		06.11										
LEXUS CT 200 (11-)														
	200h (ZWA10)	73		03.11							G1020975	24610 15,0 +/WI		
LEXUS ES 350 (06-12)														
	3.5 V6	204		03.06	06.12						G1201022	24338 15,5	AKE	
LEXUS GX 470 (J12) (01-09)														
	4.7 V8	175		11.01	11.09						G1205333	24024 17,0 +/WI		
	4.7 V8	199		11.01	11.09									
	4.7 V8	175		11.01	11.09						G1205404	21947 15,4		
	4.7 V8	199		11.01	11.09									
LEXUS GX 470 (URJ15) (09-)														
	4.7 V8	218		11.09							G1205333	24024 17,0 +/WI		
	4.7 V8	225		01.10										
	4.7 V8	218		11.09							G1205404	21947 15,4		
	4.7 V8	225		01.10										
LEXUS HS 250 (ANF) (09-)														
	250h Hybrid	110		09.09							G1201065	24336 17,5	AKE	
	250h Hybrid	110		09.09							G1201022	24338 15,5	AKE	
MAZDA 121 (96-03)														
	1.25 i 16V	55		03.96	01.00	+ manual transmission <sup>2)</sup>					G1020333	21202 16,9 +	ATE	
	1.3 i	37		03.96	01.00									
	1.3 i	44		03.96	01.00									
	1.8 D	44		03.96	01.00									
	1.25 i 16V	55		03.96	01.00	+ autom.transmission <sup>3)</sup>					G1020334	20640 17,5 +	ATE	
	1.25 i 16V	55		02.00	03.03									
	1.3 i	37		02.00	03.03									
	1.3 i	44		02.00	03.03									
	1.8 D	44		02.00	03.03						G1020467 G1020519	- ABS + ABS	23200 18,0 + 23604 17,8 +	ATE ATE
	1.25 i 16V	55		03.96	01.00	+ manual transmission <sup>2)</sup>								
	1.3 i	37		03.96	01.00									
	1.3 i	44		03.96	01.00									
	1.8 D	44		03.96	01.00						G2112141	239 12,0 10,0 +C		
	1.25 i 16V	55		03.96	01.00	+ autom.transmission <sup>3)</sup>								
	1.25 i 16V	55		02.00	03.03									
	1.3 i	37		02.00	03.03									
	1.3 i	44		02.00	03.03						G2120147 G2122172	- ABS + ABS	240 20,0 18,0 V +C 258 22,0 20,0 V +C	
	1.3 i	44		02.00	03.03									
	1.3 i	44		02.00	03.03									
	1.8 D	44		02.00	03.03									
MAZDA 2 (DY) (03-07)														
	1.2 16V	55		04.03	09.07						G1020519	23604 17,8 +	ATE	
	1.25 16V	55		04.03	09.07									
	1.3 16V	67		04.03	09.07									
	1.4 16V	59		02.03	09.07									
	1.4 CD	50		04.03	09.07									
	1.6 16V	74		02.03	09.07									

<sup>1)</sup> - veicoli blindati / - véhicules blindés / - vehículo blindado / - gepanzerte Fahrzeuge  
<sup>2)</sup> + scatola cambio velocità / + transmission mécanique / + cambio de velocidad / + Schaltgetriebe  
<sup>3)</sup> + scatola cambio automatico / + transmission automatique / + cambio automático / + Automatikgetriebe



























								
<b>MAZDA 2 (DY) (03-07)</b>								
	1.2 16V 1.25 16V 1.3 16V 1.4 16V 1.4 CD 1.6 16V	55 55 67 59 50 74		04.03 04.03 04.03 02.03 04.03 02.03	09.07 09.07 09.07 09.07 09.07 09.07	G2122172		258 22,0 20,0 V +C
<b>MAZDA 2 (DE) (07-)</b>								
	1.3 16V 1.3 16V 1.3 MZR 1.4 MZR-CD 1.5 16V 1.5 MZR 1.6 MZ-CD 1.6 MZ-CD	55 63 62 50 76 75 66 70		10.07 10.07 01.10 01.08 10.07 06.11 10.08 06.11		G1201053		24283 15,5 +/M/Acc/S
<b>MAZDA 3 (BK) (03-09)</b>								
	1.4 i 16V 1.4 i 16V 1.6 CiTD 1.6 i 16V 2.0 i 16V 2.0 MZR-CD 2.3 i 16V 2.3 i 16V Sport 2.3 MPS	59 62 80 77 110 105 118 126 191		10.03 10.03 06.04 10.03 10.03 12.06 10.03 10.03 12.06	05.09 03.06 05.09 05.09 05.09 05.09 09.04 05.09 05.09	G1020622		23723 18,1 + ATE
	1.4 i 16V 1.4 i 16V 1.6 CiTD 1.6 i 16V 2.0 i 16V 2.0 MZR-CD 2.3 i 16V 2.3 i 16V Sport	59 62 80 77 110 105 118 126		10.03 10.03 06.04 10.03 10.03 12.06 10.03 10.03	05.09 03.06 05.09 05.09 05.09 05.09 09.04 05.09	G2125165		278 25,0 23,0 V L +C
	2.0 i 16V 2.0 MZR-CD 2.3 i 16V 2.3 i 16V Sport	110 105 118 126		10.03 12.06 10.03 10.03	05.09 05.09 09.04 05.09	G2125170		300 25,0 23,0 V L +C
	1.4 i 16V 1.4 i 16V 1.6 CiTD 1.6 i 16V 2.0 i 16V 2.0 MZR-CD 2.3 i 16V 2.3 i 16V Sport 2.3 MPS	59 62 80 77 110 105 118 126 191		10.03 10.03 06.04 10.03 10.03 12.06 10.03 10.03 12.06	05.09 03.06 05.09 05.09 05.09 05.09 09.04 05.09 05.09	G1020727		23482 16,6 + ATE
	1.4 i 16V 1.4 i 16V 1.6 CiTD 1.6 i 16V	59 62 80 77		10.03 10.03 06.04 10.03	05.09 03.06 05.09 05.09	G2111164		265 11,0 9,0 +C
<b>MAZDA 3 (BL) (09-)</b>								
	1.6 MZR 1.6 MZR-CD 1.6 MZR-CD 2.0 MZR 2.0 MZR DISI 2.2 MZR-CD 2.2 MZR-CD 2.3 MPS Turbo	77 80 85 110 111 110 136 191		06.09 06.09 11.10 06.09 06.09 06.09 06.09 06.09		G1020622		23723 18,1 + ATE
	1.6 MZR 1.6 MZR-CD 1.6 MZR-CD 2.0 MZR 2.0 MZR DISI 2.2 MZR-CD 2.2 MZR-CD	77 80 85 110 111 110 136		06.09 06.09 11.10 06.09 06.09 06.09 06.09		G1020772		23912 18,6 + ATE
	1.6 MZR 1.6 MZR-CD 1.6 MZR-CD 2.0 MZR 2.0 MZR DISI 2.2 MZR-CD 2.2 MZR-CD	77 80 85 110 111 110 136		06.09 06.09 11.10 06.09 06.09 06.09 06.09		G2125165		278 25,0 23,0 V L +C
	2.0 MZR 2.0 MZR DISI 2.2 MZR-CD 2.2 MZR-CD	110 111 110 136		06.09 06.09 06.09 06.09		G2125170		300 25,0 23,0 V L +C
	1.6 MZR 1.6 MZR-CD 1.6 MZR-CD 2.0 MZR 2.0 MZR DISI 2.2 MZR-CD 2.2 MZR-CD 2.3 MPS Turbo	77 80 85 110 111 110 136 191		06.09 06.09 11.10 06.09 06.09 06.09 06.09 06.09		G1020727		23482 16,6 + ATE
	1.6 MZR 1.6 MZR-CD 1.6 MZR-CD 2.0 MZR 2.0 MZR DISI	77 80 85 110 111		06.09 06.09 11.10 06.09 06.09		G2111164		265 11,0 9,0 +C
<b>MAZDA 323 Saloon/323 F/323 P/323 S (98-03)</b>								
	1.6 i 16V (B.J) 1.6 i 16V (B.J) 1.8 i 16V (B.J) 2.0 D (B.J) 2.0 DiTD (B.J) 2.0 i 16V (B.J)	70 72 84 52 74 96		01.01 01.01 08.98 08.98 01.01 01.01	10.03 10.03 12.00 12.00 10.03 10.03	G1020721		24045 13,7 AKE

								
<b>MAZDA 323 Saloon/323 F/323 P/323 S (98-03)</b>								
	2.0 TD (BJ)	66	08.98	12.00		G1020721		24045 13,7 AKE
	2.0 i 16V (BJ)	96	01.01	10.03	+ sports suspension <sup>1)</sup>	G2110302		280 10,0 8,0 +C
<b>MAZDA 5 (CR) (05-10)</b>								
	1.8 16V 2.0 16V 2.0 CiTD 2.0 CiTD	85 107 81 105	03.05 03.05 03.05 06.05	05.10 05.10 05.10 05.10		G1020622		23723 18,1 + ATE
	1.8 16V 2.0 16V 2.0 CiTD 2.0 CiTD	85 107 81 105	03.05 03.05 03.05 06.05	05.10 05.10 05.10 05.10		G2125165 G2125170	+ 15" wheel <sup>2)</sup> + 16" wheel <sup>3)</sup>	278 25,0 23,0 V L +C 300 25,0 23,0 V L +C
	1.8 16V 2.0 16V 2.0 CiTD 2.0 CiTD	85 107 81 105	03.05 03.05 03.05 06.05	05.10 05.10 05.10 05.10		G1020727		23482 16,6 + ATE
<b>MAZDA 5 (CW) (10-)</b>								
	1.6 CD 1.8 16V 2.0 16V 2.0 16V	85 85 106 110	09.10 09.10 01.11 09.10			G1020622		23723 18,1 + ATE
	1.6 CD 1.8 16V 2.0 16V 2.0 16V	85 85 106 110	09.10 09.10 01.11 09.10			G2125165 G2125170	+ 15" wheel <sup>2)</sup> + 16" wheel <sup>3)</sup>	278 25,0 23,0 V L +C 300 25,0 23,0 V L +C
	1.6 CD 1.8 16V 2.0 16V 2.0 16V	85 85 106 110	09.10 09.10 01.11 09.10			G1020727		23482 16,6 + ATE
<b>MAZDA 6 Saloon (GG) (02-07)</b>								
	2.0 16V 2.0 16V 2.0 DI 2.0 DI 2.0 DI 2.3 16V 2.3 16V 2.3 16V	104 108 89 100 105 118 120 122	06.02 03.05 08.02 06.02 06.05 07.03 03.05 06.02	07.07 07.07 07.07 07.07 07.07 02.05 07.07 07.07		G1020719		24046 18,6 +/Wl AKE
	1.8 16V 2.0 16V 2.0 16V 2.0 DI 2.0 DI 2.0 DI 2.3 16V 2.3 16V 2.3 16V	88 104 108 89 100 105 118 120 122	08.02 06.02 03.05 08.02 06.02 06.05 07.03 03.05 06.02	07.07 07.07 07.07 07.07 07.07 07.07 02.05 07.07 07.07		G1020721		24045 13,7 AKE
	1.8 16V 2.0 16V 2.0 16V 2.0 DI 2.0 DI 2.0 DI 2.3 16V 2.3 16V 2.3 16V	88 104 108 89 100 105 118 120 122	08.02 06.02 03.05 08.02 06.02 06.05 07.03 03.05 06.02	07.07 07.07 07.07 07.07 07.07 07.07 02.05 07.07 07.07		G2110302		280 10,0 8,0 +C
<b>MAZDA 6 Estate (GY) (02-07)</b>								
	1.8 16V 2.0 16V 2.0 16V 2.0 CiTD 4x4 2.0 CiTD 4x4 2.0 DI 2.0 DI 2.0 DI 2.3 16V 2.3 16V AWD	88 104 108 89 100 89 100 105 122 119	08.02 08.02 03.05 10.02 10.02 08.02 08.02 06.05 08.02 11.02	07.07 07.07 07.07 02.05 02.05 07.07 07.07 07.07 07.07 07.07		G1020719		24046 18,6 +/Wl AKE
	1.8 16V 2.0 16V 2.0 16V 2.0 CiTD 4x4 2.0 CiTD 4x4 2.0 DI 2.0 DI 2.0 DI 2.3 16V 2.3 16V AWD	88 104 108 89 100 89 100 105 122 119	08.02 08.02 03.05 10.02 10.02 08.02 08.02 06.05 08.02 11.02	07.07 07.07 07.07 02.05 02.05 07.07 07.07 07.07 07.07 07.07		G1020721		24045 13,7 AKE

<sup>1)</sup> + sospensione sportiva / + châssis de sport / + suspensión deportiva / + Sportfahrwerk

























<sup>2)</sup> + ruota 15" / + roue 15" / + rueda 15" / + 15" Rad

<sup>3)</sup> + ruota 16" / + roue 16" / + rueda 16" / + 16" Rad























								
<b>MAZDA 6 Estate (GY) (02-07)</b>								
	1.8 16V	88		08.02	07.07		G2110302	280 10,0 8,0 +C
	2.0 16V	104		08.02	07.07			
	2.0 16V	108		03.05	07.07			
	2.0 CiTD 4x4	89		10.02	02.05			
	2.0 CiTD 4x4	100		10.02	02.05			
	2.0 DI	89		08.02	07.07			
	2.0 DI	100		08.02	07.07			
	2.0 DI	105		06.05	07.07			
	2.3 16V	122		08.02	07.07			
	2.3 16V AWD	119		11.02	07.07			
<b>MAZDA 6 (GH) (07-)</b>								
	1.8 MZR	88		08.07			G1020721	24045 13,7 AKE
	2.0 MZR	108		08.07				
	2.0 MZR	114		01.10				
	2.0 MZR-CD	103		08.07				
	2.2 MZR-CD	92		01.09				
	2.2 MZR-CD	95		01.10				
	2.2 MZR-CD	120		01.09				
	2.2 MZR-CD	132		01.10				
	2.2 MZR-CD	136		01.09				
	2.5 MZR	125		08.07				
	1.8 MZR	88		08.07			G2110302	280 10,0 8,0 +C
	2.0 MZR	108		08.07				
	2.0 MZR	114		01.10				
	2.0 MZR-CD	103		08.07				
	2.2 MZR-CD	92		01.09				
	2.2 MZR-CD	95		01.10				
	2.2 MZR-CD	120		01.09				
	2.2 MZR-CD	132		01.10				
	2.2 MZR-CD	136		01.09				
	2.5 MZR	125		08.07				
<b>MAZDA 626 (97-02)</b>								
	2.0 DiTD (GF)			04.98	04.02		G1020721	24045 13,7 AKE
	2.0 i 16V (GF)	85		05.97	04.02			
	2.0 i 16V (GF)	100		02.98	04.02			
<b>MAZDA 626 Estate (98-02)</b>								
	1.8 i 16V (GW)	66		02.98	12.99		G1020721	24045 13,7 AKE
	1.8 i 16V (GW)	74		01.00	06.02			
	2.0 DiTD (GW)	74		04.98	06.02			
	2.0 DiTD (GW)	81		10.00	06.02			
	2.0 i 16V (GW)	85		02.98	06.02			
	2.0 i 16V (GW)	100		02.98	06.02			
	2.0 DiTD (GW)	74		04.98	06.02		G2110302	280 10,0 8,0 +C
	2.0 DiTD (GW)	81		10.00	06.02			
<b>MAZDA DEMIO (03-)</b>								
	1.2 i 16V	55		04.03			G1020519	23604 17,8 + ATE
	1.4 CD	50		04.03				
	1.4 i 16V	58		02.03				
	1.6 i 16V	74		02.03				
	1.2 i 16V	55		04.03			G2122172	258 22,0 20,0 V +C
	1.4 CD	50		04.03				
	1.4 i 16V	58		02.03				
	1.6 i 16V	74		02.03				
<b>MAZDA MX-5 (05-)</b>								
	1.8 i 16V (NC18)	93		03.05			G2110302	280 10,0 8,0 +C
	2.0 i 16V (NC18)	118		03.05				
<b>MAZDA PREMACY (CP) (99-05)</b>								
	1.8 i 16V	74		07.99	03.05 + ABS		G1020721	24045 13,7 AKE
	2.0 DiTD	74		07.00	03.05 + ABS			
	2.0 i 16V	96		11.01	03.05			
	1.8 i 16V	74		08.01	03.05 + ABS		G2110302	280 10,0 8,0 +C
	2.0 DiTD	74		08.01	03.05 + ABS			
<b>MAZDA PREMACY (CR) (05-10)</b>								
	1.8 i 16V	85		03.05	05.10 + ⊕		G1020622	23723 18,1 + ATE
	2.0 CiTD	81		03.05	05.10 + ⊕			
	2.0 CiTD	105		06.05	05.10 + ⊕			
	2.0 CiTD	107		03.05	05.10 + ⊕			
	2.0 i 16V	107		03.05	05.10 + ⊕			
	1.8 i 16V	85		03.05	05.10 + ⊕		G2125165 G2125170	278 25,0 23,0 V L +C 300 25,0 23,0 V L +C
	2.0 CiTD	81		03.05	05.10 + ⊕			
	2.0 CiTD	105		06.05	05.10 + ⊕			
	2.0 CiTD	107		03.05	05.10 + ⊕			
	2.0 i 16V	107		03.05	05.10 + ⊕			

1) + ruota 15" / + roue 15" / + rueda 15" / + 15" Rad

2) + ruota 16" / + roue 16" / + rueda 16" / + 16" Rad

										
<b>MAZDA PREMACY (CR) (05-10)</b>										
	1.8 i 16V 2.0 CiTD 2.0 CiTD 2.0 CiTD 2.0 i 16V	85 81 105 107 107		03.05 03.05 06.05 03.05 03.05	05.10 05.10 05.10 05.10 05.10	+ + + + +		G1020727	23482 16,6 +	ATE
<b>MAZDA TRIBUTE (04-08)</b>										
	2.3 i 16V AWD 3.0 i V6 AWD	110 149		04.04 04.04	05.08 05.08	+ RA disc brake <sup>1)</sup> + RA disc brake <sup>1)</sup>		G1205352	24438 16,1 +	ATE
<b>MERCEDES BENZ A-Class (W168) (97-04)</b>										
	A 140 A 160 CDI A 160 CDI	60 44 55		09.97 08.98 02.01	08.04 01.01 08.04	+ short wheel base <sup>2)</sup>		G1020440	23070 16,9 /WD/Acc/S	LUC
	A 140 A 160 A 170 CDI A 170 CDI A 190	60 75 66 70 92		09.97 09.97 03.98 02.01 05.99	08.04 08.04 01.01 08.04 08.04	- short wheel base <sup>3)</sup> - (BR)		G1201272	23070 16,9 /WD/Acc/S	LUC
	A 140 A 160 CDI A 160 CDI	60 44 55		09.97 08.98 02.01	08.04 01.01 08.04	+ short wheel base <sup>2)</sup>		G2112144	260 12,0 10,0 L +S +C	
	A 160 A 170 CDI A 190 A 210 Evolution	75 70 92 103		09.97 02.01 05.99 03.02	08.04 08.04 08.04 08.04	+ long wheel base <sup>4)</sup> + long wheel base <sup>4)</sup> - (BR)		G1020544	23138 14,6 /S	LUC
<b>MERCEDES BENZ A-Class (W169) (04-11)</b>										
	A 150 / A 160 A 160 CDI	70 60	J 215300	08.04 08.04	10.11	- increased payload <sup>5)</sup>		G1020661	24077 19,1 /WD/Acc/S	LUC
	A 160 CDI A 160 CDI A 170 A 180 A 180 CDI A 200	60 60 85 85 80 100	J 215301	08.04 10.11 08.04 04.09 08.04 08.04	10.11 10.11 10.11 10.11 10.11 10.11	+ increased payload <sup>6)</sup> + increased payload <sup>6)</sup> - increased payload <sup>5)</sup>		G1020855	24077 19,1 /WD/Acc/S	LUC
	A 200 CDI A 200 Turbo E-Cell	142 50		08.04 03.05 12.10	10.11 10.11 10.11			G1020829	23881 20,0 /WD/Acc/S	LUC
	A 150 / A 160 A 160 CDI	70 60		08.04 08.04	10.11 10.11			G2122232	276 22,0 19,4 V L +S +C	
	A 170 A 180 A 180 CDI A 200	85 85 80 100		08.04 04.09 08.04 08.04	10.11 10.11 10.11 10.11			G2122232	276 22,0 19,4 V L +S +C	
	E-Cell A 150 / A 160 A 160 CDI A 170 A 180 A 180 CDI A 200 A 200 CDI A 200 Turbo	50 70 60 85 85 80 100 100 142		12.10 08.04 08.04 08.04 04.09 08.04 08.04 08.04 03.05	10.11 10.11 10.11 10.11 10.11 10.11 10.11 10.11 10.11			G1020544 G1020852	23138 14,6 /S 23138 14,6 /Acc/S	LUC
	A 150 / A 160 A 160 CDI A 170 A 180 A 180 CDI A 200 A 200 CDI A 200 Turbo E-Cell	70 60 85 85 80 100 100 142 50		08.04 08.04 08.04 04.09 08.04 08.04 08.04 03.05 12.10	10.11 10.11 10.11 10.11 10.11 10.11 10.11 10.11 10.11			G2108113	258 8,0 7,0 +S +C	
<b>MERCEDES BENZ B-Class (W245) (05-11)</b>										
	B 150 / B 160 B 160 BlueEfficiency B 170 / B 180 B 180 BlueEfficiency	70 85		03.05 04.09 03.05 04.09	04.11 04.11 04.11 04.11			G1020855	24077 19,1 /WD/Acc/S	LUC
	B 170 NGT B 180 CDI B 180 NGT B 200 B 200 CDI B 200 Turbo	85 80 85 100 103 142		04.08 03.05 04.09 03.05 03.05 03.05	04.09 04.11 04.11 04.11 04.11 04.11			G1020829	23881 20,0 /WD/Acc/S	LUC
	B 150 / B 160 B 160 BlueEfficiency B 170 / B 180 B 180 BlueEfficiency	70 85		03.05 04.09 03.05 04.09	04.11 04.11 04.11 04.11			G2122232	276 22,0 19,4 V L +S +C	
	B 150 / B 160 B 160 BlueEfficiency B 170 / B 180 B 170 NGT B 180 BlueEfficiency	70 85 85		03.05 04.09 03.05 04.08 04.09	04.11 04.11 04.11 04.09 04.11			G1020852	23138 14,6 /Acc/S	LUC

<sup>1)</sup> + P disco freno / + frein à disque essieu AR / + ET-disco de freno / + HA-Scheibenbremse  
<sup>2)</sup> + passo lungo / + empattement court / + distancia corta entre ejes / + kurzer Radstand  
<sup>3)</sup> - passo corto / - empattement court / - distancia corta entre ejes / - kurzer Radstand  
<sup>4)</sup> + passo lungo / + empattement long / + distancia larga entre ejes / + langer Radstand  
<sup>5)</sup> - carico utile maggiorato / - charge utile augmentée / - incremento de carga / - erhöhte Zuladung  
<sup>6)</sup> + carico utile maggiorato / + charge utile augmentée / + incremento de carga / + erhöhte Zuladung

										
<b>MERCEDES BENZ B-Class (W245) (05-11)</b>										
	B 180 CDI B 180 NGT B 200 B 200 CDI B 200 Turbo	80 85 100 103 142		03.05 04.09 03.05 03.05 03.05	04.11 04.11 04.11 04.11 04.11	G1020852		23138 14,6 /Acc/S	LUC	
	B 150 / B 160 B 160 BlueEfficiency B 170 / B 180 B 170 NGT B 180 BlueEfficiency B 180 CDI B 180 NGT B 200 B 200 CDI B 200 Turbo	70 85 85 85 80 85 100 103 142		03.05 04.09 03.05 04.08 04.09 03.05 04.09 03.05 03.05 03.05	04.11 04.11 04.11 04.09 04.11 04.11 04.11 04.11 04.11 04.11	G2108113		258 8,0 7,0 +S +C		
<b>MERCEDES BENZ CITAN (W415) (12-)</b>										
	108 CDI 108 CDI BE 109 CDI 109 CDI BE	55 55 66 66		09.12 09.12 09.12 09.12	+ steel rims <sup>1)</sup> + steel rims <sup>1)</sup> + steel rims <sup>1)</sup> + steel rims <sup>1)</sup>	G1020741 G1020876	+ 14" wheel <sup>2)</sup> + 15" wheel <sup>3)</sup>	23973 17,1 /Acc/S 24693 17,5 /Acc/S	LUC LUC	
	108 CDI 108 CDI BE 109 CDI 109 CDI BE	55 55 66 66		09.12 09.12 09.12 09.12	+ light alloy rims <sup>4)</sup> + light alloy rims <sup>4)</sup> + light alloy rims <sup>4)</sup> + light alloy rims <sup>4)</sup>	G1020876	+ 15"/16" wheel <sup>5)</sup>	24693 17,5 /Acc/S	LUC	
	108 CDI 108 CDI BE 109 CDI 109 CDI BE	55 55 66 66		09.12 09.12 09.12 09.12	+ steel rims <sup>1)</sup> + steel rims <sup>1)</sup> + steel rims <sup>1)</sup> + steel rims <sup>1)</sup>	G2122270 G2124222	+ 14" wheel <sup>2)</sup> + 15" wheel <sup>3)</sup>	258 22,0 19,8 V L +S +C 280 24,0 21,8 V L +S +C		
	108 CDI 108 CDI BE 109 CDI 109 CDI BE	55 55 66 66		09.12 09.12 09.12 09.12	+ light alloy rims <sup>4)</sup> + light alloy rims <sup>4)</sup> + light alloy rims <sup>4)</sup> + light alloy rims <sup>4)</sup>	G2124222	+ 15"/16" wheel <sup>5)</sup>	280 24,0 21,8 V L +S +C		
	108 CDI 108 CDI BE 109 CDI 109 CDI BE	55 55 66 66		09.12 09.12 09.12 09.12		G1020874	+ 15"/16" wheel <sup>5)</sup>	24692 15,9 /Acc/S	LUC	
<b>MERCEDES BENZ C-Class (W202) Saloon (93-00)</b>										
	C 180 C 200 C 200 CDI C 200 D C 220 C 220 CDI C 220 D C 230 C 250 D C 280 C 280		F331440 A344660	03.93 01.94 03.98 03.93 03.93 09.97 06.93 07.96 06.93 06.93 06.93	05.00 05.00 05.00 05.00 08.96 05.00 05.00 06.97 08.95 05.00 05.00	G1020337		21439 20,3 /WD/S	LUC	
	C 200 Compressor C 230 Compressor C 240 C 250 TD C 280 C 280			10.95 09.95 06.97 09.95 05.00 05.00	05.00 05.00 05.00 05.00 05.00 05.00	G1020398		21664 19,8 +/WD	ATE	
	C 43 AMG			09.97	05.00	G1020683		21484 20,5 +/WD	ATE	
	C 200 Compressor C 230 Compressor C 240 C 250 TD C 280 C 280		F331441 A344661	10.95 09.95 06.97 09.95 05.00 05.00	05.00 05.00 05.00 05.00 05.00 05.00	G2125110		288 25,0 22,4 V L +S +C		
	C 180 C 180 C 200 C 200 C 200 D C 200 D C 220 C 220 C 220 D C 220 D C 250 D C 250 D C 280 C 280		F443892 A419828 F443892 A419828 F443892 A419828 F443892 A419828 F443892 A419828 F443892 A419828 F331440 A344660	03.93 03.93 01.94 01.94 03.93 03.93 03.93 03.93 06.93 06.93 06.93 06.93 06.93 06.93			G1020046		20687 15,5	ATE
	C 180 C 180 C 200 C 200 C 200 CDI C 200 D C 200 D C 220 C 220		F443893 A419829 F443893 A419829 F443893 A419829 F443893 A419829	05.00 05.00 05.00 05.00 05.00 05.00 05.00 08.96 08.96			G1020422		21900 15,0	ATE

<sup>1)</sup> + cerchi in acciaio / + jantes en acier / + Llantas acero / + Stahlfelgen

<sup>2)</sup> + ruota 14" / + roue 14" / + rueda 14" / + 14" Rad

<sup>3)</sup> + ruota 15" / + roue 15" / + rueda 15" / + 15" Rad

<sup>4)</sup> + cerchi in lega / + jantes en alliage léger / + Llantas de aleación ligera / + Leichtmetalfelgen

<sup>5)</sup> + ruota 15"/16" / + roue 15"/16" / + rueda 15"/16" / + 15"/16" Rad















**MERCEDES BENZ C-Class (W202) Saloon (93-00)**

	C 220 CDI			09.97	05.00	G1020422		21900 15,0	ATE				
	C 220 D	F443893			05.00								
	C 220 D	A419829			05.00								
	C 230			07.96	06.97								
	C 250 D	F443893			08.95								
	C 250 D	A419829			08.95								
	C 200 Compressor		F576240	10.95						G1020339		21197 15,0 /WD	ATE
	C 200 Compressor		A487047	10.95									
	C 230 Compressor		F576240	09.95									
	C 230 Compressor		A487047	09.95									
C 240		F576240	06.97										
C 240		A487047	06.97										
C 250 TD		F576240	09.95										
C 250 TD		A487047	09.95										
C 280	142 F331441			05.97 - ASR/ - ETS									
C 280	142 A344661			05.97 - ASR/ - ETS									
C 280	145	F576240	06.97										
C 280	145	A487047	06.97										
C 36 AMG		F331440	05.94										
C 36 AMG		A344660	05.94										
C 200 Compressor		F576241	05.00		G1020441		21919 15,3 /Acc	ATE					
C 200 Compressor		A487048	05.00										
C 230 Compressor		F576241	05.00										
C 230 Compressor		A487048	05.00										
C 240		F576241	05.00										
C 240		A487048	05.00										
C 250 TD		F576241	05.00										
C 250 TD		A487048	05.00										
C 280	145 F576241		05.00										
C 280	145 A487048		05.00										
C 36 AMG		F331441	08.97		G1020400		21305 16,1 /WD	ATE					
C 36 AMG		A344661	08.97										
C 43 AMG			09.97	05.00									
	C 180			03.93	05.00	G2109120		258 9,0 7,3 +S +C					
	C 200			01.94	05.00								
	C 200 CDI			03.98	05.00								
	C 200 D			03.93	05.00								
	C 220			03.93	08.96								
	C 220 CDI			09.97	05.00								
	C 220 D			06.93	05.00								
	C 230			07.96	06.97								
	C 250 D			06.93	08.95								
	C 280	142	F331440	06.93									
	C 280	142	A344660	06.93									
	C 200 Compressor			10.95	05.00					G2109114		278 9,0 7,3 +S +C	
	C 230 Compressor			09.95	05.00								
	C 240			06.97	05.00								
	C 250 TD			09.95	05.00								
	C 280	142 F331441		05.97									
	C 280	142 A344661		05.97									
C 280	145		06.97	05.00									
C 36 AMG		F331441	08.97		G2110217		290 10,0 8,3 +S +C						
C 36 AMG		A344661	08.97										

**MERCEDES BENZ C-Class (S202) Estate (96-01)**

	C 180			06.96	04.01	G1020337		21439 20,3 /WD/S	LUC					
	C 200			06.96	04.01									
	C 200 CDI			03.98	04.01									
	C 200 D			07.96	04.01									
	C 220 CDI			09.97	04.01									
	C 220 D			06.96	04.01									
	C 230			06.96	06.97									
	C 200 Compressor			11.96	04.01					G1020398		21664 19,8 +/WD	ATE	
	C 230 Compressor			06.97	04.01									
	C 240			06.97	04.01									
C 250 TD			06.96	04.01										
C 280			06.97	04.01										
C 43 AMG			09.97	04.01										
C 200 Compressor			11.96	04.01	G1020683		21484 20,5 +/WD	ATE						
C 230 Compressor			06.97	04.01										
	C 240			06.97	04.01	G2125110		288 25,0 22,4 V L +S +C						
	C 250 TD			06.96	04.01									
	C 280			06.97	04.01									
		C 180		F576240	06.96						G1020339		21197 15,0 /WD	ATE
		C 200		F576240	06.96									
		C 200 CDI		F576240	03.98									
C 200 Compressor			F576240	11.96										
C 200 D			F576240	07.96										
C 220 CDI			F576240	09.97										
C 220 D			F576240	06.96										
C 230			F576240	06.96										
C 250 TD		F576240	06.96											
	C 180		F576241	04.01		G1020441		21919 15,3 /Acc	ATE					
	C 200		F576241	04.01										
	C 200 CDI		F576241	04.01										
	C 200 Compressor		F576241	04.01										

       									
<b>MERCEDES BENZ C-Class (S202) Estate (96-01)</b>									
	C 200 D F576241 C 220 CDI F576241 C 220 D F576241 C 230 F576241 C 230 Compressor 06.97 C 240 06.97 C 250 TD F576241 C 280 06.97 C 43 AMG 09.97	04.01 04.01 04.01 06.97 06.97 04.01 04.01 06.97 04.01			G1020441		21919 15,3 /Acc	ATE	
	C 180 C 200 C 200 CDI C 200 Compressor C 200 D C 220 CDI C 220 D C 230 C 230 Compressor C 240 C 250 TD C 280		06.96 06.96 03.98 11.96 07.96 09.97 06.96 06.96 06.97 06.97 06.96 06.97	04.01 04.01 04.01 04.01 04.01 04.01 04.01 06.97 04.01 04.01 04.01 04.01		G1020400 G2109114		21305 16,1 /WD 278 9,0 7,3 +S +C	ATE
<b>MERCEDES BENZ C-Class (W203) Saloon (00-07)</b>									
	C 180 C 180 Compressor C 200 CDI 90 C 200 CDI C 200 CGI Compressor C 200 Compressor C 200 Kompressor 120 C 220 CDI C 220 CDI 110		04.00 05.02 04.00 04.03 07.03 04.00 05.00 04.00 02.04	04.07 04.07 04.07 04.07 04.07 04.07 05.02 04.07 04.07	- sport package/- sport package AMG <sup>1)</sup> - sport package/- sport package AMG <sup>1)</sup> - sport package/- sport package AMG <sup>1)</sup> - sport package/- sport package AMG <sup>1)</sup> - sport package/- sport package AMG <sup>1)</sup> - sport package/- sport package AMG <sup>1)</sup>	G1020924		23144 19,8 +/WD/Acc/S	LUC
	C 180 Compressor C 200 CDI 90 C 200 CDI C 200 CGI Compressor C 200 Compressor C 220 CDI C 220 CDI 110 C 230 Compressor C 240 C 270 CDI C 320	A 660226 / F 565688 A 660226 / F 565688 A 660226 / F 565688 A 660226 / F 565688 A 660226 / F 565688 A 660226 / F 565688 A 660226 / F 565688 A 660226 / F 565688	05.02 04.00 04.03 07.03 04.00 04.00 02.04 02.04 04.00 08.00 04.00	04.07 04.07 04.07 04.07 04.07 04.07 04.07 04.07 04.07 04.07 04.07	+ sports package/+ sports package AMG <sup>2)</sup> + sports package/+ sports package AMG <sup>2)</sup> + sports package/+ sports package AMG <sup>2)</sup> + sports package/+ sports package AMG <sup>2)</sup> + sports package/+ sports package AMG <sup>2)</sup> + sports package/+ sports package AMG <sup>2)</sup> + sports package/+ sports package AMG <sup>2)</sup> + sports package/+ sports package AMG <sup>2)</sup> + sports package/+ sports package AMG <sup>2)</sup> + sports package/+ sports package AMG <sup>2)</sup> + sports package/+ sports package AMG <sup>2)</sup>	G1020677		23745 17,6 +/WD(1,8/7,1)	BRE
	C 180 Compressor C 200 CDI 90 C 200 CGI Compressor C 200 Compressor C 220 CDI C 230 C 230 Compressor C 240 C 270 CDI C 280 C 280 4-matic C 320 C 320 CDI C 350	A 660227 / F 565689 A 660227 / F 565689 A 660227 / F 565689 A 660227 / F 565689 A 660227 / F 565689 A 660227 / F 565689 A 660227 / F 565689 A 660227 / F 565689 A 660227 / F 565689 A 660227 / F 565689 A 660227 / F 565689	04.07 04.07 04.07 04.07 04.07 06.05 04.07 04.07 04.07 04.07 06.05 04.07 04.07 02.05 06.05	04.07 04.07 04.07 04.07 04.07 04.07 04.07 04.07 04.07 04.07 04.07 04.07 04.07 04.07 04.07	+ sports package/+ sports package AMG <sup>2)</sup> + sports package/+ sports package AMG <sup>2)</sup> + sports package/+ sports package AMG <sup>2)</sup> + sports package/+ sports package AMG <sup>2)</sup> + sports package/+ sports package AMG <sup>2)</sup> + sports package/+ sports package AMG <sup>2)</sup> + sports package/+ sports package AMG <sup>2)</sup> + sports package/+ sports package AMG <sup>2)</sup> + sports package/+ sports package AMG <sup>2)</sup> + sports package/+ sports package AMG <sup>2)</sup> + sports package/+ sports package AMG <sup>2)</sup> + sports package/+ sports package AMG <sup>2)</sup> + sports package/+ sports package AMG <sup>2)</sup> + sports package/+ sports package AMG <sup>2)</sup> + sports package/+ sports package AMG <sup>2)</sup>	G1020659		23945 16,5 /WD	BRE
	C 230 C 230 Compressor C 240 C 240 4-matic C 270 CDI C 280 C 280 4-matic C 320 C 320 4-matic		06.05 02.04 04.00 07.02 08.00 06.05 06.05 04.00 07.02	04.07 04.07 04.07 04.07 04.07 04.07 04.07 04.07 04.07	- sport package/- sport package AMG <sup>1)</sup> - sport package/- sport package AMG <sup>1)</sup> - sport package/- sport package AMG <sup>1)</sup> - sport package/- sport package AMG <sup>1)</sup> - sport package/- sport package AMG <sup>1)</sup> - sport package/- sport package AMG <sup>1)</sup> - sport package/- sport package AMG <sup>1)</sup> - sport package/- sport package AMG <sup>1)</sup> - sport package/- sport package AMG <sup>1)</sup>	G1020925		23144 19,8 +/WD/Acc/S	LUC
	C 30 CDI AMG C 320 CDI C 350 C 350 4-matic		01.03 02.05 06.05 06.05	04.07 04.07 04.07 04.07	+ sports package/+ sports package AMG <sup>2)</sup> + sports package/+ sports package AMG <sup>2)</sup>	G1020677		23745 17,6 +/WD(1,8/7,1)	BRE
	C 32 AMG Compressor C 55 AMG		03.01 02.04	04.07 04.07		G1020677		23745 17,6 +/WD(1,8/7,1)	BRE
	C 180 C 180 Compressor C 200 CDI 90 C 200 CDI C 200 CGI Compressor C 200 Compressor C 200 Kompressor 120 C 220 CDI C 220 CDI 110		04.00 05.02 04.00 04.03 07.03 04.00 05.00 04.00 02.04	04.07 04.07 04.07 04.07 04.07 04.07 05.02 04.07 04.07	- sport package/- sport package AMG <sup>1)</sup> - sport package/- sport package AMG <sup>1)</sup> - sport package/- sport package AMG <sup>1)</sup> - sport package/- sport package AMG <sup>1)</sup> - sport package/- sport package AMG <sup>1)</sup> - sport package/- sport package AMG <sup>1)</sup> - sport package/- sport package AMG <sup>1)</sup>	G2125110		288 25,0 22,4 V L +S +C	
	C 180 Compressor C 200 CDI 90 C 200 CDI C 200 CGI Compressor C 200 Compressor		05.02 04.00 04.03 07.03 04.00	04.07 04.07 04.07 04.07 04.07	+ sports package/+ sports package AMG <sup>2)</sup> + sports package/+ sports package AMG <sup>2)</sup> + sports package/+ sports package AMG <sup>2)</sup> + sports package/+ sports package AMG <sup>2)</sup> + sports package/+ sports package AMG <sup>2)</sup>	G2128177		330 28,0 26,0 V L +C	

<sup>1)</sup> - pacchetto sportivo/- pacchetto sport.AMG / - version sport/- version sport AMG / - kit sportivo/- kit sportivo AMG / - Sportpaket / - Sportpaket AMG  
<sup>2)</sup> + pacchetto sportivo/+ pacchetto sport.AMG / + version sport/+ version sport AMG / + kit sportivo/+ kit sportivo AMG / + Sportpaket / + Sportpaket AMG



**MERCEDES BENZ C-Class (W203) Saloon (00-07)**

	C 220 CDI C 220 CDI C 230 C 230 Compressor C 240 C 270 CDI C 280 C 280 4-matic C 320	110		04.00 02.04 06.05 02.04 04.00 08.00 06.05 06.05 04.00	04.07 04.07 04.07 04.07 04.07 04.07 04.07 04.07 04.07	+ sports package/+ sports package AMG <sup>1)</sup> + sports package/+ sports package AMG <sup>1)</sup> + sports package/+ sports package AMG <sup>1)</sup> + sports package/+ sports package AMG <sup>1)</sup> + sports package/+ sports package AMG <sup>1)</sup> + sports package/+ sports package AMG <sup>1)</sup> + sports package/+ sports package AMG <sup>1)</sup> + sports package/+ sports package AMG <sup>1)</sup> + sports package/+ sports package AMG <sup>1)</sup>	G2128177		330 28,0 26,0 V L +C	
	C 180 C 180 Compressor C 200 CDI C 200 CDI C 200 CGI Compressor C 200 Compressor C 200 Kompressor C 220 CDI C 220 CDI	90 120 110		04.00 05.02 04.00 04.03 07.03 04.00 05.00 04.00 02.04	04.07 04.07 04.07 04.07 04.07 04.07 05.02 04.07 04.07	- sport package/- sport package AMG <sup>2)</sup> - sport package/- sport package AMG <sup>2)</sup> - sport package/- sport package AMG <sup>2)</sup> - sport package/- sport package AMG <sup>2)</sup> - sport package/- sport package AMG <sup>2)</sup> - sport package/- sport package AMG <sup>2)</sup> - sport package/- sport package AMG <sup>2)</sup> - sport package/- sport package AMG <sup>2)</sup> - sport package/- sport package AMG <sup>2)</sup>	G1020441		21919 15,3 /Acc	ATE
	C 180 Compressor C 200 CDI C 200 CDI C 200 CGI Compressor C 200 Compressor C 220 CDI C 220 CDI C 230 C 230 Compressor C 240 C 240 4-matic C 270 CDI C 280 C 280 4-matic C 320 C 320 4-matic C 320 CDI C 350 C 350 4-matic	90 110		05.02 04.00 04.03 07.03 04.00 04.00 02.04 06.05 02.04 04.00 07.02 08.00 06.05 06.05 04.00 07.02 02.05 06.05 06.05	04.07 04.07 04.07 04.07 04.07 04.07 04.07 04.07 04.07 04.07 04.07 04.07 04.07 04.07 04.07 04.07 04.07 04.07 04.07	+ sports package/+ sports package AMG <sup>1)</sup> + sports package/+ sports package AMG <sup>1)</sup> + sports package/+ sports package AMG <sup>1)</sup> + sports package/+ sports package AMG <sup>1)</sup> + sports package/+ sports package AMG <sup>1)</sup> + sports package/+ sports package AMG <sup>1)</sup> + sports package/+ sports package AMG <sup>1)</sup> + sports package/+ sports package AMG <sup>1)</sup> + sports package/+ sports package AMG <sup>1)</sup> + sports package/+ sports package AMG <sup>1)</sup> + sports package/+ sports package AMG <sup>1)</sup> + sports package/+ sports package AMG <sup>1)</sup> + sports package/+ sports package AMG <sup>1)</sup> + sports package/+ sports package AMG <sup>1)</sup> + sports package/+ sports package AMG <sup>1)</sup> + sports package/+ sports package AMG <sup>1)</sup> + sports package/+ sports package AMG <sup>1)</sup> + sports package/+ sports package AMG <sup>1)</sup> + sports package/+ sports package AMG <sup>1)</sup>	G1020442		21899 15,3 /WD/Acc	ATE
	C 30 CDI AMG C 32 AMG Compressor C 55 AMG			01.03 03.01 02.04	04.07 04.07 04.07		G1020400		21305 16,1 /WD	ATE
	C 180 C 180 Compressor C 200 CDI C 200 CDI C 200 CGI Compressor C 200 Compressor C 200 Kompressor C 220 CDI C 220 CDI C 230	90 120 110		04.00 05.02 04.00 04.03 07.03 04.00 05.00 04.00 02.04 06.05	04.07 04.07 04.07 04.07 04.07 04.07 05.02 04.07 04.07 04.07	- sport package/- sport package AMG <sup>2)</sup> - sport package/- sport package AMG <sup>2)</sup> - sport package/- sport package AMG <sup>2)</sup> - sport package/- sport package AMG <sup>2)</sup> - sport package/- sport package AMG <sup>2)</sup> - sport package/- sport package AMG <sup>2)</sup> - sport package/- sport package AMG <sup>2)</sup> - sport package/- sport package AMG <sup>2)</sup> - sport package/- sport package AMG <sup>2)</sup> - sport package/- sport package AMG <sup>2)</sup>	G2109114		278 9,0 7,3 +S +C	
	C 180 Compressor C 200 CDI C 200 CDI C 200 CGI Compressor C 200 Compressor C 220 CDI C 220 CDI C 230 C 230 Compressor C 240 C 240 4-matic C 270 CDI C 280 C 280 4-matic C 320 C 320 4-matic C 320 CDI C 350 C 350 4-matic	90 110		05.02 04.00 04.03 07.03 04.00 04.00 02.04 06.05 02.04 04.00 07.02 08.00 06.05 06.05 04.00 07.02 02.05 06.05 06.05	04.07 04.07 04.07 04.07 04.07 04.07 04.07 04.07 04.07 04.07 04.07 04.07 04.07 04.07 04.07 04.07 04.07 04.07 04.07	+ sports package/+ sports package AMG <sup>1)</sup> + sports package/+ sports package AMG <sup>1)</sup> + sports package/+ sports package AMG <sup>1)</sup> + sports package/+ sports package AMG <sup>1)</sup> + sports package/+ sports package AMG <sup>1)</sup> + sports package/+ sports package AMG <sup>1)</sup> + sports package/+ sports package AMG <sup>1)</sup> + sports package/+ sports package AMG <sup>1)</sup> + sports package/+ sports package AMG <sup>1)</sup> + sports package/+ sports package AMG <sup>1)</sup> + sports package/+ sports package AMG <sup>1)</sup> + sports package/+ sports package AMG <sup>1)</sup> + sports package/+ sports package AMG <sup>1)</sup> + sports package/+ sports package AMG <sup>1)</sup> + sports package/+ sports package AMG <sup>1)</sup> + sports package/+ sports package AMG <sup>1)</sup> + sports package/+ sports package AMG <sup>1)</sup> + sports package/+ sports package AMG <sup>1)</sup> + sports package/+ sports package AMG <sup>1)</sup>	G2110217		290 10,0 8,3 +S +C	

**MERCEDES BENZ C-Class (S203) Estate (01-07)**

	C 180 C 180 Compressor C 200 CDI C 200 CDI C 200 CGI Compressor C 200 Compressor C 200 Kompressor C 220 CDI C 220 CDI	90 120 110		03.01 05.02 03.01 04.03 07.03 05.02 03.01 03.01 02.04	09.07 09.07 09.07 09.07 09.07 09.07 04.02 09.07 09.07	- sport package/- sport package AMG <sup>2)</sup> - sport package/- sport package AMG <sup>2)</sup> - sport package/- sport package AMG <sup>2)</sup> - sport package/- sport package AMG <sup>2)</sup> - sport package/- sport package AMG <sup>2)</sup> - sport package/- sport package AMG <sup>2)</sup> - sport package/- sport package AMG <sup>2)</sup> - sport package/- sport package AMG <sup>2)</sup> - sport package/- sport package AMG <sup>2)</sup>	G1020924		23144 19,8 +WD/Acc/S	LUC
	C 180 Compressor C 200 CDI C 200 CDI C 200 CGI Compressor C 200 Compressor C 220 CDI C 220 CDI	90 110	A 660226 / F 565688 A 660226 / F 565688 A 660226 / F 565688 A 660226 / F 565688 A 660226 / F 565688	05.02 03.01 04.03 07.03 05.02 03.01 02.04	09.07 09.07 09.07 09.07 09.07 09.07 09.07	+ sports package/+ sports package AMG <sup>1)</sup> + sports package/+ sports package AMG <sup>1)</sup> + sports package/+ sports package AMG <sup>1)</sup> + sports package/+ sports package AMG <sup>1)</sup> + sports package/+ sports package AMG <sup>1)</sup> + sports package/+ sports package AMG <sup>1)</sup> + sports package/+ sports package AMG <sup>1)</sup>	G1020677		23745 17,6 +WD(1,8/7,1)	BRE

<sup>1)</sup> + pacchetto sportivo/+ pacchetto sport.AMG / + version sport/+ version sport AMG / + kit sportivo/+ kit sportivo AMG / + Sportpaket / + Sportpaket AMG  
<sup>2)</sup> - pacchetto sportivo/- pacchetto sport.AMG / - version sport/- version sport AMG / - kit sportivo/- kit sportivo AMG / - Sportpaket / - Sportpaket AMG







**MERCEDES BENZ C-Class (S203) Estate (01-07)**

	C 240		A 660226 / F 565688	03.01	09.07	+ sports package/+ sports package AMG <sup>1)</sup>	G1020677		23745 17,6 +WD(1,8/7,1)	BRE
	C 270 CDI		A 660226 / F 565688	03.01	09.07	+ sports package/+ sports package AMG <sup>1)</sup>				
	C 320		A 660226 / F 565688	03.01	09.07	+ sports package/+ sports package AMG <sup>1)</sup>				
	C 30 CDI AMG			01.03	09.07	+ sports package/+ sports package AMG <sup>1)</sup>	G1020677		23745 17,6 +WD(1,8/7,1)	BRE
	C 320 CDI			02.05	09.07	+ sports package/+ sports package AMG <sup>1)</sup>				
	C 350			06.05	09.07	+ sports package/+ sports package AMG <sup>1)</sup>				
	C 350 4-matic			06.05	09.07	+ sports package/+ sports package AMG <sup>1)</sup>				
	C 180 Compressor	90	A 660227 / F 565689		09.07	+ sports package/+ sports package AMG <sup>1)</sup>				
	C 200 CDI		A 660227 / F 565689		09.07	+ sports package/+ sports package AMG <sup>1)</sup>				
	C 200 CGI Compressor		A 660227 / F 565689		09.07	+ sports package/+ sports package AMG <sup>1)</sup>				
	C 200 Compressor		A 660227 / F 565689		09.07	+ sports package/+ sports package AMG <sup>1)</sup>				
	C 220 CDI	110	A 660227 / F 565689		09.07	+ sports package/+ sports package AMG <sup>1)</sup>				
	C 230			06.05	09.07	+ sports package/+ sports package AMG <sup>1)</sup>				
	C 230 Compressor			02.04	09.07	+ sports package/+ sports package AMG <sup>1)</sup>				
	C 240		A 660227 / F 565689		09.07	+ sports package/+ sports package AMG <sup>1)</sup>				
	C 270 CDI		A 660227 / F 565689		09.07	+ sports package/+ sports package AMG <sup>1)</sup>				
C 280			06.05	09.07	+ sports package/+ sports package AMG <sup>1)</sup>					
C 280 4-matic			06.05	09.07	+ sports package/+ sports package AMG <sup>1)</sup>					
C 320		A 660227 / F 565689		09.07	+ sports package/+ sports package AMG <sup>1)</sup>					
C 320 CDI			02.05	09.07	- sport package/- sport package AMG <sup>2)</sup>					
C 350			06.05	09.07	- sport package/- sport package AMG <sup>2)</sup>					
	C 230			06.05	09.07	- sport package/- sport package AMG <sup>2)</sup>	G1020925		23144 19,8 +WD/Acc/S	LUC
	C 230 Compressor			02.04	09.07	- sport package/- sport package AMG <sup>2)</sup>				
	C 240			03.01	09.07	- sport package/- sport package AMG <sup>2)</sup>				
	C 240 4-matic			07.02	09.07	- sport package/- sport package AMG <sup>2)</sup>				
	C 270 CDI			03.01	09.07	- sport package/- sport package AMG <sup>2)</sup>				
	C 280			06.05	09.07	- sport package/- sport package AMG <sup>2)</sup>				
	C 280 4-matic			06.05	09.07	- sport package/- sport package AMG <sup>2)</sup>				
	C 320			03.01	09.07	- sport package/- sport package AMG <sup>2)</sup>				
	C 320 4-matic			07.02	09.07	- sport package/- sport package AMG <sup>2)</sup>				
	C 32 Compressor AMG			03.01	09.07					
	C 55 AMG			02.04	09.07					
	C 180			03.01	09.07		G2125110		288 25,0 22,4 V L +S +C	
	C 180 Compressor			05.02	09.07	- sport package/- sport package AMG <sup>2)</sup>				
	C 200 CDI	90		03.01	09.07	- sport package/- sport package AMG <sup>2)</sup>				
	C 200 CDI			04.03	09.07	- sport package/- sport package AMG <sup>2)</sup>				
	C 200 CGI Compressor			07.03	09.07	- sport package/- sport package AMG <sup>2)</sup>				
	C 200 Compressor			05.02	09.07	- sport package/- sport package AMG <sup>2)</sup>				
	C 200 Kompressor	120		03.01	04.02					
	C 220 CDI			03.01	09.07	- sport package/- sport package AMG <sup>2)</sup>				
	C 220 CDI	110		02.04	09.07	- sport package/- sport package AMG <sup>2)</sup>				
	C 180 Compressor			05.02	09.07	+ sports package/+ sports package AMG <sup>1)</sup>				
	C 200 CDI	90		03.01	09.07	+ sports package/+ sports package AMG <sup>1)</sup>				
	C 200 CDI			04.03	09.07	+ sports package/+ sports package AMG <sup>1)</sup>				
	C 200 CGI Compressor			07.03	09.07	+ sports package/+ sports package AMG <sup>1)</sup>				
C 200 Compressor			05.02	09.07	+ sports package/+ sports package AMG <sup>1)</sup>					
C 220 CDI			03.01	09.07	+ sports package/+ sports package AMG <sup>1)</sup>					
C 220 CDI	110		02.04	09.07	+ sports package/+ sports package AMG <sup>1)</sup>					
C 230			06.05	09.07	+ sports package/+ sports package AMG <sup>1)</sup>					
C 230 Compressor			02.04	09.07	+ sports package/+ sports package AMG <sup>1)</sup>					
C 240			03.01	09.07	+ sports package/+ sports package AMG <sup>1)</sup>					
C 270 CDI			03.01	09.07	+ sports package/+ sports package AMG <sup>1)</sup>					
C 280			06.05	09.07	+ sports package/+ sports package AMG <sup>1)</sup>					
C 280 4-matic			06.05	09.07	+ sports package/+ sports package AMG <sup>1)</sup>					
C 320			03.01	09.07	+ sports package/+ sports package AMG <sup>1)</sup>					
	C 180			03.01	09.07		G1020442		21899 15,3 /WD/Acc	ATE
	C 180 Compressor			05.02	09.07					
	C 200 CDI	90		03.01	09.07					
	C 200 CDI			04.03	09.07					
	C 200 CGI Compressor			07.03	09.07					
	C 200 Compressor			05.02	09.07					
	C 200 Kompressor	120		03.01	04.02					
	C 220 CDI			03.01	09.07					
	C 220 CDI	110		02.04	09.07					
	C 230			06.05	09.07					
	C 230 Compressor			02.04	09.07					
	C 240			03.01	09.07					
	C 240 4-matic			07.02	09.07					
	C 270 CDI			03.01	09.07					
	C 280			06.05	09.07					
	C 280 4-matic			06.05	09.07					
	C 320			03.01	09.07					
	C 320 4-matic			07.02	09.07					
	C 320 CDI			02.05	09.07					
	C 350			06.05	09.07					
C 350 4-matic			06.05	09.07	+ sports package/+ sports package AMG <sup>1)</sup>					
C 30 CDI AMG			01.03	09.07						
C 32 Compressor AMG			03.01	09.07						
C 350 4-matic			06.05	09.07	- sport package/- sport package AMG <sup>2)</sup>					
C 55 AMG			02.04	09.07						
	C 180			03.01	09.07		G2110217		290 10,0 8,3 +S +C	
	C 180 Compressor			05.02	09.07					
	C 200 CDI	90		03.01	09.07					
	C 200 CDI			04.03	09.07					
	C 200 CGI Compressor			07.03	09.07					
C 200 Compressor			05.02	09.07						

<sup>1)</sup> + pacchetto sportivo/+ pacchetto sport.AMG / + version sport/+ version sport AMG / + kit sportivo/+ kit sportivo AMG / + Sportpaket / + Sportpaket AMG

<sup>2)</sup> - pacchetto sportivo/- pacchetto sport.AMG / - version sport/- version sport AMG / - kit sportivo/- kit sportivo AMG / - Sportpaket / - Sportpaket AMG



MERCEDES BENZ C-Class (S203) Estate (01-07)									
	C 200 Kompressor	120		03.01	04.02		G2110217		290 10,0 8,3 +S +C
	C 220 CDI			03.01	09.07				
	C 220 CDI	110		02.04	09.07				
	C 230			06.05	09.07				
	C 230 Compressor			02.04	09.07				
	C 240			03.01	09.07				
	C 240 4-matic			07.02	09.07				
	C 270 CDI			03.01	09.07				
	C 280			06.05	09.07				
	C 280 4-matic			06.05	09.07				
	C 320			03.01	09.07				
	C 320 4-matic			07.02	09.07				
	C 320 CDI			02.05	09.07				
	C 350			06.05	09.07				
	C 350 4-matic			06.05	09.07	+ sports package/+ sports package AMG <sup>1)</sup>			

MERCEDES BENZ C-Class (CL203) Sportcoupe (01-08)									
	C 160 Compressor			04.05	05.08		G1020924		23144 19,8 +/WD/Acc/S LUC
	C 180			03.01	05.08				
	C 180 Compressor			05.02	05.08				
	C 200 CDI			07.03	05.08				
	C 200 CGI Compressor			07.03	05.08				
	C 200 Compressor			03.01	05.08				
	C 220 CDI			03.01	05.08				
	C 230 Compressor			03.01	05.08		G1020925 G1020924		23144 19,8 +/WD/Acc/S LUC 23144 19,8 +/WD/Acc/S LUC
	C 230			06.05	05.08		G1020925		23144 19,8 +/WD/Acc/S LUC
	C 320			09.02	05.08				
C 350			06.05	05.08		G1020659		23945 16,5 /WD BRE	
C 30 CDI AMG			09.02	05.08		G1020677		23745 17,6 +/WD(1,8/7,1) BRE	
	C 160 Compressor			04.05	05.08		G2125110		288 25,0 22,4 V L +S +C
	C 180			03.01	05.08				
	C 180 Compressor			05.02	05.08				
	C 200 CDI			07.03	05.08				
	C 200 CGI Compressor			07.03	05.08				
	C 200 Compressor			03.01	05.08				
	C 220 CDI			03.01	05.08				
	C 230 Compressor			03.01	05.08		G2125110	+ AUS J USA	288 25,0 22,4 V L +S +C
	C 160 Compressor			04.05	05.08		G1020441		21919 15,3 /Acc ATE
	C 180			03.01	05.08				
C 180 Compressor			05.02	05.08					
C 200 CDI			07.03	05.08					
C 200 CGI Compressor			07.03	05.08					
C 200 Compressor			03.01	05.08					
C 220 CDI			03.01	05.08					
C 230 Compressor			03.01	05.08		G1020442 G1020441	+ AUS J USA	21899 15,3 /WD/Acc ATE 21919 15,3 /Acc ATE	
C 230			06.05	05.08		G1020442		21899 15,3 /WD/Acc ATE	
C 30 CDI AMG	A 556572		09.02	05.08					
C 320			09.02	05.08					
C 350			06.05	05.08					
C 30 CDI AMG	A 556573			05.08		G1020400		21305 16,1 /WD ATE	
	C 160 Compressor			04.05	05.08		G2109114		278 9,0 7,3 +S +C
	C 180			03.01	05.08				
	C 180 Compressor			05.02	05.08				
	C 200 CDI			07.03	05.08				
	C 200 CGI Compressor			07.03	05.08				
	C 200 Compressor			03.01	05.08				
	C 220 CDI			03.01	05.08				
	C 230			06.05	05.08		G2110217		290 10,0 8,3 +S +C
	C 230 Compressor			03.01	05.08		G2110217 G2109114	+ AUS J USA	290 10,0 8,3 +S +C 278 9,0 7,3 +S +C
	C 320			09.02	05.08		G2110217		290 10,0 8,3 +S +C
C 350			06.05	05.08					
C 30 CDI AMG	A 556572		09.02			G2110217		290 10,0 8,3 +S +C	

MERCEDES BENZ C-Class (CLC203) Coupe (08-10)									
	CLC 160			01.09	10.10		G1020924		23144 19,8 +/WD/Acc/S LUC
	CLC 180 Compressor			05.08	10.10		G1020924		23144 19,8 +/WD/Acc/S LUC
	CLC 200 CDI			05.08	10.10				
	CLC 220 CDI			05.08	10.10				
	CLC 200 Compressor			05.08	10.10		G1020925		23144 19,8 +/WD/Acc/S LUC
	CLC 230			05.08	10.10				
CLC 350			05.08	10.10		G1020659		23945 16,5 /WD BRE	
	CLC 160			01.09	10.10		G2125110		288 25,0 22,4 V L +S +C
	CLC 180 Compressor			05.08	10.10				
	CLC 200 CDI			05.08	10.10				
	CLC 220 CDI			05.08	10.10				
	CLC 160			01.09	10.10		G1020441		21919 15,3 /Acc ATE
	CLC 180 Compressor			05.08	10.10				
	CLC 200 CDI			05.08	10.10				
	CLC 220 CDI			05.08	10.10				
CLC 200 Compressor			05.08	10.10		G1020442		21899 15,3 /WD/Acc ATE	

<sup>1)</sup> + pacchetto sportivo/+ pacchetto sport.AMG / + version sport/+ version sport AMG / + kit sportivo/+ kit sportivo AMG / + Sportpaket / + Sportpaket AMG





**MERCEDES BENZ C-Class (CLC203) Coupe (08-10)**















	CLC 230 CLC 350			05.08 05.08	10.10 10.10		G1020442		21899 15,3 /WD/Acc	ATE
	CLC 160 CLC 180 Compressor CLC 200 CDI CLC 220 CDI			01.09 05.08 05.08 05.08	10.10 10.10 10.10 10.10		G2109114 G2109114		278 9,0 7,3 +S +C 278 9,0 7,3 +S +C	
	CLC 200 Compressor CLC 230 CLC 350			05.08 05.08 05.08	10.10 10.10 10.10		G2110217		290 10,0 8,3 +S +C	

**MERCEDES BENZ C-Class (W204) Saloon (07-)**

	C 180 CDI C 180 CGI C 180 Compressor C 180 Compressor Eco C 200 CDI C 200 CGI	88 115 115		01.11 04.09 03.07 01.09			G1020933 G1020934	+ sports package <sup>1)</sup> - sports package <sup>2)</sup>	24306 20,3 /WD/Acc/S 24306 20,3 /WD/Acc/S	LUC LUC	
	C 200 Compressor C 220 CDI C 220 CDI C 220 CDI 4-matic C 230 C 230 4-matic C 250 CDI C 250 CDI 4-matic C 250 CGI	135 120 125 125 150 150 150 150 150		03.07 03.07 03.07 02.13 03.07 07.07 10.08 01.11 04.09			G1020933		24306 20,3 /WD/Acc/S	LUC	
	C 280 C 280 4-matic C 300	170 170 170		03.07 07.07 07.09			G1020933 G1020935	- sports package <sup>2)</sup> + sports package <sup>1)</sup>	24306 20,3 /WD/Acc/S 24310 19,0 + /WD/S	LUC LUC	
	C 300 4-matic C 300 CDI 4-matic	170 170		04.09 01.11			G1020933 G1020935	- sports package <sup>2)</sup> + sports package <sup>1)</sup>	24306 20,3 /WD/Acc/S 24310 19,0 + /WD/S	LUC LUC	
	C 300 CGI C 300 CGI 4-matic C 320 CDI C 320 CDI 4-matic C 350 C 350 C 350 4-matic C 350 4-matic C 350 CDI C 350 CDI C 350 CDI C 350 CDI 4-matic C 350 CDI 4-matic C 350 CGI	185 185 165 165 200 225 200 225 165 170 195 165 170 170 215		02.11 02.11 03.07 07.07 03.07 01.11 07.07 01.11 04.09 10.09 06.11 07.09 10.09 09.08			G1020935		24310 19,0 + /WD/S	LUC	
	C 180 CDI C 180 CGI C 180 Compressor C 180 Compressor Eco C 200 CDI C 200 CGI C 200 Compressor C 220 CDI C 220 CDI C 220 CDI 4-matic C 230 C 230 4-matic C 250 CDI C 250 CDI 4-matic C 250 CGI C 280 C 280 4-matic C 300 C 300 4-matic C 300 CDI 4-matic C 300 CGI C 300 CGI 4-matic C 320 CDI C 320 CDI 4-matic C 350 C 350 C 350 4-matic C 350 4-matic C 350 CDI C 350 CDI C 350 CDI C 350 CDI 4-matic C 350 CDI 4-matic C 350 CGI	88 115 115 100 135 135 120 125 125 150 150 150 150 150 150 170 170 170 170 170 170 185 185 165 165 200 225 200 225 165 170 195 165 170 170 185 185 165 165 200 225 200 225 165 170 195 165 170 170 215		01.11 04.09 03.07 01.09 03.07 04.09 03.07 03.07 03.07 02.13 03.07 07.07 10.08 01.11 04.09 03.07 07.07 07.09 01.11 01.11 02.11 02.11 03.07 07.07 03.07 01.11 07.07 01.11 04.09 10.09 06.11 07.09 10.09 09.08				G1020963		24253 17,8 +/WD	ATE

<sup>1)</sup> + pacchetto sportivo / + version sport / + kit sportivo / + Sportpaket  
<sup>2)</sup> - pacchetto sport / - version sport / - paquete sportivo / - Sportpaket



									
<b>MERCEDES BENZ C-Class (S204) Estate (07-)</b>									
	C 180 CDI BE	88	01.11		G1020933		+ sports package <sup>1)</sup>	24306 20,3 /WD/Acc/S	LUC
	C 180 Compressor		09.07		G1020934		- sports package <sup>2)</sup>	24306 20,3 /WD/Acc/S	LUC
	C 200 CDI		09.07						
	C 180 CGI	115	04.09		G1020933			24306 20,3 /WD/Acc/S	LUC
	C 200 CGI		04.09						
	C 200 Compressor	135	09.07						
	C 220 CDI		09.07						
	C 220 CDI 4-matic	125	02.13						
	C 230	150	09.07						
	C 250 CDI	150	04.09						
	C 250 CGI	150	04.09						
	C 250 CDI 4matic	150	04.09		G1020933		- sports package <sup>2)</sup>	24306 20,3 /WD/Acc/S	LUC
	C 280	170	09.07		G1020935		+ sports package <sup>1)</sup>	24310 19,0 + /WD/S	LUC
	C 320 CDI	165	09.07		G1020935			24310 19,0 + /WD/S	LUC
C 320 CDI 4-matic	165	09.07							
C 350	200	09.07							
C 350 CDI	195	06.11							
C 350 CDI 4-matic	170	10.09							
C 350 CDI BlueEff.	170	04.09							
C 350 CGI	225	06.11		G1020935			24310 19,0 + /WD/S	LUC	
	C 180 CGI	115	04.09		G1020963			24253 17,8 +/WD	ATE
	C 180 Compressor		09.07						
	C 200 CDI		09.07						
	C 200 CGI		04.09						
	C 200 Compressor	135	09.07						
	C 220 CDI		09.07						
	C 220 CDI 4-matic	125	02.13						
	C 230	150	09.07						
	C 250 CGI	150	04.09						
	C 280	170	09.07						
	C 320 CDI	165	09.07						
	C 320 CDI 4-matic	165	09.07						
	C 350	200	09.07						
	C 350 CDI 4-matic	170	10.09						
C 350 CDI BlueEff.	170	04.09							
C 180 CDI BE	88	01.11		G1020963			24253 17,8 +/WD	ATE	
C 350 CGI	225	06.11		G1020963			24253 17,8 +/WD	ATE	
C 350 CDI	195	06.11		G1020963		+ aluminium calipers <sup>3)</sup>	24253 17,8 +/WD	ATE	
C 250 CDI 4matic	150	04.09		G1020963		+ sports package <sup>1)</sup>	24253 17,8 +/WD	ATE	
<b>MERCEDES BENZ C-Class (C204) Coupe (11-)</b>									
	C 180	115	01.13		G1020934		- sports package <sup>2)</sup>	24306 20,3 /WD/Acc/S	LUC
	C 180 CGI	115	06.11		G1020933		+ sports package <sup>1)</sup>	24306 20,3 /WD/Acc/S	LUC
	C 200 CGI	135	06.11		G1020933			24306 20,3 /WD/Acc/S	LUC
	C 220 CDI	125	06.11						
	C 250 CDI	150	06.11						
	C 250 CGI	150	06.11						
C 350	225	06.11		G1020935			24310 19,0 + /WD/S	LUC	
	C 180	115	01.13		G1020963			24253 17,8 +/WD	ATE
	C 180 CGI	115	06.11						
	C 200 CGI	135	06.11						
	C 220 CDI	125	06.11						
	C 250 CDI	150	06.11						
	C 250 CGI	150	06.11						
	C 350	225	06.11						
	C 350	225	06.11						
<b>MERCEDES BENZ CL-Class (C140) Coupe (96-99)</b>									
	CL 420		06.96	02.99	G1020400			21305 16,1 /WD	ATE
	CL 500		06.96	02.99					
	CL 600		06.96	02.99					
<b>MERCEDES BENZ CL-Class (C215) Coupe (99-06)</b>									
	CL 500		03.99	08.06	G1020574			23271 17,6 +/WD(1,8)	BRE
	CL 55 AMG		10.99	08.06					
	CL 600		03.99	08.06					
	CL 500		03.99	08.06	G2132115			330 32,0 30,0 V L +C	
<b>MERCEDES BENZ CL-Class (C216) Coupe (06-)</b>									
	CL 500	285	07.06		G1020877			23960 18,3 /WD	BRE
	CL 500 4-matic	285	03.08						
	CL 500	285	07.06		G1020652			23334 16,7 +/WD	ATE
	CL 500 4-matic	285	03.08						
<b>MERCEDES BENZ CLK-Class (C208) Coupe (97-02)</b>									
	CLK 200	100	06.97	06.02	G1020398			21664 19,8 +/WD	ATE
	CLK 200 Compressor	141	06.97	06.02					
	CLK 200 Kompressor	120	06.00	06.02					
	CLK 230 Compressor	142	06.97	06.02					
	CLK 230 Kompressor	145	06.00	06.02					
↓	CLK 320	160	06.97	06.02	G1020401			21670 19,4 +/WD	ATE

<sup>1)</sup> + pacchetto sportivo / + version sport / + kit deportivo / + Sportpaket

<sup>2)</sup> - paccho sport / - version sport / - paquete deportivo / - Sportpaket

<sup>3)</sup> + pinze in alluminio / + étriers en aluminium / + pinzas de aluminio / + ALU-Sättel





**MERCEDES BENZ CLK-Class (C209) Coupe (02-09)**

	CLK 280	170		05.05	04.09		G2128177	+ sport package / + sport package AMG <sup>1)</sup>	330 28,0 26,0 V L +C	
	CLK 200 CGI	125		09.02	04.09		G1020441	- sport package / - sport package AMG <sup>2)</sup>	21919 15,3 /Acc	ATE
	CLK 200 Compressor	120		09.02	04.09		G1020442	+ sport package / + sport package AMG <sup>1)</sup>	21899 15,3 /WD/Acc	ATE
	CLK 220 CDI			05.05	04.09					
	CLK 200 Kompressor	135		10.06	04.09		G1020442		21899 15,3 /WD/Acc	ATE
	CLK 240			05.02	04.09					
	CLK 270 CDI			10.02	04.09					
	CLK 280	170		05.05	04.09					
	CLK 320	160		05.02	04.09					
	CLK 320 CDI	165		05.05	04.09					
	CLK 350	200		05.05	04.09					
	CLK 500	225		05.02	04.09		G1020400		21305 16,1 /WD	ATE
	CLK 500	285		06.06	04.09					
	CLK 55 AMG	270	F 123374	09.02						
	CLK 200 CGI	125		09.02	04.09		G2109114	- sport package / - sport package AMG <sup>2)</sup>	278 9,0 7,3 +S +C	
	CLK 200 Compressor	120		09.02	04.09		G2110217	+ sport package / + sport package AMG <sup>1)</sup>	290 10,0 8,3 +S +C	
	CLK 220 CDI			05.05	04.09					
	CLK 200 Kompressor	135		10.06	04.09		G2110217		290 10,0 8,3 +S +C	
	CLK 240			05.02	04.09					
	CLK 270 CDI			10.02	04.09					
	CLK 280	170		05.05	04.09					
	CLK 320	160		05.02	04.09					
	CLK 320 CDI	165		05.05	04.09					
	CLK 350	200		05.05	04.09					

**MERCEDES BENZ CLK-Class (A209) Convertible (03-09)**















	CLK 200 CGI	125		05.03	12.09		G1020924		23144 19,8 +/WD/Acc/S	LUC
	CLK 240	125		05.03	12.09		G1020925		23144 19,8 +/WD/Acc/S	LUC
	CLK 320	160		05.03	12.09					
	CLK 200 Compressor	120		05.03	12.09		G1020925	- sport package / - sport package AMG <sup>2)</sup>	23144 19,8 +/WD/Acc/S	LUC
	CLK 200 Kompressor	135		10.06	12.09		G1020659	+ sport package / + sport package AMG <sup>1)</sup>	23945 16,5 /WD	BRE
	CLK 280	170		05.05	12.09					
	CLK 320 CDI	165		05.05	12.09		G1020659	- sport package / - sport package AMG <sup>2)</sup>	23945 16,5 /WD	BRE
	CLK 350	200		05.05	12.09		G1020677	+ sport package / + sport package AMG <sup>1)</sup>	23745 17,6 +/WD(1,8/7,1)	BRE
	CLK 500	225		05.03	12.09		G1020677		23745 17,6 +/WD(1,8/7,1)	BRE
	CLK 500	285		06.06	12.09					
	CLK 55 AMG	270	T 033979 / F 123374	05.03						
	CLK 200 CGI	125		05.03	12.09		G2125110		288 25,0 22,4 V L +S +C	
	CLK 200 Compressor	120		05.03	12.09		G2128177	+ sport package / + sport package AMG <sup>1)</sup>	330 28,0 26,0 V L +C	
	CLK 200 Kompressor	135		10.06	12.09					
	CLK 280	170		05.05	12.09					
	CLK 200 CGI	125		05.03	12.09		G1020441		21919 15,3 /Acc	ATE
	CLK 200 Compressor	120		05.03	12.09		G1020442		21899 15,3 /WD/Acc	ATE
	CLK 200 Kompressor	135		10.06	12.09					
	CLK 240	125		05.03	12.09					
	CLK 280	170		05.05	12.09					
	CLK 320	160		05.03	12.09					
	CLK 320 CDI	165		05.05	12.09					
	CLK 350	200		05.05	12.09					
	CLK 500	225		05.03	12.09		G1020400		21305 16,1 /WD	ATE
	CLK 500	285		06.06	12.09					
	CLK 55 AMG	270	T 033979 / F 123374	05.03						
	CLK 200 CGI	125		05.03	12.09		G2109114		278 9,0 7,3 +S +C	
	CLK 200 Compressor	120		05.03	12.09		G2110217		290 10,0 8,3 +S +C	
	CLK 200 Kompressor	135		10.06	12.09					
	CLK 240	125		05.03	12.09					
	CLK 280	170		05.05	12.09					
	CLK 320	160		05.03	12.09					
	CLK 320 CDI	165		05.05	12.09					
	CLK 350	200		05.05	12.09					

**MERCEDES BENZ CLS-Class (C219) Coupe (04-10)**

	CLS 280 / CLS 300	170		10.07	10.10		G1020677		23745 17,6 +/WD(1,8/7,1)	BRE
	CLS 320 CDI	155		05.05	10.10					
	CLS 320 CDI	165	A 038331	05.05						
	CLS 350	200		08.04	10.10					
	CLS 350 CDI	165		04.09	10.10					
	CLS 350 CGI	215		04.09	10.10					
	CLS 350 CGI	215		04.06	10.10					
	CLS 320 CDI	165	A 038332		10.10		G1020677		23745 17,6 +/WD(1,8/7,1)	BRE
	CLS 500	225		08.04	10.10		G1020677		23745 17,6 +/WD(1,8/7,1)	BRE
	CLS 500	285	A 069799	04.06			G1020877		23960 18,3 /WD	BRE
	CLS 500	285	A 069700		10.10		G1020877		23960 18,3 /WD	BRE
	CLS 320 CDI	155		05.05	10.10		G2128142		312 28,0 25,4 V L +C	
	CLS 320 CDI	165		05.05	10.10					
	CLS 350 CDI	165		04.09	10.10					
	CLS 280 / CLS 300	170		10.07	10.10		G2132144		330 32,0 29,4 V L +S +C	
	CLS 350	200		08.04	10.10					
	CLS 350 CGI	215		04.09	10.10					
	CLS 350 CGI	215		04.06	10.10					
	CLS 500	225		08.04	10.10					

<sup>1)</sup> + pacco sport/+ pacco sport AMG / + version sport / + version sport AMG / + paquete deportivo/+ paquete deportivo AMG / + Sportpaket / + Sportpaket AMG  
<sup>2)</sup> - pacco sport/- pacco sport AMG / - version sport / - version sport AMG / - paquete deportivo/- paquete deportivo AMG / - Sportpaket / - Sportpaket AMG



									
<b>MERCEDES BENZ CLS-Class (C219) Coupe (04-10)</b>									
	CLS 280 / CLS 300	170		10.07	10.10	G1020652		23334 16,7 +/WD	ATE
	CLS 320 CDI	155		05.05	10.10				
	CLS 320 CDI	165		05.05	10.10				
	CLS 350	200		08.04	10.10				
	CLS 350 CDI	165		04.09	10.10				
	CLS 350 CGI	215		04.09	10.10				
	CLS 350 CGI	215		04.06	10.10				
	CLS 500	225		08.04	10.10				
	CLS 500	285		04.06	10.10				
<b>MERCEDES BENZ CLS-Class (C218) Coupe (10-)</b>									
	CLS 250 CDI	150		11.10		G1020935		24310 19,0 + /WD/S	LUC
	CLS 350 BlueTec	185		01.13					
	CLS 350 BT 4-matic	185		01.13			- sport package/- sport package AMG <sup>1)</sup>		
	CLS 350 CDI	195		11.10					
	CLS 350 CDI 4-matic	195		09.11					
	CLS 350 CGI	225		11.10					
	CLS 250 CDI	150		11.10		G1020985		24862 16,7 +/WD	ATE
	CLS 350 BlueTec	185		01.13					
	CLS 350 BT 4-matic	185		01.13					
	CLS 350 CDI	195		11.10					
	CLS 350 CDI 4-matic	195		09.11					
	CLS 350 CGI	225		11.10					
	CLS 500	300		11.10					
	CLS 500 4-matic	300		11.10					
	CLS 250 CDI	150		11.10		G2110278		300 10,0 8,3 +S +C	
<b>MERCEDES BENZ CLS-Class (X218) Shooting Brake (12-)</b>									
	CLS 350	225		09.12		G1020935		24310 19,0 + /WD/S	LUC
	CLS 350 CDI	195		09.12			- sports package <sup>2)</sup>		
	CLS 350 CDI 4-matic	195		09.12					
	CLS 250 CDI	150		09.12		G1020985		24862 16,7 +/WD	ATE
	CLS 350	225		09.12					
	CLS 350 CDI	195		09.12					
	CLS 350 CDI 4-matic	195		09.12					
	CLS 500	300		09.12					
	CLS 500 4-matic	300		09.12					
	CLS 250 CDI	150		09.12		G2110278		300 10,0 8,3 +S +C	
<b>MERCEDES BENZ E-Class (W124) Saloon (93-95)</b>									
	E 200	100		06.93	06.95	G1020044		20941 19,3 /WD/S	LUC
	E 200 D	55		06.93	06.95				
	E 220	110		06.93	06.95				
	E 250 D	83		07.93	06.95				
	E 250 Turbo-D	93		06.93	06.95				
	E 280	145		06.93	06.95				
	E 300 4-matic	132		06.93	06.95				
	E 300 D	100		07.93	06.95				
	E 300 Turbo-D	108		06.93	06.95				
	E 300 Turbo-D 4-matic	108		06.93	06.95				
	E 200	100		06.93	06.95	G1020046		20687 15,5	ATE
	E 200 D	55		06.93	06.95				
	E 220	110		06.93	06.95				
	E 250 D	83		07.93	06.95				
	E 250 Turbo-D	93		06.93	06.95				
	E 280	145		06.93	06.95		- ASR		
	E 300 4-matic	132		06.93	06.95				
	E 300 D	100		07.93	06.95				
	E 300 Turbo-D	108		06.93	06.95				
	E 300 Turbo-D 4-matic	108		06.93	06.95				
	E 280	142		06.93	06.95	G1020339		21197 15,0 /WD	ATE
	E 320	162		06.93	06.95				
	E 36 AMG	200		07.94	06.95				
	E 420	205		06.93	06.95				
	E 500	235	B 927760	06.93					
	E 60 AMG	280	B 927760	05.94					
	E 500	235	B 927761		06.95	G1020400		21305 16,1 /WD	ATE
	E 60 AMG	280	B 927761		06.95				
	E 200	100		06.93	06.95	G2109120		258 9,0 7,3 +S +C	
	E 200 D	55		06.93	06.95				
	E 220	110		06.93	06.95				
	E 250 D	83		07.93	06.95				
	E 250 Turbo-D	93		06.93	06.95				
	E 280	145		06.93	06.95				
	E 300 4-matic	132		06.93	06.95				
	E 300 D	100		07.93	06.95				
	E 300 Turbo-D	108		06.93	06.95				
	E 300 Turbo-D 4-matic	108		06.93	06.95				
	E 320	162		06.93	06.95	G2109114		278 9,0 7,3 +S +C	
	E 36 AMG	200		07.94	06.95				

<sup>1)</sup> - pacchetto sportivo/- pacchetto sport.AMG / - version sport/- version sport AMG / - kit sportivo/- kit sportivo AMG / - Sportpaket / - Sportpaket AMG

<sup>2)</sup> - paccho sport / - version sport / - paquete deportivo / - Sportpaket



**MERCEDES BENZ E-Class (S214) Estate (93-96)**

	E 200	100		06.93	06.96	G1020044		20941 19,3 /WD/S	LUC
	E 220	110		06.93	06.96				
	E 250 D	83		06.93	06.96				
	E 250 Turbo D	93		06.93	06.96				
	E 280	145		06.93	06.96				
	E 300 4-matic	132		06.93	06.96				
	E 300 D	100		06.93	06.96				
	E 300 Turbo D	108		06.93	06.96				
	E 300 Turbo D 4-matic	108		06.93	06.96				
	E 200	100		06.93	06.96	G1020339		21197 15,0 /WD	ATE
	E 220	110		06.93	06.96				
	E 250 D	83		06.93	06.96				
	E 250 Turbo D	93		06.93	06.96				
	E 280	145		06.93	06.96				
	E 300 4-matic	132		06.93	06.96				
	E 300 D	100		06.93	06.96				
	E 300 TE-24	162		06.93	06.96				
	E 300 Turbo D	108		06.93	06.96				
	E 300 Turbo D 4-matic	108		06.93	06.96				
	E 320	162	F 323055	06.93	06.96				
	E 36 AMG	200	F 323055	05.94	06.96				
	E 320	162	F 323056		06.96	G1020400		21305 16,1 /WD	ATE
	E 36 AMG	200	F 323056		06.96				
	E 200	100		06.93	06.96	G2109114		278 9,0 7,3 +S +C	
	E 220	110		06.93	06.96				
	E 250 D	83		06.93	06.96				
	E 250 Turbo D	93		06.93	06.96				
	E 280	145		06.93	06.96				
	E 300 4-matic	132		06.93	06.96				
	E 300 D	100		06.93	06.96				
	E 300 Turbo D	108		06.93	06.96				
	E 300 Turbo D 4-matic	108		06.93	06.96				

**MERCEDES BENZ E-Class (C124) Coupe (93-97)**

	E 200	100		06.93	06.97	G1020044		20941 19,3 /WD/S	LUC					
	E 220	110		06.93	06.97									
	E 200	100		06.93	06.97	G1020046		20687 15,5	ATE					
	E 220	110		06.93	06.97									
	E 320	162		06.93	06.97									
	E 36 AMG	195		06.93	04.95									
	E 36 AMG	200		05.94	06.97	G1020339		21197 15,0 /WD	ATE					
		E 200	100		06.93					06.97	G2109120		258 9,0 7,3 +S +C	
		E 220	110		06.93					06.97				
	E 320	162		06.93	06.97	G2109114		278 9,0 7,3 +S +C						
	E 36 AMG	195		06.93	04.95									
	E 36 AMG	200		05.94	06.97									

**MERCEDES BENZ E-Class (A124) Convertible (93-98)**

	E 200	100		06.93	03.98	G1020044		20941 19,3 /WD/S	LUC
	E 220	110		06.93	03.98				
	E 200	100		06.93	03.98	G1020339		21197 15,0 /WD	ATE
	E 220	110		06.93	03.98				
	E 320	162		06.93	03.98				
	E 36 AMG	200		05.94	03.98				
	E 200	100		06.93	03.98	G2109114		278 9,0 7,3 +S +C	
	E 220	110		06.93	03.98				
	E 320	162		06.93	03.98				
	E 36 AMG	200		05.94	03.98				

**MERCEDES BENZ E-Class (W210) Saloon (95-02)**

	E 200			06.95	04.02	G1020398		21664 19,8 +/WD	ATE
	E 200 CDI			07.98	04.02				
	E 200 Compressor	120		08.00	04.02				
	E 200 D			10.96	04.02 + ⊕				
	E 220 CDI			07.98	04.02				
	E 220 D			06.95	06.98				
	E 230			06.95	08.97				
	E 240			09.97	04.02 - ESP				
	E 250 D			06.95	04.02				
	E 250 D			06.95	04.02 + ⊕				
	E 250 TD			09.97	04.02				
	E 290 TD			01.96	04.02				
	E 300 D			06.95	04.02				
		E 200 Compressor	137		09.97				
E 240				09.97	04.02 + ESP				
E 270 CDI				07.99	04.02				
E 280				01.96	04.02				
E 280 4-matic				10.96	04.02				
E 300 TD				10.96	04.02				
E 320				06.95	04.02				
E 320 4-matic				06.97	04.02				
E 320 CDI				07.99	04.02				
		E 420		A 962232 / X 027614		04.02	G1020683		21484 20,5 +/WD
	E 430		A 962232 / X 027614		04.02				







**MERCEDES BENZ E-Class (W210) Saloon (95-02)**

	E 430 4-matic E 50 AMG E 55 AMG			05.99 01.96 09.97	04.02 08.97 04.02	G1020683		21484 20,5 +/WD	ATE
	E 200 E 200 CDI E 200 Compressor E 200 D E 220 CDI E 220 D E 230 E 240 E 250 D E 250 D E 250 TD E 290 TD E 300 D	120		06.95 07.98 08.00 10.96 07.98 06.95 06.95 09.97 06.95 09.97 01.96 06.95	04.02 04.02 04.02 04.02 + P 04.02 06.98 08.97 04.02 04.02 + I 04.02 04.02 04.02	G2125110		288 25,0 22,4 V L +S +C	
	E 200 E 200 D E 220 D E 230 E 240 E 250 D E 250 D E 290 TD E 300 D		A379346 A379346 A379346 A379346 A379346 A379346 A379346 A379346 A379346	06.95 10.96 06.95 06.95 09.97 06.95 06.95 01.96 06.95		G1020339		21197 15,0 /WD	ATE
	E 200 E 200 CDI E 200 Compressor E 200 D E 220 CDI E 220 D E 230 E 240 E 250 D E 250 D E 250 TD E 290 TD E 300 D	120	A379347 A379347 A379347 A379347 A379347 A379347 A379347 A379347 A379347 A379347	07.98 08.00 07.98 06.98 08.97 04.02 04.02 09.97 04.02 04.02	04.02 04.02 04.02 + P 04.02 06.98 08.97 04.02 04.02 + I 04.02 04.02	G1020441		21919 15,3 /Acc	ATE
	E 280 E 280 4-matic E 300 TD E 320 E 320 4-matic E 420 E 430 E 55 AMG		A379346 A379346 A379346 A379346 A379346 A379346 A379346	01.96 10.96 10.96 06.95 06.97 01.96 09.97	04.02 04.02	G1020400		21305 16,1 /WD	ATE
	E 200 Compressor E 270 CDI E 280 E 280 4-matic E 300 TD E 320 E 320 4-matic E 320 CDI E 420 E 430	137	A379347 A379347 A379347 A379347 A379347 A379347 A379347 A379347	09.97 07.99 04.02 04.02 04.02 04.02 04.02 07.99 08.97 04.02	04.02 04.02 04.02 04.02 04.02 04.02 04.02 04.02	G1020442		21899 15,3 /WD/Acc	ATE
	E 430 4-matic			05.99	04.02	G1020400		21305 16,1 /WD	ATE
	E 200 E 200 CDI E 200 Compressor E 200 D E 220 CDI E 220 D E 230 E 240 E 250 D E 250 D E 250 TD E 290 TD E 300 D	120		06.95 07.98 08.00 10.96 07.98 06.95 06.95 09.97 06.95 09.97 01.96 06.95	04.02 04.02 04.02 04.02 + P 04.02 06.98 08.97 04.02 04.02 04.02 + I 04.02 04.02	G2109114		278 9,0 7,3 +S +C	
	E 200 Compressor E 270 CDI E 280 E 280 4-matic E 300 TD E 320 E 320 4-matic E 320 CDI E 420 E 430	137		09.97 07.99 01.96 10.96 10.96 06.95 06.97 07.99 01.96 09.97	04.02 04.02 04.02 04.02 04.02 04.02 04.02 04.02 08.97 04.02	G2110217		290 10,0 8,3 +S +C	



**MERCEDES BENZ E-Class (S210) Estate (96-03)**

	E 200		05.96	04.03	G1020398		21664 19,8 +/WD	ATE	
	E 200 Compressor	120	08.00	04.03					
	E 220 CDI		07.98	04.03					+ wheel base 2833 mm <sup>1)</sup>
	E 230		05.96	08.97					
	E 240		09.97	04.03					
	E 250 D		05.96	04.03					+ wheel base 2833 mm <sup>1)</sup>
	E 250 D		05.96	04.03					+  / + wheel base 2833mm <sup>2)</sup>
	E 250 TD		09.97	04.03					
	E 290 TD		05.96	04.03					+ wheel base 2833 mm <sup>1)</sup>
	E 200 Compressor	137	09.97	04.03					G1020401
E 220 CDI		07.98	04.03	+ wheel base 3570 mm <sup>3)</sup>					
E 250 D		05.96	04.03	+ wheel base 3570 mm <sup>3)</sup>					
E 270 CDI		07.99	04.03						
E 280		10.96	04.03	+ wheel base 3570 mm <sup>3)</sup>					
E 280 4-matic		10.96	04.03						
E 290 TD		05.96	04.03	+ wheel base 3570 mm <sup>3)</sup>					
E 300 TD		10.96	04.03						
E 320		10.96	04.03						
E 320 4-matic		06.97	04.03						
E 320 CDI		07.99	04.03						
E 420	A 962232 / X 027614		04.03	G1020683		21484 20,5 +/WD	ATE		
E 430	A 962232 / X 027614		04.03						
E 430 4-matic		05.99	04.03						
E 55 AMG		09.97	04.03						
	E 200		05.96	04.03	G2125110		288 25,0 22,4 V L +S +C		
	E 200 Compressor	120	08.00	04.03					
	E 220 CDI		07.98	04.03				+ wheel base 2833 mm <sup>1)</sup>	
	E 230		05.96	08.97					
	E 240		09.97	04.03					
	E 250 D		05.96	04.03				+ wheel base 2833 mm <sup>1)</sup>	
	E 250 D		05.96	04.03				+  / + wheel base 2833mm <sup>2)</sup>	
	E 250 TD		09.97	04.03					
	E 290 TD		05.96	04.03				+ wheel base 2833 mm <sup>1)</sup>	
		E 200		05.96				04.03	G1020400
E 200 Compressor			09.97	04.03					
E 220 CDI			07.98	04.03					
E 230			05.96	08.97					
E 240			09.97	04.03					
E 250 D			05.96	04.03	+ wheel base 3570 mm <sup>3)</sup>				
E 250 D			05.96	04.03	+ wheel base 2833 mm <sup>1)</sup>				
E 250 D			05.96	04.03	+  / + wheel base 2833mm <sup>2)</sup>				
E 250 TD			09.97	04.03					
E 270 CDI			07.99	04.03					
E 280			10.96	04.03	+ wheel base 3570 mm <sup>3)</sup>				
E 280 4-matic			10.96	04.03					
E 290 TD			05.96	04.03					
E 300 TD			10.96	04.03					
E 320			10.96	04.03					
E 320 4-matic			06.97	04.03					
E 320 CDI			07.99	04.03					
E 420			05.96	08.97					
E 430			09.97	04.03					
E 430 4-matic			05.99	04.03					
E 55 AMG		09.97	04.03						

**MERCEDES BENZ E-Class (W211) Saloon (02-09)**

	E 200 CDI	75	05.02	02.09	G1020632		23743 20,1 +/Wl/Acc/S	BOS					
	E 200 CDI	90	05.02	02.09					- sport package/- sport package AMG <sup>4)</sup>				
	E 200 CDI	100	04.06	02.09					- sport package/- sport package AMG <sup>4)</sup>				
	E 200 Kompressor	120	05.02	02.09					- sport package/- sport package AMG <sup>4)</sup>				
	E 200 Kompressor	135	04.06	02.09					- sport package/- sport package AMG <sup>4)</sup>				
	E 200 NGT	120	03.04	02.09					- sport package/- sport package AMG <sup>4)</sup>				
	E 220 CDI	100	03.02	02.09					- sport package/- sport package AMG <sup>4)</sup>				
	E 220 CDI	110	03.02	02.09					- sport package/- sport package AMG <sup>4)</sup>				
	E 220 CDI	120	03.03	02.09					- sport package/- sport package AMG <sup>4)</sup>				
	E 220 CDI	125	04.06	02.09					- sport package/- sport package AMG <sup>4)</sup>				
	E 230	150	04.06	02.09					- sport package/- sport package AMG <sup>4)</sup>				
	E 240	130	03.02	02.09									
	E 250 CDI	150	08.08	02.09									
	E 270 CDI	120	03.02	02.09									
	E 270 CDI	130	03.02	02.09									
	E 280	170	05.05	02.09					- sport package/- sport package AMG <sup>4)</sup>				
	E 280 CDI	130	05.04	02.09									
	E 280 CDI	140	03.05	02.09					- sport package/- sport package AMG <sup>4)</sup>				
	E 300 Bluetec	155	09.07	02.09					- sport package/- sport package AMG <sup>4)</sup>				
	E 320	165 A 400548		02.09									
	E 320 CDI	150 A 400548		02.09									
	E 320 CDI	165	03.05	02.09					- sport package/- sport package AMG <sup>4)</sup>				
	E 200 CDI	75	05.02	02.09					+ sports package/+ sports package AMG <sup>5)</sup>	G1020677		23745 17,6 +/WD(1,8/7,1)	BRE
	E 200 CDI	90	05.02	02.09					+ sports package/+ sports package AMG <sup>5)</sup>				
	E 200 CDI	100	04.06	02.09					+ sports package/+ sports package AMG <sup>5)</sup>				
	E 200 Kompressor	120	05.02	02.09					+ sports package/+ sports package AMG <sup>5)</sup>				
	E 200 Kompressor	135	04.06	02.09					+ sports package/+ sports package AMG <sup>5)</sup>				
	E 200 NGT	120	03.04	02.09					+ sports package/+ sports package AMG <sup>5)</sup>				
	E 220 CDI	100	03.02	02.09					+ sports package/+ sports package AMG <sup>5)</sup>				
	E 220 CDI	110	03.02	02.09					+ sports package/+ sports package AMG <sup>5)</sup>				
E 220 CDI	120	03.03	02.09	+ sports package/+ sports package AMG <sup>5)</sup>									

<sup>1)</sup> + passo 2833 mm / + empattement 2833 mm / + distancia entre ejes 2833 mm / + Radstand 2833mm

<sup>2)</sup> + / + passo 2833mm / + / + empattement 2833mm / + / + dist.entre ejes 2833mm / + / + Radstand 2833mm

<sup>3)</sup> + passo 3570 mm / + empattement 3570 mm / + distancia entre ejes 3570 mm / + Radstand 3570mm

<sup>4)</sup> - pacchetto sportivo/- pacchetto sport.AMG / - version sport/- version sport AMG / - kit sportivo/- kit sportivo AMG / - Sportpaket / - Sportpaket AMG

<sup>5)</sup> + pacchetto sportivo/+ pacchetto sport.AMG / + version sport/+ version sport AMG / + kit sportivo/+ kit sportivo AMG / + Sportpaket / + Sportpaket AMG





**MERCEDES BENZ E-Class (W211) Saloon (02-09)**

	E 220 CDI	125		04.06	02.09	+ sports package/+ sports package AMG <sup>1)</sup>	<b>G1020677</b>		23745 17,6 +/WD(1,8/7,1)	<b>BRE</b>				
	E 230	150		04.06	02.09	+ sports package/+ sports package AMG <sup>1)</sup>								
	E 280	170		05.05	02.09	+ sports package/+ sports package AMG <sup>1)</sup>								
	E 280 CDI	140		03.05	02.09	+ sports package/+ sports package AMG <sup>1)</sup>								
	E 300 Bluetec	155		09.07	02.09	+ sports package/+ sports package AMG <sup>1)</sup>								
	E 320	165	A 400547	03.02										
	E 320 CDI	150	A 400547	11.02										
	E 320 CDI	165		03.05	02.09	+ sports package/+ sports package AMG <sup>1)</sup>								
	E 350	200		12.04	02.09									
	E 350 CGI	215		09.07	02.09									
	E 400 CDI	191		03.03	02.09									
	E 500	225		03.02	02.09									
	E 240 4-matic	130		03.03	02.09									
	E 280 4-matic	170		05.05	02.09	- sport package/- sport package AMG <sup>2)</sup>								
E 280 CDI 4-matic	140		03.05	02.09	- sport package/- sport package AMG <sup>2)</sup>									
E 320 4-matic	165		03.03	02.09										
E 320 CDI 4-matic	165		03.05	02.09	- sport package/- sport package AMG <sup>2)</sup>									
E 350 4-matic	200		12.04	02.09	- sport package/- sport package AMG <sup>2)</sup>									
E 280 4-matic	170	A 870950	05.05		+ sports package/+ sports package AMG <sup>1)</sup>	<b>G1020683</b>		21484 20,5 +/WD	<b>ATE</b>					
E 280 CDI 4-matic	140	A 870950	03.05		+ sports package/+ sports package AMG <sup>1)</sup>									
E 320 CDI 4-matic	165	A 870950	03.05		+ sports package/+ sports package AMG <sup>1)</sup>									
E 350 4-matic	200	A 870950	12.04		+ sports package/+ sports package AMG <sup>1)</sup>									
E 500 4-matic	225	A 870950	10.03		+ sports package/+ sports package AMG <sup>1)</sup>									
E 280 4-matic	170	A 870951		02.09	+ sports package/+ sports package AMG <sup>1)</sup>	<b>G1020860</b>		23922 21,0 +/WD	<b>ATE</b>					
E 280 CDI 4-matic	140	A 870951		02.09	+ sports package/+ sports package AMG <sup>1)</sup>									
E 320 CDI 4-matic	165	A 870951		02.09	+ sports package/+ sports package AMG <sup>1)</sup>									
E 350 4-matic	200	A 870951		02.09	+ sports package/+ sports package AMG <sup>1)</sup>									
E 500 4-matic	225	A 870951		02.09		<b>G1020860</b>		23922 21,0 +/WD	<b>ATE</b>					
E 500 4-matic	285		04.06	02.09										
E 420 CDI	231		01.06	02.09		<b>G1020877</b>		23960 18,3 /WD	<b>BRE</b>					
E 500	285		04.06	02.09										
	E 200 CDI	75		05.02	02.09	- sport package/- sport package AMG <sup>2)</sup>	<b>G2128176</b>		295 28,0 25,4 V L +C					
	E 200 CDI	90		05.02	02.09	- sport package/- sport package AMG <sup>2)</sup>								
	E 200 CDI	100		04.06	02.09	- sport package/- sport package AMG <sup>2)</sup>								
	E 200 Kompressor	120		05.02	02.09	- sport package/- sport package AMG <sup>2)</sup>								
	E 200 Kompressor	135		04.06	02.09	- sport package/- sport package AMG <sup>2)</sup>								
	E 200 NGT	120		03.04	02.09	- sport package/- sport package AMG <sup>2)</sup>								
	E 220 CDI	100		03.02	02.09	- sport package/- sport package AMG <sup>2)</sup>								
	E 220 CDI	110		03.02	02.09	- sport package/- sport package AMG <sup>2)</sup>								
	E 220 CDI	120		03.03	02.09	- sport package/- sport package AMG <sup>2)</sup>								
	E 220 CDI	125		04.06	02.09	- sport package/- sport package AMG <sup>2)</sup>								
	E 230	150		04.06	02.09	- sport package/- sport package AMG <sup>2)</sup>								
	E 240	130		03.02	02.09	- sport package/- sport package AMG <sup>2)</sup>								
	E 200 CDI	75		05.02	02.09	+ sports package/+ sports package AMG <sup>1)</sup>					<b>G2132153</b>		330 32,0 30,0 V L +S +C	
	E 200 CDI	90		05.02	02.09	+ sports package/+ sports package AMG <sup>1)</sup>								
	E 200 CDI	100		04.06	02.09	+ sports package/+ sports package AMG <sup>1)</sup>								
	E 200 Kompressor	120		05.02	02.09	+ sports package/+ sports package AMG <sup>1)</sup>								
	E 200 Kompressor	135		04.06	02.09	+ sports package/+ sports package AMG <sup>1)</sup>								
	E 200 NGT	120		03.04	02.09	+ sports package/+ sports package AMG <sup>1)</sup>								
E 220 CDI	100		03.02	02.09	+ sports package/+ sports package AMG <sup>1)</sup>									
E 220 CDI	110		03.02	02.09	+ sports package/+ sports package AMG <sup>1)</sup>									
E 220 CDI	120		03.03	02.09	+ sports package/+ sports package AMG <sup>1)</sup>									
E 220 CDI	125		04.06	02.09	+ sports package/+ sports package AMG <sup>1)</sup>									
E 230	150		04.06	02.09	+ sports package/+ sports package AMG <sup>1)</sup>									
E 280	170		05.05	02.09	+ sports package/+ sports package AMG <sup>1)</sup>									
E 280 CDI	140		03.05	02.09	+ sports package/+ sports package AMG <sup>1)</sup>									
E 300 Bluetec	155		09.07	02.09	+ sports package/+ sports package AMG <sup>1)</sup>									
E 320 CDI	165		03.05	02.09	+ sports package/+ sports package AMG <sup>1)</sup>									
E 350	200		12.04	02.09	+ sports package/+ sports package AMG <sup>1)</sup>									
E 350 CGI	215		09.07	02.09	+ sports package/+ sports package AMG <sup>1)</sup>									
E 500	225		03.02	02.09	+ sports package/+ sports package AMG <sup>1)</sup>									
E 250 CDI	150		08.08	02.09		<b>G2128176</b>		295 28,0 25,4 V L +C						
E 270 CDI	120		03.02	02.09										
E 270 CDI	130		03.02	02.09										
E 280	170		05.05	02.09	- sport package/- sport package AMG <sup>2)</sup>									
E 280 CDI	130		05.04	02.09										
E 280 CDI	140		03.05	02.09	- sport package/- sport package AMG <sup>2)</sup>									
E 300 Bluetec	155		09.07	02.09	- sport package/- sport package AMG <sup>2)</sup>									
E 320	165	A 400548		02.09										
E 320 CDI	150	A 400548		02.09										
E 320 CDI	165		03.05	02.09	- sport package/- sport package AMG <sup>2)</sup>									
E 320	165	A 400547	03.02							<b>G2128142</b>		312 28,0 25,4 V L +C		
E 320 CDI	150	A 400547	11.02											
E 350	200		12.04	02.09	- sport package/- sport package AMG <sup>2)</sup>	<b>G2132144</b>		330 32,0 29,4 V L +S +C						
E 350 CGI	215		09.07	02.09	- sport package/- sport package AMG <sup>2)</sup>									
E 400 CDI	191		03.03	02.09										
E 500	225		03.02	02.09	- sport package/- sport package AMG <sup>2)</sup>									
	E 200 CDI	75		05.02	02.09		<b>G1020652</b>		23334 16,7 +/WD	<b>ATE</b>				
	E 200 CDI	90		05.02	02.09									
	E 200 CDI	100		04.06	02.09									
	E 200 Kompressor	120		05.02	02.09									
	E 200 Kompressor	135		04.06	02.09									
	E 200 NGT	120		03.04	02.09									
	E 220 CDI	100		03.02	02.09									
	E 220 CDI	110		03.02	02.09									

<sup>1)</sup> + pacchetto sportivo/+ pacchetto sport.AMG / + version sport/+ version sport AMG / + kit sportivo/+ kit sportivo AMG / + Sportpaket / + Sportpaket AMG

<sup>2)</sup> - pacchetto sportivo/- pacchetto sport.AMG / - version sport/- version sport AMG / - kit sportivo/- kit sportivo AMG / - Sportpaket / - Sportpaket AMG



**MERCEDES BENZ E-Class (W211) Saloon (02-09)**

	E 220 CDI	120		03.03	02.09		G1020652		23334 16,7 +WD	ATE
	E 220 CDI	125		04.06	02.09					
	E 230	150		04.06	02.09					
	E 240	130		03.02	02.09					
	E 240 4-matic	130		03.03	02.09					
	E 250 CDI	150		08.08	02.09					
	E 270 CDI	120		03.02	02.09					
	E 270 CDI	130		03.02	02.09					
	E 280	170		05.05	02.09					
	E 280 4-matic	170		05.05	02.09					
	E 280 CDI	130		05.04	02.09					
	E 280 CDI	140		03.05	02.09					
	E 280 CDI 4-matic	140		03.05	02.09					
	E 300 Bluetec	155		09.07	02.09					
	E 320	165		03.02	02.09					
	E 320 4-matic	165		03.03	02.09					
	E 320 CDI	150		11.02	02.09					
	E 320 CDI	165		03.05	02.09					
	E 320 CDI 4-matic	165		03.05	02.09					
	E 350	200		12.04	02.09					
	E 350 4-matic	200		12.04	02.09					
	E 350 CGI	215		09.07	02.09					
	E 400 CDI	191		03.03	02.09					
	E 420 CDI	231		01.06	02.09					
E 500	225		03.02	02.09						
E 500	285		04.06	02.09						
E 500 4-matic	225		10.03	02.09						
E 500 4-matic	285		04.06	02.09						
	E 200 CDI	75		05.02	02.09	-Taxi/-sports pack./-sports pack.AMG 1)	G2110278		300 10,0 8,3 +S +C	
	E 200 CDI	90		05.02	02.09	-Taxi/-sports pack./-sports pack.AMG 1)				
	E 200 CDI	100		04.06	02.09	-Taxi/-sports pack./-sports pack.AMG 1)				
	E 200 Kompressor	120		05.02	02.09	-Taxi/-sports pack./-sports pack.AMG 1)				
	E 200 Kompressor	135		04.06	02.09	-Taxi/-sports pack./-sports pack.AMG 1)				
	E 200 NGT	120		03.04	02.09	-Taxi/-sports pack./-sports pack.AMG 1)				
	E 220 CDI	100		03.02	02.09	-Taxi/-sports pack./-sports pack.AMG 1)				
	E 220 CDI	110		03.02	02.09	-Taxi/-sports pack./-sports pack.AMG 1)				
	E 220 CDI	120		03.03	02.09	-Taxi/-sports pack./-sports pack.AMG 1)				
	E 220 CDI	125		04.06	02.09	-Taxi/-sports pack./-sports pack.AMG 1)				
	E 230	150		04.06	02.09	- sport package/- sport package AMG 2)				
	E 240	130		03.02	02.09	- Taxi				
	E 240 4-matic	130		03.03	02.09					
	E 250 CDI	150		08.08	02.09	- Taxi				
	E 270 CDI	120		03.02	02.09	- Taxi				
	E 270 CDI	130		03.02	02.09	- Taxi				
	E 280 4-matic	170		05.05	02.09	- sport package/- sport package AMG 2)				
	E 280 CDI	140		03.05	02.09	- sport package/- sport package AMG 2)				
	E 280 CDI 4-matic	140		03.05	02.09	- sport package/- sport package AMG 2)				
	E 320	165	A 400547	03.02	02.09	- Taxi				
	E 320 4-matic	165 X 122526			02.09					
	E 320 CDI	150	A 400547	11.02		- Taxi				

**MERCEDES BENZ E-Class (S211) Estate (03-09)**

	E 200 CDI	100		04.06	10.09	- sport package/- sport package AMG 2)	G1020632		23743 20,1 +/MI/Acc/S	BOS	
	E 200 Compressor	120		03.03	10.09	- sport package/- sport package AMG 2)					
	E 200 Kompressor	135		04.06	10.09	- sport package/- sport package AMG 2)					
	E 220 CDI	125		03.03	10.09	- sport package/- sport package AMG 2)					
	E 220 CDI	130		04.06	10.09	- sport package/- sport package AMG 2)					
	E 240	130		03.03	10.09						
	E 270 CDI	120		03.03	10.09						
	E 270 CDI	130		03.03	10.09						
	E 280 CDI	140		03.05	10.09	- sport package/- sport package AMG 2)					
	E 200 CDI	100		04.06	10.09	+ sports package/+ sports package AMG 3)	G1020677				23745 17,6 +/WD(1,8/7,1)
E 200 Compressor	120		03.03	10.09	+ sports package/+ sports package AMG 3)						
E 200 Kompressor	135		04.06	10.09	+ sports package/+ sports package AMG 3)						
E 220 CDI	125		03.03	10.09	+ sports package/+ sports package AMG 3)						
E 220 CDI	150		04.06	10.09	+ sports package/+ sports package AMG 3)						
E 230	150		05.07	10.09							
E 280 CDI	140		03.05	10.09	+ sports package/+ sports package AMG 3)						
E 350 CGI	215		05.06	10.09							
E 280	170		05.05	10.09		G1020677		23745 17,6 +/WD(1,8/7,1)	BRE		
E 280 CDI	130		05.04	10.09							
E 320	165		03.03	10.09							
E 320 CDI	150		03.03	10.09							
E 320 CDI	165		03.05	10.09							
E 350	200		12.04	10.09							
E 500	225		10.03	10.09		G1020677		23745 17,6 +/WD(1,8/7,1)	BRE		
E 500 4-matic	225		10.03	10.09							
E 240 4-matic	130		07.03	10.09		G1020776		21670 19,3 +/WD	ATE		
E 280 4-matic	170		05.05	10.09	- sport package/- sport package AMG 2)						
E 280 CDI 4-matic	140		05.05	10.09	- sport package/- sport package AMG 2)						
E 320 4-matic	165		07.03	10.09							
E 320 CDI 4-matic	165		05.05	10.09	- sport package/- sport package AMG 2)						
E 350 4-matic	200		12.04	10.09	- sport package/- sport package AMG 2)						
E 280 4-matic	170	A 870950	05.05		+ sports package/+ sports package AMG 3)	G1020683		21484 20,5 +/WD	ATE		
E 280 CDI 4-matic	140	A 870950	05.05		+ sports package/+ sports package AMG 3)						
E 320 CDI 4-matic	165	A 870950	05.05		+ sports package/+ sports package AMG 3)						
E 350 4-matic	200	A 870950	12.04		+ sports package/+ sports package AMG 3)						

1) -Taxi/-pacch.sport./-pacch.sport AMG / -Taxi/-vers.sport/-vers.sport AMG / -Taxi/-kit deport./-kit deport. AMG / - Taxi / - Sportpaket / - Sportpaket AMG  
 2) - pacchetto sportivo/- pacchetto sport.AMG / - version sport/- version sport AMG / - kit sportivo/- kit sportivo AMG / - Sportpaket / - Sportpaket AMG  
 3) + pacchetto sportivo/+ pacchetto sport.AMG / + version sport/+ version sport AMG / + kit sportivo/+ kit sportivo AMG / + Sportpaket / + Sportpaket AMG





**MERCEDES BENZ E-Class (S211) Estate (03-09)**

	E 500 4-matic	225	A 870950	10.03		G1020683		21484 20,5 +/WD	ATE
	E 280 4-matic	170 A 870951				G1020860		23922 21,0 +/WD	ATE
	E 280 CDI 4-matic	140 A 870951			10.09				
	E 320 CDI 4-matic	165 A 870951			10.09				
	E 350 4-matic	200 A 870951			10.09				
	E 500 4-matic	225 A 870951			10.09	G1020860		23922 21,0 +/WD	ATE
	E 500 4-matic	285		04.06	10.09				
	E 500	285		04.06	10.09	G1020877		23960 18,3 /WD	BRE
	E 200 CDI	100		04.06	10.09	G2128176		295 28,0 25,4 V L +C	
	E 200 Compressor	120		03.03	10.09				
	E 200 Kompressor	135		04.06	10.09				
	E 220 CDI	125		03.03	10.09				
	E 220 CDI	125		04.06	10.09				
	E 240	130		03.03	10.09				
	E 270 CDI	120		03.03	10.09				
	E 270 CDI	130		03.03	10.09				
	E 280 CDI	140		03.05	10.09				
	E 230	150		05.07	10.09	G2128142		312 28,0 25,4 V L +C	
	E 280	170		05.05	10.09				
	E 280 CDI	130		05.04	10.09				
	E 320	165		03.03	10.09				
	E 320 CDI	150		03.03	10.09				
	E 320 CDI	165		03.05	10.09				
	E 200 CDI	100		04.06	10.09	G2132153		330 32,0 30,0 V L +S +C	
	E 200 Compressor	120		03.03	10.09				
	E 200 Kompressor	135		04.06	10.09				
	E 220 CDI	125		03.03	10.09				
	E 220 CDI	125		04.06	10.09				
	E 230	150		05.07	10.09				
	E 280	170		05.05	10.09				
	E 280 CDI	140		03.05	10.09				
	E 350	200		12.04	10.09				
	E 350 CGI	215		05.06	10.09				
	E 500	225		10.03	10.09				
	E 350	200		12.04	10.09	G2132144		330 32,0 29,4 V L +S +C	
	E 350 CGI	215		05.06	10.09				
	E 500	225		10.03	10.09				
	E 200 CDI	100		04.06	10.09	G1020652		23334 16,7 +/WD	ATE
	E 200 Compressor	120		03.03	10.09				
	E 200 Kompressor	135		04.06	10.09				
	E 220 CDI	125		03.03	10.09				
	E 220 CDI	125		04.06	10.09				
	E 230	150		05.07	10.09				
	E 240	130		03.03	10.09				
	E 240 4-matic	130		07.03	10.09				
	E 270 CDI	120		03.03	10.09				
	E 270 CDI	130		03.03	10.09				
	E 280	170		05.05	10.09				
	E 280 4-matic	170		05.05	10.09				
	E 280 CDI	130		05.04	10.09				
	E 280 CDI	140		03.05	10.09				
	E 280 CDI 4-matic	140		05.05	10.09				
	E 320	165		03.03	10.09				
	E 320 4-matic	165		07.03	10.09				
	E 320 CDI	150		03.03	10.09				
	E 320 CDI 4-matic	165		05.05	10.09				
	E 350	200		12.04	10.09				
	E 350 4-matic	200		12.04	10.09				
	E 350 CGI	215		05.06	10.09				
	E 500	225		10.03	10.09				
	E 500	285		04.06	10.09				
	E 500 4-matic	225		10.03	10.09				
	E 500 4-matic	285		04.06	10.09				
	E 200 CDI	100		04.06	10.09	G2110278		300 10,0 8,3 +S +C	
	E 200 Compressor	120		03.03	10.09				
	E 200 Kompressor	135		04.06	10.09				
	E 220 CDI	125		03.03	10.09				
	E 220 CDI	125		04.06	10.09				
	E 240	130		03.03	10.09				
	E 240 4-matic	130		07.03	10.09				

**MERCEDES BENZ E-Class (W212) Saloon (09-)**

	E 200 CDI	100		03.09	- sport package/- sport package AMG <sup>2)</sup>	G1020933		24306 20,3 /WD/Acc/S	LUC
	E 200 CGI	135		08.09	- sport package/- sport package AMG <sup>2)</sup>				
	E 200 NGT	120		03.09	- sport package/- sport package AMG <sup>2)</sup>				
	E 220 CDI	125		03.09	- sport package/- sport package AMG <sup>2)</sup>				
	E 250	150		03.09	- sport package/- sport package AMG <sup>2)</sup>				
	E 250 CDI	150	A 001284	03.09	- sport package/- sport package AMG <sup>2)</sup>				
	E 200 CDI	100		03.09	+ sports package/+ sports package AMG <sup>1)</sup>	G1020935		24310 19,0 + /WD/S	LUC
	E 200 CGI	135		08.09	+ sports package/+ sports package AMG <sup>1)</sup>				
	E 200 NGT	120		03.09	+ sports package/+ sports package AMG <sup>1)</sup>				
	E 220 CDI	125		03.09	+ sports package/+ sports package AMG <sup>1)</sup>				
	E 250	150		03.09	+ sports package/+ sports package AMG <sup>1)</sup>				
	E 250 CDI	150		03.09	+ sports package/+ sports package AMG <sup>1)</sup>				
	E 250 CDI	150 A 001285		03.09	+ sports package/+ sports package AMG <sup>1)</sup>				
	E 250 CDI 4-matic	150		03.09	- sport package/- sport package AMG <sup>2)</sup>				

<sup>1)</sup> + pacchetto sportivo/+ pacchetto sport.AMG / + version sport/+ version sport AMG / + kit sportivo/+ kit sportivo AMG / + Sportpaket / + Sportpaket AMG  
<sup>2)</sup> - pacchetto sportivo/- pacchetto sport.AMG / - version sport/- version sport AMG / - kit sportivo/- kit sportivo AMG / - Sportpaket / - Sportpaket AMG  
<sup>3)</sup> - Taxi/-pacch.sport./-pacch.sport AMG / - Taxi/-vers.sport/-vers.sport AMG / - Taxi/-kit deport./-kit deport. AMG / - Taxi / - Sportpaket / - Sportpaket AMG



**MERCEDES BENZ E-Class (W212) Saloon (09-)**

	E 250 CGI	150		01.09		G1020935		24310 19,0 + /WD/S	LUC
	E 300	170		03.09					
	E 300 BE 4-matic	185		07.11					
	E 300 BlueEfficiency	185		07.11					
	E 300 BlueTec Hybrid	150		06.12					
	E 300 CDI			04.11					
	E 350	200		03.09					
	E 350	225		09.11					
	E 350 4-matic	200		03.09					
	E 350 4-matic	225		09.11					
	E 350 Bluetec	155		03.09					
	E 350 BlueTec	185		01.13			- sport package/- sport package AMG <sup>1)</sup>		
	E 350 BlueTec 4-matic	185		01.13			- sport package/- sport package AMG <sup>1)</sup>		
	E 350 CDI	170		03.09					
	E 350 CDI	195		03.11					
E 350 CDI 4-matic	170		03.09						
E 350 CDI 4-matic	195		03.11						
E 350 CGI	215		03.09						
E 400 Hybrid			06.12			- sport package/- sport package AMG <sup>1)</sup>	G1020935	24310 19,0 + /WD/S	LUC
	E 200 CDI	100		03.09		G1020985		24862 16,7 +/WD	ATE
	E 200 CGI	135		08.09					
	E 200 NGT	120		03.09					
	E 220 CDI			03.09					
	E 250			03.09					
	E 250 CDI	150		03.09					
	E 250 CDI 4-matic	150		03.09					
	E 250 CGI	150		01.09					
	E 300	170		03.09					
	E 300 BE 4-matic	185		07.11					
	E 300 BlueEfficiency	185		07.11					
	E 300 BlueTec Hybrid	150		06.12					
	E 300 CDI			04.11					
	E 350	200		03.09					
	E 350	225		09.11					
	E 350 4-matic	200		03.09					
	E 350 4-matic	225		09.11					
	E 350 Bluetec	155		03.09					
	E 350 BlueTec	185		01.13					
	E 350 BlueTec 4-matic	185		01.13					
	E 350 CDI	170		03.09					
	E 350 CDI	195		03.11					
	E 350 CDI 4-matic	170		03.09					
	E 350 CDI 4-matic	195		03.11					
	E 350 CGI	215		03.09					
E 400	245		01.13						
E 400 4-matic	245		01.13						
E 400 Hybrid			06.12						
E 500	285		03.09						
E 500	300		09.11						
E 500 4-matic	285		03.09						
E 500 4-matic	300		09.11						
	E 200 CDI	100		03.09		G2110278		300 10,0 8,3 +S +C	
	E 200 CGI	135		08.09					
	E 200 NGT	120		03.09					
	E 220 CDI			03.09					
	E 250			03.09					
	E 250 CDI	150 A 007599		03.09					
	E 250 CDI 4-matic	150		03.09					
	E 250 CGI	150		01.09					

**MERCEDES BENZ E-Class (S212) Estate (09-)**

	E 200	135		03.13		G1020933		24306 20,3 /WD/Acc/S	LUC
	E 200 CDI	100		11.09					
	E 200 CGI	135		11.09					
	E 220 CDI	125		11.09					
	E 200	135		03.13		G1020935		24310 19,0 + /WD/S	LUC
	E 200 CDI	100		11.09					
	E 200 CGI	135		11.09					
	E 220 CDI	125		11.09					
	E 250	155		03.13					
	E 250 CDI	150		11.09					
	E 250 CDI 4-matic	150		07.10					
	E 250 CGI	150		11.09					
	E 300	185		07.11					
	E 300 4-matic	185		07.11					
	E 300 BlueTec Hybrid	150		06.12					
	E 300 CDI	150		03.11					
	E 350	200		11.09					
	E 350	225		09.11					
	E 350 4-matic	200		11.09					
	E 350 4-matic	225		09.11					
	E 350 BlueTec	155		11.09					
	E 350 BlueTec	185		01.13					
	E 350 BlueTec 4-matic	185		01.13					
	E 350 CDI	170		11.09					
E 350 CDI	195		07.11						
E 350 CDI 4-matic	170		11.09						

<sup>1)</sup> - pacchetto sportivo/- pacchetto sport.AMG / - version sport/- version sport AMG / - kit sportivo/- kit sportivo AMG / - Sportpaket / - Sportpaket AMG

<sup>2)</sup> + pacchetto sportivo/+ pacchetto sport.AMG / + version sport/+ version sport AMG / + kit sportivo/+ kit sportivo AMG / + Sportpaket / + Sportpaket AMG





**MERCEDES BENZ E-Class (S212) Estate (09-)**

	E 350 CDI 4-matic E 350 CGI	195 215	07.11 11.09		G1020935		24310 19,0 + /WD/S	LUC
	E 200 E 200 CDI E 200 CGI E 220 CDI E 250 E 250 CDI E 250 CDI 4-matic E 250 CGI E 300 E 300 4-matic E 300 BlueTec Hybrid E 300 CDI E 350 E 350 E 350 4-matic E 350 4-matic E 350 BlueTec E 350 BlueTec E 350 BlueTec 4-matic E 350 CDI E 350 CDI E 350 CDI 4-matic E 350 CDI 4-matic E 350 CGI E 400 E 400 4-matic E 500 E 500 E 500 4-matic	135 100 135 125 155 150 150 150 185 185 150 150 200 225 200 225 155 185 185 170 195 170 195 215 245 245 285 300 300	03.13 11.09 11.09 11.09 03.13 11.09 07.10 11.09 07.11 07.11 06.12 03.11 11.09 09.11 11.09 09.11 11.09 01.13 01.13 11.09 07.11 11.09 11.09 01.13 01.13 11.09 09.11 09.11		G1020985		24862 16,7 +/WD	ATE
	E 200 E 200 CDI E 200 CGI E 220 CDI E 250 E 250 CDI E 250 CDI 4-matic E 250 CGI	135 100 135 125 155 150 150 150	03.13 11.09 11.09 11.09 03.13 11.09 07.10 11.09		G2110278		300 10,0 8,3 +S +C	

**MERCEDES BENZ E-Class (C207) Coupe (09-)**

	E 200 E 200 CGI E 220 CDI E 250 CGI	135 135 125 150	03.13 09.09 05.09 05.09	- sport package/- sport package AMG <sup>1)</sup> - sport package/- sport package AMG <sup>1)</sup> - sport package/- sport package AMG <sup>1)</sup> - sport package/- sport package AMG <sup>1)</sup>	G1020933		24306 20,3 /WD/Acc/S	LUC
	E 200 E 200 CGI E 220 CDI E 250 E 250 CDI E 250 CGI E 300 CGI E 350 E 350 BlueTec E 350 CDI E 350 CDI	135 135 125 155 150 150 185 225 185 170 195	03.13 09.09 05.09 03.13 05.09 05.09 04.11 09.09 01.13 05.09 04.11	+ sports package/+ sports package AMG <sup>2)</sup> + sports package/+ sports package AMG <sup>2)</sup> + sports package/+ sports package AMG <sup>2)</sup>  + sports package/+ sports package AMG <sup>2)</sup>	G1020935		24310 19,0 + /WD/S	LUC
	E 400 E 500 E 500	245 285 300	03.13 05.09 06.13		G1020935		24310 19,0 + /WD/S	LUC
	E 200 E 200 CGI E 220 CDI E 250 E 250 CDI E 250 CGI E 350 BlueTec E 400	135 135 125 155 150 150 185 245	03.13 09.09 05.09 03.13 05.09 05.09 01.13 03.13		G1020963		24253 17,8 +/WD	ATE
	E 300 CGI E 350 E 350 CDI E 350 CDI E 350 CGI E 500 E 500 E 550 CGI	185 225 170 195 215 285 300 300	04.11 09.09 05.09 04.11 05.09 05.09 06.13 09.11		G1020963	+ aluminium calipers <sup>3)</sup>	24253 17,8 +/WD	ATE

**MERCEDES BENZ E-Class (A207) Convertible (10-)**

	E 200 E 200 CGI E 220 CDI E 250 CGI	135 135 125 150	03.13 03.10 03.10 03.10	- sport package/- sport package AMG <sup>1)</sup> - sport package/- sport package AMG <sup>1)</sup> - sport package/- sport package AMG <sup>1)</sup> - sport package/- sport package AMG <sup>1)</sup>	G1020933		24306 20,3 /WD/Acc/S	LUC
	E 200 E 200 CGI E 220 CDI E 250	135 135 125 155	03.13 03.10 03.10 03.13	+ sports package/+ sports package AMG <sup>2)</sup> + sports package/+ sports package AMG <sup>2)</sup> + sports package/+ sports package AMG <sup>2)</sup>	G1020935		24310 19,0 + /WD/S	LUC

<sup>1)</sup> - pacchetto sportivo/- pacchetto sport.AMG / - version sport/- version sport AMG / - kit sportivo/- kit sportivo AMG / - Sportpaket / - Sportpaket AMG  
<sup>2)</sup> + pacchetto sportivo/+ pacchetto sport.AMG / + version sport/+ version sport AMG / + kit sportivo/+ kit sportivo AMG / + Sportpaket / + Sportpaket AMG  
<sup>3)</sup> + pinze in alluminio / + étriers en aluminium / + pinzas de aluminio / + ALU-Sättel





MERCEDES BENZ E-Class (A207) Convertible (10-)																
	E 250 CDI	150		03.10	+ sports package/+ sports package AMG <sup>1)</sup>	G1020935			24310 19,0 + /WD/S	LUC						
	E 250 CGI	150		03.10												
	E 300 CGI	185		03.10												
	E 350	225		04.11												
	E 350 BlueTec	185		01.13												
	E 350 CDI	170		03.10												
	E 350 CDI	195		04.11												
	E 350 CGI	215		03.10												
E 400	245		03.13		G1020935			24310 19,0 + /WD/S	LUC							
E 500	285		03.10													
	E 200	135		03.13		G1020963			24253 17,8 +/WD	ATE						
	E 200 CGI	135		03.10												
	E 220 CDI	125		03.10												
	E 250	155		03.13												
	E 250 CDI	150		03.10												
	E 250 CGI	150		03.10												
	E 300 CGI	185		03.10												
	E 350 BlueTec	185		01.13												
	E 400	245		03.13												
	E 350	225		04.11								G1020963		+ aluminium calipers <sup>2)</sup>	24253 17,8 +/WD	ATE
	E 350 CDI	170		03.10												
E 350 CDI	195		04.11													
E 350 CGI	215		03.10													
E 500	285		03.10													
E 500	300		06.13													
E 550 CGI	300		09.11													
MERCEDES BENZ G-Class (W463) (90-)																
	G 320 CDI			09.06		G1020583			23021 18,9 /WD	BOS						
	G 350 CDI BlueTec			06.10												
	G 500	285		05.08												
G 65 AMG	450		06.12			G1020862			23923 17,6 +/WD	ATE						
MERCEDES BENZ G-Class (W463) Convertible (90-)																
	G 320 CDI			09.06		G1020583			23021 18,9 /WD	BOS						
	G 350 CDI BlueTec			06.10												
MERCEDES BENZ GL-Class (X164) (06-12)																
	GL 320 CDI 4-matic			03.06	06.12	G1020860			+ 19" wheel <sup>3)</sup>	23922 21,0 +/WD	ATE					
	GL 350 BT 4-matic			05.09	06.12											
	GL 350 CDI 4-matic			05.09	06.12											
	GL 420 CDI 4-matic			03.06	06.12											
	GL 450 4-matic			03.06	06.12											
	GL 450 CDI 4-matic			05.09	06.12											
GL 500 4-matic			03.06	06.12												
	GL 320 CDI 4-matic			03.06	06.12	G1020862				23923 17,6 +/WD	ATE					
	GL 350 BT 4-matic			05.09	06.12											
	GL 350 CDI 4-matic			05.09	06.12											
	GL 420 CDI 4-matic			03.06	06.12											
	GL 450 4-matic			03.06	06.12											
	GL 450 CDI 4-matic			05.09	06.12											
GL 500 4-matic			03.06	06.12												
MERCEDES BENZ GLK-Class (X204) (08-)																
	GLK 200 CDI	105		07.10		G2132144				330 32,0 29,4 V L +S +C						
	GLK 220 CDI			04.09												
	GLK 220 CDI 4-matic			04.09												
	GLK 250 BT 4-matic			03.12												
	GLK 250 BT 4-matic			03.12												
	GLK 250 CDI 4-matic	150		09.08												
	GLK 280 4-matic	170		09.08												
	GLK 300 4-matic	170		04.09												
	GLK 320 CDI 4-matic	165		09.08												
	GLK 350	200		09.08												
	GLK 350 4-matic	200		09.08												
	GLK 350 4-matic	225		09.08												
	GLK 350 CDI 4-matic	165		04.09												
	GLK 350 CDI 4-matic	170		02.10												
GLK 350 CDI 4-matic	195		07.12													
MERCEDES BENZ M-Class (W163) (98-05)																
	ML 270 CDI	X754620		06.05		G1020574			23271 17,6 +/WD(1,8)	BRE						
	ML 270 CDI	A289560		06.05												
	ML 320	X754620		08.02												
	ML 320	A289560		08.02												
	ML 350			09.02	06.05											
	ML 400 CDI			07.01	06.05											
	ML 430	X707756		06.05												
	ML 430	A145273		06.05												
	ML 500			07.01	06.05											
	ML 55 AMG			09.99	06.05											











<sup>1)</sup> + pacchetto sportivo/+ pacchetto sport.AMG / + version sport/+ version sport AMG / + kit deportivo/+ kit deportivo AMG / + Sportpaket / + Sportpaket AMG

<sup>2)</sup> + pinze in alluminio / + étriers en aluminium / + pinzas de aluminio / + ALU-Sättel

<sup>3)</sup> + ruota 19" / + roue 19" / + rueda 19" / + 19" Rad





								
<b>MERCEDES BENZ M-Class (W163) (98-05)</b>								
	ML 270 CDI	X754620		06.05		G2132114		345 31,9 30,0 V L +C
	ML 270 CDI	A289560		06.05				
	ML 320	X754620		08.02				
	ML 320	A289560		08.02				
	ML 350			09.02	06.05			
	ML 400 CDI			07.01	06.05			
	ML 430	X707756			06.05			
	ML 430	A145273			06.05			
	ML 500			07.01	06.05			
	ML 55 AMG			09.99	06.05			
	ML 270 CDI	X754620		06.05		G1020575		23157 15,8 /WD/Acc BRE
	ML 270 CDI	A289560		06.05				
	ML 320	X754620		08.02				
	ML 320	A289560		08.02				
	ML 350			09.02	06.05			
	ML 400 CDI			07.01	06.05			
	ML 430	X707756			06.05			
	ML 430	A145273			06.05			
	ML 500			07.01	06.05			
	ML 55 AMG			09.99	06.05			
<b>MERCEDES BENZ M-Class (W164) (05-11)</b>								
	ML 280 CDI			07.05	05.11	G1020860		23922 21,0 +/WD ATE
	ML 300			05.09	05.11			
	ML 300 CDI 4-matic			07.09	05.11			
	ML 320 CDI			07.05	05.11			
	ML 350			07.05	05.11			
	ML 350 BT 4-matic			05.09	05.11			
	ML 350 CDI 4-matic			07.09	05.11			
	ML 420 CDI 4-matic			04.06	05.11	G1020860		23922 21,0 +/WD ATE
	ML 450 CDI 4-matic			09.09	05.11			
	ML 450 Hybrid 4-matic			08.09	05.11			
	ML 500			07.05	05.11			
	ML 280 CDI			07.05	05.11	G1020862		23923 17,6 +/WD ATE
	ML 300			05.09	05.11			
	ML 300 CDI 4-matic			07.09	05.11			
	ML 320 CDI			07.05	05.11			
	ML 350			07.05	05.11			
	ML 350 BT 4-matic			05.09	05.11			
	ML 350 CDI 4-matic			07.09	05.11			
	ML 420 CDI 4-matic			04.06	05.11			
	ML 450 CDI 4-matic			09.09	05.11			
	ML 450 Hybrid 4-matic			08.09	05.11			
	ML 500			07.05	05.11			
	<b>MERCEDES BENZ R-Class (W251,V251) (06-12)</b>							
	R 280			01.07	10.12	G1020860		23922 21,0 +/WD ATE
	R 280 CDI 4-matic			11.05	10.12			
	R 300			07.09	10.12			
	R 300 CDI			07.09	10.12			
	R 300 CDI 4-matic			07.09	10.12			
	R 320 CDI 4-matic			11.05	10.12			
	R 350			11.05	10.12			
	R 350 BT 4-matic			05.09	10.12			
	R 350 CDI 4-matic			05.09	10.12			
		R 280 CDI			05.06	10.12	G1020860	
R 350 4-matic				01.06	10.12			
R 500 4-matic				11.05	10.12			
	R 280			01.07	10.12	G1020862	+ 18" wheel <sup>1)</sup>	23923 17,6 +/WD ATE
	R 280 CDI 4-matic			11.05	10.12			
	R 300			07.09	10.12			
	R 300 CDI			07.09	10.12			
	R 300 CDI 4-matic			07.09	10.12			
	R 320 CDI 4-matic			11.05	10.12			
	R 350			11.05	10.12			
	R 350 BT 4-matic			05.09	10.12			
	R 350 CDI 4-matic			05.09	10.12			
	R 500 4-matic			11.05	10.12			
	R 280 CDI			05.06	10.12	G1020862		23923 17,6 +/WD ATE
	R 350 4-matic			01.06	10.12			
<b>MERCEDES BENZ S-Class (W140) (91-93)</b>								
	300 SE 2.8 / S 280			08.92	06.93	G1020400		21305 16,1 /WD ATE
	300 SE 3.2			04.91	06.93			
	300 SEL 3.2			04.91	06.93			
	350 SD Turbo			03.93	06.93			
	400 SE			04.91	06.93			
	400 SEL			04.91	06.93			
	500 SE			04.91	06.93			
	500 SEC			06.92	06.93			
	500 SEL			04.91	06.93			
	600 SE V12			04.91	06.93			
	600 SEC V12			06.92	06.93			
	600 SEL V12			04.91	06.93			

<sup>1)</sup> + ruota 18" / + roue 18" / + rueda 18" / + 18" Rad



**MERCEDES BENZ S-Class (W140) (93-98)**

	S 280 / 300 SE 2.8			07.93	10.98	G1020400	21305 16,1 /WD	ATE
	S 300 TD			04.96	10.98			
	S 320			07.93	10.98			
	S 350 TD			07.93	06.96			
	S 420			07.93	10.98			
	S 420 C			04.94	05.96			
	S 500			07.93	10.98			
	S 500 C			07.93	05.96			
	S 600			07.93	10.98			
	S 600 C			07.93	05.96			

**MERCEDES BENZ S-Class (W220) (98-06)**

	S 280			11.98	12.01	G1020574	23271 17,6 +/WD(1,8)	BRE			
	S 320			11.98	12.01						
	S 320 CDI	145		08.99	12.01						
	S 400 CDI			08.00	12.01						
	S 430			11.98	12.01						
	S 500			11.98	12.01				- armoured vehicles <sup>1)</sup>	23271 17,6 +/WD(1,8)	BRE
	S 55 AMG			04.99	12.01						
	S 280			01.02	03.06				G1020677 G1020574	23745 17,6 +/WD(1,8/7,1) 23271 17,6 +/WD(1,8)	BRE BRE
	S 320			01.02	03.06						
	S 320 CDI	145		01.02	03.06				G1020677 G1020574	23745 17,6 +/WD(1,8/7,1) 23271 17,6 +/WD(1,8)	BRE BRE
S 320 CDI	150		09.02	03.06							
S 350			09.02	03.06	G1020677 G1020574	23745 17,6 +/WD(1,8/7,1) 23271 17,6 +/WD(1,8)	BRE BRE				
S 370			08.04	03.06							
S 400 CDI			01.02	03.06	G1020677 G1020574	23745 17,6 +/WD(1,8/7,1) 23271 17,6 +/WD(1,8)	BRE BRE				
S 430			01.02	03.06							
S 500			01.02	03.06	- armoured vehicles <sup>1)</sup>	23745 17,6 +/WD(1,8/7,1) 23271 17,6 +/WD(1,8)	BRE BRE				
S 55 AMG			01.02	03.06							
S 600			08.99	03.06	- armoured vehicles <sup>1)</sup>						
S 350 4-matic			06.03	03.06	G1020776	21670 19,3 +/WD	ATE				
S 430 4-matic			09.02	03.06	G1020683	21484 20,5 +/WD	ATE				
S 500 4-matic			09.02	03.06							
	S 280			11.98	03.06	G2128125	312 28,0 26,0 V L +C				
	S 320			11.98	03.06						
	S 350			09.02	03.06						
	S 370			08.04	03.06						
	S 320 CDI	145		08.99	03.06				G2132115	330 32,0 30,0 V L +C	
	S 320 CDI	150		09.02	03.06						
	S 400 CDI			08.00	03.06						
	S 430			11.98	03.06						
	S 500			11.98	03.06						
	S 320 CDI	150		09.02	03.06				G1020652	23334 16,7 +/WD	ATE
S 350			09.02	03.06							
S 350 4-matic			06.03	03.06							
S 400 CDI			10.02	03.06							
S 430			10.02	03.06							
S 430 4-matic			09.02	03.06							
S 500			10.02	03.06	- armoured vehicles <sup>1)</sup>						
S 500 4-matic			09.02	03.06							
S 600			08.99	03.06	- armoured vehicles <sup>1)</sup>						
S 500			11.98	03.06	+ armoured vehicles <sup>2)</sup>	21305 16,1 /WD	ATE				
S 600			08.99	03.06	+ armoured vehicles <sup>2)</sup>						

**MERCEDES BENZ S-Class (W221) (06-13)**

	S 250 CDI	150		01.11	05.13	G1020877	23960 18,3 /WD	BRE	
	S 280 / S 300	170		04.06	05.13				
	S 320 CDI	155		12.05	05.13				
	S 320 CDI / S 350 CDI	173		12.05	05.13				
	S 320 CDI 4-matic	155		12.05	05.13				
	S 320 CDI 4-matic	173		05.06	05.13				
	S 350	200		12.05	05.13				
	S 350 4-matic	200		02.07	05.13				
	S 350 BlueTec	190		04.11	05.13				
	S 350 BlueTec 4-matic	190		04.11	05.13				
	S 350 CGI	225		04.11	05.13				
	S 350 CGI 4-matic	225		04.11	05.13				
	S 400 Hybrid	205		06.09	05.13				
	S 420 CDI / S 450 CDI	235		04.06	05.13				
	S 450	250		04.06	05.13				
	S 450 4-matic	250		04.06	05.13				
	S 500	285		12.05	05.13				
	S 500 4-matic	285		04.06	05.13				
	S 280 / S 300	170		04.06	05.13	G1020652	23334 16,7 +/WD	ATE	
	S 320 CDI	155	A 289058	12.05					
	S 320 CDI / S 350 CDI	173	A 289058	12.05					
	S 320 CDI 4-matic	155	A 289058	12.05					
	S 320 CDI 4-matic	173	A 289058	05.06					
	S 350	200	A 289058	12.05					
	S 350 4-matic	200	A 289058	02.07					
	S 350 BlueTec	190		04.11	05.13				- sport package AMG <sup>3)</sup>
	S 350 BlueTec 4-matic	190		04.11	05.13				- sport package AMG <sup>3)</sup>
	S 350 CGI	225		04.11	05.13				- sport package AMG <sup>3)</sup>
	S 350 CGI 4-matic	225		04.11	05.13				- sport package AMG <sup>3)</sup>
	S 400 Hybrid	205	A 289058	06.09					

<sup>1)</sup> - veicoli blindati / - véhicules blindés / - vehiculo blindado / - gepanzerte Fahrzeuge  
<sup>2)</sup> - veicoli blindati / + véhicule blindé / + vehiculo blindado / + gepanzerte Fahrzeuge  
<sup>3)</sup> - pacchetto sportivo AMG / - version sport AMG / - kit deportivo AMG / - Sportpaket AMG





MERCEDES BENZ SLK-Class (R170) (96-04)											
	SLK 320	160		04.00	03.04		G2109114				278 9,0 7,3 +S +C
MERCEDES BENZ SLK-Class (R171) (04-11)											
	SLK 200 Compressor	120		03.04	01.11	- sport package 1)	G1020924				23144 19,8 +/WD/Acc/S LUC
	SLK 200 Kompressor	135		01.08	01.11	- sport package 1)	G1020925				23144 19,8 +/WD/Acc/S LUC
	SLK 280	170		04.05	01.11	- sport package 1)					
	SLK 300	170		03.09	01.11	- sport package 1)					
	SLK 350	200	F 117328	03.04			G1020677				23745 17,6 +/WD(1,8/7,1) BRE
	SLK 200 Compressor	120		03.04	01.11	+ sports package 2)	G1020659				23945 16,5 /WD BRE
	SLK 200 Kompressor	135		01.08	01.11	+ sports package 2)					
	SLK 280	170		04.05	01.11	+ sports package 2)					
	SLK 300	170		03.09	01.11	+ sports package 2)					
	SLK 350	200	F 117329		01.11						
	SLK 350	224		01.08	01.11						
	SLK 55 AMG		F 197202		01.11		G1020677				23745 17,6 +/WD(1,8/7,1) BRE
	SLK 200 Compressor	120		03.04	01.11	- sport package 1)	G2125110				288 25,0 22,4 V L +S +C
	SLK 200 Kompressor	135		01.08	01.11	+ sports package 2)	G2128177				330 28,0 26,0 V L +C
	SLK 280	170		04.05	01.11	+ sports package 2)					
	SLK 300	170		03.09	01.11	+ sports package 2)					
	SLK 350	200		03.04	01.11						
	SLK 350	224		01.08	01.11						
	SLK 200 Compressor	120		03.04	01.11	- sport package 1)	G1020441				21919 15,3 /Acc ATE
	SLK 200 Kompressor	135		01.08	01.11	- sport package 1)					
	SLK 280	170		04.05	01.11	- sport package 1)					
	SLK 300	170		03.09	01.11	- sport package 1)					
	SLK 200 Compressor	120		03.04	01.11	+ sports package 2)	G1020442				21899 15,3 /WD/Acc ATE
	SLK 200 Kompressor	135		01.08	01.11	+ sports package 2)					
	SLK 280	170		04.05	01.11	+ sports package 2)					
	SLK 300	170		03.09	01.11	+ sports package 2)					
	SLK 350	200		03.04	01.11	+ sports package 2)					
	SLK 200 Compressor	120		03.04	01.11	- sport package 1)	G2109114				278 9,0 7,3 +S +C
	SLK 200 Kompressor	135		01.08	01.11	- sport package 1)					
	SLK 280	170		04.05	01.11	- sport package 1)					
	SLK 300	170		03.09	01.11	- sport package 1)					
	SLK 200 Compressor	120		03.04	01.11	+ sports package 2)	G2110217				290 10,0 8,3 +S +C
	SLK 200 Kompressor	135		01.08	01.11	+ sports package 2)					
	SLK 280	170		04.05	01.11	+ sports package 2)					
	SLK 300	170		03.09	01.11	+ sports package 2)					
	SLK 350	200		03.04	01.11						
MERCEDES BENZ SLK-Class (R172) (11-)											
	SLK 200	135		02.11			G1020933				24306 20,3 /WD/Acc/S LUC
	SLK 250	150		02.11							
	SLK 250 CDI	150		01.12			G1020935				24310 19,0 +/WD/S LUC
	SLK 350	225		02.11							
MERCEDES BENZ Vaneo (BM414) (02-05)											
	1.4	60		06.02	12.05		G1020615				23070 19,4 /WD/S LUC
	1.6	60		02.02	12.05						
	1.6	75		02.02	12.05						
	1.7 CDI	55		02.02	12.05						
	1.7 CDI	67		02.02	12.05						
	1.9	92		02.02	12.05						
	1.4	60		06.02	12.05		G1020544				23138 14,6 /S LUC
	1.6	60		02.02	12.05						
	1.6	75		02.02	12.05						
	1.7 CDI	55		02.02	12.05						
	1.7 CDI	67		02.02	12.05						
	1.9	92		02.02	12.05						
MERCEDES BENZ V-Class (BM638) (96-03)											
	V 200			09.96	08.03		G1020742				21576 20,7 +/WD ATE
	V 200 CDI			03.99	08.03						
	V 220 CDI			03.99	08.03						
	V 230			09.96	08.03						
	V 230 TD			09.96	08.03						
	V 280			09.97	08.03						
	V 200			09.96	08.03		G1020582				23022 20,9 /WD BOS
	V 200 CDI			03.99	08.03						
	V 220 CDI			03.99	08.03						
	V 230			09.96	08.03						
	V 230 TD			09.96	08.03						
	V 280			09.97	08.03						
	V 200			09.96	08.03		G1020395				21904 16,9 +/Wl ATE
	V 200 CDI			03.99	08.03		G1020584				23020 17,9 BOS
	V 220 CDI			03.99	08.03						
	V 230			09.96	08.03						
	V 230 TD			09.96	08.03						
	V 280			09.97	08.03						

1) - pacchetto sportivo / - version sport / - kit sportivo / - Sportpaket  
2) + pacchetto sportivo / + version sport / + kit sportivo / + Sportpaket



**MERCEDES BENZ VIANO (BM639) (03-)**

	2.0 CDI		342257	08.03	G1020751	24007 20,8 /W/S	BOS
	2.0 CDI 4-matic		342257	07.10			
	2.2 CDI		342257	08.03			
	2.2 CDI 4-matic		342257	07.10			
	3.0	140	342257	08.03			
	3.0 CDI		342257	03.06			
	3.2	160	342257	08.03			
	3.5	190	342257	09.07			
3.7	170	342257	06.04				
	2.0 CDI		342258		G1020769	29192 20,7 /WD/Acc	BRE
	2.0 CDI 4-matic		342258				
	2.2 CDI		342258				
	2.2 CDI 4-matic		342258				
	3.0	140	342258				
	3.0 CDI		342258				
	3.2	160	342258				
	3.5	190	342258				
3.7	170	342258					
	2.0 CDI			08.03	G1020752	24008 18,3 /W/S	BOS
	2.0 CDI 4-matic			07.10			
	2.2 CDI			08.03			
	2.2 CDI 4-matic			07.10			
	3.0	140		08.03			
	3.0 CDI			03.06			
	3.2	160		08.03			
	3.5	190		09.07			
3.7	170		06.04				

**MERCEDES BENZ VITO (BM638) (96-03)**

	108 CDI			03.99	08.03	G1020742	21576 20,7 +/WD	ATE
	108 D			03.96	08.03			
	110 CDI			03.99	08.03			
	110 D			03.96	08.03			
	112 CDI			03.99	08.03			
	113			03.96	08.03			
	114			12.96	08.03			
	108 CDI			03.99	08.03	G1020582	23022 20,9 /WD	BOS
	108 D			03.96	08.03			
	110 CDI			03.99	08.03			
	110 D			03.96	08.03			
	112 CDI			03.99	08.03			
	113			03.96	08.03			
	114			12.96	08.03			
	108 CDI			03.99	08.03	G1020395 G1020584	21904 16,9 +/WI 23020 17,9	ATE BOS
	108 D			03.96	08.03			
	110 CDI			03.99	08.03			
	110 D			03.96	08.03			
	112 CDI			03.99	08.03			
	113			03.96	08.03			
	114			12.96	08.03			

**MERCEDES BENZ VITO (BM639) (03-)**

	109 CDI		342257	08.03	G1020751	24007 20,8 /W/S	BOS				
	109 CDI 4-matic	70	407625	09.07							
	110 CDI	70	342257	09.10							
	111 CDI		342257	08.03							
	111 CDI 4-matic	80	407625	09.07							
	113 CDI	100	342257	09.10							
	113 CDI 4-matic	100	407625	09.10							
	115 CDI	110	342257	08.03							
	115 CDI 4-matic	110	407625	09.07							
	116 CDI	120	342257	09.10							
	116 CDI 4-matic	120	407625	09.10							
	119	140	342257	08.03							
	120 CDI	150	342257	09.07							
	122	160	342257	08.03							
	122 CDI	165	342257	09.10							
	123	170	342257	06.04							
	123	190	342257	09.07							
	126	190	342257	09.07							
	E-Cell	60		03.12							
		109 CDI		342258					G1020769	29192 20,7 /WD/Acc	BRE
		109 CDI 4-matic	70	407626							
		110 CDI	70	342258							
		111 CDI		342258							
111 CDI 4-matic		80	407626								
113 CDI		100	342258								
113 CDI 4-matic		100	407626								
115 CDI		110	342258								
115 CDI 4-matic		110	407626								
116 CDI		120	342258								
116 CDI 4-matic		120	407626								
119		140	342258								
120 CDI		150	342258								
122		160	342258								
122 CDI		165	342258								
123		170	342258								



### MERCEDES BENZ VITO (BM639) (03-)

	123 126 E-Cell	190 342258 190 342258 60							G1020769			29192 20,7 /WD/Acc	BRE
	109 CDI 109 CDI 4-matic 110 CDI 111 CDI 111 CDI 4-matic 113 CDI 113 CDI 4-matic 115 CDI 115 CDI 4-matic 116 CDI 116 CDI 4-matic 119 120 CDI 122 122 CDI 123 123 126 E-Cell	70 70 80 100 100 110 110 120 120 140 150 160 165 170 190 190 60							G1020752			24008 18,3 /W/S	BOS

### MERCEDES BENZ Transporter (BM 901/902) SPRINTER (95-06)

	208 CDI 208 D 210 D 211 CDI 212 D 213 CDI 214 214 216 CDI	92 105			04.00 05.06 02.95 05.06 01.97 05.06 04.00 05.06 02.95 05.06 04.00 05.06 04.00 05.06 02.95 05.06 04.00 05.06				G1020742			21576 20,7 +/WD	ATE
	208 CDI 208 D 210 D 211 CDI 212 D 213 CDI 214 214 216 CDI	92 105			04.00 05.06 02.95 05.06 01.97 05.06 04.00 05.06 02.95 05.06 04.00 05.06 04.00 05.06 02.95 05.06 04.00 05.06				G1020891			29153 20,0 /WD/Acc/S	PER
	208 CDI 208 D 210 D 211 CDI 212 D 213 CDI 214 214 216 CDI	92 105			04.00 05.06 02.95 05.06 01.97 05.06 04.00 05.06 02.95 05.06 04.00 05.06 04.00 05.06 02.95 05.06 04.00 05.06				G2122161			276 22,0 19,0 V L +S +C	
	208 CDI (BM 901) 208 D (BM 901) 210 D (BM 901) 211 CDI (BM 901) 212 D (BM 901) 213 CDI (BM 901) 214 (BM 901) 214 (BM 901) 216 CDI (BM 901)	92 105			04.00 05.06 02.95 05.06 01.97 05.06 04.00 05.06 02.95 05.06 04.00 05.06 04.00 05.06 02.95 05.06 04.00 05.06				G1020396	for design sample 901 <sup>1)</sup>		21621 17,3 +/WD	ATE
	208 CDI (BM 902) 208 D (BM 902) 210 D (BM 902) 211 CDI (BM 902) 212 D (BM 902) 213 CDI (BM 902) 214 (BM 902) 214 (BM 902) 216 CDI (BM 902)	92 105			04.00 05.06 02.95 05.06 01.97 05.06 04.00 05.06 02.95 05.06 04.00 05.06 04.00 05.06 02.95 05.06 04.00 05.06				G1020397 G1020583	for design sample 902 <sup>2)</sup> for design sample 902 <sup>2)</sup>		21592 18,8 +/WD 23021 18,9 /WD	ATE BOS

### MERCEDES BENZ Transporter (BM 903/904) SPRINTER (95-06)

	308 CDI 308 D 310 D 311 CDI 312 D 313 CDI 314 314 316 CDI 408 CDI 408 D 410 D 411 CDI 412 D 413 CDI 414	92 105			04.00 05.06 02.95 05.06 02.95 05.06 04.00 05.06 02.95 05.06 04.00 05.06 04.00 05.06 02.95 05.06 04.00 05.06 06.95 05.06 09.96 05.06 04.00 05.06 06.95 05.06 04.00 05.06 04.00 05.06				G1020742			21576 20,7 +/WD	ATE
--	--	-----------	--	--	---	--	--	--	----------	--	--	-----------------	-----

<sup>1)</sup> per modello tipo 901 / pour modèle type 901 / para modelo construcc. 901 / für Baumuster 901

<sup>2)</sup> per modello tipo 902 / pour modèle type 902 / para modelo construcc. 902 / für Baumuster 902





**MERCEDES BENZ Transporter (BM 903/904) SPRINTER (95-06)**

	414	105	06.95	05.06	G1020742	21576 20,7 +/WD	ATE	
	416 CDI		04.00	05.06				
		308 CDI		04.00	05.06	G1020891	29153 20,0 /WD/Acc/S	PER
		308 D		02.95	05.06			
		310 D		02.95	05.06			
		311 CDI		04.00	05.06			
		312 D		02.95	05.06			
		313 CDI		04.00	05.06			
		314	92	04.00	05.06			
		314	105	02.95	05.06			
		316 CDI		04.00	05.06			
		408 CDI		04.00	05.06			
		408 D		06.95	05.06			
		410 D		09.96	05.06			
		411 CDI		04.00	05.06			
		412 D		06.95	05.06			
413 CDI			04.00	05.06				
414	92	04.00	05.06					
414	105	06.95	05.06					
416 CDI		04.00	05.06					
	308 CDI		04.00	05.06	G2122161	276 22,0 19,0 V L +S +C		
	308 D		02.95	05.06				
	310 D		02.95	05.06				
	311 CDI		04.00	05.06				
	312 D		02.95	05.06				
	313 CDI		04.00	05.06				
	314	92	04.00	05.06				
	314	105	02.95	05.06				
	316 CDI		04.00	05.06				
	408 CDI		04.00	05.06				
	408 D		06.95	05.06				
	410 D		09.96	05.06				
	411 CDI		04.00	05.06				
	412 D		06.95	05.06				
	413 CDI		04.00	05.06				
	414	92	04.00	05.06				
414	105	06.95	05.06					
416 CDI		04.00	05.06					
	308 CDI		04.00	05.06	G1020397	21592 18,8 +/WD	ATE	
	308 D		02.95	05.06				
		310 D		02.95	05.06	G1020583	23021 18,9 /WD	BOS
		311 CDI		04.00	05.06			
		312 D		02.95	05.06			
		313 CDI		04.00	05.06			
		314	92	04.00	05.06			
		314	105	02.95	05.06			
		316 CDI		04.00	05.06			
		408 CDI		04.00	05.06			
408 D		06.95	05.06					
410 D		09.96	05.06					
411 CDI		04.00	05.06					
412 D		06.95	05.06					
413 CDI		04.00	05.06					
414	92	04.00	05.06					
414	105	06.95	05.06					
416 CDI		04.00	05.06					
	408 CDI		04.00	05.06	G1020891	29153 20,0 /WD/Acc/S	PER	
	408 D		06.95	05.06				
	410 D		09.96	05.06				
	411 CDI		04.00	05.06				
	412 D		06.95	05.06				
	413 CDI		04.00	05.06				
	414	92	04.00	05.06				
	414	105	06.95	05.06				
	416 CDI		04.00	05.06				

**MERCEDES BENZ Transporter (BM 905) SPRINTER (01-06)**

	616 CDI		04.01	05.06	G1020891	29153 20,0 /WD/Acc/S	PER
	616 CDI		04.01	05.06	G2122161	276 22,0 19,0 V L +S +C	

**MERCEDES BENZ Transporter (BM 906) SPRINTER (06-)**

	209 CDI		04.06		G1020769	29192 20,7 /WD/Acc	BRE
	210 CDI		03.09				
	211 CDI		04.06				
	213 CDI		04.06				
	215 CDI		04.06				
	216		09.08				
	216 CDI		03.09				
	218 CDI		04.06				
	224		04.06				
	309 CDI		04.06				
	310 CDI		03.09				
	311 CDI		04.06				
	311 CDI 4x4		02.08				
	313 CDI		04.06				
	313 CDI 4x4		06.06				
	315 CDI		04.06				
	315 CDI 4x4		02.08				
	316		09.08				
	316 CDI		03.09				
	316 CDI 4x4		03.09				
316 LGT	115	09.08					



**MERCEDES BENZ Transporter (BM 906) SPRINTER (06-)**

	316 NGT		09.08	G1020769	29192 20,7 /WD/Acc	BRE			
	318 CDI		04.06						
	318 CDI 4x4		02.08						
	319 CDI		03.09						
	319 CDI 4x4		03.09						
	324		04.06						
	411 CDI	80	06.09				G1020770	29200 21,0 /WD/Acc	BRE
	413 CDI		04.06						
	415 CDI		04.06						
	416 CDI	120	03.09						
	418 CDI		04.06						
	419 CDI	140	03.09						
	424		04.06						
	509 CDI		04.06						
	510 CDI	70	03.09						
511 CDI		04.06							
511 CDI 4x4	80	06.06							
513 CDI		03.09							
513 CDI 4x4	95	06.06							
515 CDI		04.06							
515 CDI 4x4	110	06.06							
516	115	09.08							
516 CDI		03.09							
516 CDI 4x4	120	06.06							
516 NGT	115	09.08							
518 CDI		04.06							
518 CDI 4x4	135	06.06							
519 CDI		03.09							
519 CDI 4x4	140	03.09							
524		04.06							
	209 CDI		04.06	G2128203	300 28,0 25,0 V L +S +C				
	210 CDI		03.09						
	211 CDI		04.06						
	213 CDI		04.06						
	215 CDI		04.06						
	216		09.08						
	216 CDI		03.09						
	218 CDI		04.06						
	224		04.06						
	309 CDI		04.06						
	310 CDI		03.09						
	311 CDI		04.06						
	311 CDI 4x4		02.08						
	313 CDI		04.06						
	313 CDI 4x4		06.06						
	315 CDI		04.06						
	315 CDI 4x4		02.08						
	316		09.08						
	316 CDI		03.09						
	316 CDI 4x4		03.09						
	316 LGT	115	09.08						
	316 NGT		09.08						
	318 CDI		04.06						
	318 CDI 4x4		02.08						
	319 CDI		03.09						
	319 CDI 4x4		03.09						
	324		04.06						
	411 CDI	80	06.09						
	413 CDI		04.06						
	415 CDI		04.06						
	416 CDI	120	03.09						
	418 CDI		04.06						
	419 CDI	140	03.09						
	424		04.06						
	509 CDI		04.06						
	510 CDI	70	03.09						
	511 CDI		04.06						
	511 CDI 4x4	80	06.06						
	513 CDI		03.09						
	513 CDI 4x4	95	06.06						
	515 CDI		04.06						
	515 CDI 4x4	110	06.06						
	516	115	09.08						
	516 CDI		03.09						
	516 CDI 4x4	120	06.06						
516 NGT	115	09.08							
518 CDI		04.06							
518 CDI 4x4	135	06.06							
519 CDI		03.09							
519 CDI 4x4	140	03.09							
524		04.06							
	209 CDI		04.06	G1020922	29190 20,2 +/W/Acc/S	BOS			
	210 CDI		03.09						
	211 CDI		04.06						
	213 CDI		04.06						
	215 CDI		04.06						
	216		09.08						







**MERCEDES BENZ Transporter (BM 906) SPRINTER (06-)**

	216 CDI			03.09		G1020922		29190 20,2 +/W/Acc/S	BOS	
	218 CDI			04.06						
	224			04.06						
	309 CDI			04.06						
	310 CDI			03.09						
	311 CDI			04.06						
	311 CDI 4x4			02.08						
	313 CDI			04.06						
	313 CDI 4x4			06.06						
	315 CDI			04.06						
	315 CDI 4x4			02.08						
	316			09.08						
	316 CDI			03.09						
	316 CDI 4x4			03.09						
	316 LGT	115		09.08						
	316 NGT			09.08						
	318 CDI			04.06						
	318 CDI 4x4			02.08						
	319 CDI			03.09						
	319 CDI 4x4			03.09						
	324			04.06						
	411 CDI	80		06.09			G1020940		29217 20,5 /S	BOS
	413 CDI			04.06						
	415 CDI			04.06						
	416 CDI	120		03.09						
	418 CDI			04.06						
419 CDI	140		03.09							
424			04.06							
509 CDI			04.06							
510 CDI	70		03.09							
511 CDI			04.06							
511 CDI 4x4	80		06.06							
513 CDI			03.09							
513 CDI 4x4	95		06.06							
515 CDI			04.06							
515 CDI 4x4	110		06.06							
516	115		09.08							
516 CDI			03.09							
516 CDI 4x4	120		06.06							
516 NGT	115		09.08							
518 CDI			04.06							
518 CDI 4x4	135		06.06							
519 CDI			03.09							
519 CDI 4x4	140		03.09							
524			04.06							

**MG ZR (01-05)**

	105	76		06.01	12.05		G2121105		262 21,0 19,0 V +S +C
	120	86		06.01	12.05				
	Turbodiesel	74		06.01	12.05				
	105	76		06.01	12.05		G2110212		239 10,0 8,0 +S +C
	120	86		06.01	12.05				
	Turbodiesel	74		06.01	12.05				

**MG ZT Saloon (01-05)**

	2.5 V6 (190)	140		06.01	12.05	+ brake disc 325 X 25 <sup>1)</sup>	G1020591		23183 20,3 +/WD	ATE
	4.6 V8 (260X)	191		10.03	12.05	+ brake disc 325 X 25 <sup>1)</sup>				
	1.8 16V (160)	118		06.01	12.05		G1020316		20180 17,1 +/WD	ATE
	1.8 T 16V (160)	118		01.03	12.05					
	2.0 CDTi	85		06.02	09.03					
	2.0 CDTi	96		11.02	12.05					
	2.5 V6 (180)	130		01.03	12.05					
	2.5 V6 (190)	140		06.01	12.05					





















**MG ZT-T Estate (01-05)**

















	2.5 V6 (190)	140		10.01	12.05	+ brake disc 325 X 25 <sup>1)</sup>	G1020591		23183 20,3 +/WD	ATE
	4.6 V8 (260X)	191		10.03	12.05	+ brake disc 325 X 25 <sup>1)</sup>				
	1.8 16V (160)	118		10.01	12.05		G1020316		20180 17,1 +/WD	ATE
	1.8 T 16V (160)	118		01.03	12.05					
	2.0 CDTi	85		06.02	09.03					
	2.0 CDTi	96		11.02	12.05					
	2.5 V6 (180)	130		01.03	12.05					
	2.5 V6 (190)	140		10.01	12.05					







**MINI R50/R53 (00-06)**



















	Cooper	85		06.00	11.06		G1020646		23762 20,4 +/W/I	ATE
	Cooper S			07.02	11.06					
	One	66		06.00	11.06					
	One 1.4			06.00	11.06					
	One D			03.03	11.06					
Cooper S JCW	155		11.03	02.06		G1020856		23984 17,8 +/WD/Acc/S	LUC	
Cooper S JCW	155		03.06	11.06		G1020856		23984 17,8 +/WD/Acc/S	LUC	





















<sup>1)</sup> + dischi freno 325 X 25 / + disque de frein 325 X 25 / + disco de freno 325 X 25 / + Bremsscheibe 325 X 25



















								
<b>MINI R50/R53 (00-06)</b>								
	Cooper Cooper S One One 1.4 One D	85 66		06.00 07.02 06.00 06.00 03.03	11.06 11.06 11.06 11.06 11.06	G2122204		276 22,0 20,4 V L +C
	Cooper Cooper S Cooper S JCW One One 1.4 One D	85 155 66		06.00 07.02 11.03 06.00 06.00 03.03	11.06 11.06 11.06 11.06 11.06 11.06	G1020648		23716 15,8 +/WD ATE
	Cooper Cooper S Cooper S JCW One One 1.4 One D	85 155 66		06.00 07.02 11.03 06.00 06.00 03.03	11.06 11.06 11.06 11.06 11.06 11.06	G2110271		259 10,0 8,4 +C
<b>MINI R52 Convertible (04-08)</b>								
	Cooper Cooper S One Cooper S JCW Cooper S JCW	85 125 66 155 155		04.04 04.04 04.04 11.03 06.06	08.08 08.08 08.08 05.06 08.08	G1020646		23762 20,4 +/WI ATE
						G1020856		23984 17,8 +/WD/Acc/S LUC
						G1020856		23984 17,8 +/WD/Acc/S LUC
	Cooper Cooper S One	85 125 66		04.04 04.04 04.04	08.08 08.08 08.08	G2122204		276 22,0 20,4 V L +C
	Cooper Cooper S Cooper S JCW One	85 125 155 66		04.04 04.04 11.03 04.04	08.08 08.08 08.08 08.08	G1020648		23716 15,8 +/WD ATE
	Cooper Cooper S Cooper S JCW One	85 125 155 66		04.04 04.04 11.03 04.04	08.08 08.08 08.08 08.08	G2110271		259 10,0 8,4 +C
<b>MINI R55 Clubman (07-)</b>								
	Cooper Cooper D Cooper SD One One D Cooper S	105 66		09.07 09.07 02.11 03.10 03.10 09.07		G1020794		23915 17,6 +/WD/Acc/S LUC
						G1020856		23984 17,8 +/WD/Acc/S LUC
	Cooper Cooper D Cooper S John Cooper Works One One D Cooper Cooper D Cooper S Cooper SD John Cooper Works One One D	155 66		09.07 09.07 09.07 03.08 03.10 03.10 09.10 09.10 09.10 02.11 09.10 09.10 09.10	08.10 08.10 08.10 08.10 08.10 08.10	G1020796		24289 16,9 +/WD/Acc/S LUC
						G1020796		24289 16,9 +/WD/Acc/S LUC
	Cooper Cooper D Cooper S Cooper SD One One D	105 66		09.07 09.07 09.07 02.11 03.10 03.10		G2110271		259 10,0 8,4 +C
<b>MINI R55 Clubvan (12-)</b>								
	Cooper Cooper D One	90 82 72		12.12 12.12 12.12		G1020794		23915 17,6 +/WD/Acc/S LUC
	Cooper Cooper D One	90 82 72		12.12 12.12 12.12		G1020796		24289 16,9 +/WD/Acc/S LUC
	Cooper Cooper D One	90 82 72		12.12 12.12 12.12		G2110271		259 10,0 8,4 +C
<b>MINI R56 (06-)</b>								
	Cooper Cooper Cooper Cooper D Cooper SD One One One One D Cooper S	85 88 90 55 70 72 66		03.10 11.06 03.10 04.07 02.11 03.09 04.07 03.10 03.10 03.10		G1020794		23915 17,6 +/WD/Acc/S LUC
						G1020856		23984 17,8 +/WD/Acc/S LUC

								
<b>MINI R56 (06-)</b>								
	Cooper S Cooper S	128 147		11.06 01.12			G1020856	23984 17,8 +/WD/Acc/S LUC
	Cooper Cooper Cooper Cooper D Cooper S Cooper S John Cooper Works John Cooper Works One One One One D	85 88 90   128 155 160 55 70 72 66		03.10 08.10 11.06 08.10 03.10 08.10 04.07 08.10 03.10 08.10 11.06 08.10 03.08 08.10 07.07 08.10 03.09 08.10 04.07 08.10 03.10 08.10 03.10 08.10			G1020796	24289 16,9 +/WD/Acc/S LUC
	Cooper Cooper Cooper Cooper D Cooper S Cooper S Cooper SD John Cooper Works John Cooper Works John Cooper Works GP One One One One D	85 88 90   128 147  155 160 160 55 70 72 66		09.10 09.10 09.10 09.10 09.10 01.12 02.11 09.10 09.10 09.12 09.10 09.10 09.10 09.10			G1020796	24289 16,9 +/WD/Acc/S LUC
	Cooper Cooper Cooper Cooper D Cooper S Cooper S Cooper SD One One One One D	85 88 90   128 147  55 70 72 66		03.10 11.06 03.10 04.07 03.10 11.06 01.12 02.11 03.09 04.07 03.10 03.10			G2110271	259 10,0 8,4 +C
<b>MINI R57 Convertible (09-)</b>								
	Cooper Cooper Cooper D Cooper SD One	90 82 105 72		01.09 03.10 06.10 02.11 03.10			G1020794	23915 17,6 +/WD/Acc/S LUC
	Cooper S Cooper S	128		03.10 01.09			G1020856	23984 17,8 +/WD/Acc/S LUC
	Cooper Cooper Cooper D Cooper S Cooper S John Cooper Works One	90 82 128 155 72		01.09 08.10 03.10 08.10 06.10 08.10 03.10 08.10 01.09 08.10 03.09 08.10 03.10 08.10			G1020796	24289 16,9 +/WD/Acc/S LUC
	Cooper Cooper Cooper D Cooper S Cooper S Cooper SD John Cooper Works One	90 82 128 105 155 72		09.10 09.10 09.10 09.10 02.11 09.10 09.10			G1020796	24289 16,9 +/WD/Acc/S LUC
	Cooper Cooper Cooper D Cooper S Cooper S Cooper SD One	90 82 128 105 72		01.09 03.10 06.10 03.10 01.09 02.11 03.10			G2110271	259 10,0 8,4 +C
<b>MINI R58 Coupe (11-)</b>								
	Cooper Cooper SD Cooper S			10.11 10.11 10.11			G1020794 G1020856	23915 17,6 +/WD/Acc/S LUC 23984 17,8 +/WD/Acc/S LUC
	Cooper Cooper S Cooper S JCW Cooper SD	155		10.11 10.11 10.11 10.11			G1020796	24289 16,9 +/WD/Acc/S LUC

								
<b>MINI R58 Coupe (11-)</b>								
	Cooper Cooper S Cooper SD		10.11 10.11 10.11		G2110271			259 10,0 8,4 +C
<b>MINI R59 Roadster (12-)</b>								
	Cooper Cooper SD		02.12 02.12		G1020794			23915 17,6 +/WD/Acc/S LUC
	Cooper S		02.12		G1020856			23984 17,8 +/WD/Acc/S LUC
	Cooper Cooper S Cooper S JCW Cooper SD	155	02.12 02.12 02.12 02.12		G1020796			24289 16,9 +/WD/Acc/S LUC
	Cooper Cooper S Cooper SD		02.12 02.12 02.12		G2110271			259 10,0 8,4 +C
<b>MINI R60 Countryman (10-)</b>								
	Cooper Cooper D Cooper S Cooper S Cooper S All4 Cooper S JCW Cooper SD Cooper SD All4 Cooper D All4 One One D	90 82 135 147 160 105 82 72 66	09.10 09.10 09.10 02.12 09.10 09.12 02.11 02.11 09.10 09.10 09.10		G1020856			23984 17,8 +/WD/Acc/S LUC
	Cooper Cooper D Cooper S Cooper S Cooper S All4 Cooper S JCW Cooper SD Cooper SD All4 Cooper D All4 One One D	90 82 135 147 160 105 82 72 66	09.10 09.10 09.10 02.12 09.10 09.12 02.11 02.11 09.10 09.10 09.10		G1020844			23623 17,4 +/WD/Acc/S LUC
<b>MINI R61 Paceman (12-)</b>								
	Cooper Cooper D Cooper D All4 Cooper S Cooper S All4 Cooper S JCW Cooper SD Cooper SD All4	90 82 82 135 135 160 105 105	11.12 11.12 11.12 11.12 11.12 11.12 11.12 11.12		G1020856			23984 17,8 +/WD/Acc/S LUC
	Cooper Cooper D Cooper D All4 Cooper S Cooper S All4 Cooper S JCW Cooper SD Cooper SD All4	90 82 82 135 135 160 105 105	11.12 11.12 11.12 11.12 11.12 11.12 11.12 11.12		G1020844			23623 17,4 +/WD/Acc/S LUC
<b>MITSUBISHI ASX (10-)</b>								
	1.6 i 16V 1.6 i 16V 1.8 DI-D 1.8 DI-D 1.8 DI-D 4WD 1.8 DI-D 4WD 1.8 i 16V 1.8 i 16V 4WD 2.0 i 16V 2.0 i 16V 2.0 i 16V 4WD 2.0 i 16V 4WD	85 86 85 110 85 110 102 102 110 118 110 118	06.10 06.10 06.10 06.10 06.10 06.10 02.10 02.10 06.10 06.10 06.10 06.10		G1205241			23584 16,4 /WI AKE
	1.6 i 16V 1.6 i 16V 1.8 DI-D 1.8 DI-D 1.8 DI-D 4WD 1.8 DI-D 4WD 1.8 i 16V 1.8 i 16V 4WD 2.0 i 16V 2.0 i 16V 2.0 i 16V 4WD 2.0 i 16V 4WD	85 86 85 110 85 110 102 102 110 118 110 118	06.10 06.12 06.10 06.12 06.10 06.12 06.10 06.12 06.10 06.12 06.10 06.12 02.10 06.12 02.10 06.12 06.10 06.12 06.10 06.12 06.10 06.12 06.10 06.12		G1205230			23582 16,0 +

											
<b>MITSUBISHI CARISMA (95-06)</b>											
	1.6 i (DA1A)	66		03.99	06.00	G1020457	21920 14,6 /NI/Acc/S	LUC			
	1.6 i 16V (DA1A)	76		06.99	08.00						
	1.8 i (DA2A)	85		07.95	06.98						
	1.8 i 16V (DA2A)	103		07.95	06.98						
	1.8 i 16V GDI (DA2A)	92		09.97	08.00						
	1.9 TD (DA4A)	66		03.99	09.00						
	1.3 i (DA6A)	55		09.00	10.04				G1020537	21983 17,2 /NI/Acc/S	LUC
	1.6 i (DA1A)	66		07.00	06.06						
	1.6 i 16V (DA1A)	76		09.00	06.06						
	1.8 i (DA2A)	85		07.98	06.06						
1.8 i 16V (DA2A)	103		07.98	06.06							
1.8 i 16V GDI (DA2A)	90		10.00	06.06							
1.8 i 16V GDI (DA2A)	92		09.00	06.06							
1.9 DI-D (DA5A)	75		09.00	06.06							
1.9 DI-D (DA5A)	85		09.00	06.06							
	1.3 i (DA6A)	55		09.00	10.04	G1020458	21861 15,2 /NI/S	LUC			
	1.6 i (DA1A)	66		06.99	06.06 + ABS						
	1.6 i 16V (DA1A)	76		09.00	06.06 + ABS						
	1.8 i (DA2A)	85		11.97	06.06 + ABS						
	1.8 i 16V (DA2A)	103		11.97	06.06 + ABS						
	1.8 i 16V GDI (DA2A)	90		10.00	06.06 + ABS						
	1.8 i 16V GDI (DA2A)	92		06.99	06.06 + ABS						
	1.9 DI-D (DA5A)	75		09.00	06.06						
	1.9 DI-D (DA5A)	85		09.00	06.06						
		1.3 i (DA6A)	55		09.00				10.04	G2110229	260 10,0 8,4 +C
1.6 i (DA1A)		66		06.99	06.06 + ABS						
1.6 i 16V (DA1A)		76		09.00	06.06 + ABS						
1.8 i (DA2A)		85		07.95	06.06 + ABS						
1.8 i 16V (DA2A)		103		07.95	06.06 + ABS						
1.8 i 16V GDI (DA2A)		90		10.00	06.06 + ABS						
1.8 i 16V GDI (DA2A)		92		08.97	06.06 + ABS						
1.9 DI-D (DA5A)		75		09.00	06.06						
1.9 DI-D (DA5A)		85		09.00	06.06						
<b>MITSUBISHI COLT (04-)</b>											
	1.1 i 12V (Z32A)	55		10.04		G1020779	21920 16,6 /NI/Acc/S	LUC			
	1.3 i 16V (Z34A)	70		06.04							
	1.5 DI-D (Z38A)	50		08.04							
	1.5 DI-D (Z39A)	70		08.04							
	1.5 i 16V (Z27A)	72		09.04	02.06						
	1.5 i 16V (Z36A)	80		06.04							
	1.5 CZT (Z37A)	110		03.05	08.08	G1020537	21983 17,2 /NI/Acc/S	LUC			
	1.5 i 16V (Z37A)	132		05.07	08.08						
	1.1 i 12V (Z32A)	55		10.04	+ ABS	G1020458	21861 15,2 /NI/S	LUC			
	1.3 i 16V (Z34A)	70		06.04	+ ABS						
	1.5 CZT (Z37A)	110		03.05	+ ABS						
	1.5 DI-D (Z38A)	50		08.04	+ ABS						
	1.5 DI-D (Z39A)	70		08.04	+ ABS						
	1.5 i 16V (Z27A)	72		09.04	02.06						
	1.5 i 16V (Z36A)	80		06.04							
	1.5 i 16V (Z37A)	132		05.07							
<b>MITSUBISHI COLT CZC Convertible (06-08)</b>											
	1.5 i 16V (Z36A)	80		05.06	07.08	G1020779	21920 16,6 /NI/Acc/S	LUC			
	1.5 Turbo (Z37A)	110		05.06	07.08						
	1.5 i 16V (Z36A)	80		05.06	07.08	G1020458	21861 15,2 /NI/S	LUC			
	1.5 Turbo (Z37A)	110		05.06	07.08						
<b>MITSUBISHI GALANT (96-03)</b>											
	2.0 i 16V (EA2)	98		04.00	10.03	G1205241	23584 16,4 /NI	AKE			
	2.0 i 16V (EA2)	100		04.00	10.03						
	2.0 i 16V (EA2W)	98		04.00	10.03						
	2.0 i 16V (EA2W)	100		04.00	10.03						
	2.4 GDi (EA3)	106		04.00	10.03						
	2.4 GDi (EA3)	110		04.00	10.03						
	2.5 i V6 (EA5)	118		04.00	10.03						
2.5 i V6 (EA5)	120		04.00	10.03							
<b>MITSUBISHI GALANT Notchback (03-)</b>											
	2.4 GDi	116		10.03		G1205241	23584 16,4 /NI	AKE			
<b>MITSUBISHI GRANDIS (04-10)</b>											
	2.0 DI-D (NA8W)	100		09.05	08.10	G1205230	23582 16,0 +				
	2.0 DI-D (NA8W)	103		02.07	08.10						
	2.4 16V (NA4W)	121		04.04	08.10						
	2.4 16V (NA4W)	130		04.04	08.10						

									
<b>MITSUBISHI LANCER Evolution (04-07)</b>									
	2.0 i 16V (CT9A)	206		01.06	08.07		G1205241	23584 16,4 /Wl	AKE
<b>MITSUBISHI LANCER Evolution (CZ_A) (07-)</b>									
	2.0 i 16V (CZ4A)	294		06.09			G1205230	23582 16,0 +	
<b>MITSUBISHI LANCER Saloon (03-07)</b>									
	1.3 i 16V (CS1A)	60		09.03	03.07		G1205241	23584 16,4 /Wl	AKE
	1.6 i 16V (CS3A)	72		09.03	03.07				
	2.0 i 16V (CS9A)	99		12.03	03.07				
<b>MITSUBISHI LANCER Estate (03-07)</b>									
	1.6 i 16V (CS3W)	72		09.03	03.07		G1205241	23584 16,4 /Wl	AKE
	2.0 i 16V (CS9W)	99		09.03	03.07				
	2.4 i 16V (CS9W)	98		09.03	03.07				
<b>MITSUBISHI LANCER Notchback/Sport Saloon (CY_A) (07-)</b>									
	1.5 16V (CY2A)	80		06.08			G1205241	23584 16,4 /Wl	AKE
	1.6 16V ((CY1A)	86		05.10					
	1.8 16V (CY3A)	103		05.10					
	1.8 16V (CY3A)	105		02.08					
	1.8 16V Flex (CY3A)	103		03.09					
	1.8 DI-D (CY9A)	85		05.10					
	1.8 DI-D (CY9A)	110		06.10					
	2.0 16V (CY4A)	108		01.09					
	2.0 16V (CY4A)	113		10.07					
	2.0 16V Turbo (CY4A)	177		10.08					
	2.0 DI-D (CY8A)	103		01.08					
<b>MITSUBISHI LANCER Sportback (CX_A) (08-)</b>									
	1.5 16V (CX2A)	80		06.08			G1205241	23584 16,4 /Wl	AKE
	1.6 16V (CX1A)	86		05.10					
	1.8 16V (CX3A)	103		03.09					
	1.8 16V (CX3A)	105		06.08					
	1.8 16V Flex (CX3A)	103		03.09					
	1.8 DI-D (CX9A)	85		05.10					
	1.8 DI-D (CX9A)	110		06.10					
	2.0 DI-D (CX8A)	103		06.08					
	2.0 16V Turbo (CX4A)	177		10.08			G1205230	23582 16,0 +	
<b>MITSUBISHI OUTLANDER II (06-)</b>									
	2.0 DI-D	103		01.07			G1205230	23582 16,0 +	
	2.2 DI-D	115		08.07					
	2.2 DI-D 4x4	115		08.07					
	3.0 V6 4x4	162		11.06					
<b>MITSUBISHI OUTLANDER III (12-)</b>									
	2.4 16V 4WD	123		10.12			G1205241	23584 16,4 /Wl	AKE
<b>MITSUBISHI PAJERO (00-07)</b>									
	2.5 TDiC (V64W)	73		04.00	01.07		G1205230	23582 16,0 +	
	2.5 TDiC (V64W)	85		04.00	01.07				
	3.2 DiD (V68W)	118		10.01	08.06				
	3.2 DiD (V68W)	121		04.00	09.01				
	3.5 i V6 GDI (V65W)	149		04.00	08.06				
<b>MITSUBISHI PAJERO (07-)</b>									
	3.0 i V6 (V93W)	131		02.07			G1205333	24024 17,0 +/Wl	
	3.2 DI-D (V98W)	118		02.07					
	3.2 DI-D (V98W)	125		02.07					
	3.2 TD 4x4 (V98W)	147		01.09					
	3.8 i V6 (V97W)	182		02.10					
	3.8 i V6 (V97W)	184		02.07					
	3.2 4x4 (V88W)	140		02.07			G1205230	23582 16,0 +	
	3.2 DI-D (V88W)	118		02.07					
	3.2 DI-D (V88W)	125		02.07					
	3.2 TD 4x4 (V88W)	147		01.09					
	3.8 i V6 (V87W)	182		02.10					
	3.8 i V6 (V87W)	184		02.07					
	3.0 i V6 (V93W)	131		02.07			G1205404	21947 15,4	
	3.2 DI-D (V98W)	118		02.07					
	3.2 DI-D (V98W)	125		02.07					
	3.2 TD 4x4 (V98W)	147		01.09					
	3.8 i V6 (V97W)	182		02.10					
	3.8 i V6 (V97W)	184		02.07					

								
<b>MITSUBISHI SPACE RUNNER (99-03)</b>								
	2.0 i 16V (N63W) 2.4 16V GDI (N64W)	100 110		05.00 05.00	04.03 04.03		G1205241	23584 16,4 /W/ AKE
<b>MITSUBISHI SPACE STAR (98-06)</b>								
	1.3 i (DG1A) 1.3 i (DG1A) 1.3 i (DG1A) 1.6 i 16V (DG3A) 1.8 GDI (DG5A) 1.8 GDI (DG5A) 1.9 DI-D (DG4A) 1.9 DI-D (DG4A)	60 61 63 72 82 90 75 85		08.00 12.98 06.98 09.01 10.02 06.98 02.01 10.02	03.06 03.06 07.00 03.06 03.06 03.06 03.06 03.06		G1020457	21920 14,6 /W/ Acc/S LUC
	1.3 i (DG1A) 1.3 i (DG1A) 1.3 i (DG1A) 1.6 i 16V (DG3A) 1.8 GDI (DG5A) 1.8 GDI (DG5A) 1.9 DI-D (DG4A) 1.9 DI-D (DG4A)	60 61 63 72 82 90 75 85		08.00 12.98 06.98 09.01 10.02 06.98 02.01 10.02	03.06 + ABS 03.06 + ABS 07.00 + ABS 03.06 03.06 + ABS 03.06 + ABS 03.06 03.06		G1020458	21861 15,2 /W/ S LUC
	1.3 i (DG1A) 1.3 i (DG1A) 1.3 i (DG1A) 1.6 i 16V (DG3A) 1.8 GDI (DG5A) 1.8 GDI (DG5A) 1.9 DI-D (DG4A) 1.9 DI-D (DG4A)	60 61 63 72 82 90 75 85		08.00 12.98 06.98 09.01 10.02 06.98 02.01 10.02	03.06 + ABS 03.06 + ABS 07.00 + ABS 03.06 03.06 + ABS 03.06 + ABS 03.06 03.06		G2110229	260 10,0 8,4 +C
<b>NISSAN ALMERA (N16) (00-06)</b>								
	1.5 dCi 1.5 i 1.5 i 1.5 i 1.8 i 1.8 i 1.8 i 2.2 dCi 2.2 dCi 2.2 Di 2.2 Di	60 66 66 72 84 84 85 82 100 81 81		01.03 03.00 02.00 10.02 03.00 02.00 10.02 09.03 09.03 03.00 02.00	11.06 + ABS + ABS/ country of manufacture <sup>1)</sup> + ABS + ABS country of manufacture <sup>2)</sup> 11.06 11.06 11.06 11.06 11.06 country of manufacture <sup>2)</sup> 11.06		G2110215	258 10,0 9,0 +C
<b>NISSAN ALMERA TINO (V10M) (00-05)</b>								
	1.6 i 16V 1.8 i 16V 1.8 i 16V 2.0 i 16V 2.2 dCi 2.2 dCi 2.2 Di	71 84 85 100 82 100 84		08.00 08.00 12.02 08.00 09.03 09.03 08.00	11.05 - <sup>Ⓧ</sup> 11.05 11.05 08.03 11.05 11.05 08.03		G2110285	278 10,0 9,0 +C
<b>NISSAN INTERSTAR (X70) (02-10)</b>								
	1.9 dCi 2.2 dCi 2.5 dCi 2.5 dCi 2.5 dCi 2.5 dCi 2.5 dCi 2.5 dCi 3.0 dCi	60 66 73 74 84 88 107 100		07.02 07.02 11.03 04.06 07.02 09.06 09.06 11.03	08.06 08.06 06.10 06.10 08.06 06.10 06.10 08.06		G1020624	23613 17,7 BOS
	1.9 dCi 2.2 dCi 2.5 dCi 2.5 dCi 2.5 dCi 2.5 dCi 2.5 dCi 2.5 dCi 3.0 dCi	60 66 73 74 84 88 107 100		07.02 07.02 11.03 04.06 07.02 09.06 09.06 11.03	08.06 08.06 06.10 06.10 08.06 06.10 06.10 08.06		G1020627	23669 16,8 /S BOS
	1.9 dCi 2.2 dCi 2.5 dCi 2.5 dCi 2.5 dCi 2.5 dCi 2.5 dCi 2.5 dCi 3.0 dCi	60 66 73 74 84 88 107 100		07.02 07.02 11.03 04.06 07.02 09.06 09.06 11.03	08.06 08.06 06.10 06.10 08.06 06.10 06.10 08.06		G2112155	305 12,0 10,5 +S +C
<b>NISSAN JUKE (F15) (10-)</b>								
	1.5 dCi 1.6 16V 1.6 DIG-T 1.6 DIG-T 1.6 DIG-T 4x4	81 86 140 147 140		06.10 06.10 06.10 11.12 06.10			G2109157	292 9,0 8,0 +C

<sup>1)</sup> + ABS/ paese del costruttore <sup>Ⓧ</sup> / + ABS/ pays du constructeur <sup>Ⓧ</sup> / + ABS/ país del fabricante <sup>Ⓧ</sup> / + ABS/ Herst.Land <sup>Ⓧ</sup>

<sup>2)</sup> paese del costruttore <sup>Ⓧ</sup> / pays du constructeur <sup>Ⓧ</sup> / país del fabricante <sup>Ⓧ</sup> / Herst.Land <sup>Ⓧ</sup>

<sup>3)</sup> paese del costruttore <sup>Ⓧ</sup> / pays du constructeur <sup>Ⓧ</sup> / país del fabricante <sup>Ⓧ</sup> / Herst.Land <sup>Ⓧ</sup>





















<b>NISSAN KUBISTAR (X76) Estate (03-09)</b>																			
	1.2	44		08.03	08.05	G1020497											21980 18,0 +WD/S	BOS	
	1.2	55		08.03	10.09														
	1.5 dCi	42		08.03	08.05														
	1.5 dCi	44		09.05	10.09														
	1.5 dCi	48		08.03	08.05														
	1.5 dCi	51		09.05	10.09														
	1.5 dCi	60		08.03	08.05														
	1.5 dCi	66		09.05	10.09														
1.6 i 16V	70		08.03	10.09															
	1.2	44		08.03	08.05	G2121106											259 20,6 17,7 V +S +C		
	1.2	55		08.03	10.09														
	1.5 dCi	42		08.03	08.05														
	1.5 dCi	44		09.05	10.09														
	1.5 dCi	48		08.03	08.05														
	1.5 dCi	51		09.05	10.09														
	1.5 dCi	60		08.03	08.05														
	1.5 dCi	66		09.05	10.09														
1.6 i 16V	70		08.03	10.09															
	1.2	44		08.03	08.05	G2120125											238 20,1 17,7 V +S +C		
	1.2	55		08.03	10.09														
	1.5 dCi	42		08.03	08.05														
	1.5 dCi	44		09.05	10.09														
	1.5 dCi	48		08.03	08.05														
	1.5 dCi	51		09.05	10.09														
	1.5 dCi	60		08.03	08.05														
	1.5 dCi	66		09.05	10.09														
1.6 i 16V	70		08.03	10.09															
<b>NISSAN MICRA (K11E) (92-02)</b>																			
	1.0 i 16V	40		08.92	07.00 - ABS	G2112137												234 12,0 10,0 +C	
	1.0 i 16V	44		08.00	12.02 - ABS														
	1.3 i 16V	55		08.92	07.00 - ABS														
	1.4 i 16V	60		08.00	12.02 - ABS														
	1.5 D	42		02.98	12.02 - ABS														
	1.0 i 16V	40		08.92	08.00 + ABS	G2107109												240 7,0 6,0 +C	
	1.0 i 16V	44		09.00	12.02 + ABS														
	1.3 i 16V	55		08.92	08.00 + ABS														
	1.4 i 16V	60		09.00	12.02 + ABS														
<b>NISSAN MICRA (K12E) (03-10)</b>																			
	1.0 i 16V	48		01.03	06.10	G1020538												23973 17,2 /S	LUC
	1.2 i 16V	48		01.03	06.10														
	1.2 i 16V	59		01.03	06.10														
	1.4 i 16V	65		01.03	06.10														
	1.5 dCi	48		01.03	06.10														
	1.5 dCi	50		06.05	06.10														
	1.5 dCi	60		09.03	06.10														
	1.5 dCi	63		01.03	06.10														
1.6 i 16V	81		05.05	06.10															
	1.0 i 16V	48		01.03	06.10	G2122216												260 22,0 19,8 V L +S +C	
	1.2 i 16V	48		01.03	06.10														
	1.2 i 16V	59		01.03	06.10														
	1.4 i 16V	65		01.03	06.10														
	1.5 dCi	48		01.03	06.10														
	1.5 dCi	50		06.05	06.10														
	1.5 dCi	60		09.03	06.10														
	1.5 dCi	63		01.03	06.10														
1.6 i 16V	81		05.05	06.10															
<b>NISSAN MICRA C+C (CK12E) (05-10)</b>																			
	1.4 i 16V	65		08.05	12.10	G1020538												23973 17,2 /S	LUC
	1.6 i 16V	81		08.05	12.10														
	1.4 i 16V	65		08.05	12.10	G2122216												260 22,0 19,8 V L +S +C	
	1.6 i 16V	81		08.05	12.10														
<b>NISSAN MICRA (K13K) (10-)</b>																			
	1.2 DIG	72		04.11		G1201059												24403 17,2 +/Wl	LUC
	1.2 i	56		05.10															
	1.2 i	59		05.10															
<b>NISSAN MURANO (Z50) (03-08)</b>																			
	3.5 i V6	172		10.03	06.08	G1201029												23698 16,8 +/Wl	SUM
	3.5 i V6	180		10.03	06.08														
	3.5 i V6 4x4	172		10.03	06.08														
	3.5 i V6 4x4	180		10.03	06.08														
<b>NISSAN NAVARA (D40M) (05-)</b>																			
	2.5 dCi	106		07.05		G1201029												23698 16,8 +/Wl	SUM
	2.5 dCi	120		10.06															
	2.5 dCi	128		12.05															
	2.5 dCi 4WD	126		10.06															
	2.5 dCi 4WD	128		07.05															
	2.5 dCi 4WD	140		12.09															

1) + servofreno da 8" / + frein de 8" / + freno de 8" / + 8" Bremse

















2) + servofreno da 9" / + frein de 9" / + freno de 9" / + 9" Bremse





















3) + ruota 17" / + roue 17" / + rueda 17" / + 17" Rad



	 kW							
<b>NISSAN NOTE (E11E) (06-13)</b>								
	1.4 1.5 dCi 1.5 dCi 1.5 dCi 1.5 dCi 1.6	65 50 63 66 76 81		03.06 03.06 03.06 09.10 07.08 03.06	05.13 05.13 05.13 05.13 05.13 05.13	G1020741		23973 17,1 /Acc/S LUC
	1.4 1.5 dCi 1.5 dCi 1.5 dCi 1.5 dCi 1.6	65 50 63 66 76 81		03.06 03.06 03.06 09.10 07.08 03.06	05.13 05.13 05.13 05.13 05.13 05.13	G2122216		260 22,0 19,8 V L +S +C
<b>NISSAN PATHFINDER (R51M) (05-)</b>								
	2.5 dCi 2.5 dCi 4WD 2.5 dCi 4WD 4.0 4.0 4WD	128 126 128 198 198		01.05 10.06 03.05 01.05 09.05		G1201029	+ 17" wheel <sup>1)</sup>	23698 16,8 +/-WI SUM
<b>NISSAN PRIMASTAR (X83) Bus (01-)</b>								
	1.9 dCi (100) 1.9 dCi (80) 2.0 dCi (115) 2.0 dCi (120) 2.0 dCi (90) 2.0 i 16V 2.5 dCi (140) 2.5 dCi (150)	74 60 84 84 66 88 99 107		03.01 03.01 09.08 09.06 09.06 03.01 07.03 09.06	08.06 08.06    08.06	G1020633		23099 18,4 /S LUC
	1.9 dCi (100) 1.9 dCi (80) 2.0 dCi (115) 2.0 dCi (120) 2.0 dCi (90) 2.0 i 16V 2.5 dCi (140) 2.5 dCi (150)	74 60 84 84 66 88 99 107		03.01 03.01 09.08 09.06 09.06 03.01 07.03 09.06	08.06 08.06    08.06	G2128132		305 28,0 24,0 V L +S +C
	1.9 dCi (100) 1.9 dCi (80) 2.0 dCi (115) 2.0 dCi (120) 2.0 dCi (90) 2.0 i 16V 2.5 dCi (140) 2.5 dCi (150)	74 60 84 84 66 88 99 107		03.01 03.01 09.08 09.06 09.06 03.01 07.03 09.06	08.06 08.06    08.06	G1020529		23980 16,5 /WD/S LUC
<b>NISSAN PRIMASTAR (X83) Van/Pickup (02-)</b>								
	1.9 dCi (100) 1.9 dCi (80) 2.0 dCi (115) 2.0 dCi (120) 2.0 dCi (90) 2.0 i 16V 2.5 dCi (140) 2.5 dCi (150)	74 60 84 84 66 88 99 107		07.02 07.02 09.08 09.06 09.06 07.02 07.03 09.06	08.06 08.06    08.06	G1020633		23099 18,4 /S LUC
	1.9 dCi (100) 1.9 dCi (80) 2.0 dCi (115) 2.0 dCi (120) 2.0 dCi (90) 2.0 i 16V 2.5 dCi (140) 2.5 dCi (150)	74 60 84 84 66 88 99 107		07.02 07.02 09.08 09.06 09.06 07.02 07.03 09.06	08.06 08.06    08.06	G2128132		305 28,0 24,0 V L +S +C
	1.9 dCi (100) 1.9 dCi (80) 2.0 dCi (115) 2.0 dCi (120) 2.0 dCi (90) 2.0 i 16V 2.5 dCi (140) 2.5 dCi (150)	74 60 84 84 66 88 99 107		07.02 07.02 09.08 09.06 09.06 07.02 07.03 09.06	08.06 08.06    08.06	G1020529		23980 16,5 /WD/S LUC
<b>NISSAN PRIMERA (P10E) Saloon (90-96)</b>								
	1.6 1.6 i 2.0 D 2.0 i 16V 2.0 i 16V 4x4			05.93 05.93 05.93 06.90 06.90	01.96 + ABS 01.96 + ABS 01.96 01.96 01.96	G2110215		258 10,0 9,0 +C
<b>NISSAN PRIMERA (P11E) Saloon (96-02)</b>								
	2.0 i 16V 2.0 i 16V 2.0 i 16V 2.0 i 16V	85 96 103 110		06.96 06.96 06.99 06.96	05.99 05.99 02.02 05.99	G2110215		258 10,0 9,0 +C

<sup>1)</sup> + ruota 17" / + roue 17" / + rueda 17" / + 17" Rad

							
<b>NISSAN PRIMERA (P12E) Saloon (02-08)</b>							
	1.6	78		03.02	10.08	G1020470	23482 15,8 +WD ATE
	1.6	80		03.02	04.06		
	1.8	85		03.02	10.08		
	1.9 dCi	88		04.03	10.07		
	2.0	103		03.02	10.08		
	2.2 dCi	102		04.03	10.07		
	2.2 Di	93		03.02	04.03		
	2.5	125		03.02	04.06		
	1.6	78		03.02	10.08	G2110285	278 10,0 9,0 +C
	1.6	80		03.02	04.06		
	1.8	85		03.02	10.08		
	1.9 dCi	88		04.03	10.07		
	2.0	103		03.02	10.08		
	2.2 dCi	102		04.03	10.07		
	2.2 Di	93		03.02	04.03		
	2.5	125		03.02	04.06		
<b>NISSAN PRIMERA (W11) Estate (98-02)</b>							
	1.6 i 16V	66		04.01	02.02	G2110215	258 10,0 9,0 +C
	1.6 i 16V	73		04.01	02.02		
	1.8 i 16V	84		04.01	02.02		
	2.0 i 16V	85		04.01	02.02		
	2.0 i 16V	96		04.01	02.02		
	2.0 i 16V	103		04.01	02.02		
	2.0 TD	66		04.01	02.02		
<b>NISSAN PRIMERA (W12) Estate (02-08)</b>							
	1.6	78		03.02	10.08	G1020470	23482 15,8 +WD ATE
	1.6	80		03.02	04.06		
	1.8	85		03.02	10.08		
	1.9 dCi	88		04.03	10.07		
	2.0	103		03.02	10.08		
	2.2 dCi	102		04.03	10.07		
	2.2 Di	93		03.02	04.03		
	2.5	125		03.02	04.06		
	1.6	78		03.02	10.08	G2110285	278 10,0 9,0 +C
	1.6	80		03.02	04.06		
	1.8	85		03.02	10.08		
	1.9 dCi	88		04.03	10.07		
	2.0	103		03.02	10.08		
	2.2 dCi	102		04.03	10.07		
	2.2 Di	93		03.02	04.03		
	2.5	125		03.02	04.06		
<b>NISSAN QASHQAI / QASHQAI +2 (J10,JJ10) (07-)</b>							
	1.5 dCi	76		07.08		G1020866	24632 17,0
	1.5 dCi	78		02.07			
	1.5 dCi	81		11.10			
	1.6 dCi	96		10.11			
	1.6 dCi Allrad	96		10.11			
	1.6 i 16V	84		02.07			
	1.6 i 16V	86		11.10			
	2.0 dCi	110		02.07			
	2.0 dCi Allrad	110		02.07			
	2.0 i 16V	103		02.07			
	2.0 i 16V	104		11.10			
	2.0 i 16V Allrad	103		02.07			
	2.0 i 16V Allrad	104		11.10			
	1.5 dCi	76		07.08		G2126154	296 26,0 24,0 V +C
	1.5 dCi	78		02.07			
	1.5 dCi	81		11.10			
	1.6 dCi	96		10.11			
	1.6 dCi Allrad	96		10.11			
	1.6 i 16V	84		02.07			
	1.6 i 16V	86		11.10			
	2.0 dCi	110		02.07			
	2.0 dCi Allrad	110		02.07			
	2.0 i 16V	103		02.07			
	2.0 i 16V	104		11.10			
	2.0 i 16V Allrad	103		02.07			
	2.0 i 16V Allrad	104		11.10			
	1.5 dCi	76		07.08		G2109157	292 9,0 8,0 +C
	1.5 dCi	78		02.07			
	1.5 dCi	81		11.10			
	1.6 dCi	96		10.11			
	1.6 dCi Allrad	96		10.11			
	1.6 i 16V	84		02.07			
	1.6 i 16V	86		11.10			
	2.0 dCi	110		02.07			
	2.0 dCi Allrad	110		02.07			
	2.0 i 16V	103		02.07			
	2.0 i 16V	104		11.10			
	2.0 i 16V Allrad	103		02.07			
	2.0 i 16V Allrad	104		11.10			

	 kW							
<b>NISSAN X-TRAIL (T31) (07-)</b>								
	2.0 2.0 2.0 dCi 2.0 dCi 2.0 dCi FWD 2.0 FWD 2.0 FWD 2.5	103 104 110 127 110 103 104 124		06.08 06.07 06.07 06.07 06.07 06.08 03.07 06.07	03.10 03.10 03.10 03.10 03.10 03.10 03.10 03.10	G1020866		24632 17,0
	2.0 2.0 2.0 dCi 2.0 dCi 2.0 dCi 4x4 2.0 dCi FWD 2.0 FWD 2.0 FWD 2.5	103 104 110 127 130 110 103 104 124		06.08 06.07 06.07 06.07 10.09 06.07 06.08 03.07 06.07	12.10 12.10 12.10 12.10 12.10 12.10 12.10 12.10 12.10	G2126154		296 26,0 24,0 V +C
<b>OPEL ADAM / Vauxhall Adam (13-)</b>								
	1.0 1.2 1.2 ecoFLEX 1.4 ecoFLEX 1.4 ecoFLEX 1.4 LPG	50 69 51 64 74 64		07.13 07.13 01.13 01.13 01.13 07.13		G1020858		24288 18,0 +/Wl/Acc/S BOS
	1.0 1.2 1.2 ecoFLEX 1.4 ecoFLEX 1.4 ecoFLEX 1.4 LPG	50 69 51 64 74 64		07.13 07.13 01.13 01.13 01.13 07.13		G2122231		257 22,0 20,0 V +S +C
<b>OPEL AGILA / Vauxhall Agila Mk I (00-07)</b>								
	1.0 1.0 12V 1.2 16V 1.2 16V Twinport 1.3 CDTI	44 43 55 59 51		08.03 09.00 09.00 07.04 08.03	07.07 07.07 07.07 07.07 07.07	G1020605		23605 15,7 +/Wl/Acc/S BOS
<b>OPEL AGILA / Vauxhall Agila Mk II (08-)</b>								
	1.0 1.0 1.2 1.2 1.3 CDTI	48 50 63 69 55		01.08 07.11 01.08 11.10 01.08		G1201059		24403 17,2 +/Wl LUC
	1.0 1.0 1.2 1.2 1.3 CDTI	48 50 63 69 55		01.08 07.11 01.08 11.10 01.08		G2120211		252 20,0 18,0 V +S +C
<b>OPEL ANTARA / Vauxhall Antara (06-)</b>								
	2.0 CDTi 4x4 2.0 CDTi 4x4 2.0 CDTi FWD 2.0 CDTi FWD 2.2 CDTi 4x4 2.2 CDTi 4x4 2.2 CDTi FWD 2.4 2.4 4x4 2.4 4x4 2.4 FWD 2.4 FWD 3.0 4X4 3.2 V6	93 110 93 110 120 135 120 104 103 123 103 123 190 167		03.07 07.06 09.08 08.06 12.10 12.10 12.10 07.06 01.07 12.10 09.08 12.10 12.10 07.06		G1020979		24510 17,0 +/Wl
	2.0 CDTi 4x4 2.0 CDTi 4x4 2.0 CDTi FWD 2.0 CDTi FWD 2.2 CDTi 4x4 2.2 CDTi FWD 2.4 2.4 4x4 2.4 4x4 2.4 FWD 2.4 FWD 3.0 4X4 3.2 V6	93 110 93 110 120 120 104 103 123 103 123 190 167		03.07 07.06 09.08 08.06 12.10 12.10 07.06 01.07 12.10 09.08 12.10 12.10 07.06		G1020981		24498 14,7 +/Wl/Acc
<b>OPEL AMPERA / Vauxhall Ampera (11-)</b>								
	EV 150	111		11.11		G1020928		24034 19,1 +/Wl/Acc
	EV 150	111		11.11		G1020953	electric parking brake <sup>1)</sup>	25096 17,0 +/Wl/Acc ATE

<sup>1)</sup> fr.di stazionamento elettrico / frein à main électrique / freno de mano eléctrico / elektrische Feststellbremse



**OPEL ASTRA F / Vauxhall Astra MKIII (91-01)**

	1.4 Convertible			10.91	03.01	G1020317	20547 16,5 +/WD	ATE				
	1.4 N			10.91	09.98							
	1.4 S			10.91	09.98				- heavy duty brake <sup>1)</sup>			
	1.6 Convertible			10.91	03.01							
	1.6 N			10.91	09.98				+ engine code C16NZ / X16SZR <sup>2)</sup>			
	1.6 N Caravan			10.91	09.98							
	1.6 Si			03.92	12.94							
	1.7 D			10.91	09.98				- heavy duty brake <sup>1)</sup>			
	1.7 TD			10.91	09.98				- heavy duty brake <sup>1)</sup>			
	1.8			10.91	09.98							
	1.4 S			10.91	09.98	+ heavy duty brake <sup>3)</sup>	G1020258	21190 17,5 +/WD	ATE			
	1.6			10.91	09.98	- Motorcode C16NZ / X16SZR <sup>4)</sup>						
	1.6 16V			02.93	09.98							
	1.6 S			10.91	09.98							
	1.7 D			10.91	09.98	+ heavy duty brake <sup>3)</sup>						
	1.7 TD			10.91	09.98	+ heavy duty brake <sup>3)</sup>						
	1.8 16V			10.91	09.98							
	1.8 Convertible			10.91	03.01							
	2.0			10.91	09.98							
	2.0 Convertible			10.91	10.94							
2.0 GSi			10.91	09.98								
2.0 GSi 16V			10.91	09.98								
	1.4 N			10.91	09.98	G2113161	236 12,7 9,7 +S +C					
	1.4 S			10.91	09.98				- heavy duty br./+ manual trans. <sup>5)</sup>			
	1.6 N Saloon	T5000073		10.91	09.98				+ manual transmission <sup>6)</sup>			
	1.4 Convertible			10.91	03.01				G2120115	236 20,0 17,0 V L +S +C		
	1.4 S			10.91	09.98							- heavy duty br./+ autom.trans. <sup>7)</sup>
	1.6 Convertible			10.91	03.01							
	1.6 N Caravan			10.91	09.98							
	1.6 N Saloon	T5000074		09.98	+ manual transmission <sup>6)</sup>							
	1.6 N Saloon			10.91	09.98							+ autom.transmission <sup>8)</sup>
	1.6 S			10.91	09.98							
1.6 Si			03.92	12.94								
1.7 D			10.91	09.98	- heavy duty brake <sup>1)</sup>							
1.7 TD			10.91	09.98	- heavy duty brake <sup>1)</sup>							
1.8	66		10.91	09.98	G2120140	256 20,0 17,0 V L +S +C						
	1.4 S			10.91	09.98	+ heavy duty brake <sup>3)</sup>	G2124115	256 24,0 21,0 V L +S +C				
	1.6			10.91	09.98							
	1.6 16V			02.93	09.98							
	1.7 D			10.91	09.98	+ heavy duty brake <sup>3)</sup>						
	1.7 TD			10.91	09.98	+ heavy duty brake <sup>3)</sup>						
	1.8 16V			10.91	09.98							
	1.8 Convertible			10.91	03.01							
	2.0			10.91	09.98							
	2.0 Convertible			10.91	10.94							
	2.0 GSi			10.91	09.98							
2.0 GSi 16V			10.91	09.98								
	1.8 16V			10.91	09.98	G1020272	21140 15,0	ATE				
	2.0 GSi			10.91	09.98							
	2.0 GSi 16V			10.91	09.98							

**OPEL ASTRA G / Vauxhall Astra MKIV (98-04)**

	1.2 16V			04.98	12.04	G1020542	23063 17,5 +/WI	ATE	
	1.4 16V			04.98	12.04				
	1.6			04.98	12.04				
	1.6 16V			04.98	12.04				
	1.6 16V Convertible			03.01	12.04				
	1.7 CDTI			04.03	12.04				
	1.7 DTI			02.00	12.04				
	1.7 TD			04.98	08.00				
	1.8 16V			04.98	12.04				- ABS
	1.8 16V Caravan			04.98	12.04				- ABS
1.8 16V Convertible			03.01	12.04	- ABS				
2.0 DI			04.98	12.04	- ABS				
	1.6 CNG			03.03	12.04	G1020550	23057 20,2 +/WD	ATE	
	1.8 16V			04.98	12.04				+ ABS
	1.8 16V Caravan			04.98	12.04				+ ABS
	1.8 16V Convertible			03.01	12.04				+ ABS
	1.8 16V Coupe			03.00	12.04				
	2.0 16V			04.98	12.04				
	2.0 DI			04.98	12.04				+ ABS
	2.0 DTI 16V			08.99	12.04				
	2.2 16V			09.00	12.04				
	2.2 16V Convertible			03.01	12.04				
2.2 16V Coupe			09.00	12.04					
2.2 DTI 16V			09.02	12.04					
2.2 DTI 16V Convert.			09.02	12.04					
2.2 DTI 16V Coupe			09.02	12.04					
2.0 16V OPC			10.99	12.04	G1020642	23116 19,8 +/WI	ATE		
2.0 16V OPC Convert.			03.02	12.04					
2.0 Turbo			03.00	12.04					
	1.2 16V			04.98	12.04	G2124152	for 4 bore wheel rim <sup>10)</sup>	256 23,8 21,0 V L +S +C	
	1.2 16V	22000001	18999999		12.04				+ RA disc brake <sup>9)</sup>
	1.4 16V			04.98	12.04				
	1.6			04.98	12.04				
	1.6 16V			04.98	12.04				

1) - freno rinforzato / - frein renforcé / - freno reforzado / - verstärkte Bremse  
 2) + codice motore C16NZ / X16SZR / + moteur code C16NZ / X16SZR / + motor code C16NZ / X16SZR / + Motorcode C16NZ / X16SZR  
 3) + freno rinforzato / + frein renforcé / + freno reforzado / + verstärkte Bremse  
 4) - motore no. C16NZ / X16SZR / - moteur no. C16NZ / X16SZR / - motor no. C16NZ / X16SZR / - Motorcode C16NZ / X16SZR  
 5) - fr.rinforzato/+ scatola camb.velocità / - frein renforcé/ + transm.mécanique / - freno reforzado/ + camb.velocidad / - verstärkte Br./+ Schaltgetr.

6) + scatola cambio velocità / + transmission mécanique / + cambio de velocidad / + Schaltgetriebe  
 7) - fr.rinforzato/+ scatola cambio autom. / - frein renforcé/ + transm.automatique / - freno reforzado/ + camb. automatico / - verstärkte Br./+ Automatikg.  
 8) + scatola cambio automatico / + transmission automatique / + cambio automático / + Automatikgetriebe  
 9) + P disco freno / + frein à disque essieu AR / + ET-disco de freno / + HA-Scheibenbremse  
 10) per cerchione a 4 fori / pour jante à 4 trous / para Llantas de 4 taladros / für 4-Loch-Felge



**OPEL ASTRA G / Vauxhall Astra MKIV (98-04)**

	1.6 16V Convertible	03.01	12.04	G2124152	for 4 bore wheel rim <sup>1)</sup>	256 23,8 21,0 V L +S +C			
	1.7 CDTI	04.03	12.04						
	1.7 DTI	02.00	12.04						
	1.7 TD	04.98	08.00						
	1.8 16V	04.98	12.04				- ABS		
	1.8 16V Caravan	04.98	12.04				- ABS		
	1.8 16V Convertible	03.01	12.04				- ABS		
	2.0 DI	04.98	12.04				- ABS		
	1.6	04.98	12.04				G2125131	for 5 bore wheel rim <sup>2)</sup>	280 24,8 22,0 V L +S +C
	1.6 16V	04.98	12.04						
1.6 CNG	03.03	07.04							
1.8 16V	04.98	12.04	+ ABS						
1.8 16V Caravan	04.98	12.04	+ ABS						
1.8 16V Convertible	03.01	12.04	+ ABS						
1.8 16V Coupe	03.00	12.04							
2.0 16V	04.98	12.04							
2.0 DI	04.98	12.04	+ ABS						
2.0 DTI 16V	08.99	12.04							
2.2 16V	09.00	12.04							
2.2 16V Convertible	03.01	12.04							
2.2 16V Coupe	09.00	12.04							
2.2 DTI 16V	09.02	12.04							
2.2 DTI 16V Convert.	09.02	12.04							
2.2 DTI 16V Coupe	09.02	12.04							
2.0 16V OPC	10.99	12.04	G2125142		308 25,0 23,0 V L +S +C				
2.0 16V OPC Convert.	03.02	12.04							
2.0 Turbo	03.00	12.04							
	1.2 16V	04.98	12.04	G1020554 G1020610		23258 16,5 +/M/Acc/S 23417 15,3 +/M/Acc/S	BOS LUC		
	1.4 16V	04.98	12.04						
	1.6	04.98	12.04						
	1.6 16V	04.98	12.04						
	1.6 16V Caravan	04.98	12.04						
	1.6 16V Convertible	03.01	12.04						
	1.6 CNG	03.03	07.04						
	1.7 CDTI	04.03	12.04						
	1.7 DTI	02.00	12.04						
	1.7 TD	04.98	08.00						
	1.8 16V	04.98	12.04						
	1.8 16V Convertible	03.01	12.04						
	1.8 16V Coupe	03.00	12.04						
	2.0 16V	04.98	12.04						
	2.0 16V OPC	10.99	12.04						
	2.0 16V OPC Convert.	03.02	12.04						
	2.0 DI	04.98	12.04						
	2.0 DTI 16V	08.99	12.04						
	2.0 Turbo	03.00	12.04						
	2.2 16V	09.00	12.04						
	2.2 16V Convertible	03.01	12.04						
	2.2 16V Coupe	09.00	12.04						
	2.2 DTI 16V	09.02	12.04						
	2.2 DTI 16V Convert.	09.02	12.04						
	2.2 DTI 16V Coupe	09.02	12.04						
		1.2 16V	04.98					12.04	G2110251
1.4 16V		04.98	12.04						
1.6		04.98	12.04						
1.6 16V		04.98	12.04						
1.6 16V Convertible		03.01	12.04						
1.7 CDTI		04.03	12.04						
1.7 DTI		02.00	12.04						
1.7 TD		04.98	08.00						
1.8 16V		04.98	12.04	- ABS					
1.8 16V Caravan		04.98	12.04	- ABS					
1.8 16V Convertible	03.01	12.04	- ABS						
2.0 DI	04.98	12.04	- ABS						
	1.6 16V	04.98	12.04	G2110250	for 5 bore wheel rim <sup>2)</sup>	264 9,8 8,0 +S +C			
	1.6 CNG	03.03	07.04						
	1.8 16V	04.98	12.04				+ ABS		
	1.8 16V Caravan	04.98	12.04				+ ABS		
	1.8 16V Convertible	03.01	12.04				+ ABS		
	1.8 16V Coupe	03.00	12.04						
	2.0 16V	04.98	12.04						
	2.0 16V OPC	10.99	12.04						
	2.0 16V OPC Convert.	03.02	12.04						
	2.0 DI	04.98	12.04				+ ABS		
	2.0 DTI 16V	08.99	12.04						
	2.0 Turbo	03.00	12.04						
	2.2 16V	09.00	12.04						
	2.2 16V Convertible	03.01	12.04						
	2.2 16V Coupe	09.00	12.04						
	2.2 DTI 16V	09.02	12.04						
	2.2 DTI 16V Convert.	09.02	12.04						
	2.2 DTI 16V Coupe	09.02	12.04						

<sup>1)</sup> per cerchione a 4 fori / pour jante à 4 trous / para Llantas de 4 taladros / für 4-Loch-Felge

<sup>2)</sup> per cerchione a 5 fori / pour jante à 5 trous / para Llantas de 5 taladros / für 5-Loch-Felge



**OPEL ASTRA H / GTC / Vauxhall Astra Mk V (04-10)**

	1.2		08.05	11.10	G1020765		23832 20,2 +/Wl	ATE
	1.3 CDTI	66	08.05	11.10				
	1.4		01.04	11.10				
	1.6	77	01.04	11.10				
	1.6	85	01.07	11.10				
	1.6 Turbo	132	01.07	11.10				
	1.7 CDTI	59	01.04	11.10				
	1.7 CDTI	74	01.04	11.10				
	1.7 CDTI	81	04.07	11.10				
	1.7 CDTI	92	04.07	11.10				
	1.8	92	01.04	11.10				
	1.8	103	01.06	11.10				
	1.9 CDTI	74	09.05	11.10				
	1.9 CDTI	88	09.04	11.10				
	1.9 CDTI	110	09.04	11.10				
	2.0 Turbo	125	01.04	11.10				
	2.0 Turbo	147	09.04	11.10				
2.0 Turbo OPC	177	03.05	11.10	G1020836 G1020650	for br.caliper +steel piston <sup>1)</sup> for br.caliper +plastic piston <sup>2)</sup>	23738 20,1 +/WD 23402 20,1 +/WD	ATE ATE	
	1.2		08.05	11.10	G2125198	for 4 bore wheel rim <sup>3)</sup>	280 25,0 22,0 V L +S +C	
	1.3 CDTI	66	08.05	11.10				
	1.4		01.04	11.10				
	1.6	77	01.04	11.10				
	1.6	85	01.07	11.10				
	1.6 Turbo	132	01.07	11.10				
	1.7 CDTI	59	01.04	11.10				
	1.7 CDTI	74	01.04	11.10				
	1.7 CDTI	81	04.07	11.10				
	1.7 CDTI	92	04.07	11.10				
	1.8	92	01.04	11.10				
	1.8	103	01.06	11.10				
	1.9 CDTI	74	09.05	11.10				
	1.9 CDTI	88	09.04	11.10				
	1.9 CDTI	110	09.04	11.10				
	2.0 Turbo	125	01.04	11.10				
	2.0 Turbo	147	09.04	11.10				
1.2		08.05	11.10	G2125131	for 5 bore wheel rim <sup>4)</sup>	280 24,8 22,0 V L +S +C		
1.3 CDTI	66	08.05	11.10					
1.4		01.04	11.10					
1.6	77	01.04	11.10					
1.6	85	01.07	11.10					
1.7 CDTI	59	01.04	11.10					
1.7 CDTI	74	01.04	11.10					
1.7 CDTI	81	04.07	11.10					
1.8	92	01.04	11.10					
1.8	103	01.06	11.10					
1.6 Turbo	132	01.07	11.10					
1.7 CDTI	92	04.07	11.10					
1.9 CDTI	74	09.05	11.10					
1.9 CDTI	88	09.04	11.10					
1.9 CDTI	110	09.04	11.10					
2.0 Turbo	125	01.04	11.10					
2.0 Turbo	147	09.04	11.10					
1.2		08.05	11.10	G2125142	for 5 bore wheel rim <sup>4)</sup>	308 25,0 23,0 V L +S +C		
1.3 CDTI	66	08.05	11.10					
1.4		01.04	11.10					
1.6	77	01.04	11.10					
1.6	85	01.07	11.10					
1.7 CDTI	59	01.04	11.10					
1.7 CDTI	74	01.04	11.10					
1.7 CDTI	81	04.07	11.10					
1.8	92	01.04	11.10					
1.8	103	01.06	11.10					
1.6 Turbo	132	01.07	11.10					
1.7 CDTI	92	04.07	11.10					
1.9 CDTI	74	09.05	11.10					
1.9 CDTI	88	09.04	11.10					
1.9 CDTI	110	09.04	11.10					
2.0 Turbo	125	01.04	11.10					
2.0 Turbo	147	09.04	11.10					
1.2		08.05	11.10	G1020610		23417 15,3 +/Wl/Acc/S	LUC	
1.3 CDTI	66	08.05	11.10					
1.4		01.04	11.10					
1.6	77	01.04	11.10					
1.6	85	01.07	11.10					
1.6 Turbo	132	01.07	11.10					
1.7 CDTI	59	01.04	11.10					
1.7 CDTI	74	01.04	11.10					
1.7 CDTI	81	04.07	11.10					
1.7 CDTI	92	04.07	11.10					
1.8	92	01.04	11.10					
1.8	103	01.06	11.10					
1.9 CDTI	74	09.05	11.10					
1.9 CDTI	88	09.04	11.10					
1.9 CDTI	110	09.04	11.10					
2.0 Turbo	125	01.04	11.10					
2.0 Turbo	147	09.04	11.10					
2.0 Turbo OPC	177	03.05	11.10					
	1.2		08.05	11.10	G2110251 G2110250	for 4 bore wheel rim <sup>3)</sup> for 5 bore wheel rim <sup>4)</sup>	240 9,8 8,0 +S +C 264 9,8 8,0 +S +C	
	1.3 CDTI	66	08.05	11.10				
	1.4		01.04	11.10				
	1.6	77	01.04	11.10				
	1.6	85	01.07	11.10				
	1.6 Turbo	132	01.07	11.10				
	1.7 CDTI	59	01.04	11.10				
	1.7 CDTI	74	01.04	11.10				
	1.7 CDTI	81	04.07	11.10				
	1.7 CDTI	92	04.07	11.10				
	1.8	92	01.04	11.10				
	1.8	103	01.06	11.10				
	1.9 CDTI	74	09.05	11.10				
	1.9 CDTI	88	09.04	11.10				
	1.9 CDTI	110	09.04	11.10				
	2.0 Turbo	125	01.04	11.10				

<sup>1)</sup> per pinza fr. +pistone acciaio / pour étrier f. +piston en acier / para pinza fr. +pistón de acero / f. Bremssattel m.Stahlkolben  
<sup>2)</sup> per pinza fr. +pistone plastica / pour étrier fr. +piston plastique / para pinza fr. + piston plástico / f. Bremssattel m.Kunststoffkolben  
<sup>3)</sup> per cerchione a 4 fori / pour jante à 4 trous / para Liantas de 4 taladros / für 4-Loch-Felge  
<sup>4)</sup> per cerchione a 5 fori / pour jante à 5 trous / para Liantas de 5 taladros / für 5-Loch-Felge





**OPEL ASTRA H / GTC / Vauxhall Astra Mk V (04-10)**

	2.0 Turbo	147		09.04	11.10		G2110251 G2110250	for 4 bore wheel rim <sup>1)</sup> for 5 bore wheel rim <sup>2)</sup>	240 9,8 8,0 +S +C 264 9,8 8,0 +S +C
--	-----------	-----	--	-------	-------	--	----------------------	--	--

**OPEL ASTRA H Caravan/Vau. Astra MKV Estate (04-10)**

	1.2	59		08.05	11.10		G1020765		23832 20,2 +/WI	ATE				
	1.3 CDTI	66		08.05	11.10									
	1.4			08.04	11.10									
	1.6	77		08.04	11.10									
	1.6	85		01.07	11.10									
	1.6 LPG	85		08.09	11.10									
	1.6 Turbo	132		01.07	11.10									
	1.7 CDTI	59		08.04	11.10									
	1.7 CDTI	74		08.04	11.10									
	1.7 CDTI	81		04.07	11.10									
	1.7 CDTI	92		04.07	11.10									
	1.7 TD	79		08.04	11.10									
	1.8	92		09.04	11.10									
	1.8	103		08.05	11.10									
	1.9 CDTI	74		09.05	11.10									
	1.9 CDTI	88		08.04	11.10									
	1.9 CDTI	110		09.04	11.10									
2.0 Turbo	125		08.04	11.10										
2.0 Turbo	147		09.04	11.10										
	1.2	59		08.05	11.10		G2125198	for 4 bore wheel rim <sup>1)</sup>	280 25,0 22,0 V L +S +C					
	1.3 CDTI	66		08.05	11.10									
	1.4			08.04	11.10									
	1.6	77		08.04	11.10									
	1.6	85		01.07	11.10									
	1.6 LPG	85		08.09	11.10									
	1.6 Turbo	132		01.07	11.10									
	1.7 CDTI	59		08.04	11.10									
	1.7 CDTI	74		08.04	11.10									
	1.7 CDTI	81		04.07	11.10									
	1.7 CDTI	92		04.07	11.10									
	1.7 TD	79		08.04	11.10									
	1.8	92		09.04	11.10									
	1.8	103		08.05	11.10									
	1.9 CDTI	74		09.05	11.10									
	1.9 CDTI	88		08.04	11.10									
	1.9 CDTI	110		09.04	11.10									
2.0 Turbo	125		08.04	11.10										
2.0 Turbo	147		09.04	11.10										
	1.8	92		09.04	11.10		G2125131	for 5 bore wheel rim <sup>2)</sup>	280 24,8 22,0 V L +S +C					
	1.2	59		08.05	11.10									
	1.3 CDTI	66		08.05	11.10									
	1.4			08.04	11.10									
	1.6	77		08.04	11.10									
	1.6	85		01.07	11.10									
	1.6 LPG	85		08.09	11.10									
	1.7 CDTI	59		08.04	11.10									
	1.7 CDTI	74		08.04	11.10									
	1.7 CDTI	81		04.07	11.10									
	1.7 CDTI	92		04.07	11.10									
	1.7 TD	79		08.04	11.10									
	1.8	92		09.04	11.10									
	1.8	103		08.05	11.10									
	1.9 CDTI	74		09.05	11.10									
	1.9 CDTI	88		08.04	11.10									
	1.9 CDTI	110		09.04	11.10									
2.0 Turbo	125		08.04	11.10										
2.0 Turbo	147		09.04	11.10										
	1.6 Turbo	132		01.07	11.10		G2125142	for 5 bore wheel rim <sup>2)</sup>	308 25,0 23,0 V L +S +C					
	1.7 CDTI	92		04.07	11.10									
	1.9 CDTI	74		09.05	11.10									
	1.9 CDTI	88		08.04	11.10									
	1.9 CDTI	110		09.04	11.10									
	2.0 Turbo	125		08.04	11.10									
	2.0 Turbo	147		09.04	11.10									
		1.2	59		08.05	11.10					G1020610		23417 15,3 +/WI/Acc/S	LUC
		1.3 CDTI	66		08.05	11.10								
		1.4			08.04	11.10								
		1.6	77		08.04	11.10								
		1.6	85		01.07	11.10								
		1.6 LPG	85		08.09	11.10								
		1.6 Turbo	132		01.07	11.10								
		1.7 CDTI	59		08.04	11.10								
		1.7 CDTI	74		08.04	11.10								
		1.7 CDTI	81		04.07	11.10								
1.7 CDTI		92		04.07	11.10									
1.7 TD		79		08.04	11.10									
1.8		92		09.04	11.10									
1.8		103		08.05	11.10									
1.9 CDTI		74		09.05	11.10									
1.9 CDTI		88		08.04	11.10									
1.9 CDTI		110		09.04	11.10									
2.0 Turbo	125		08.04	11.10										
2.0 Turbo	147		09.04	11.10										
	1.2	59		08.05	11.10		G2110251 G2110250	for 4 bore wheel rim <sup>1)</sup> for 5 bore wheel rim <sup>2)</sup>	240 9,8 8,0 +S +C 264 9,8 8,0 +S +C					
	1.3 CDTI	66		08.05	11.10									
	1.4			08.04	11.10									
	1.6	77		08.04	11.10									
	1.6	85		01.07	11.10									

<sup>1)</sup> per cerchione a 4 fori / pour jante à 4 trous / para Llantas de 4 taladros / für 4-Loch-Felge  
<sup>2)</sup> per cerchione a 5 fori / pour jante à 5 trous / para Llantas de 5 taladros / für 5-Loch-Felge



### OPEL ASTRA H Caravan/Vau. Astra MKV Estate (04-10)

	1.6 LPG	85		08.09	11.10	G2110251 G2110250	for 4 bore wheel rim <sup>1)</sup> for 5 bore wheel rim <sup>2)</sup>	240 9,8 8,0 +S +C 264 9,8 8,0 +S +C
	1.6 Turbo	132		01.07	11.10			
	1.7 CDTI	59		08.04	11.10			
	1.7 CDTI	74		08.04	11.10			
	1.7 CDTI	81		04.07	11.10			
	1.7 CDTI	92		04.07	11.10			
	1.7 TD	79		08.04	11.10			
	1.8	92		09.04	11.10			
	1.8	103		08.05	11.10			
	1.9 CDTI	74		09.05	11.10			
	1.9 CDTI	88		08.04	11.10			
	1.9 CDTI	110		09.04	11.10			
	2.0 Turbo	125		08.04	11.10			
	2.0 Turbo	147		09.04	11.10			

### OPEL ASTRA H TwinTop (06-10)

	1.6	77		03.06	11.10	G1020765		23832 20,2 +/W/	ATE
	1.6	85		12.06	11.10				
	1.6 Turbo	132		02.07	11.10				
	1.8			03.06	11.10				
	1.9 CDTI	110		03.06	11.10				
	2.0 Turbo	125		03.06	11.10				
	2.0 Turbo	147		03.06	11.10				
	1.6	77		03.06	11.10	G2125198	for 4 bore wheel rim <sup>1)</sup>	280 25,0 22,0 V L +S +C	
	1.6	85		12.06	11.10				
	1.6 Turbo	132		02.07	11.10				
	1.8			03.06	11.10				
	1.9 CDTI	110		03.06	11.10				
	2.0 Turbo	125		03.06	11.10				
	2.0 Turbo	147		03.06	11.10				
	1.6	77		03.06	11.10	G2125131	for 5 bore wheel rim <sup>2)</sup>	280 24,8 22,0 V L +S +C	
	1.6	85		12.06	11.10				
	1.8			03.06	11.10				
	1.6 Turbo	132		02.07	11.10	G2125142	for 5 bore wheel rim <sup>2)</sup>	308 25,0 23,0 V L +S +C	
	1.9 CDTI	110		03.06	11.10				
	2.0 Turbo	125		03.06	11.10				
	2.0 Turbo	147		03.06	11.10				
	1.6	77		03.06	11.10	G1020610		23417 15,3 +/W/Acc/S	LUC
	1.6	85		12.06	11.10				
	1.6 Turbo	132		02.07	11.10				
	1.8			03.06	11.10				
	1.9 CDTI	110		03.06	11.10				
	2.0 Turbo	125		03.06	11.10				
	2.0 Turbo	147		03.06	11.10				
	1.6	77		03.06	11.10	G2110250	for 5 bore wheel rim <sup>2)</sup>	264 9,8 8,0 +S +C	
	1.6	85		12.06	11.10				
	1.6 Turbo	132		02.07	11.10				
	1.8			03.06	11.10				
	1.9 CDTI	110		03.06	11.10				
	2.0 Turbo	125		03.06	11.10				
	2.0 Turbo	147		03.06	11.10				

### OPEL ASTRA J / GTC / Vauxhall Astra MK VI (09-)

	1.3 CDTI ECOTEC	70		12.09		G1020928	+ 16" wheel <sup>3)</sup>	24034 19,1 +/W/Acc	
	1.4 ecoFLEX	64		12.09					
	1.4 ecoFLEX	74		12.09					
	1.4 LPG Turbo ecoFLEX	103		01.12					
	1.4 Turbo ECOTEC	88		11.10					
	1.4 Turbo ECOTEC	103		12.09					
	1.6 SIDI	125		12.12					
	1.6 Turbo ECOTEC	85		12.09					
	1.6 Turbo ECOTEC	132		12.09					
	1.7 CDTI ECOTEC	81		12.09					
	1.7 CDTI ECOTEC	96		12.09					
	2.0 CDTI BiTurbo	143		12.12					
	2.0 CDTI ECOTEC			12.09					
	1.3 CDTI ECOTEC	70		12.09		G1201145	+ 17" wheel <sup>4)</sup>	24412 19,0 +/W/Acc	MAN
	1.4 ecoFLEX	64		12.09					
	1.4 ecoFLEX	74		12.09					
	1.4 LPG Turbo ecoFLEX	103		01.12					
	1.4 Turbo ECOTEC	88		11.10					
	1.4 Turbo ECOTEC	103		12.09					
	1.6 SIDI	125		12.12					
	1.6 Turbo ECOTEC	85		12.09					
	1.6 Turbo ECOTEC	132		12.09					
	1.7 CDTI ECOTEC	81		12.09					
	1.7 CDTI ECOTEC	96		12.09					
	2.0 CDTI BiTurbo	143		12.12					
	2.0 CDTI ECOTEC			12.09					
	1.3 CDTI ECOTEC	70		12.09		G1020953		25096 17,0 +/W/Acc	ATE
	1.4 ecoFLEX	64		12.09					
	1.4 ecoFLEX	74		12.09					
	1.4 LPG Turbo ecoFLEX	103		01.12					
	1.4 Turbo ECOTEC	88		11.10					
	1.4 Turbo ECOTEC	103		12.09					
	1.6 SIDI	125		12.12					

<sup>1)</sup> per cerchione a 4 fori / pour jante à 4 trous / para Llantas de 4 taladros / für 4-Loch-Felge  
<sup>2)</sup> per cerchione a 5 fori / pour jante à 5 trous / para Llantas de 5 taladros / für 5-Loch-Felge  
<sup>3)</sup> + ruota 16" / + roue 16" / + rueda 16" / + 16" Rad  
<sup>4)</sup> + ruota 17" / + roue 17" / + rueda 17" / + 17" Rad

























OPEL ASTRA J / GTC / Vauxhall Astra MK VI (09-)										
	1.6 Turbo ECOTEC	85		12.09		G1020953			25096 17,0 +/W/Acc	ATE
	1.6 Turbo ECOTEC	132		12.09						
	1.7 CDTi ECOTEC	81		12.09						
	1.7 CDTi ECOTEC	96		12.09						
	1.8	103		10.11						
	2.0 CDTi BiTurbo	143		12.12						
	2.0 CDTi ECOTEC			12.09						
OPEL ASTRA J Sports Tourer/Vau.Astra Sports Tourer (10-)										
	1.3 CDTi ECOTEC	70		11.10		G1020928		+ 16" wheel <sup>1)</sup>	24034 19,1 +/W/Acc	
	1.4 ecoFLEX	64		11.10						
	1.4 ecoFLEX	74		11.10						
	1.4 LPG Turbo ecoFLEX	103		01.12						
	1.4 Turbo ECOTEC	88		11.10						
	1.4 Turbo ECOTEC	103		11.10						
	1.6 ECOTEC	85		11.10						
	1.6 LPG	84		10.12						
	1.6 SIDI	125		12.12						
	1.6 Turbo ECOTEC	132		11.10						
	1.7 CDTi ECOTEC			11.10						
	1.7 CDTi ECOTEC	92		11.10						
	2.0 CDTi BiTurbo	143		12.12						
	2.0 CDTi ECOTEC			11.10						
	1.3 CDTi ECOTEC	70		11.10		G1201145		+ 17" wheel <sup>2)</sup>	24412 19,0 +/W/Acc	MAN
	1.4 ecoFLEX	64		11.10						
	1.4 ecoFLEX	74		11.10						
	1.4 LPG Turbo ecoFLEX	103		01.12						
	1.4 Turbo ECOTEC	88		11.10						
	1.4 Turbo ECOTEC	103		11.10						
	1.6 ECOTEC	85		11.10						
	1.6 LPG	84		10.12						
	1.6 SIDI	125		12.12						
	1.6 Turbo ECOTEC	132		11.10						
	1.7 CDTi ECOTEC			11.10						
	1.7 CDTi ECOTEC	92		11.10						
	2.0 CDTi BiTurbo	143		12.12						
	2.0 CDTi ECOTEC			11.10						
	1.3 CDTi ECOTEC	70		11.10		G1020953			25096 17,0 +/W/Acc	ATE
	1.4 ecoFLEX	64		11.10						
	1.4 ecoFLEX	74		11.10						
	1.4 LPG Turbo ecoFLEX	103		01.12						
	1.4 Turbo ECOTEC	88		11.10						
	1.4 Turbo ECOTEC	103		11.10						
	1.6 ECOTEC	85		11.10						
	1.6 LPG	84		10.12						
	1.6 SIDI	125		12.12						
	1.6 Turbo ECOTEC	132		11.10						
	1.7 CDTi ECOTEC			11.10						
	1.7 CDTi ECOTEC	92		11.10						
	2.0 CDTi BiTurbo	143		12.12						
	2.0 CDTi ECOTEC			11.10						
OPEL CALIBRA / Vauxhall Calibra (89-97)										
	2.0			09.89	07.97	G1020258			21190 17,5 +/WD	ATE
	2.0 16V			09.89	07.97					
	2.0 16V 4x4			09.89	07.97					
	2.0 4x4			09.89	07.97					
	2.0 Turbo		S9999999	03.92		G1020369			21411 17,5 +	ATE
	2.5		S9999999	02.93						
	2.0 Turbo	T1000001		07.97		G1020403			21829 20,3 +/WD	ATE
	2.5	T1000001		07.97						
	2.0			09.89	07.97	G2124115			256 24,0 21,0 V L +S +C	
	2.0 16V			09.89	07.97					
	2.0 16V 4x4			09.89	07.97					
	2.0 4x4			09.89	07.97					
	2.0 Turbo	T1000001		07.97		G2125119			288 25,0 22,0 V L +S +C	
	2.5	T1000001		07.97						
	2.0			09.89	07.97	G1020272			21140 15,0	ATE
	2.0 16V			09.89	07.97					
	2.0 16V 4x4			09.89	07.97					
	2.0 4x4			09.89	07.97					
	2.0 Turbo		S9999999	03.92	07.97					
	2.5		S9999999	02.93						
	2.5	T1000001		07.97		G1020271			21050 15,0	ATE
OPEL CASCADA / Vauxhall Cascada (13-)										
	1.4 Turbo ECOTEC	88		01.13		G1201145			24412 19,0 +/W/Acc	MAN
	1.4 Turbo ECOTEC	103		01.13						
	1.6 SIDI Turbo	125		01.13						
	2.0 CDTi BiTurbo	143		01.13						
	2.0 CDTi ECOTEC	121		01.13						
	1.4 Turbo ECOTEC	88		01.13		G1020953			25096 17,0 +/W/Acc	ATE
	1.4 Turbo ECOTEC	103		01.13						
	1.6 SIDI Turbo	125		01.13						
	2.0 CDTi BiTurbo	143		01.13						
	2.0 CDTi ECOTEC	121		01.13						

<sup>1)</sup> + ruota 16" / + roue 16" / + rueda 16" / + 16" Rad

<sup>2)</sup> + ruota 17" / + roue 17" / + rueda 17" / + 17" Rad

        											
<b>OPEL COMBO / Vauxhall Combo (01-11)</b>											
	1.3 CDTi		53000000	06.03		G1020545		23225	17,0 +/MI/Acc/S	LUC	
	1.4 16V		53000000	10.01							
	1.6		53000000	10.01							
	1.7 DI 16V		53000000	10.01							
	1.7 DTI 16V		53000000	10.01							
	1.3 CDTi	53000001		10.11		G1020765		23832	20,2 +/MI	ATE	
	1.4 16V	53000001		10.11							
	1.6	53000001		10.11							
	1.6 CNG			04.05	10.11						
	1.7 CDTi 16V			06.04	10.11						
	1.7 DI 16V	53000001			10.11						
	1.7 DTI 16V	53000001			10.11						
	1.7 DTI 16V				10.11						
	1.3 CDTi		43033898	06.03		G2124166		260	24,0 21,0 V L +C		
	1.4 16V		43033898	10.01							
	1.6		43033898	10.01							
	1.7 DI 16V		43033898	10.01							
	1.7 DTI 16V		43033898	10.01							
	1.3 CDTi	43033899		10.11		G2125148		280	25,0 22,0 V L +S +C		
	1.4 16V	43033899		10.11							
	1.6	43033899		10.11							
	1.6 CNG			04.05	10.11						
	1.7 DI 16V	43033899			10.11						
1.7 DTI 16V	43033899			10.11							
1.7 CDTi 16V			06.04	10.11		G2125131		280	24,8 22,0 V L +S +C		
	1.3 CDTi			06.03	10.11	G1020610		23417	15,3 +/MI/Acc/S	LUC	
	1.4 16V			10.01	10.11						
	1.6			10.01	10.11						
	1.6 CNG			04.05	10.11						
	1.7 CDTi 16V			06.04	10.11						
	1.7 DI 16V			10.01	10.11						
	1.7 DTI 16V			10.01	10.11						
	1.7 DTI 16V			10.01	10.11						
	1.7 CDTi 16V			06.04	10.11	G2110250		264	9,8 8,0 +S +C		
<b>OPEL COMBO D / Vauxhall Combo D (11-)</b>											
	1.3 CDTi	66		11.11		G2122145	+ 15" wheel 1)	284	22,0 20,2 V +C		
	1.4	70		11.11							
	1.4 CNG	88		11.11							
	1.6 CDTi	66		11.11							
	1.6 CDTi	74		11.11							
	1.6 CDTi	77		11.11							
	2.0 CDTi	99		11.11							
<b>OPEL CORSA B / Vauxhall Corsa (93-00)</b>											
	1.0 12V			11.96	09.00	G1020317		20547	16,5 +/WD	ATE	
	1.2			03.93	09.00						
	1.2 16V			04.98	09.00						
	1.4			03.93	09.00						
	1.4 i 16V			03.93	09.00						
	1.4 Si	60		03.93	09.00						
	1.5 D			03.93	09.00						
	1.5 TD			03.93	09.00						
	1.6 GSi 16V	109		09.93	09.00						
	1.6 i 16V			09.93	09.00						
	1.7 D			09.93	09.00						
	Combo			09.93	09.00						
	1.0 12V			11.96	09.00	G2113161		236	12,7 9,7 +S +C		
	1.2			03.93	09.00						
	1.2 16V			04.98	09.00						
	1.2 16V			04.98	09.00						
	1.4			03.93	09.00						
	1.4			03.93	09.00						
	1.5 D			03.93	09.00						
	1.5 TD			03.93	09.00						
	1.7 D			09.93	09.00						
	1.2 16V			04.98	09.00						
	1.2 16V			04.98	09.00						
	1.4			03.93	09.00						
	1.4			03.93	09.00						
	1.4 i 16V			09.93	09.00						
1.4 Si	60		03.93	09.00							
Combo			09.93	09.00							
1.6 GSi 16V	109		09.93	09.00							
1.6 i 16V			09.93	09.00							
<b>OPEL CORSA C / Vauxhall Corsa MK II (00-06)</b>											
	1.0 12V			09.00	09.06	G1020545		23225	17,0 +/MI/Acc/S	LUC	
	1.2 16V			09.00	09.06						
	1.3 CDTi			06.03	09.06						
	1.4 16V			09.00	09.06						
	1.6			09.01	09.06						
	1.7 DI 16V			09.00	09.06						
	1.7 DTI 16V			09.00	09.06						
	1.8 16V			09.00	09.06						
	1.7 CDTi			06.03	09.06						

1) + ruota 15" / + roue 15" / + rueda 15" / + 15" Rad

2) - Sport/+ scatola.auto./- aria condiz. / - Sport/+ transm.auto./- air condit. / - Sport/+ cambio auto./- aire acond. / - Sport/+ Automatikgetr./ - Klimaanlage

3) - Sport/ + cambio velocità / - Sport/ + transm. mécanique / - Sport/ + cambio velocidad / - Sport/ + Schaltgetriebe

4) + Sportivo / + Sport / + Deportivo / + Sport

5) - Sport/+ scatola.auto./+ aria condiz. / - Sport/+ transm.auto./+ air condit. / - Sport/+ cambio auto./+ aire acond. / - Sport/ + Automatikgetr./ + Klimaanlage



### OPEL CORSA C / Vauxhall Corsa MK II (00-06)

	1.0 12V			09.00	09.06	- ABS	G2111152		240 11,0 8,0 +C
	1.2 16V			09.00	09.06	- ABS			
	1.0 12V			09.00	09.06	+ ABS	G2120174		240 20,0 17,0 V +C
	1.2 16V			09.00	09.06	+ ABS			
	1.7 DI 16V			09.00	09.06				
	1.3 CDTi			06.03	09.06		G2124166		260 24,0 21,0 V L +C
	1.4 16V			09.00	09.06				
1.6			09.01	09.06					
1.7 DTi 16V			09.00	09.06					
1.8 16V			09.00	09.06					
1.7 CDTi			06.03	09.06		G2125131		280 24,8 22,0 V L +S +C	
	1.4 16V			09.00	09.06		G1020560		23284 14,0 /M/S LUC
	1.8 16V			09.00	09.06				

### OPEL CORSA D / Vauxhall Corsa MK III (06-)

	1.0 i			10.06		+ ventilated discs <sup>1)</sup>	G1020858		24288 18,0 +/M/Acc/S BOS
	1.2	51		06.10					
	1.2	63		06.10			G1020833		23981 19,0 +/M/Acc/S BOS
	1.2 16V	59		10.06					
	1.2 LPG			09.09					
	1.3 CDTi	55		10.06		+ brake disc 257mm <sup>2)</sup>			
	1.3 CDTi	70		06.10		+ brake disc 257mm <sup>2)</sup>			
	1.4	64		09.09					
	1.4	74		06.10					
	1.4 i 16V	66		10.06					
1.3 CDTi	55		10.06		+ brake disc 284mm <sup>3)</sup>				
1.3 CDTi	66		10.06						
1.3 CDTi	70		06.10		+ brake disc 284mm <sup>3)</sup>	G1020765		23832 20,2 +/M/Ate ATE	
1.6 Turbo GSI	110		06.07						
1.6 Turbo OPC			03.07						
	1.0 i			10.06			G2112184		257 12,0 10,0 +S +C
	1.0 i			10.06					
	1.2	51		06.10			G2122231		257 22,0 20,0 V +S +C
	1.2	63		06.10					
	1.2 16V	59		10.06					
	1.2 LPG			09.09					
	1.3 CDTi	55		10.06		+ brake disc 257mm <sup>2)</sup>			
	1.3 CDTi	70		06.10		+ brake disc 257mm <sup>2)</sup>			
	1.4	64		09.09					
	1.4	74		06.10					
1.4 i 16V	66		10.06						
1.6 Turbo GSI	110		06.07			G2125142			
1.6 Turbo OPC			03.07		- Nürburgring edition <sup>4)</sup>				

### OPEL GT (07-09)

	2.0	194		02.07	07.09		G1020727		23482 16,6 + ATE
--	-----	-----	--	-------	-------	--	----------	--	------------------

### OPEL INSIGNIA / Vauxhall Insignia (08-)

	1.4 Turbo ecoFLEX	103		06.11			G1201143 G1201145 G1201147	+ 16" wheel <sup>5)</sup> + 17" wheel <sup>6)</sup> + 17+" wheel <sup>7)</sup>	24415 19,1 +/M/Acc MAN 24412 19,0 +/M/Acc MAN 24418 17,0 +/M/Acc LUC
	1.4 Turbo LPG ecoFLEX	103		07.12					
	1.6	85		07.08					
	1.6 SIDI	125		03.13			G1201148 G1201149	+ 16" wheel <sup>5)</sup> + 17"/17+" wheel <sup>8)</sup>	24421 17,2 +/M/Acc LUC 24421 17,2 +/M/Acc LUC
	1.6 Turbo	132		10.08					
	1.8	103		07.08					
	2.0 BiTurbo CDTi			07.08					
	2.0 BiTurbo CDTi 4x4			07.08					
	2.0 CDTi	81		07.08					
	2.0 CDTi	88		03.13					
	2.0 CDTi	96		07.08					
	2.0 CDTi	103		07.13					
	2.0 CDTi	118		07.08					
	2.0 CDTi	120		07.13					
	2.0 CDTi 4x4	118		06.10					
	2.0 CDTi 4x4	120		07.13					
	2.0 Turbo	162		07.08					
2.0 Turbo	184		06.11						
2.0 Turbo 4x4	162		07.08						
2.0 Turbo 4x4	184		09.11						
	1.4 Turbo ecoFLEX	103		06.11			G1201148 G1201149	+ 16" wheel <sup>5)</sup> + 17"/17+" wheel <sup>8)</sup>	24421 17,2 +/M/Acc LUC 24421 17,2 +/M/Acc LUC
	1.4 Turbo LPG ecoFLEX	103		07.12					
	1.6	85		07.08					
	1.6 SIDI	125		03.13					
	1.6 Turbo	132		10.08					
	1.8	103		07.08					
	2.0 BiTurbo CDTi			07.08					
	2.0 BiTurbo CDTi 4x4			07.08					
	2.0 CDTi	81		07.08					
	2.0 CDTi	88		03.13					
	2.0 CDTi	96		07.08					
	2.0 CDTi	103		07.13					
	2.0 CDTi	118		07.08					
	2.0 CDTi	120		07.13					

<sup>1)</sup> + dischi ventilati / + disques ventilés / + disco ventilado / + belüftete Scheiben  
<sup>2)</sup> + dischi freno 257mm / + disque de frein 257mm / + disco de freno 257mm / + Brems Scheibe 257mm  
<sup>3)</sup> + dischi freno 284mm / + disque de frein 284mm / + disco de freno 284mm / + Brems Scheibe 284mm  
<sup>4)</sup> - edizione Nürburgring / - édition Nürburgring / - edición Nürburgring / - Nuerburgring Edition  
<sup>5)</sup> + ruota 16" / + roue 16" / + rueda 16" / + 16" Rad  
<sup>6)</sup> + ruota 17" / + roue 17" / + rueda 17" / + 17" Rad  
<sup>7)</sup> + ruota 17+" / + roue 17+" / + rueda 17+" / + 17+" Rad  
<sup>8)</sup> + ruota 17"/17+" / + roue 17"/17+" / + rueda 17"/17+" / + 17"/17+" Rad



















OPEL INSIGNIA / Vauxhall Insignia (08-)									
	2.0 CDTI 4x4	118		06.10		G1201148 G1201149	+ 16" wheel <sup>1)</sup> + 17"/17+" wheel <sup>2)</sup>	24421 17,2 +/W/Acc 24421 17,2 +/W/Acc	LUC LUC
	2.0 CDTI 4x4	120		07.13					
	2.0 Turbo	162		07.08					
	2.0 Turbo	184		06.11					
	2.0 Turbo 4x4	162		07.08					
	2.0 Turbo 4x4	184		09.11					
	2.8 V6 T 4x4 OPC	239		07.09		G1201149	+ 18" wheel <sup>3)</sup>	24421 17,2 +/W/Acc	LUC
	2.8 V6 Turbo 4x4	191		07.08					

OPEL INSIGNIA Sports Tourer / Vauxh. Insignia SportsTourer (08-)									
	1.4 Turbo ecoFLEX	103		06.11		G1201143 G1201145 G1201147	+ 16" wheel <sup>1)</sup> + 17" wheel <sup>4)</sup> + 17+" wheel <sup>5)</sup>	24415 19,1 +/W/Acc 24412 19,0 +/W/Acc 24418 17,0 +/W/Acc	MAN MAN LUC
	1.4 Turbo LPG ecoFLEX	103		07.12					
	1.6	85		07.08					
	1.6 SIDI	125		03.13					
	1.6 Turbo	132		10.08					
	1.8	103		07.08					
	2.0 BiTurbo CDTI			07.08					
	2.0 BiTurbo CDTI 4x4			07.08					
	2.0 CDTI	81		07.08					
	2.0 CDTI	88		03.13					
	2.0 CDTI	96		07.08					
	2.0 CDTi	103		07.13					
	2.0 CDTI	118		07.08					
	2.0 CDTi	120		07.13					
	2.0 CDTI 4x4	118		06.10					
	2.0 CDTI 4x4	120		07.13					
	2.0 Turbo	162		07.08					
	2.0 Turbo	184		06.11					
	2.0 Turbo 4x4	162		07.08					
	2.0 Turbo 4x4	184		09.11					
	1.4 Turbo ecoFLEX	103		06.11		G1201148 G1201149	+ 16" wheel <sup>1)</sup> + 17"/17+" wheel <sup>2)</sup>	24421 17,2 +/W/Acc 24421 17,2 +/W/Acc	LUC LUC
	1.4 Turbo LPG ecoFLEX	103		07.12					
	1.6	85		07.08					
	1.6 SIDI	125		03.13					
	1.6 Turbo	132		10.08					
	1.8	103		07.08					
	2.0 BiTurbo CDTI			07.08					
	2.0 BiTurbo CDTI 4x4			07.08					
	2.0 CDTI	81		07.08					
	2.0 CDTI	88		03.13					
	2.0 CDTI	96		07.08					
	2.0 CDTi	103		07.13					
	2.0 CDTI	118		07.08					
	2.0 CDTi	120		07.13					
	2.0 CDTI 4x4	118		06.10					
	2.0 CDTI 4x4	120		07.13					
	2.0 Turbo	162		07.08					
	2.0 Turbo	184		06.11					
	2.0 Turbo 4x4	162		07.08					
	2.0 Turbo 4x4	184		09.11					
	2.8 V6 T 4x4 OPC	239		07.09		G1201149	+ 18" wheel <sup>3)</sup>	24421 17,2 +/W/Acc	LUC
	2.8 V6 Turbo 4x4	191		07.08					

OPEL MERIVA A / Vauxhall Meriva Mk I (03-10)										
	1.4 16V	66		07.04	05.10	G1020545	+ 4 bore wheel rim <sup>6)</sup>	23225 17,0 +/W/Acc/S	LUC	
	1.4 LPG	66		07.04	05.10					
	1.6	64		05.03	05.10					
		1.3 CDTI	51		04.05	05.10	G1020765		23832 20,2 +/W/Acc	ATE
		1.3 CDTI	55		09.03	05.10				
		1.4 16V	66		07.04	05.10				
		1.4 LPG	66		07.04	05.10				
		1.6	77		01.06	05.10				
		1.6 16V	74		05.03	05.10				
		1.6 Turbo OPC	132		09.05	05.10				
	1.7 CDTI	74		09.03	05.10					
	1.7 CDTI	92		09.06	05.10					
	1.7 DTI 16V	55		09.02	05.10					
	1.8 16V	92		09.02	05.10					
	1.4 16V	66		07.04	05.10	G2124166	for 4 bore wheel rim <sup>8)</sup>	260 24,0 21,0 V L + C		
	1.4 LPG	66		07.04	05.10					
	1.6	64		05.03	05.10					
		1.3 CDTI	51		04.05	05.10	G2125148	for 4 bore wheel rim <sup>8)</sup>	280 25,0 22,0 V L + S + C	
		1.3 CDTI	55		09.03	05.10				
		1.6	77		01.06	05.10				
		1.6 16V	74		05.03	05.10				
		1.7 DTI	48		05.03	05.10				
		1.7 DTI 16V	55		05.03	05.10				
		1.8 16V	92		05.03	05.10				
		1.3 CDTI	51		04.05	05.10	G2125131	for 5 bore wheel rim <sup>9)</sup>	280 24,8 22,0 V L + S + C	
		1.3 CDTI	55		09.03	05.10				
		1.4 16V	66		07.04	05.10				
		1.4 LPG	66		07.04	05.10				
		1.6	64		05.03	05.10				
		1.6	77		01.06	05.10				
		1.6 16V	74		05.03	05.10				
		1.7 CDTI	74		09.03	05.10				
	1.7 CDTI	92		09.03	05.10					

<sup>1)</sup> + ruota 16" / + roue 16" / + rueda 16" / + 16" Rad  
<sup>2)</sup> + ruota 17"/17+" / + roue 17"/17+" / + rueda 17"/17+" / + 17"/17+" Rad  
<sup>3)</sup> + ruota 18" / + roue 18" / + rueda 18" / + 18" Rad  
<sup>4)</sup> + ruota 17" / + roue 17" / + rueda 17" / + 17" Rad  
<sup>5)</sup> + ruota 17+" / + roue 17+" / + rueda 17+" / + 17+" Rad  
<sup>6)</sup> + cerchione a 4 fori / + jante à 4 trous / + Liantas de 4 taladros / + 4-Loch Felge  
<sup>7)</sup> + cerchione a 5 fori / + jante à 5 trous / + Liantas de 5 taladros / + 5-Loch Felge  
<sup>8)</sup> per cerchione a 4 fori / pour jante à 4 trous / para Liantas de 4 taladros / für 4-Loch-Felge  
<sup>9)</sup> per cerchione a 5 fori / pour jante à 5 trous / para Liantas de 5 taladros / für 5-Loch-Felge





















											
<b>OPEL MERIVA A / Vauxhall Meriva Mk I (03-10)</b>											
	1.7 CDTI	92		09.06	05.10	G2125131	for 5 bore wheel rim <sup>1)</sup>	280 24,8 22,0 V L +S +C			
	1.7 DTI	48		05.03	05.10						
	1.7 DTI 16V	55		05.03	05.10						
	1.8 16V	92		05.03	05.10						
	1.6 Turbo OPC	132		09.05	05.10						
	1.3 CDTI	51		04.05	05.10	G1020610		23417 15,3 +/W/Acc/S LUC			
	1.3 CDTI	55		09.03	05.10						
	1.4 16V	66		07.04	05.10						
	1.4 LPG	66		07.04	05.10						
	1.6	64		05.03	05.10						
	1.6	77		01.06	05.10						
	1.6 16V	74		05.03	05.10						
	1.6 Turbo OPC	132		09.05	05.10						
	1.7 CDTI	74		09.03	05.10						
	1.7 CDTI	92		09.06	05.10						
	1.7 DTI	48		05.03	05.10						
	1.7 DTI 16V	55		05.03	05.10						
	1.8 16V	92		05.03	05.10						
		1.4 16V	66		07.04				05.10	G2110251	for 4 bore wheel rim <sup>2)</sup>
1.4 LPG		66		07.04	05.10						
1.6		64		05.03	05.10						
1.3 CDTI		51		04.05	05.10	G2110250	for 5 bore wheel rim <sup>1)</sup>	264 9,8 8,0 +S +C			
1.3 CDTI		55		09.03	05.10						
1.4 16V		66		07.04	05.10						
1.4 LPG		66		07.04	05.10						
1.6		64		05.03	05.10						
1.6		77		01.06	05.10						
1.6 16V		74		05.03	05.10						
1.6 Turbo OPC	132		09.05	05.10							
1.7 CDTI	74		09.03	05.10							
1.7 CDTI	92		09.06	05.10							
1.7 DTI	48		05.03	05.10							
1.7 DTI 16V	55		05.03	05.10							
1.8 16V	92		05.03	05.10							
<b>OPEL MERIVA B / Vauxhall Meriva Mk II (10-)</b>											
	1.3 CDTI	55		06.10		G1020765		23832 20,2 +/W/ ATE			
	1.3 CDTI	70		06.10							
	1.4	74		06.10							
	1.4	103		06.10							
	1.4 ecoFLEX	88		06.10							
	1.7 CDTi	74		06.10							
	1.7 CDTi	81		06.10							
1.7 CDTi	96		06.10								
	1.3 CDTI	55		06.10		G2125131		280 24,8 22,0 V L +S +C			
	1.3 CDTI	70		06.10							
	1.4	74		06.10							
	1.4 ecoFLEX	88		06.10							
	1.7 CDTi	74		06.10							
	1.7 CDTi	81		06.10							
	1.7 CDTi	96		06.10							
	1.4	103		06.10					G2125142		308 25,0 23,0 V L +S +C
	1.7 CDTi	74		06.10							
	1.7 CDTi	81		06.10							
1.7 CDTi	96		06.10								
	1.3 CDTI	55		06.10		G1020610		23417 15,3 +/W/Acc/S LUC			
	1.3 CDTI	70		06.10							
	1.4	74		06.10							
	1.4	103		06.10							
	1.4 ecoFLEX	88		06.10							
	1.7 CDTi	74		06.10							
	1.7 CDTi	81		06.10							
1.7 CDTi	96		06.10								
	1.3 CDTI	55		06.10		G2110250		264 9,8 8,0 +S +C			
	1.3 CDTI	70		06.10							
	1.4	74		06.10							
	1.4	103		06.10							
	1.4 ecoFLEX	88		06.10							
	1.7 CDTi	74		06.10							
	1.7 CDTi	81		06.10							
1.7 CDTi	96		06.10								
<b>OPEL MOVANO A (98-10)</b>											
	1.9 DTI			09.00	01.10 + 16" wheel <sup>3)</sup>	G1020624		23613 17,7 BOS			
	2.2 DTI 16V	66		09.00	01.10 + 16" wheel <sup>3)</sup>						
	2.5 CDTI	74		09.06	01.10 + 16" wheel <sup>3)</sup>						
	2.5 CDTI	88		09.06	01.10 + 16" wheel <sup>3)</sup>						
	2.5 CDTI	107		09.06	01.10 + 16" wheel <sup>3)</sup>						
	2.5 D	59		07.98	09.00 + 16" wheel <sup>3)</sup>						
	2.5 DTI			10.01	01.10 + 16" wheel <sup>3)</sup>						
	2.8 DTI			07.98	10.01 + 16" wheel <sup>3)</sup>						
	3.0 DTI	100		10.03	01.10 + 16" wheel <sup>3)</sup>						

<sup>1)</sup> per cerchione a 5 fori / pour jante à 5 trous / para Llantas de 5 taladros / für 5-Loch-Felge

<sup>2)</sup> per cerchione a 4 fori / pour jante à 4 trous / para Llantas de 4 taladros / für 4-Loch-Felge

<sup>3)</sup> + ruota 16" / + roue 16" / + rueda 16" / + 16" Rad

								
<b>OPEL MOVANO A (98-10)</b>								
	1.9 DTI 2.2 DTI 16V 2.5 CDTI 2.5 CDTI 2.5 CDTI 2.5 D 2.5 DTI 2.8 DTI 3.0 DTI	66 74 88 107 59 100		09.00 09.00 09.06 09.06 09.06 07.98 10.01 07.98 10.03	01.10 01.10 01.10 01.10 01.10 09.00 01.10 10.01 01.10	G1020627		23669 16,8 /S BOS
	1.9 DTI 2.2 DTI 16V 2.5 CDTI 2.5 CDTI 2.5 CDTI 2.5 D 2.5 DTI 2.8 DTI 3.0 DTI	66 74 88 107 59 100		09.00 09.00 09.06 09.06 09.06 07.98 10.01 07.98 10.03	01.10 01.10 01.10 01.10 01.10 09.00 01.10 10.01 01.10	G2112155		305 12,0 10,5 +S +C
<b>OPEL MOVANO B (10-)</b>								
	2.3 CDTI FWD 2.3 CDTI FWD 2.3 CDTI FWD 2.3 CDTI FWD 2.3 CDTI RWD 2.3 CDTI RWD 2.3 CDTI RWD 2.3 CDTI RWD	74 92 107 110 74 92 107 110		02.10 02.10 05.10 01.13 02.10 02.10 05.10 01.13		G1020905		25147 18,4 +/Wl BRE
	2.3 CDTI FWD 2.3 CDTI FWD 2.3 CDTI FWD 2.3 CDTI FWD 2.3 CDTI RWD 2.3 CDTI RWD 2.3 CDTI RWD 2.3 CDTI RWD	74 92 107 110 74 92 107 110		02.10 02.10 05.10 01.13 02.10 02.10 05.10 01.13	+ single tyre <sup>1)</sup> + single tyre <sup>1)</sup> + single tyre <sup>1)</sup> + single tyre <sup>1)</sup> + single tyre <sup>1)</sup> + single tyre <sup>1)</sup> + single tyre <sup>1)</sup> + single tyre <sup>1)</sup>	G1020907		25112 18,4 +/Wl BRE
<b>OPEL OMEGA B / Vauxhall Omega (94-03)</b>								
	2.0 2.0 16V		V1999999 V1999999	03.94 03.94	- special vehicles/ - Police <sup>2)</sup> - special vehicles/ - Police <sup>2)</sup>	G1020369		21411 17,5 + ATE
	2.0 2.0 16V 2.0 DTI 16V 2.2 16V 2.2 DTI 16V 2.5 DTI 2.5 TD 2.5 V6 2.6 V6 3.0 V6 3.2 V6			03.94 03.94 09.97 10.99 09.00 09.01 04.94 03.94 09.00 04.94 02.01	09.99 09.99 08.00 08.03 08.03 08.03 08.03 08.03 08.03 01.01 08.03	G1020271		21050 15,0 ATE
	2.0 2.0 16V 2.0 DTI 16V 2.2 16V 2.2 DTI 16V 2.5 DTI 2.5 TD 2.5 V6 2.6 V6 3.0 V6 3.2 V6			03.94 03.94 09.97 10.99 09.00 09.01 04.94 03.94 09.00 04.94 02.01	09.99 09.99 08.00 08.03 08.03 08.03 08.03 09.00 08.03 01.01 08.03	G2112131		286 12,0 10,0 +C
<b>OPEL SIGNUM / Vauxhall Signum (03-08)</b>								
	1.8 1.8 1.9 CDTI 1.9 CDTI 1.9 CDTI 2.0 DTI 2.0 Turbo 2.2 2.2 DTI 3.0 V6 CDTI 3.2 V6 2.8 V6 Turbo 2.8 V6 Turbo 3.0 V6 CDTI 3.0 V6 CDTI 3.2 V6	90 103 74 88 110 130 130 135 169 130 135 31068239		05.03 09.05 08.05 04.04 04.04 05.03 05.03 03.03 05.03 05.03 05.03 03.06 05.08 05.08 05.08 05.08		G1020836 G1020650	for br.caliper +steel piston <sup>3)</sup> for br.caliper +plastic piston <sup>4)</sup>	23738 20,1 +/WD 23402 20,1 +/WD 23404 20,6 +/WD ATE ATE
	1.8 1.8 1.9 CDTI 1.9 CDTI 1.9 CDTI 2.0 DTI	90 103 74 88 110		05.03 09.05 08.05 04.04 04.04 05.03	- sports suspension <sup>5)</sup> + sports suspension/ - Police <sup>6)</sup> - Police <sup>7)</sup> - sports suspension <sup>5)</sup> - sports suspension <sup>5)</sup> - sports suspension <sup>5)</sup>	G2125141		285 24,9 22,0 V L +S +C

<sup>1)</sup> + ruota singola / + roue simple / + cubierta simple / + Einfachbereifung

<sup>2)</sup> - veicoli speciali/ - Polizia / - véhicule spécial/ - Police / - vehiculo especial/ - Police / - Sonderfahrzeuge/ - Polizei

<sup>3)</sup> per pinza fr. +pistone acciaio / pour étrier f. +piston en acier / para pinza fr. +piston de acero / f. Bremssattel m.Stahlkolben

<sup>4)</sup> per pinza fr. +pistone plastica / pour étrier fr. +piston plastique / para pinza fr. + piston plástico / f. Bremssattel m.Kunststoffkolben

<sup>5)</sup> - sospensione sportiva / - châssis de sport / - suspensión deportiva / - Sportfahrwerk

<sup>6)</sup> + sospensione sportiva/ - Polizia / + châssis de sport/ - Police / + suspensión deportiva/ - Police / + Sportfahrwerk/ - Polizei

<sup>7)</sup> - Polizia / - voiture de police / - Police / - Polizei



OPEL SIGNUM / Vauxhall Signum (03-08)									
	2.2			03.03	05.08	- sports suspension <sup>1)</sup>	G2125141		285 24,9 22,0 V L +S +C
	2.2 DTI			05.03	05.08	- sports suspension <sup>1)</sup>			
	2.8 V6 Turbo	169	61000001		03.06		G2128164		314 28,0 25,0 V L +S +C
	2.8 V6 Turbo	130	31068239		05.08				
	3.0 V6 CDTI	135	61000001		05.08				
	3.2 V6		31068239		05.08				
	1.8	90	71041573		05.03		G1020670		23482 16,6 + ATE
	1.8	103	71041573		09.05				
	1.9 CDTI	74	71041573		08.05				
	1.9 CDTI	88	71041573		04.04				
	1.9 CDTI	110	71041573		04.04				
	2.0 DTI		71041573		05.03				
	2.0 Turbo		71041573		05.03				
	2.2		71041573		03.03				
	2.2 DTI		71041573		05.03				
	2.8 V6 Turbo		71041573		03.06				
	2.8 V6 Turbo	169	71041573		09.05				
	3.0 V6 CDTI	130	71041573		05.03				
	3.0 V6 CDTI	135	71041573		09.05				
	3.2 V6		71041573		05.03				
	1.8	90	71041574		05.08		G1020727		23482 16,6 + ATE
	1.8	103	71041574		05.08				
	1.9 CDTI	74	71041574		05.08				
	1.9 CDTI	88	71041574		05.08				
	1.9 CDTI	110	71041574		05.08				
	2.0 DTI		71041574		05.08				
	2.0 Turbo		71041574		05.08				
	2.2		71041574		05.08				
	2.2 DTI		71041574		05.08				
	2.8 V6 Turbo		71041574		05.08				
	2.8 V6 Turbo	169	71041574		05.08				
	3.0 V6 CDTI	130	71041574		05.08				
	3.0 V6 CDTI	135	71041574		05.08				
	3.2 V6		71041574		05.08				
	1.8	90			05.03		G2112157		278 11,9 10,0 +S +C
	1.8	103			09.05				
	1.9 CDTI	74			08.05				
	1.9 CDTI	88			04.04				
	1.9 CDTI	110			04.04				
	2.0 DTI				05.03				
	2.2				03.03				
	2.2 DTI				05.03				
	2.8 V6 Turbo				03.06				
	2.8 V6 Turbo	169			09.05				
3.0 V6 CDTI	135			09.05					
OPEL SPEEDSTER / Vauxhall VX220 (00-05)									
	2.0 Turbo				04.03	09.05	G2125119		288 25,0 22,0 V L +S +C
	2.2 16V				09.00	09.05			
	2.0 Turbo				04.03	09.05	G2125119		288 25,0 22,0 V L +S +C
	2.2 16V				09.00	09.05			
OPEL TIGRA / Vauxhall Tigra (94-00)									
	1.4 16V				07.94	12.00	G1020317		20547 16,5 +/WD ATE
	1.6 16V				07.94	08.98			
	1.4 16V				07.94	12.00	G2120140		256 20,0 17,0 V L +S +C
	1.6 16V				07.94	08.98			
OPEL TIGRA TWIN TOP / Vau. Tigra Twin Top (04-09)									
	1.3 CDTI	51			06.04	08.09	G1020545		23225 17,0 +/MI/Acc/S LUC
	1.4	66			06.04	08.09			
	1.8	92			06.04	08.09			
	1.3 CDTI	51			06.04	08.09	G2124166		260 24,0 21,0 V L +C
	1.4	66			06.04	08.09			
	1.8	92			06.04	08.09			
	1.3 CDTI	51	ORGA 6E999999		06.04		G1020560		23284 14,0 /WI/S LUC
	1.4	66	ORGA 6E999999		06.04				
	1.8	92	ORGA 6E999999		06.04				
OPEL VECTRA A / Vauxhall Cavalier (89-95)									
	1.4		N1038529		09.88		G1020015		20939 15,8 /WD DEL
	1.4		M5999999		09.88				
	1.6		N1038529		09.88				
	1.6		M5999999		09.88				
	1.7 D		N1038529		09.88				
	1.7 D		M5999999		09.88				
	1.7 TD		N1038529		09.88				
	1.7 TD		M5999999		09.88				
	1.8		N1038529		09.88				
	1.8		M5999999		09.88				

<sup>1)</sup> - sospensione sportiva / - châssis de sport / - suspensión deportiva / - Sportfahrwerk



**OPEL VECTRA A / Vauxhall Cavalier (89-95)**

	1.4	N5000001		08.95		G1020317		20547 16,5 +/WD	ATE
	1.4	N1038530		08.95					
	1.6	N5000001		08.95					
	1.6	N1038530		08.95					
	1.7 D	N5000001	R5999999						
	1.7 D	N1038530	R1999999						
	1.7 TD	N5000001	R5999999						
	1.7 TD	N1038530	R1999999						
	1.8	N5000001	R5999999						
	1.8	N1038530	R1999999						
	1.7 D	S5000001		08.95		G1020258		21190 17,5 +/WD	ATE
	1.7 D	S1000001		08.95					
	1.7 TD	S5000001		08.95					
	1.7 TD	S1000001		08.95					
	1.8	S5000001		08.95					
	1.8	S1000001		08.95					
	1.8 4x4			09.88	08.89				
	2.0			09.88	08.95				
	2.0 16V			09.88	08.95				
	2.0 Turbo			03.92	08.95		G1020369		21411 17,5 +
2.5 i			02.93	08.95					
	1.4		N1038529	09.88		G2113161		236 12,7 9,7 +S +C	
	1.4		M5999999	09.88					
	1.6		N1038529	09.88					
	1.6		M5999999	09.88					
	1.7 D		N1038529	09.88					
	1.7 D		M5999999	09.88					
	1.7 TD		N1038529	09.88					
	1.7 TD		M5999999	09.88					
	1.8		N1038529	09.88					
	1.8		M5999999	09.88					
	1.4	N5000001		08.95		G2120115		236 20,0 17,0 V L +S +C	
	1.4	N1038530		08.95					
	1.6	N5000001		08.95					
	1.6	N1038530		08.95					
	1.7 D	N5000001	R5999999			G2120140		256 20,0 17,0 V L +S +C	
	1.7 D	N1038530	R1999999						
	1.7 TD	N5000001	R5999999						
	1.7 TD	N1038530	R1999999						
	1.8	N5000001	R5999999						
	1.8	N1038530	R1999999						
	1.7 D	S5000001		08.95		G2124115		256 24,0 21,0 V L +S +C	
	1.7 D	S1000001		08.95					
	1.7 TD	S5000001		08.95					
	1.7 TD	S1000001		08.95					
	1.8	S5000001		08.95					
	1.8	S1000001		08.95					
	1.8 4x4			09.88	08.89				
	2.0			09.88	08.95				
	2.0 16V			09.88	08.95				
		1.8 4x4			09.88	08.89	G1020272		21140 15,0
2.0				09.88	08.95				
2.0 16V				09.88	08.95				
2.0 16V 4x4				09.88	08.95				
2.0 4x4				09.88	08.95				
2.0 Turbo				03.92	08.95				
2.5 i				02.93	08.95				

**OPEL VECTRA B / Vauxhall Vectra (96-02)**

	1.6		W7999999	09.95		G1020258		21190 17,5 +/WD	ATE
	1.6 16V		W7999999	09.95					
	1.7 TD			09.95	11.96				
	1.8 i 16V		W7999999	09.95					
	2.0 DI 16V		W7999999	11.96					
2.0 DTI 16V		W7999999	06.97						
	1.6	X1000001		04.02		G1020403		21829 20,3 +/WD	ATE
	1.6 16V	X1000001		04.02					
	1.8 i 16V	X1000001		04.02					
	2.0 16V			09.95	04.02				
	2.0 DI 16V	X1000001		04.02					
	2.0 DTI 16V	X1000001		04.02					
	2.2 16V			09.00	04.02				
	2.2 DTI 16V			09.00	04.02				
	2.5 V6			09.95	09.00				
	2.6 V6			09.00	04.02				
i 500 2.5	143		05.98	09.00		G1020403		21829 20,3 +/WD	ATE
	1.6		W7999999	09.95		G2124115		256 24,0 21,0 V L +S +C	
	1.6 16V		W7999999	09.95					
	1.7 TD			09.95	11.96				
	1.8 i 16V		W7999999	09.95					
	2.0 DI 16V		W7999999	11.96					
2.0 DTI 16V		W7999999	06.97						
	1.6	X1000001		04.02		G2125119		288 25,0 22,0 V L +S +C	
	1.6 16V	X1000001		04.02					
	1.8 i 16V	X1000001		04.02					
	2.0 16V			09.95	04.02				



















**OPEL VECTRA B / Vauxhall Vectra (96-02)**

	2.0 DI 16V		X1000001		04.02		G2125119		288 25,0 22,0 V L +S +C
	2.0 DTI 16V		X1000001		04.02				
	2.2 16V				09.00	04.02			
	2.2 DTI 16V				09.00	04.02			
	2.5 V6				09.95	09.00			
	2.6 V6				09.00	04.02			
	i 500 2.5	143			05.98	09.00			
	1.6 16V				09.95	04.02	G1020271		308 25,0 23,0 V L +S +C
	1.7 TD				09.95	11.96			
	1.8 i 16V				09.95	04.02			
	2.0 16V				09.95	04.02			
	2.0 DI 16V Caravan				11.96	04.02			
	2.0 DTI 16V				06.97	04.02			
	2.2 16V				09.00	04.02			
	2.2 DTI 16V				09.00	04.02			
	2.5 V6				09.95	09.00			
	2.6 V6				09.00	04.02			
	1.6 16V		W7999999	09.95			G2110225		270 10,0 8,0 +S +C
	1.7 TD			09.95	11.96				
	1.8 i 16V		W7999999	09.95					
	2.0 DI 16V Caravan		W7999999	11.96					
	2.0 DTI 16V		W7999999	06.97					



















**OPEL VECTRA C (F68,F69)/Vau. Vectra MK II (02-08)**















	1.6	74		08.05	10.08		G1020836 G1020650	for br.caliper +steel piston <sup>1)</sup> for br.caliper +plastic piston <sup>2)</sup>	23738 20,1 +/WD 23402 20,1 +/WD	ATE ATE
	1.6	77		01.06	10.08					
	1.6 16V			04.02	10.08					
	1.8	81		04.02	10.08					
	1.8	103		01.06	10.08					
	1.8 16V	90		04.02	10.08					
	1.9 CDTI	74		10.05	10.08					
	1.9 CDTI	88		04.04	10.08					
	1.9 CDTI	110		04.04	10.08					
	2.0 DTI 16V			04.02	10.08					
	2.0 Turbo			03.03	10.08					
	2.2 16V	108		04.02	10.08					
	2.2 direct	114		10.03	10.08					
2.2 DTI 16V			04.02	10.08						
	2.8 V6 Turbo	169		08.05	10.08		G1020756		23404 20,6 +/WD	ATE
	2.8 V6 Turbo	184		08.06	10.08					
	3.0 CDTI			05.03	10.08					
	3.0 V6 CDTI	135		08.05	10.08					
	3.2 V6			04.02	10.08					
	1.6	74		08.05	10.08		G2125141		285 24,9 22,0 V L +S +C	
	1.6	77		01.06	10.08					
	1.6 16V			04.02	10.08					
	1.8	81		04.02	10.08	- sports suspension <sup>3)</sup>				
	1.8	103		01.06	10.08	+ sports suspension/ - Police <sup>4)</sup>				
	1.8 16V	90		04.02	10.08	- sports suspension <sup>3)</sup>				
	1.9 CDTI	74		10.05	10.08	- Police <sup>5)</sup>				
	1.9 CDTI	88		04.04	10.08					
	1.9 CDTI	110		04.04	10.08					
	2.0 DTI 16V			04.02	10.08					
	2.2 16V	108		04.02	10.08	- sports suspension <sup>3)</sup>				
	2.2 direct	114		10.03	10.08	- sports suspension <sup>3)</sup>				
	2.2 DTI 16V			04.02	10.08	- sports suspension <sup>3)</sup>				
	2.8 V6 Turbo	169	61000001		10.08		G2128164		314 28,0 25,0 V L +S +C	
	2.8 V6 Turbo	184		08.06	10.08					
	3.0 CDTI		31070294		10.08					
	3.0 V6 CDTI	135	61000001		10.08					
	3.2 V6		31070294		10.08					
	1.6	74		08.05	10.08		G1020670		23482 16,6 +	ATE
	1.6	77		01.06	10.08					
	1.6 16V			04.02	10.08					
	1.8	81		04.02	10.08					
	1.8	103		01.06	10.08					
	1.8 16V	90		04.02	10.08					
	1.9 CDTI	74		10.05	10.08					
	1.9 CDTI	88		04.04	10.08					
	1.9 CDTI	110		04.04	10.08					
	2.0 DTI 16V			04.02	10.08					
	2.0 Turbo			03.03	10.08					
	2.2 16V	108		04.02	10.08					
	2.2 direct	114		10.03	10.08					
2.2 DTI 16V			04.02	10.08						
	2.8 V6 Turbo	169		08.05	10.08					
	2.8 V6 Turbo	184		08.06	10.08					
	2.8 V6 Turbo OPC	188		08.05	10.08					
	3.0 CDTI			05.03	10.08					
	3.0 V6 CDTI	135		08.05	10.08					
	3.2 V6			04.02	10.08					
					10.08					
	1.6	74		08.05	10.08		G2112157		278 11,9 10,0 +S +C	
	1.6	77		01.06	10.08					
	1.6 16V			04.02	10.08					
	1.8	81		04.02	10.08					
	1.8	103		01.06	10.08					

1) per pinza fr. +pistone acciaio / pour étrier f. +piston en acier / para pinza fr. +pistón de acero / f. Bremssattel m.Stahlkolben  
2) per pinza fr. +pistone plastica / pour étrier fr. +piston plastique / para pinza fr. + piston plástico / f. Bremssattel m.Kunststoffkolben  
3) - sospensione sportiva / - châssis de sport / - suspensión deportiva / - Sportfahrwerk  
4) + sospensione sportiva / - Polizia / + châssis de sport / - Police / + suspensión deportiva / - Police / + Sportfahrwerk / - Polizei  
5) - Polizia / - voiture de police / - Police / - Polizei

							
<b>OPEL VECTRA C (F68,F69)/Vau. Vectra MK II (02-08)</b>							
	1.8 16V	90		04.02	10.08	G2112157	278 11,9 10,0 +S +C
	1.9 CDTI	74		10.05	10.08		
	1.9 CDTI	88		04.04	10.08		
	1.9 CDTI	110		04.04	10.08		
	2.0 DTI 16V			04.02	10.08		
	2.0 Turbo			03.03	10.08		
	2.2 16V	108		04.02	10.08		
	2.2 direct	114		10.03	10.08		
	2.2 DTI 16V			04.02	10.08		
	2.8 V6 Turbo	169		08.05	10.08		
	2.8 V6 Turbo	184		08.06	10.08		
	2.8 V6 Turbo OPC	188		08.05	10.08		
	3.0 CDTI			05.03	10.08		
	3.0 V6 CDTI	135		08.05	10.08		
	3.2 V6			04.02	10.08		
<b>OPEL VECTRA C Caravan (F35) / Vau. MK II (03-08)</b>							
	1.6	77		06.06	10.08	G1020836	for br.caliper +steel piston <sup>1)</sup>
	1.6 16V	74		10.03	10.08	G1020650	for br.caliper +plastic piston <sup>2)</sup>
	1.8	81		04.04	10.08		23738 20,1 +/WD
	1.8	103		01.06	10.08		23402 20,1 +/WD
	1.8 16V	90		10.03	10.08		
	1.9 CDTI	74		10.05	10.08		
	1.9 CDTI	88		04.04	10.08		
	1.9 CDTI	110		04.04	10.08		
	2.0 DTI 16V	74		10.03	10.08		
	2.0 Turbo	129		10.03	10.08		
	2.2 16V	108		10.03	10.08		
	2.2 direct	114		10.03	10.08		
	2.2 DTI 16V	92		10.03	10.08		
	2.8 V6 Turbo	169		08.05	10.08	G1020756	23404 20,6 +/WD
	2.8 V6 Turbo	184		11.06	10.08		ATE
	3.0 V6 CDTI	130		10.03	10.08		
	3.0 V6 CDTI	135		08.05	10.08		
	3.2 V6	155		10.03	10.08		
	1.6	77		06.06	10.08	G2125141	285 24,9 22,0 V L +S +C
	1.6 16V	74		10.03	10.08		
	1.8	81		04.02	10.08		- sports suspension <sup>3)</sup>
	1.8	103		01.06	10.08		+ sports suspension/ - Police <sup>4)</sup>
	1.8 16V	90		10.03	10.08		- sports suspension <sup>3)</sup>
	1.9 CDTI	74		10.05	10.08		- sports suspens./ - Police <sup>5)</sup>
	1.9 CDTI	88		04.04	10.08		- sports suspens./ - Police <sup>5)</sup>
	1.9 CDTI	110		04.04	10.08		- sports suspension <sup>3)</sup>
	2.0 DTI 16V	74		10.03	10.08		
	2.2 16V	108		10.03	10.08		- sports suspension <sup>3)</sup>
	2.2 direct	114		10.03	10.08		- sports suspension <sup>3)</sup>
	2.2 DTI 16V	92		10.03	10.08		- sports suspension <sup>3)</sup>
	2.8 V6 Turbo	169	61000001		10.08	G2128164	314 28,0 25,0 V L +S +C
	2.8 V6 Turbo	184		11.06	10.08		
	3.0 V6 CDTI	130	31070294		10.08		
	3.0 V6 CDTI	135		08.05	10.08		
	3.2 V6	155	31070294		10.08		
	1.6	77		06.06	10.08	G1020670	23482 16,6 +
	1.6 16V	74		10.03	10.08		ATE
	1.8	81		04.02	10.08		
	1.8	103		01.06	10.08		
	1.8 16V	90		10.03	10.08		
	1.9 CDTI	74		10.05	10.08		
	1.9 CDTI	88		04.04	10.08		
	1.9 CDTI	110		04.04	10.08		
	2.0 DTI 16V	74		10.03	10.08		
	2.0 Turbo	129		10.03	10.08		
	2.2 16V	108		10.03	10.08		
	2.2 direct	114		10.03	10.08		
	2.2 DTI 16V	92		10.03	10.08		
	2.8 V6 Turbo	169		08.05	10.08		
	2.8 V6 Turbo	184		11.06	10.08		
	2.8 V6 Turbo OPC	188		08.05	10.08		
	2.8 V6 Turbo OPC	206		06.06	10.08		
	3.0 V6 CDTI	130		10.03	10.08		
	3.0 V6 CDTI	135		08.05	10.08		
	3.2 V6	155		10.03	10.08		
	1.6	77		06.06	10.08	G2112157	278 11,9 10,0 +S +C
	1.6 16V	74		10.03	10.08		
	1.8	81		04.02	10.08		
	1.8	103		01.06	10.08		
	1.8 16V	90		10.03	10.08		
	1.9 CDTI	74		10.05	10.08		
	1.9 CDTI	88		04.04	10.08		
	1.9 CDTI	110		04.04	10.08		
	2.0 DTI 16V	74		10.03	10.08		
	2.0 Turbo	129		10.03	10.08		
	2.2 16V	108		10.03	10.08		
	2.2 direct	114		10.03	10.08		
	2.2 DTI 16V	92		10.03	10.08		
	2.8 V6 Turbo	169		08.05	10.08		
	2.8 V6 Turbo	184		11.06	10.08		

1) per pinza fr. +pistone acciaio / pour étrier f. +piston en acier / para pinza fr. +pistón de acero / f. Bremssattel m.Stahlkolben  
2) per pinza fr. +pistone plastica / pour étrier fr. +piston plastique / para pinza fr. + piston plástico / f. Bremssattel m.Kunststoffkolben  
3) - sospensione sportiva / - châssis de sport / - suspensión deportiva / - Sportfahrwerk  
4) + sospensione sportiva/ - Polizia / + châssis de sport/ - Police / + suspensión deportiva/ - Police / + Sportfahrwerk/ - Polizei  
5) - sospensione sportiva/ - Polizia / - châssis de sport/ - Police / - suspens.deportiva/ - Police / - Sportfahrwerk/ - Polizei

									
<b>OPEL VECTRA C Caravan (F35) / Vau. MK II (03-08)</b>									
	2.8 V6 Turbo OPC 2.8 V6 Turbo OPC 3.0 V6 CDTI 3.0 V6 CDTI 3.2 V6	188 206 130 135 155		08.05 10.08 06.06 10.03 10.08 08.05 10.08 10.03 10.08			G2112157		278 11,9 10,0 +S +C
<b>OPEL VIVARO (01-)</b>									
	1.9 CDTI 1.9 CDTI 1.9 Di 2.0 2.0 16V 2.0 CDTI 2.0 CDTI 2.0 CDTI 2.5 CDTI 2.5 CDTI 2.5 CDTI 2.5 DTi	60 74 60 86 88 66 84 84 84 99 107 99		08.01 08.01 08.06 08.06 08.01 08.06 08.06 08.06 08.06 05.03 08.06 08.06			G1020633		23099 18,4 /S LUC
	1.9 CDTI 1.9 CDTI 1.9 Di 2.0 2.0 16V 2.0 CDTI 2.0 CDTI 2.0 CDTI 2.5 CDTI 2.5 CDTI 2.5 CDTI 2.5 DTi	60 74 60 86 88 66 84 84 84 99 107 99		08.01 08.01 08.06 08.06 08.01 08.06 08.06 08.06 08.06 05.03 08.06 08.06			G2128132		305 28,0 24,0 V L +S +C
	1.9 CDTI 1.9 CDTI 1.9 Di 2.0 2.0 16V 2.0 CDTI 2.0 CDTI 2.0 CDTI 2.5 CDTI 2.5 CDTI 2.5 CDTI 2.5 DTi	60 74 60 86 88 66 84 84 84 99 107 99		08.01 08.01 08.06 08.06 08.01 08.06 08.06 08.06 08.06 05.03 08.06 08.06			G1020529		23980 16,5 /WD/S LUC
<b>OPEL ZAFIRA I / Vauxhall Zafira I (99-05)</b>									
	1.6 16V 1.8 16V 2.0 DI 16V 2.0 DTI 16V 2.2 16V 2.2 DTI 16V 2.0 16V OPC			04.99 06.05 04.99 06.05 10.99 06.05 06.00 06.05 09.00 06.05 01.02 06.05 09.01 06.05			G1020550 G1020542	+ ABS - ABS	23057 20,2 +/WD 23063 17,5 +/WI ATE ATE
	1.6 16V 1.8 16V 2.0 DI 16V 2.0 DTI 16V 2.2 16V 2.2 DTI 16V 2.0 16V OPC			04.99 06.05 04.99 06.05 10.99 06.05 06.00 06.05 09.00 06.05 01.02 06.05 09.01 06.05			G1020642 G2125131		23116 19,8 +/WI ATE 280 24,8 22,0 V L +S +C
	1.6 16V 1.8 16V 2.0 16V OPC 2.0 DI 16V 2.0 DTI 16V 2.2 16V 2.2 DTI 16V			04.99 06.05 04.99 06.05 10.99 06.05 06.00 06.05 09.00 06.05 01.02 06.05	+ D A Gh		G1020554 G1020610		23258 16,5 +/WI/Acc/S 23417 15,3 +/WI/Acc/S BOS LUC
	1.6 16V 1.8 16V 2.0 16V OPC 2.0 DI 16V 2.0 DTI 16V 2.2 16V 2.2 DTI 16V			04.99 06.05 04.99 06.05 09.01 06.05 10.99 06.05 06.00 06.05 09.00 06.05 01.02 06.05	+ D A Gh		G2110250		264 9,8 8,0 +S +C
<b>OPEL ZAFIRA II / Vauxhall Zafira II (05-11)</b>									
	1.6 1.6 1.6 CNG 1.6 CNG Turbo 1.7 CDTI 1.7 CDTI 1.8 1.9 CDTI 1.9 CDTI 1.9 CDTI 2.0 2.0 Turbo 2.2	77 85 69 110 81 92 103 74 88 110 125 147 110		07.05 10.11 12.07 10.11 01.06 10.11 02.09 10.11 12.07 10.11 12.07 10.11 07.05 10.11 07.05 10.11 07.05 10.11 07.05 10.11 07.05 10.11 07.05 10.11 07.05 10.11			G1020765		23832 20,2 +/WI ATE

										
<b>OPEL ZAFIRA II / Vauxhall Zafira II (05-11)</b>										
	2.0 OPC	177		09.05	10.11		G1020836 G1020650	for br.caliper +steel piston <sup>1)</sup> for br.caliper +plastic piston <sup>2)</sup>	23738 20,1 +/WD 23402 20,1 +/WD	ATE ATE
	1.6	77		07.05	10.11		G2125131		280 24,8 22,0 V L +S +C	
	1.6	85		12.07	10.11					
	1.8	103		07.05	10.11					
	1.6 CNG	69		01.06	10.11		G2125142		308 25,0 23,0 V L +S +C	
	1.6 CNG Turbo	110		02.09	10.11					
	1.7 CDTi	81		12.07	10.11					
	1.7 CDTi	92		12.07	10.11					
	1.9 CDTi	74		07.05	10.11					
	1.9 CDTi	88		07.05	10.11					
	1.9 CDTi	110		07.05	10.11					
	2.0	125		07.05	10.11					
	2.0 Turbo	147		07.05	10.11					
	2.2	110		07.05	10.11					
	1.6	77		07.05	10.11		G1020610		23417 15,3 +/Wl/Acc/S	LUC
	1.6	85		12.07	10.11					
	1.6 CNG	69		01.06	10.11					
	1.6 CNG Turbo	110		02.09	10.11					
	1.7 CDTi	81		12.07	10.11					
	1.7 CDTi	92		12.07	10.11					
	1.8	103		07.05	10.11					
	1.9 CDTi	74		07.05	10.11					
	1.9 CDTi	88		07.05	10.11					
	1.9 CDTi	110		07.05	10.11					
	2.0	125		07.05	10.11					
	2.0 OPC	177		09.05	10.11					
	2.0 Turbo	147		07.05	10.11					
	2.2	110		07.05	10.11					
	1.6	77		07.05	10.11		G2110250		264 9,8 8,0 +S +C	
	1.6	85		12.07	10.11					
	1.7 CDTi	81		12.07	10.11					
	1.7 CDTi	92		12.07	10.11					
	1.8	103		07.05	10.11					
	1.9 CDTi	74		07.05	10.11					
	1.9 CDTi	88		07.05	10.11					
	1.9 CDTi	110		07.05	10.11					
	2.0	125		07.05	10.11					
	2.0 Turbo	147	52999999	07.05	10.11					
	2.2	110		07.05	10.11					
<b>OPEL ZAFIRA III Tourer / Vauxhall Zafira III Tourer (11-)</b>										
	1.4 T	88		11.11			G1020928	+ 16" wheel <sup>3)</sup>	24034 19,1 +/Wl/Acc	
	1.4 T	103		11.11						
	1.4 T LPG	103		11.11						
	1.6 CDTi ecoFLEX	100		03.13						
	1.6 SIDI	125		12.12						
	1.6 T CNG	110		11.11						
	1.8			11.11						
	1.8	103		11.11						
	1.8 LPG	101		11.11						
	2.0 CDTi			11.11						
	2.0 CDTi	81		11.11						
	2.0 CDTi	96		11.11						
	2.0 CDTi BiTurbo	143		12.12						
	1.4 T	88		11.11			G1201145	+ 17" wheel <sup>4)</sup>	24412 19,0 +/Wl/Acc	MAN
	1.4 T	103		11.11						
	1.4 T LPG	103		11.11						
	1.6 CDTi ecoFLEX	100		03.13						
	1.6 SIDI	125		12.12						
	1.6 T CNG	110		11.11						
	1.8			11.11						
	1.8	103		11.11						
	1.8 LPG	101		11.11						
	2.0 CDTi			11.11						
	2.0 CDTi	81		11.11						
	2.0 CDTi	96		11.11						
	2.0 CDTi BiTurbo	143		12.12						
	1.4 T	88		11.11			G1020953	+ 16" wheel <sup>3)</sup>	25096 17,0 +/Wl/Acc	ATE
	1.4 T	103		11.11						
	1.4 T LPG	103		11.11						
	1.6 CDTi ecoFLEX	100		03.13						
	1.6 SIDI	125		12.12						
	1.6 T CNG	110		11.11						
	1.8			11.11						
	1.8	103		11.11						
	1.8 LPG	101		11.11						
	2.0 CDTi			11.11						
	2.0 CDTi	81		11.11						
	2.0 CDTi	96		11.11						
	2.0 CDTi BiTurbo	143		12.12						

<sup>1)</sup> per pinza fr. +pistone acciaio / pour étrier f. +piston en acier / para pinza fr. +pistón de acero / f. Bremssattel m.Stahlkolben  
<sup>2)</sup> per pinza fr. +pistone plastica / pour étrier fr. +piston plastique / para pinza fr. + pistón plástico / f. Bremssattel m.Kunststoffkolben  
<sup>3)</sup> + ruota 16" / + roue 16" / + rueda 16" / + 16" Rad  
<sup>4)</sup> + ruota 17" / + roue 17" / + rueda 17" / + 17" Rad



**PEUGEOT 106 (91-96)**

	1.0		S 50994342	<b>08.91</b>	- ABS	G1020275	for 3 bore wheel rim <sup>1)</sup>	21191 16,8 +/WI	ATE BDX
	1.1	44	S 50994342	<b>08.91</b>	- ABS	G1020296	for 4 bore wheel rim <sup>2)</sup>	20906 18,0 +/WI	
	1.0		S 50994343	<b>04.96</b>	- ABS	G1020443	for 3 bore wheel rim <sup>1)</sup>	21857 17,7	ATE BDX
	1.1	44	S 50994343	<b>04.96</b>	- ABS	G1020215	for 4 bore wheel rim <sup>2)</sup>	20905 18,0 +/WD	
	1.0			<b>08.91</b>	+ ABS	G1020296		20906 18,0 +/WI	BDX
	1.1	44		<b>04.96</b>	+ ABS				
	1.4	55	S 50994342	<b>08.91</b>	- ABS	G1020296		20906 18,0 +/WI	BDX
	1.4 D	37	S 50994342	<b>08.92</b>	- ABS				
	1.5 D		S 50994342	<b>06.94</b>	- ABS				
	1.6	65	S 50994342	<b>06.93</b>	- ABS				
	1.4	55	S 50994343		<b>04.96</b>	G1020215		20905 18,0 +/WD	BDX
	1.4 D	37	S 50994343		<b>04.96</b>				
	1.5 D		S 50994343		<b>04.96</b>				
	1.6	65	S 50994343		<b>04.96</b>				
	1.3 Rallye	72	S 51132346	<b>10.93</b>		G1020296		20906 18,0 +/WI	BDX
	1.4	55	S 51132346	<b>08.91</b>	+ ABS				
	1.4	69		<b>08.91</b>	<b>04.96</b>				
	1.4 D	37	S 51132346	<b>08.92</b>	+ ABS				
	1.5 D		S 51132346	<b>06.94</b>	+ ABS				
	1.6	65	S 51132346	<b>06.93</b>	+ ABS				
	1.6	76	S 51132346	<b>01.94</b>					
	1.3 Rallye	72	S 51132347		<b>04.96</b>	G1020293		21827 17,3 +	ATE
	1.4	55	S 51132347		<b>04.96</b>	+ ABS			
	1.4 D	37	S 51132347		<b>04.96</b>	+ ABS			
	1.5 D		S 51132347		<b>04.96</b>	+ ABS			
	1.6	65	S 51132347		<b>04.96</b>	+ ABS			
	1.6	76	S 51132347		<b>04.96</b>				

**PEUGEOT 106 (96-04)**

	1.0 i	33		<b>05.96</b>	<b>03.04</b>	G1020275	for 3 bore wheel rim <sup>1)</sup>	21191 16,8 +/WI	ATE ATE BDX BDX
	1.0 i	37		<b>01.97</b>	<b>03.04</b>	G1020443	for 3 bore wheel rim <sup>1)</sup>	21857 17,7	
	1.1	42		<b>09.00</b>	<b>10.02</b>	G1020296	for 4 bore wheel rim <sup>2)</sup>	20906 18,0 +/WI	
	1.1 i	40		<b>01.97</b>	<b>03.04</b>	G1020215	for 4 bore wheel rim <sup>2)</sup>	20905 18,0 +/WD	
	1.1 i	44		<b>05.96</b>	<b>03.04</b>				
	1.4 i	55		<b>05.96</b>	<b>03.04</b>	G1020296		20906 18,0 +/WI	
	1.5 D	40		<b>05.96</b>	<b>03.04</b>	G1020215		20905 18,0 +/WD	
	1.5 D	42		<b>10.00</b>	<b>03.04</b>				
	1.6	65		<b>05.96</b>	<b>03.04</b>				
	1.6	74		<b>05.96</b>	<b>03.04</b>	G1020293		21827 17,3 +	
1.6 16V	87		<b>05.96</b>	<b>03.04</b>					
	1.0 i	33		<b>05.96</b>	<b>03.04</b>	G2108107	for 3 bore wheel rim <sup>1)</sup>	238 8,0 6,0 +S +C	
	1.0 i	37		<b>01.97</b>	<b>03.04</b>	G2110187	for 4 bore wheel rim <sup>2)</sup>	247 10,0 9,0 +S +C	
	1.1	42		<b>09.00</b>	<b>10.02</b>				
	1.1 i	40		<b>01.97</b>	<b>03.04</b>				
	1.1 i	44		<b>05.96</b>	<b>03.04</b>				
	1.4 i	55		<b>05.96</b>	<b>03.04</b>	G2110187		247 10,0 9,0 +S +C	
	1.5 D	40		<b>05.96</b>	<b>03.04</b>				
	1.5 D	42		<b>10.00</b>	<b>03.04</b>				
	1.6	65		<b>05.96</b>	<b>03.04</b>				
	1.6 electronic vehicle	20		<b>04.96</b>	<b>07.04</b>				
1.6	74		<b>05.96</b>	<b>03.04</b>	G2120132		247 20,4 18,5 V +S +C		
1.6 16V	87		<b>05.96</b>	<b>03.04</b>					
	1.6	74		<b>05.96</b>	<b>03.04</b>	G1020216		20973 11,0 +	BDX
	1.6 16V	87		<b>05.96</b>	<b>03.04</b>				
	1.6	74		<b>05.96</b>	<b>03.04</b>	G2108106		247 8,0 6,0 +S +C	
	1.6 16V	87		<b>05.96</b>	<b>03.04</b>				

**PEUGEOT 107 (05-)**

	1.0	50		<b>06.05</b>		G1020830		23959 17,0 /Acc/S	BDS
	1.4 HDi	40		<b>06.05</b>					
	1.0	50		<b>06.05</b>		G2120180		247 20,0 18,0 V +S +C	
	1.4 HDi	40		<b>06.05</b>					

<sup>1)</sup> per cerchione a 3 fori / pour jante à 3 trous / para Llantas de 3 taladros / für 3-Loch-Felge  
<sup>2)</sup> per cerchione a 4 fori / pour jante à 4 trous / para Llantas de 4 taladros / für 4-Loch-Felge

























PEUGEOT 206 CC (00-07)									
	1.6 16V 1.6 HDi 110 2.0 16V	80 80 100		09.00 04.05 09.00	01.07 01.07 01.07	G1020522		20974 10,7	BDX
	1.6 16V 1.6 HDi 110 2.0 16V	80 80 100		09.00 04.05 09.00	01.07 01.07 01.07	G2108106		247 8,0 6,0 +S +C	
PEUGEOT 206 SW (02-07)									
	1.6 16V 2.0 HDi	80 ORGA 10809 66 ORGA 10809		05.07 05.07		G1020570		23346 19,0 /WD/S	LUC
	1.1 1.4 1.4 HDi	44 55 50		07.02 07.02 07.02	05.07 05.07 05.07	G2113185		248 13,0 11,0 +S +C	
	1.4 1.4 HDi	55 50		07.02 07.02	05.07 05.07	G2120132		247 20,4 18,5 V +S +C	
	1.4 16V 1.6 16V 1.6 HDi 110 2.0 HDi 2.0 S16	65 80 80 66 100		10.03 07.02 05.04 07.02 07.02	05.07 05.07 05.07 05.07 05.07	G2122194		266 22,0 20,0 V +S +C	
	1.4 16V 1.6 16V 1.6 HDi 110 2.0 S16	65 80 80 100		10.03 07.02 05.04 07.02	05.07 05.07 05.07 05.07	G1020522		20974 10,7	BDX
	1.4 16V 1.6 16V 1.6 HDi 110 2.0 S16	65 80 80 100		10.03 07.02 05.04 07.02	05.07 05.07 05.07 05.07	G2108106		247 8,0 6,0 +S +C	
PEUGEOT 206 PLUS (09-13)									
	1.1 1.4 HDi eco 70 1.4 i 1.4 i	44 50 54 55		01.09 01.09 09.10 01.09	05.13 + ⊕ 05.13 + ⊕ 05.13 + ⊕ 05.13 + ⊕	G2120132		247 20,4 18,5 V +S +C	
	1.1 1.4 HDi eco 70 1.4 i 1.4 i	44 50 54 55		01.09 01.09 09.10 01.09	05.13 - ⊖ 05.13 - ⊖ 05.13 - ⊖ 05.13 - ⊖	G2113185		248 13,0 11,0 +S +C	
PEUGEOT 207 Saloon (06-12)									
	1.6 16V RC 1.4 16V VTi 1.6 16V 1.6 16V Turbo 1.6 16V Turbo 1.6 16V VTi 1.6 HDi 1.6 HDi 1.6 HDi 110	128 70 80 110 115 88 66 80 82		10.06 08.07 02.06 02.06 01.10 02.07 02.06 02.06 08.09	06.12 06.12 06.12 06.12 06.12 06.12 06.12 06.12 06.12	G1020745 G1020735		23589 19,1 + 23600 19,4 /Acc/S	ATE BOS
	1.4 1.4 1.4 16V 1.4 HDi 1.6 HDi 1.6 HDi	53 55 65 50 66 ORGA 11743 68		02.06 09.07 02.06 02.06 06.12 11.09	06.12 06.12 06.12 06.12 06.12 06.12	G2122194		266 22,0 20,0 V +S +C	
	1.4 16V VTi 1.6 16V 1.6 16V Turbo 1.6 16V Turbo 1.6 16V VTi 1.6 HDi 1.6 HDi 1.6 HDi 110	70 80 110 115 88 66 80 82	ORGA 11742	08.07 02.06 02.06 01.10 10.06 02.06 02.06 08.09	06.12 06.12 06.12 06.12 06.12 06.12 06.12 06.12	G2126120		283 26,0 24,0 V +S +C	
	1.6 16V 1.6 16V Turbo 1.6 16V Turbo 1.6 16V VTi 1.6 HDi 1.6 HDi 1.6 HDi 110	80 110 115 88 66 80 82	ORGA 11634 ORGA 11634 ORGA 11634 ORGA 11634 ORGA 11634 ORGA 11634 ORGA 11634	02.06 02.06 10.09 10.06 02.06 02.06 08.09		G1020630 G1020995		24150 17,6 /S 24150 17,6 /Acc	BOS BOS
	1.6 16V RC	128	ORGA 11627	02.07		G1020995		24150 17,6 /Acc	BOS
	1.6 16V 1.6 16V RC 1.6 16V Turbo 1.6 16V Turbo 1.6 16V VTi 1.6 HDi 1.6 HDi 1.6 HDi 110	80 ORGA 11635 128 ORGA 11628 110 ORGA 11635 115 ORGA 11635 88 ORGA 11635 66 ORGA 11635 80 ORGA 11635 82 ORGA 11635		06.12 06.12 06.12 06.12 06.12 06.12 06.12 06.12		G1020920		23554 16,8 /WD/Acc/S	LUC

1) - dischi ventilati / - disques ventilés / - disco ventilado / - belüftete Scheiben  
2) + dischi ventilati / + disques ventilés / + disco ventilado / + belüftete Scheiben

							
<b>PEUGEOT 207 CC (07-)</b>							
	1.6 16V 1.6 16V Turbo 1.6 16V Turbo 1.6 HDi 1.6 HDi	88 110 115 80 82		02.07 02.07 10.09 02.07 08.09		G1020735	23600 19,4 /Acc/S BOS
	1.6 16V 1.6 16V Turbo 1.6 16V Turbo 1.6 HDi 1.6 HDi	88 110 115 80 82		02.07 02.07 10.09 02.07 08.09		G2126120	283 26,0 24,0 V +S +C
	1.6 16V 1.6 16V Turbo 1.6 16V Turbo 1.6 HDi	88 110 115 80	ORGA 1164182 ORGA 1163482 ORGA 1163482 ORGA 1163482	02.07 02.07 10.09 02.07		G1020995	24150 17,6 /Acc BOS
	1.6 16V 1.6 HDi	88 80	ORGA 1164282 ORGA 1163582			G1020920	23554 16,8 /WD/Acc/S LUC
	1.6 16V Turbo 1.6 16V Turbo 1.6 HDi	110 115 82	ORGA 1163582 ORGA 1163582		08.09	G1020920	23554 16,8 /WD/Acc/S LUC
<b>PEUGEOT 207 SW (07-)</b>							
	1.4 i 16V 1.6 HDi 1.6 HDi 1.6 HDi FAP 110 1.6 HDi FAP 90 1.6 i 16V 1.6 16V RC	70 68 82 80 66 88 128		06.07 11.09 08.09 06.07 06.07 06.07 11.07		G1020735 G1020745	23600 19,4 /Acc/S BOS 23589 19,1 + ATE
	1.4 i 1.4 i 1.4 i 16V 1.6 HDi 1.6 HDi 1.6 HDi FAP 110 1.6 HDi FAP 90 1.6 i 16V	54 54 70 68 82 80 66 88	ORGA 11402 ORGA 11403	06.07		G2122194 G2122194 G2126120	266 22,0 20,0 V +S +C 266 22,0 20,0 V +S +C 283 26,0 24,0 V +S +C
	1.6 16V RC 1.6 HDi 1.6 HDi FAP 110 1.6 HDi FAP 90 1.6 i 16V	128 82 80 66 88	ORGA 1162781 ORGA 1163175 ORGA 1163482 ORGA 1163482 ORGA 1162781	11.07 08.09 06.07 06.07		G1020995	24150 17,6 /Acc BOS
	1.6 16V RC 1.6 HDi 1.6 HDi 1.6 HDi FAP 110 1.6 HDi FAP 90 1.6 i 16V	128 68 82 80 66 88	ORGA 1162881 ORGA 12774 ORGA 1163176 ORGA 1163582 ORGA 1163482 ORGA 1162881	11.09		G1020920	23554 16,8 /WD/Acc/S LUC
	1.6 HDi 1.6 HDi FAP 90	68 66	ORGA 12775 ORGA 12775			G1020920	23554 16,8 /WD/Acc/S LUC
<b>PEUGEOT 208 (12-)</b>							
	1.0 VTi 1.2 VTi 1.4 HDi 1.4 VTi 1.6 e-HDi 1.6 e-HDi 1.6 THP 1.6 VTi	50 60 50 70 68 84 115 88		01.12 01.12 01.12 01.12 01.12 01.12 01.12 01.12	+ brake disc diameter 302 mm <sup>1)</sup> + brake disc diameter 302 mm <sup>1)</sup> + brake disc diameter 302 mm <sup>1)</sup> + brake disc diameter 302 mm <sup>1)</sup> + brake disc diameter 302 mm <sup>1)</sup> + brake disc diameter 302 mm <sup>1)</sup> + brake disc diameter 302 mm <sup>1)</sup> + brake disc diameter 302 mm <sup>1)</sup>	G1020745	23589 19,1 + ATE
	1.0 VTi 1.2 VTi 1.4 HDi 1.4 VTi 1.6 e-HDi 1.6 e-HDi 1.6 THP 1.6 VTi	50 60 50 70 68 84 115 88		01.12 01.12 01.12 01.12 01.12 01.12 01.12 01.12		G2122194	266 22,0 20,0 V +S +C
	1.0 VTi 1.2 VTi 1.4 HDi 1.4 VTi 1.6 e-HDi 1.6 e-HDi 1.6 GTi 1.6 THP 1.6 VTi	50 60 50 70 68 84 147 115 88		01.12 01.12 01.12 01.12 01.12 01.12 03.13 01.12 01.12		G1020920	23554 16,8 /WD/Acc/S LUC
<b>PEUGEOT 301 (12-)</b>							
	1.2 VTi 72 1.6 HDi 92 1.6 VTi 115	53 68 85		11.12 11.12 11.12		G2113184 G2122194	266 13,0 11,0 +S +C 266 22,0 20,0 V +S +C

<sup>1)</sup> + disco fr.diam. 302mm / + disques fr.diam. 302mm / + disco fr.diam. 302mm / + Bremsscheibendurchm. 302 mm





**PEUGEOT 306 Saloon (3/5-door) (93-01)**

	1.1	44		03.94	04.97	- ABS	G1020295		20905 18,0 +/Wl	BDX
	1.4	55		03.93	04.97	- ABS				
	1.1	44		03.94	04.97	+ ABS	G1020292		21430 17,3 +/Wl	ATE
	1.4	55	ORGA 08575	03.93		+ ABS/ - Entreprise				
	1.4 Entreprise	55		03.93	05.01		G1020293		21827 17,3 +	ATE
	1.6	65	ORGA 08575	03.93						
	1.6	65		05.00	10.00	- ABS				
	1.6	72		10.00	05.01	- ABS				
	1.8	74	ORGA 08575	03.93						
	1.8	74	ORGA 08576		05.01	- ABS				
	1.8 D	43		03.93	05.01					
	1.9 D	47		05.93	05.01					
	1.9 D	50		06.94	05.01					
	1.9 D	51	ORGA 08575	09.98						
	1.9 D	51	ORGA 08576		05.01	- ABS				
	1.9 D	55		03.98	05.01					
	1.9 D Entreprise			09.98	10.00	+ ABS				
	1.9 TD	66		10.93	05.01					
	1.4	55	ORGA 08576		05.01	+ ABS	G1020513		23332 18,0 +/Wl/S	BOS
	1.6	65	ORGA 08576		10.00	+ ABS				
	1.6	72		10.00	05.01	+ ABS	G1020451		23124 19,0 +/Wl/S	LUC
	1.8	74	ORGA 08576		05.01	+ ABS				
	1.8 16V	81		03.97	05.01					
	1.9 D	51		05.00	05.01	+ ABS/ - Entreprise				
	1.9 D Entreprise			10.00	05.01	+ ABS				
	2.0	89		05.97	05.01					
	2.0 16V			03.97	05.01					
	2.0 HDi	66		06.99	05.01					
	2.0 S16	110		05.97	05.01					
	2.0 S16	112		05.97	05.01					
	2.0 S16	110		03.94	04.97		G1020363		21674 19,0 +/Wl/S	LUC
	2.0 S16	112		07.94	04.97					
	2.0 S16	120		03.96	05.01					
		1.1	44		03.94	04.97	- ABS	G2110187		247 10,0 9,0 +S +C
1.4		55		03.93	04.97	- ABS				
1.4	55		05.97	05.01	- ABS	G2113185		248 13,0 11,0 +S +C		
	1.1	44		03.94	04.97	+ ABS	G2120132		247 20,4 18,5 V +S +C	
	1.4	55	ORGA 08575	03.93		+ ABS/ - Entreprise				
	1.4 Entreprise	55		03.93	05.01					
	1.6	65	ORGA 08575	03.93						
	1.6	65	ORGA 08576		10.00	- ABS				
	1.6	72		10.00	05.01	- ABS				
	1.8	74	ORGA 08575	03.93						
	1.8	74	ORGA 08576		05.01	- ABS				
	1.8 D	43		03.93	05.01					
	1.9 D	47		05.93	05.01					
	1.9 D	50		06.94	05.01					
	1.9 D	51	ORGA 08575	09.98						
	1.9 D	51		09.98	10.00	+ ABS				
	1.9 D	51	ORGA 08576		05.01	- ABS				
	1.9 D	55		03.98	05.01					
	1.9 TD	66		10.93	05.01					
	1.4	55	ORGA 08576		05.01	+ ABS	G2120133		266 20,5 18,5 V +S +C	
	1.6	65	ORGA 08576		10.00	+ ABS				
	1.6	72		10.00	05.01	+ ABS				
	1.8	74	ORGA 08576		05.01	+ ABS				
	1.8 16V	81		03.97	05.01					
	1.9 D	51	ORGA 08576		05.01	+ ABS/ - Entreprise				
	1.9 D Entreprise			10.00	05.01	+ ABS				
	2.0	89		03.94	05.01					
	2.0 16V			03.97	05.01					
	2.0 HDi	66		06.99	05.01					
	2.0 S16	110		05.97	05.01					
	2.0 S16	112		05.97	05.01					

**PEUGEOT 306 Saloon (4-door) (94-01)**

	1.4	55		10.94	04.97	- ABS	G1020295		20905 18,0 +/Wl	BDX
	1.4	55	ORGA 08575	10.94		+ ABS				
	1.6	65	ORGA 08575	10.94			G1020292		21430 17,3 +/Wl	ATE
	1.6	65	ORGA 08576		10.00	- ABS				
	1.6	72		10.00	05.01	- ABS	G1020293		21827 17,3 +	ATE
	1.8	74	ORGA 08575	04.94						



**PEUGEOT 306 Saloon (4-door) (94-01)**

	1.8	74	ORGA 08576		05.01	- ABS	G1020292 G1020293		21430 17,3 +/W/ 21827 17,3 +	ATE ATE			
	1.9 D	47			10.94	05.01							
	1.9 D	50			10.94	05.01							
	1.9 D	51	ORGA 08575		09.98								
	1.9 D	51	ORGA 08576			05.01 - ABS							
	1.9 D	55			03.98	05.01							
	1.9 TD	66			10.94	05.01							
	1.4	55	ORGA 08576			05.01 + ABS					G1020513 G1020451	23332 18,0 +/W/S 23124 19,0 +/W/S	BOS LUC
	1.6	65	ORGA 08576		10.00	+ ABS							
	1.6	72			10.00	+ ABS							
1.8	74	ORGA 08576		05.01	+ ABS								
1.8 16V	81			03.97	05.01								
1.9 D	51	ORGA 08576			+ ABS								
2.0	89			05.97	05.01								
2.0 16V	97			03.97	05.01								
2.0 HDi	66			06.99	05.01								
2.0 S16	110			05.97	05.01								
2.0 S16	112			05.97	05.01								
	1.4	55			10.94	04.97 - ABS	G2110187 G2113185 G2120132		247 10,0 9,0 +S +C 248 13,0 11,0 +S +C 247 20,4 18,5 V +S +C				
	1.4	55			05.97	05.01 - ABS							
	1.4	55	ORGA 08575		10.94	+ ABS							
	1.6	65	ORGA 08576		10.00	- ABS							
	1.6	65			10.94	05.00							
	1.6	72			10.00	05.01 - ABS							
	1.8	74	ORGA 08575		04.94								
	1.8	74	ORGA 08576			05.01 - ABS							
	1.9 D	47			10.94	05.01							
	1.9 D	50			10.94	05.01							
1.9 D	51	ORGA 08575		09.98									
1.9 D	51	ORGA 08576			05.01 - ABS								
1.9 D	55			03.98	05.01								
1.9 TD	66			10.94	05.01								
	1.4	55			05.00	05.01 + ABS	G2120133		266 20,5 18,5 V +S +C				
	1.6	65			05.00	10.00 + ABS							
	1.6	72			10.00	05.01 + ABS							
	1.8	74			05.00	05.01 + ABS							
	1.8 16V	81			03.97	05.01							
	1.9 D	51			05.00	05.01 + ABS							
	2.0	89			04.94	05.01							
	2.0 16V	97			03.97	05.01							
	2.0 HDi	66			06.99	05.01							
	2.0 S16	110			05.97	05.01							
2.0 S16	112			05.97	05.01								
	1.8 16V	81			03.97	05.01	G1020522		20974 10,7	BDX			
	2.0	89			04.94	05.01							
	2.0 16V	97			03.97	05.01							
	2.0 HDi	66			06.99	05.01							
	2.0 S16	110			06.94	05.01							
	2.0 S16	112			07.94	05.01							
	1.8 16V	81			03.97	05.01	G2108106		247 8,0 6,0 +S +C				
	2.0	89			04.94	05.01							
	2.0 16V	97			03.97	05.01							
	2.0 HDi	66			06.99	05.01							
	2.0 S16	110			06.94	05.01							
	2.0 S16	112			07.94	05.01							

**PEUGEOT 306 Convertible (94-03)**

	1.6	65	ORGA 08575	04.96			G1020292 G1020293		21430 17,3 +/W/ 21827 17,3 +	ATE ATE
	1.6	65		05.00	10.00	- ABS				
	1.8	74	ORGA 08575	03.94						
	1.8	74		05.00	10.00	- ABS				
	1.8 16V	81	ORGA 08575	07.00						
	1.8 16V	81		07.00	04.02	- ABS				
	1.6	65	ORGA 08576		10.00	+ ABS	G1020513 G1020451		23332 18,0 +/W/S 23124 19,0 +/W/S	BOS LUC
	1.6	72		10.00	07.03					
	1.8	74	ORGA 08576		10.00	+ ABS				
	1.8 16V	81		07.00	04.02					
	2.0	89		03.94	04.97					
	2.0 16V	97		03.97	10.00					
	1.6	65	ORGA 08575	04.96			G2120132		247 20,4 18,5 V +S +C	
	1.6	65	ORGA 08576		10.00	- ABS				
	1.8	74	ORGA 08575	03.94						
	1.8	74	ORGA 08576		10.00	- ABS				
	1.6	65	ORGA 08576		10.00	+ ABS	G2120133		266 20,5 18,5 V +S +C	
	1.6	72		10.00	07.03					
	1.8	74	ORGA 08576		10.00	+ ABS				
	1.8 16V	81		07.00	07.03					
	2.0	89		03.94	04.97					
	1.8 16V	81		07.00	07.03		G1020522		20974 10,7	BDX
	2.0	89		03.94	04.97					
	2.0 16V	97		03.97	10.00					



<b>PEUGEOT 306 Convertible (94-03)</b>																	
	1.8 16V 2.0 2.0 16V	81 89 97			07.00 03.94 03.97	07.03 04.97 10.00											247 8,0 6,0 +S +C
<b>PEUGEOT 306 Estate (97-02)</b>																	
	1.4 1.6 1.6 1.8 D 1.9 D	55 65 72 51			03.97 03.97 10.00 03.97 03.97	03.02 - ABS - ABS - ABS - ABS											21827 17,3 + ATE
	1.4 1.6 1.6 1.8 1.8 16V 1.8 D 1.9 D 1.9 TD 2.0 16V 2.0 HDi	55 65 72 74 81 66 66 97 66			03.97 03.97 10.00 03.97 03.97 03.97 03.97 03.97 03.97 06.99	03.02 + ABS + ABS + ABS + ABS + ABS + ABS + ABS + ABS + ABS											23332 18,0 +/W/S 23124 19,0 +/W/S BOS LUC
	1.4 1.6 1.6 1.8 D 1.9 D	55 65 72 51			03.97 03.97 10.00 03.97 03.97	03.02 - ABS - ABS - ABS - ABS											247 20,4 18,5 V +S +C
	1.4 1.6 1.6 1.8 1.8 16V 1.8 D 1.9 D 1.9 TD 2.0 16V 2.0 HDi	55 65 72 74 81 66 66 97 66			03.97 03.97 10.00 03.97 03.97 03.97 03.97 03.97 03.97 06.99	03.02 + ABS + ABS + ABS + ABS + ABS + ABS + ABS + ABS + ABS											266 20,5 18,5 V +S +C
	1.8 16V 2.0 16V 2.0 HDi	81 97 66			03.97 03.97 06.99	03.02 03.02 03.02											20974 10,7 BDX
	1.8 16V 2.0 16V 2.0 HDi	81 97 66			03.97 03.97 06.99	03.02 03.02 03.02											247 8,0 6,0 +S +C
<b>PEUGEOT 307 Saloon (00-07)</b>																	
	1.4 16V 1.6 16V 1.6 16V 1.6 HDi 110 1.6 HDi 90 2.0 16V 2.0 16V 2.0 HDi 110	65 80 80 80 66 100 103 79	ORGA 10550 ORGA 10550 ORGA 10550	11.03 08.00 08.00 02.04 04.05 08.00 03.05 08.00	+ ESP + ESP/ + manual transm. <sup>1)</sup> + autom.transmission <sup>2)</sup> + ESP												23600 19,4 /Acc/S BOS
	2.0 16V 2.0 HDi 135	130 100		06.05 10.03	07.07 07.07												23589 19,1 + ATE
	1.4 1.4 16V 1.4 16V 1.4 HDi 1.6 16V 1.6 16V 1.6 HDi 90 1.6 HDi 90 2.0 HDi 90	55 65 ORGA 10551 65 50 80 ORGA 10551 80 66 ORGA 10551 66 66		08.00 11.03 10.01 07.07 08.00 08.00 04.05 08.00	07.07 + ESP - ESP + ESP/ + manual transm. <sup>1)</sup> - ESP/ + manual transm. <sup>3)</sup> + ESP - ESP												266 22,0 20,0 V +S +C
	1.4 16V 1.6 16V 1.6 16V 1.6 HDi 110 1.6 HDi 90 2.0 16V 2.0 16V 2.0 HDi 110	65 80 80 80 66 100 103 79	ORGA 10550 ORGA 10550	11.03 08.00 08.00 02.04 04.05 08.00 03.05 08.00	+ ESP + autom.transmission <sup>2)</sup> + ESP/ + manual transm. <sup>1)</sup> + ESP												283 26,0 24,0 V +S +C
	1.4 1.4 16V 1.4 HDi 1.6 16V 1.6 HDi 110 1.6 HDi 90 2.0 16V 2.0 16V 2.0 16V 2.0 HDi 110 2.0 HDi 135 2.0 HDi 90	55 65 50 80 80 66 100 103 130 79 100 66		08.00 11.03 10.01 08.00 02.04 04.05 08.00 03.05 06.05 08.00 10.03 08.00	07.07 07.07 07.07 07.07 07.07 07.07 07.07 07.07 07.07 07.07 07.07 07.07												23554 17,1 /WD/S LUC
	1.4 1.4 16V 1.4 HDi	55 65 50	ORGA 10656 ORGA 10656 ORGA 10656	08.00 11.03 10.01													24150 17,6 /S BOS

1) + ESP/+ scatola cambio velocità / + ESP/ + transmission mécanique / + ESP/ + cambio de velocidad / + ESP/ + Schaltgetriebe

2) + scatola cambio automatico / + transmission automatique / + cambio automático / + Automatikgetriebe

3) - ESP/+ scatola cambio velocità / - ESP/ + transmission mécanique / - ESP/ + cambio de velocidad / - ESP/ + Schaltgetriebe



**PEUGEOT 307 Saloon (00-07)**

	1.6 16V	80	ORGA 10656	08.00		G1020630		24150 17,6 /S	BOS
	1.6 HDi 110	80	ORGA 10656	02.04					
	1.6 HDi 90	66	ORGA 10656	04.05					
	2.0 16V	100	ORGA 10656	08.00					
	2.0 16V	103	ORGA 10656	03.05					
	2.0 16V	130	ORGA 10656	06.05					
	2.0 HDi 110	79	ORGA 10656	08.00					
	2.0 HDi 135	100	ORGA 10656	10.03					
	2.0 HDi 90	66	ORGA 10656	08.00					
	1.4	55		08.00	07.07	G2109137		247 9,0 8,0 +S +C	
	1.4 16V	65		11.03	07.07				
	1.4 HDi	50		10.01	07.07				
	1.6 16V	80		08.00	07.07				
	1.6 HDi 110	80		02.04	07.07				
	1.6 HDi 90	66		04.05	07.07				
	2.0 16V	100		08.00	07.07				
	2.0 16V	103		03.05	07.07				
	2.0 16V	130		06.05	07.07				
	2.0 HDi 110	79		08.00	07.07				
	2.0 HDi 135	100		10.03	07.07				
	2.0 HDi 90	66		08.00	07.07				

**PEUGEOT 307 Estate (02-08)**

	1.4	55	ORGA 10550	04.02	+ ESP	G1020735		23600 19,4 /Acc/S	BOS
	1.4 16V	65	ORGA 10550	11.03	+ ESP				
	1.6 16V	80		03.02	04.08				
	1.6 BioFlex	80		09.07	04.08				
	1.6 HDi 110	80		02.04	04.08				
	1.6 HDi 90	66		04.05	04.08				
	2.0 16V	100		03.02	04.08				
	2.0 16V	103	ORGA 12053	03.05					
	2.0 HDi 110	79	ORGA 12053	03.02					
	2.0 HDi 90	66		03.02	04.08				
	2.0 16V	130		06.05	04.08	G1020745		23589 19,1 +	ATE
	2.0 HDi 135	100		02.04	04.08				
	1.4	55	ORGA 10551	04.02	04.08 + ESP	G2122194		266 22,0 20,0 V +S +C	
	1.4	55			09.03 - ESP				
	1.4 16V	65	ORGA 10551		04.08 + ESP				
	1.4 16V	65			11.03 04.08 - ESP				
	1.4 HDi	50			03.02 04.08 - ESP				
	1.4	55	ORGA 10550	04.02	+ ESP	G2126120		283 26,0 24,0 V +S +C	
	1.4 16V	65	ORGA 10550	11.03	+ ESP				
	1.6 16V	80		03.02	04.08				
	1.6 BioFlex	80		09.07	04.08				
	1.6 HDi 110	80		02.04	04.08				
	1.6 HDi 90	66		04.05	04.08				
	2.0 16V	100		03.02	04.08				
	2.0 16V	103		03.05	04.08				
	2.0 HDi 110	79		03.02	04.08				
	2.0 HDi 90	66		03.02	04.08				
		1.4	55	ORGA 12056	04.02				
1.4 16V		65	ORGA 12056	11.03					
1.4 HDi		50	ORGA 12056	03.02					
1.6 16V		80	ORGA 12056	03.02					
1.6 HDi 110		80	ORGA 12056	02.04					
1.6 HDi 90		66	ORGA 12056	04.05					
2.0 16V		100	ORGA 12056	03.02					
2.0 16V		103	ORGA 12056	03.05					
2.0 16V		130	ORGA 12056	06.05					
2.0 HDi 110		79	ORGA 12056	03.02					
2.0 HDi 135		100	ORGA 12056	02.04					
2.0 HDi 90		66	ORGA 12056	03.02					
		1.4	55	ORGA 10656	04.02		G1020630		24150 17,6 /S
	1.4 16V	65	ORGA 10656	11.03					
	1.4 HDi	50	ORGA 10656	03.02					
	1.6 16V	80	ORGA 10656	03.02					
	1.6 HDi 110	80	ORGA 10656	02.04					
	1.6 HDi 90	66	ORGA 10656	04.05					
	2.0 16V	100	ORGA 10656	03.02					
	2.0 16V	103	ORGA 10656	03.05					
	2.0 16V	130	ORGA 10656	06.05					
	2.0 HDi 110	79	ORGA 10656	03.02					
	2.0 HDi 135	100	ORGA 10656	02.04					
	2.0 HDi 90	66	ORGA 10656	03.02					
		1.4	55		04.02	04.08			
1.4 16V		65		03.02	04.08				
1.4 HDi		50		03.02	04.08				
1.6 16V		80		03.02	04.08				
1.6 HDi 110		80		02.04	04.08				
1.6 HDi 90		66		04.05	04.08				
2.0 16V		100		03.02	04.08				
2.0 16V		103		03.05	04.08				
2.0 16V		130		06.05	04.08				
2.0 HDi 110		79		03.02	04.08				
2.0 HDi 135		100		02.04	04.08				
2.0 HDi 90		66		03.02	04.08				



















**PEUGEOT 307 CC (03-09)**

	CC 110	80		03.05	02.09	G1020735		23600 19,4 /Acc/S	BOS
	CC 135	100		10.03	02.09				
	CC 140	103	ORGA 12053	03.05					
	CC 180	130		10.03	02.09				
	CC HDi 135	100		06.05	02.09				
	CC 110	80		03.05	02.09	G2126120		283 26,0 24,0 V +S +C	
	CC 135	100		10.03	02.09				
	CC 140	103		03.05	02.09				
	CC 110	80	ORGA 12056	03.05		G1020492		23554 17,1 /WD/S	LUC
	CC 135	100	ORGA 12056	10.03					
	CC 140	103	ORGA 12056	03.05					
	CC 180	130	ORGA 12056	10.03					
	CC HDi 135	100	ORGA 12056	06.05					
	CC 110	80	ORGA 10656	03.05		G1020630		24150 17,6 /S	BOS
	CC 135	100	ORGA 10656	10.03					
	CC 140	103	ORGA 10656	03.05					
	CC 180	130	ORGA 10656	10.03					
	CC HDi 135	100	ORGA 10656	06.05					
	CC 110	80		03.05	02.09	G2109137		247 9,0 8,0 +S +C	
	CC 135	100		10.03	02.09				
	CC 140	103		03.05	02.09				
	CC 180	130		10.03	02.09				
	CC HDi 135	100		06.05	02.09				

**PEUGEOT 307 SW (02-08)**

	1.4	55	ORGA 10550	04.02		G1020735		23600 19,4 /Acc/S	BOS	
	1.4 16V	65	ORGA 10550	11.03	+ ESP					
	1.6 16V	80		03.02	04.08					
	1.6 BioFlex	80		09.07	04.08					
	1.6 D	66		12.06	04.08					
	1.6 HDi 110	80		02.04	04.08					
	2.0 16V	100		03.02	04.08					
	2.0 16V	103	ORGA 12053	03.05						
	2.0 HDi 110	79	ORGA 12053	03.02						
	2.0 HDi 90	66		03.02	04.08					
	2.0 HDi 135	100		02.04	04.08	G1020745		23589 19,1 +	ATE	
		1.4	55	ORGA 10551		04.08	G2122194		266 22,0 20,0 V +S +C	
		1.4	55		04.02	04.08				
		1.4 16V	65	ORGA 10551		04.08				
		1.4 16V	65		11.03	04.08				
		1.4 HDi	50		03.02	01.05				
		1.4	55	ORGA 10550	04.02	+ ESP	G2126120		283 26,0 24,0 V +S +C	
		1.4 16V	65	ORGA 10550	11.03	+ ESP				
		1.6 16V	80		03.02	04.08				
		1.6 BioFlex	80		09.07	04.08				
1.6 D		66		12.06	04.08					
1.6 HDi 110		80		02.04	04.08					
2.0 16V		100		03.02	04.08					
2.0 16V		103		03.05	04.08					
2.0 HDi 110		79		03.02	04.08					
2.0 HDi 90		66		03.02	04.08					
	1.4	55	ORGA 12056	04.02		G1020492		23554 17,1 /WD/S	LUC	
	1.4 16V	65	ORGA 12056	11.03						
	1.4 HDi	50		03.02	01.05					
	1.6 16V	80	ORGA 12056	03.02						
	1.6 BioFlex	80	ORGA 12056	09.07						
	1.6 D	66	ORGA 12056	12.06						
	1.6 HDi 110	80	ORGA 12056	02.04						
	2.0 16V	100	ORGA 12056	03.02						
	2.0 16V	103	ORGA 12056	03.05						
	2.0 HDi 110	79	ORGA 12056	03.02						
	2.0 HDi 135	100	ORGA 12056	02.04		G1020630		24150 17,6 /S	BOS	
	2.0 HDi 90	66	ORGA 12056	03.02						
	1.4	55	ORGA 10656	04.02						
	1.4 16V	65	ORGA 10656	11.03						
	1.4 HDi	50		03.02	01.05					
	1.6 16V	80	ORGA 10656	03.02						
	1.6 BioFlex	80	ORGA 10656	09.07						
	1.6 D	66	ORGA 10656	12.06						
	1.6 HDi 110	80	ORGA 10656	02.04						
	2.0 16V	100	ORGA 10656	03.02						
	2.0 16V	103	ORGA 10656	03.05		G2109137		247 9,0 8,0 +S +C		
	2.0 HDi 110	79	ORGA 10656	03.02						
	2.0 HDi 135	100	ORGA 10656	02.04						
	2.0 HDi 90	66	ORGA 10656	03.02						
	1.4	55		04.02	04.08					
	1.4 16V	65		03.02	04.08					
	1.4 HDi	50		03.02	01.05					
	1.6 16V	80		03.02	04.08					
	1.6 BioFlex	80		09.07	04.08					
	1.6 D	66		12.06	04.08					
1.6 HDi 110	80		02.04	04.08						
2.0 16V	100		03.02	04.08						
2.0 16V	103		03.05	04.08						
2.0 HDi 110	79		03.02	04.08						
2.0 HDi 135	100		02.04	04.08						
2.0 HDi 90	66		03.02	04.08						

								
<b>PEUGEOT 307 SW (02-08)</b>								
	2.0 HDi 90	66		03.02	04.08		G2109137	247 9,0 8,0 +S +C
<b>PEUGEOT 308 Saloon (07-)</b>								
	1.4 16V	72		12.09			G1020859	24660 17,8 /Acc/S <b>BOS</b>
	1.4 VTi	70		08.07				
	1.6 140 THP	103		08.07				
	1.6 150 THP	110		08.07				
	1.6 16V	115		10.09				
	1.6 BioFlex	80		04.08				
	1.6 HDi 110	80		08.07				
	1.6 HDi 112	82		12.09				
	1.6 HDi 115	84		03.13				
	1.6 HDi 90	66		08.07				
	1.6 HDi 92	68		11.09				
	1.6 VTi	88		08.07				
	2.0 HDi 135	100	ORGA 11678					
	2.0 HDi FAP 140	103		12.08				
	1.6 16V	115		10.09			G1020745	23589 19,1 + <b>ATE</b>
	1.6 175 THP	128	ORGA 11678	03.08				
	2.0 HDi 135	100		08.07				
	2.0 HDi 163	120		04.12				
	1.4 16V	72		12.09			G2126120	283 26,0 24,0 V +S +C
	1.4 VTi	70		08.07				
	1.6 140 THP	103		08.07				
	1.6 150 THP	110		08.07				
	1.6 BioFlex	80		04.08				
	1.6 HDi 110	80		08.07				
	1.6 HDi 112	82		12.09				
	1.6 HDi 115	84		03.13				
	1.6 HDi 90	66		08.07				
	1.6 HDi 92	68		11.09				
	1.6 VTi	88		08.07				
	2.0 HDi 135	100	ORGA 11678					
	2.0 HDi 135	100		08.07				
	2.0 HDi FAP 140	103		12.08				
	1.4 16V	72		12.09			G1020920	23554 16,8 /WD/Acc/S <b>LUC</b>
	1.4 VTi	70		08.07				
	1.6 140 THP	103		08.07				
	1.6 150 THP	110		08.07				
	1.6 16V	115		10.09				
	1.6 175 THP	128		03.08				
	1.6 BioFlex	80		04.08				
	1.6 HDi 110	80		08.07				
	1.6 HDi 112	82		12.09				
	1.6 HDi 115	84		03.13				
	1.6 HDi 90	66		08.07				
	1.6 HDi 92	68		11.09				
	1.6 VTi	88		08.07				
	2.0 HDi 135	100		08.07				
	2.0 HDi 163	120		04.12				
	2.0 HDi FAP 140	103		12.08				
	1.6 GTi	147		07.10			G1020946	24922 17,5 /Acc/S <b>LUC</b>
<b>PEUGEOT 308 SW (08-)</b>								
	1.4 16V	70		05.08			G1020859	24660 17,8 /Acc/S <b>BOS</b>
	1.4 16V	72		12.09				
	1.6 16V	88		05.08				
	1.6 Bioflex	82		03.09				
	1.6 HDi 110	80		05.08				
	1.6 HDi 112	82		12.09				
	1.6 HDi 115	84		03.13				
	1.6 HDi 90	66		05.08				
	1.6 HDi 92	68		11.09				
	2.0 BioFlex	103	ORGA 11679					
	1.6 16V	103		05.08			G1020745	23589 19,1 + <b>ATE</b>
	1.6 16V	110		05.08				
	1.6 16V	115		10.09				
	1.6 16V	128		05.08				
	2.0 BioFlex	103	ORGA 11678	05.08				
	2.0 HDi	120		06.09				
	2.0 HDi 135	100		05.08				
	2.0 HDi 140	103		12.08				
	2.0 HDi 150	110		04.11				
	1.4 16V	70		05.08			G2126120	283 26,0 24,0 V +S +C
	1.4 16V	72		12.09				
	1.6 16V	88		05.08				
	1.6 Bioflex	82		03.09				
	1.6 HDi 110	80		05.08				
	1.6 HDi 112	82		12.09				
	1.6 HDi 115	84		03.13				
	1.6 HDi 90	66		05.08				
	1.6 HDi 92	68		11.09				
	2.0 BioFlex	103	ORGA 11679					



**PEUGEOT 308 SW (08-)**

	1.4 16V	70		05.08	- Break Loisirs	G1020920		23554 16,8 /WD/Acc/S	LUC				
	1.4 16V	72		12.09	- Break Loisirs								
	1.6 16V	88		05.08	- Break Loisirs								
	1.6 16V	103		05.08	- Break Loisirs								
	1.6 16V	110		05.08	- Break Loisirs								
	1.6 16V	115		10.09	- Break Loisirs								
	1.6 16V	128		05.08	- Break Loisirs								
	1.6 Bioflex	82		03.09	- Break Loisirs								
	1.6 HDi 110	80		05.08	- Break Loisirs								
	1.6 HDi 112	82		12.09	- Break Loisirs								
	1.6 HDi 115	84		03.13	- Break Loisirs								
	1.6 HDi 90	66		05.08	- Break Loisirs								
	1.6 HDi 92	68		11.09	- Break Loisirs								
	2.0 BioFlex	103		05.08	- Break Loisirs								
	2.0 HDi	120		06.09	- Break Loisirs								
	2.0 HDi 135	100		05.08	- Break Loisirs								
	2.0 HDi 140	103		12.08	- Break Loisirs								
	2.0 HDi 150	110		04.11	- Break Loisirs								
	1.4 16V	70		05.08	+ Break Loisirs					G1020921		24765 16,5 /Acc/S	LUC
	1.4 16V	72		12.09	+ Break Loisirs								
1.6 16V	88		05.08	+ Break Loisirs									
1.6 16V	103		05.08	+ Break Loisirs									
1.6 16V	110		05.08	+ Break Loisirs									
1.6 16V	115		10.09	+ Break Loisirs									
1.6 16V	128		05.08	+ Break Loisirs									
1.6 Bioflex	82		03.09	+ Break Loisirs									
1.6 HDi 110	80		05.08	+ Break Loisirs									
1.6 HDi 112	82		12.09	+ Break Loisirs									
1.6 HDi 115	84		03.13	+ Break Loisirs									
1.6 HDi 90	66		05.08	+ Break Loisirs									
1.6 HDi 92	68		11.09	+ Break Loisirs									
2.0 BioFlex	103		05.08	+ Break Loisirs									
2.0 HDi	120		06.09	+ Break Loisirs									
2.0 HDi 135	100		05.08	+ Break Loisirs									
2.0 HDi 140	103		12.08	+ Break Loisirs									
2.0 HDi 150	110		04.11	+ Break Loisirs									

**PEUGEOT 308 CC (09-)**

	1.6 16V	103		06.09		G1020745		23589 19,1 +	ATE
	1.6 16V	115		09.09					
	1.6 THP	110		06.09					
	2.0 HDi	100		04.09					
	2.0 HDi	120		06.09					
	2.0 HDi FAP 140	103		03.09					
	1.6 HDi	82		03.09		G1020859		24660 17,8 /Acc/S	BOS
	1.6 HDi 115	84		03.13					
	1.6 VTi	88		03.09					
	1.6 HDi	82		03.09		G2126120		283 26,0 24,0 V +S +C	
	1.6 HDi 115	84		03.13					
	1.6 VTi	88		03.09					
	1.6 16V	103		06.09		G1020920		23554 16,8 /WD/Acc/S	LUC
	1.6 16V	115		09.09					
	1.6 HDi	82		03.09					
	1.6 HDi 115	84		03.13					
	1.6 THP	110		06.09					
	1.6 VTi	88		03.09					
	2.0 HDi	100		04.09					
	2.0 HDi	120		06.09					
	2.0 HDi FAP 140	103		03.09					
	1.6 THP	147		10.10					

**PEUGEOT 309 (85-93)**

	1.1			09.85	12.93	G1020214		20905 18,0 +/WI	BDX	
	1.3	47		09.85	07.89					G1020213
	1.4			03.89	12.93					
	1.5			06.87	12.89					
	1.6			09.85	12.93					
	1.8 D	44		07.89	12.93					
	1.8 TD	57		07.89	12.93					
	1.9	72		03.86	12.93					
	1.9	75		10.85	07.89					
	1.9	80		07.88	12.93					
	1.9 D			06.86	12.93					
	1.6 GTi	76		11.85	09.88	G1020214		20905 18,0 +/WI	BDX	
	1.9 GTi	88		09.88	12.93					+ ⊕
	1.9 GTi	94		10.86	07.89					+ ⊕
	1.9 GTi	96		10.86	12.93					- ⊖
	1.9 GTi 16V			08.89	12.93					
	1.1			09.85	12.93	G2110187		247 10,0 9,0 +S +C		
	1.3	47		09.85	07.89					
	1.4			03.89	12.93					
	1.5			06.87	12.89					
	1.6			09.85	12.93					
	1.8 D	44		07.89	12.93					
	1.8 TD	57		07.89	12.93					
1.9	72		03.86	12.93						

<b>PEUGEOT 309 (85-93)</b>									
	1.9	75		10.85	07.89	G2110187			247 10,0 9,0 +S +C
	1.9	80		07.88	12.93				
	1.9 D			06.86	12.93				
	1.6 GTi	76		11.85	09.88	G2120132			247 20,4 18,5 V +S +C
	1.9 GTi	88		09.88	12.93 + ⊕				
	1.9 GTi	94		10.86	07.89 + ⊕				
	1.9 GTi	96		10.86	12.93 - ⊕				
	1.9 GTi 16V			08.89	12.93				
	1.9 GTi	88		09.88	12.93 + ⊕	G1020216			20973 11,0 + BDX
	1.9 GTi	94		10.86	07.89 + ⊕				
	1.9 GTi	96		10.86	12.93 - ⊕				
	1.9 GTi 16V			08.89	12.93				
<b>PEUGEOT 405 (93-95)</b>									
	1.4 i	55		09.92	10.95	G1020214			20905 18,0 +/Wl BDX
	1.6	65		09.92	10.95				
	1.8 i	74		09.92	10.95	G2120133			266 20,5 18,5 V +S +C
	1.9	93		09.92	12.93				
	1.9 D			09.92	10.95				
	1.9 TD	66		09.92	10.95				
	2.0 16V	144		09.92	10.95				
	2.0 i	89		09.92	10.95				
	2.0 i X4	89		09.92	10.95				
	2.0 i X4	89		09.92	10.95	G1020201			20961 15,2 /WD/Acc/S LUC
	2.0 T16 X4	144		07.93	10.95				
	2.0 i X4	89		09.92	10.95	G2110187			247 10,0 9,0 +S +C
	2.0 T16 X4	144		07.93	10.95				
<b>PEUGEOT 406 Saloon (95-04)</b>									
	1.6 i	65		10.95	04.04	G1020362			21724 19,3 +/Wl/S LUC
	1.8 16V	81		10.95	10.00				
	1.8 16V	85		10.00	04.04				
	1.8 i	66		05.97	04.04				
	1.9 D	55		10.96	04.04				
	1.9 TD	66		01.96	04.04	G1020363			21674 19,0 +/Wl/S LUC
	1.9 TD	68		01.96	04.04				
	2.0 16V	97		10.95	04.04				
	2.0 16V	99		01.99	08.00				
	2.0 16V	100		08.00	04.04				
	2.0 16V HPi	103		05.01	04.04				
	2.0 HDi 110	80		02.99	08.01				
	2.0 HDi 110 FAP	79		08.01	04.04				
	2.0 HDi 90	66		02.99	04.04				
	2.0 Turbo	108		04.96	04.04				
	2.1 TD	80		10.95	04.04				
	2.2 HDi	98		03.00	04.04				
	2.2 i	116		07.00	04.04				
	3.0 24V	140		10.96	04.04				
	3.0 V6	152		03.00	04.04				
	1.9 TD	66		01.96	04.04	G2126106			283 26,0 24,2 V +S +C
	1.9 TD	68		01.96	04.04				
	2.0 16V	97		10.95	04.04				
	2.0 16V	99		01.99	08.00				
	2.0 16V	100		08.00	04.04				
	2.0 16V HPi	103		05.01	04.04				
	2.0 HDi 110	80		02.99	08.01				
	2.0 HDi 110 FAP	79		08.01	04.04				
	2.0 HDi 90	66		02.99	04.04				
	2.0 Turbo	108		04.96	04.04				
	2.1 TD	80		10.95	04.04				
	2.2 HDi	98		03.00	04.04				
	2.2 i	116		07.00	04.04				
	3.0 24V	140		10.96	04.04				
	3.0 V6	152		03.00	04.04				
	1.8 16V	85	S 80012040	10.00		G1020373			21278 16,4 +/Wl ATE
	2.0 16V	97	S 80012040	10.95					
	2.0 16V	99		01.99	08.00				
	2.0 16V	100	S 80012040	08.00					
	2.0 16V HPi	103	S 80012040	05.01					
	2.0 HDi 110	80		02.99	08.01				
	2.0 HDi 110 FAP	79	S 80012040	08.01					
	2.0 HDi 90	66	S 80012040	02.99					
	2.0 Turbo	108	S 80012040	04.96					
	2.1 TD	80	S 80012040	10.95					
	2.2 HDi	98	S 80012040	03.00					
	2.2 i	116	S 80012040	07.00					
	3.0 24V	140	S 80012040	10.96					
	3.0 V6	152	S 80012040	03.00					
	1.8 16V	85	S 80012041		04.04	G1020487			21278 16,4 ATE
	2.0 16V	97	S 80012041		04.04				
	2.0 16V	100	S 80012041		04.04				
	2.0 16V HPi	103	S 80012041		04.04				
	2.0 HDi 110 FAP	79	S 80012041		04.04				





**PEUGEOT 406 Saloon (95-04)**

	2.0 HDi 90	66 S 80012041		04.04	G1020487		21278 16,4	ATE
	2.0 Turbo	108 S 80012041		04.04				
	2.1 TD	80 S 80012041		04.04				
	2.2 HDi	98 S 80012041		04.04				
	2.2 i	116 S 80012041		04.04				
	3.0 24V	140 S 80012041		04.04				
	3.0 V6	152 S 80012041		04.04				
	1.8 16V	85		10.00 04.04	G2110230		291 10,0 8,0 +C	
	2.0 16V	97		10.95 04.04				
	2.0 16V	99		01.99 08.00				
	2.0 16V	100		08.00 04.04				
	2.0 16V HPi	103		05.01 04.04				
	2.0 HDi 110	80		02.99 08.01				
	2.0 HDi 110 FAP	79		08.01 04.04				
	2.0 HDi 90	66		02.99 04.04				
	2.0 Turbo	108		04.96 04.04				
	2.1 TD	80		10.95 04.04				
	2.2 HDi	98		03.00 04.04				
	2.2 i	116		07.00 04.04				
	3.0 24V	140		10.96 04.04				
	3.0 V6	152		03.00 04.04				





















**PEUGEOT 406 Estate (96-04)**

	1.8	66		05.97 04.04	G1020362		21724 19,3 +/M/S	LUC				
	1.8 16V	81		10.95 10.00								
	1.8 16V	85		10.96 04.04								
	1.9 D	55		10.96 04.04								
	1.9 TD	66		10.95 04.04								
	2.0 16V	97		10.96 04.04	G1020363		21674 19,0 +/M/S	LUC				
	2.0 16V	99		01.99 10.00								
	2.0 16V	100		10.00 04.04								
	2.0 16V HPi	103		05.01 04.04								
	2.0 HDi 110	80		02.99 08.01								
	2.0 HDi 110 FAP	79		08.01 04.04								
	2.0 HDi 90	66		02.99 04.04								
	2.0 Turbo	108		10.96 04.04								
	2.1 TD	80		10.96 04.04								
	2.2	116		07.00 04.04								
	2.2 HDi	98		03.00 04.04								
	3.0 24V	140		10.96 04.04								
	3.0 V6	152		03.00 04.04								
		1.9 TD	66						10.95 04.04	G2126106		283 26,0 24,2 V +S +C
		2.0 16V	97						10.96 04.04			
2.0 16V		99		01.99 10.00								
2.0 16V		100		10.00 04.04								
2.0 16V HPi		103		05.01 04.04								
2.0 HDi 110		80		02.99 08.01								
2.0 HDi 110 FAP		79		08.01 04.04								
2.0 HDi 90		66		02.99 04.04								
2.0 Turbo		108		10.96 04.04								
2.1 TD		80		10.96 04.04								
2.2		116		07.00 04.04								
2.2 HDi		98		03.00 04.04								
3.0 24V		140		10.96 04.04								
3.0 V6		152		03.00 04.04								
		1.8 16V	85	S 80012040	10.00	G1020373		21278 16,4 +/M/I	ATE			
	2.0 16V	97	S 80012040	10.96								
	2.0 16V	99		01.99 10.00								
	2.0 16V	100	S 80012040	10.00								
	2.0 16V HPi	103	S 80012040	05.01								
	2.0 HDi 110	80		02.99 08.01								
	2.0 HDi 110 FAP	79	S 80012040	08.01								
	2.0 HDi 90	66	S 80012040	02.99								
	2.0 Turbo	108	S 80012040	10.96								
	2.1 TD	80	S 80012040	10.96								
	2.2	116	S 80012040	07.00								
	2.2 HDi	98	S 80012040	03.00								
	3.0 24V	140	S 80012040	10.96								
	3.0 V6	152	S 80012040	03.00								
		1.8 16V	85 S 80012041		04.04					G1020487		21278 16,4
2.0 16V		97 S 80012041		04.04								
2.0 16V		100 S 80012041		04.04								
2.0 16V HPi		103 S 80012041		04.04								
2.0 HDi 110 FAP		79 S 80012041		04.04								
2.0 HDi 90		66 S 80012041		04.04								
2.0 Turbo		108 S 80012041		04.04								
2.1 TD		80 S 80012041		04.04								
2.2		116 S 80012041		04.04								
2.2 HDi		98 S 80012041		04.04								
3.0 24V		140 S 80012041		04.04								
3.0 V6		152 S 80012041		04.04								
		1.8 16V	85		10.00 04.04	G2110230		291 10,0 8,0 +C				
		2.0 16V	97		10.96 04.04							
		2.0 16V	99		01.99 10.00							
	2.0 16V	100		10.00 04.04								
	2.0 16V HPi	103		05.01 04.04								
2.0 HDi 110	80		02.99 08.01									























PEUGEOT 406 Estate (96-04)									
	2.0 HDi 110 FAP	79		08.01	04.04		G2110230		291 10,0 8,0 +C
	2.0 HDi 90	66		02.99	04.04				
	2.0 Turbo	108		10.96	04.04				
	2.1 TD	80		10.96	04.04				
	2.2	116		07.00	04.04				
	2.2 HDi	98		03.00	04.04				
	3.0 24V	140		10.96	04.04				
	3.0 V6	152		03.00	04.04				
PEUGEOT 406 Coupe (97-05)									
	2.0 16V	97		03.97	09.05		G1020363		21674 19,0 +/W/S LUC
	2.0 16V	99		01.99	10.00				
	2.0 16V	100		10.00	09.05				
	2.2	116		03.02	09.05				
	2.2 HDi	98		06.02	09.05				
	2.0 16V	97		03.97	09.05		G2126106		283 26,0 24,2 V +S +C
	2.0 16V	99		01.99	10.00				
	2.0 16V	100		10.00	09.05				
	2.2	116		03.02	09.05				
	2.2 HDi	98		06.02	09.05				
	2.0 16V	97	S 80012040	03.97			G1020373		21278 16,4 +/W/A TE
	2.0 16V	99		01.99	10.00				
	2.0 16V	100	S 80012040	10.00					
	2.2	116	S 80012040	03.02					
	2.2 HDi	98	S 80012040	03.00					
	3.0 24V	140	S 80012040	03.97					
	3.0 V6	152	S 80012040	03.00					
	2.0 16V	97	S 80012041		09.05		G1020487		21278 16,4 TE
	2.0 16V	100	S 80012041		09.05				
	2.2	116	S 80012041		09.05				
	2.2 HDi	98	S 80012041		09.05				
	3.0 24V	140	S 80012041		09.05				
	3.0 V6	152	S 80012041		09.05				
	2.0 16V	97		03.97	09.05		G2110230		291 10,0 8,0 +C
	2.0 16V	99		01.99	10.00				
	2.0 16V	100		10.00	09.05				
	2.2	116		03.02	09.05				
	2.2 HDi	98		03.00	09.05				
	3.0 24V	140		03.97	09.05				
	3.0 V6	152		03.00	09.05				
PEUGEOT 407 Saloon / SW (04-11)									
	1.6 HDi 110	80		05.04	02.11		G1020761		23134 19,6 +/W/S LUC
	1.8 16V	85		05.04	02.11				
	1.8 16V	92		09.05	02.11				
	2.0 16V	100		05.04	02.11				
	2.0 16V	103		09.05	02.11				
	2.0 Bioflex	103		09.07	02.11				
	2.0 HDi 135	100	ORGA 11682	05.04					
	2.2 16V	116		05.04	02.11		G1020762		24133 18,6 +/W/Acc/S LUC
	2.2 16V	120		09.05	02.11				
	2.2 HDi	120		06.08	02.11				
	2.2 HDi 170	125		05.06	02.11				
	2.7 HDi	150		10.05	02.11				
	3.0 V6	155	ORGA 12410	05.04					
	2.0 HDi	110		10.10	02.11		G1020893		24332 18,3 +/W/A TE
	2.0 HDi	120		07.09	02.11				
	2.0 HDi 135	100	ORGA 11683		02.11				
	2.0 HDi 140	103		08.08	02.11				
	1.6 HDi 110	80		05.04	02.11		G1020660		24135 17,7 /S LUC
	1.8 16V	85		05.04	02.11				
	1.8 16V	92		09.05	02.11				
	2.0 16V	100		05.04	02.11				
	2.0 16V	103		09.05	02.11				
	2.0 Bioflex	103		09.07	02.11				
	2.0 HDi	110		02.10	02.11				
	2.0 HDi	120		07.09	02.11				
	2.0 HDi 135	100		05.04	02.11				
	2.0 HDi 140	103		08.08	02.11				
	2.2 16V	116		05.04	02.11				
	2.2 16V	120		09.05	02.11				
	2.2 HDi	120		06.08	02.11				
	2.2 HDi 170	125		05.06	02.11				
	2.7 HDi	150		10.05	02.11				
	3.0 V6	155		05.04	02.11				
	1.6 HDi 110	80		05.04	02.11		G2112162		290 12,0 10,0 +S +C
	1.8 16V	85		05.04	02.11				
	1.8 16V	92		09.05	02.11				
	2.0 16V	100		05.04	02.11				
	2.0 16V	103		09.05	02.11				
	2.0 Bioflex	103		09.07	02.11				
	2.0 HDi	110		02.10	02.11				
	2.0 HDi	120		07.09	02.11				
	2.0 HDi 135	100		05.04	02.11				
	2.0 HDi 140	103		08.08	02.11				
	2.2 16V	116		05.04	02.11				



								
<b>PEUGEOT 407 Saloon / SW (04-11)</b>								
	2.2 16V 2.2 HDi 2.2 HDi 170 2.7 HDi 3.0 V6	120 120 125 150 155		09.05 06.08 05.06 10.05 05.04	02.11 02.11 02.11 02.11 02.11		G2112162	290 12,0 10,0 +S +C
<b>PEUGEOT 407 Coupe (05-11)</b>								
	2.0 HDi 135 2.2 16V 2.7 HDi 3.0 V6	100 120 150 155	ORGA 12410	07.07 10.05 10.05 10.05	12.11 12.11 12.11 12.11		G1020762	24133 18,6 +/W/Acc/S LUC
	2.0 HDi 2.0 HDi 2.0 HDi 2.0 HDi 135 2.2 16V 2.7 HDi 3.0 HDi 3.0 V6	110 120 110 100 120 150 177 155		02.10 06.09 02.10 06.09 07.07 10.05 06.09 10.05	12.11 12.11 12.11 12.11 12.11 12.11 12.11 12.11		G1020893 G1020660	24332 18,3 +/W/Acc/S ATE 24135 17,7 /S LUC
	2.0 HDi 2.0 HDi 135 3.0 HDi	120 100 177		06.09 07.07 06.09	12.11 12.11 12.11		G2112162	290 12,0 10,0 +S +C
<b>PEUGEOT 508 (10-)</b>								
	1.6 HDi 1.6 HDi 1.6 THP 1.6 VTi 2.0 HDi 2.0 HDi 2.0 HDi AWC 2.2 HDi Hybrid4	82 84 115 88 103 120 120 150 147		11.10 02.12 11.10 11.10 11.10 11.10 11.10 11.10 06.12	+ br.disc diam. 283mm /+ br.disc thickness 26mm <sup>1)</sup> + br.disc diam. 283mm /+ br.disc thickness 26mm <sup>1)</sup> + br.disc diam. 283mm /+ br.disc thickness 26mm <sup>1)</sup> + br-disc diam. 283mm /+ br-disc thickness 26mm <sup>1)</sup> + br-disc diam. 283mm /+ br-disc thickness 26mm <sup>1)</sup> + br-disc diam. 283mm /+ br-disc thickness 26mm <sup>1)</sup> + br-disc diam. 283mm /+ br-disc thickness 26mm <sup>1)</sup> + br-disc diam. 283mm /+ br-disc thickness 26mm <sup>1)</sup> + br-disc diam. 283mm /+ br-disc thickness 26mm <sup>1)</sup>	G1201070	25222 17,3 +/W/Acc/S ATE	
	1.6 HDi 1.6 HDi 1.6 THP 1.6 VTi 2.0 HDi 2.0 HDi 2.0 HDi AWC 2.2 HDi Hybrid4	82 84 115 88 103 120 120 150 147		11.10 02.12 11.10 11.10 11.10 11.10 11.10 11.10 06.12	+ br-disc diam. 304mm /+ br-disc thickness 28mm <sup>2)</sup> + br-disc diam. 304mm /+ br-disc thickness 28mm <sup>2)</sup> + br-disc diam. 304mm /+ br-disc thickness 28mm <sup>2)</sup> + br-disc diam. 304mm /+ br-disc thickness 28mm <sup>2)</sup> + br-disc diam. 304mm /+ br-disc thickness 28mm <sup>2)</sup> + br-disc diam. 304mm /+ br-disc thickness 28mm <sup>2)</sup> + br-disc diam. 304mm /+ br-disc thickness 28mm <sup>2)</sup> + br-disc diam. 304mm /+ br-disc thickness 28mm <sup>2)</sup> + br-disc diam. 304mm /+ br-disc thickness 28mm <sup>2)</sup>	G1201073	24332 18,3 +/W/Acc/S ATE	
	1.6 HDi 1.6 HDi 1.6 THP 1.6 VTi 2.0 HDi 2.0 HDi 2.0 HDi AWC 2.2 HDi Hybrid4	82 84 115 88 103 120 120 150 147		11.10 02.12 11.10 11.10 11.10 11.10 11.10 11.10 06.12			G1201069	25218 16,6 + ATE
	2.2 HDi Hybrid4	150 147		11.10 06.12			G1202946 G2112162	24922 17,5 /Acc/S LUC + electric parking brake <sup>3)</sup> 290 12,0 10,0 +S +C
<b>PEUGEOT 508 SW (10-)</b>								
	1.6 HDi 1.6 HDi 1.6 THP 1.6 VTi 2.0 HDi 2.0 HDi 2.0 HDi RXH Hybrid 2.2 HDi	82 84 115 88 103 120 147 150		11.10 02.12 11.10 11.10 11.10 11.10 12.11 11.10	+ br-disc diam. 283mm /+ br-disc thickness 26mm <sup>1)</sup> + br-disc diam. 283mm /+ br-disc thickness 26mm <sup>1)</sup> + br-disc diam. 283mm /+ br-disc thickness 26mm <sup>1)</sup> + br-disc diam. 283mm /+ br-disc thickness 26mm <sup>1)</sup> + br-disc diam. 283mm /+ br-disc thickness 26mm <sup>1)</sup> + br-disc diam. 283mm /+ br-disc thickness 26mm <sup>1)</sup> + br-disc diam. 283mm /+ br-disc thickness 26mm <sup>1)</sup> + br-disc diam. 283mm /+ br-disc thickness 26mm <sup>1)</sup>	G1201070	25222 17,3 +/W/Acc/S ATE	
	1.6 HDi 1.6 HDi 1.6 THP 1.6 VTi 2.0 HDi 2.0 HDi 2.0 HDi RXH Hybrid 2.2 HDi	82 84 115 88 103 120 147 150		11.10 02.12 11.10 11.10 11.10 11.10 12.11 11.10	+ br-disc diam. 304mm /+ br-disc thickness 28mm <sup>2)</sup> + br-disc diam. 304mm /+ br-disc thickness 28mm <sup>2)</sup> + br-disc diam. 304mm /+ br-disc thickness 28mm <sup>2)</sup> + br-disc diam. 304mm /+ br-disc thickness 28mm <sup>2)</sup> + br-disc diam. 304mm /+ br-disc thickness 28mm <sup>2)</sup> + br-disc diam. 304mm /+ br-disc thickness 28mm <sup>2)</sup> + br-disc diam. 304mm /+ br-disc thickness 28mm <sup>2)</sup> + br-disc diam. 304mm /+ br-disc thickness 28mm <sup>2)</sup>	G1201073	24332 18,3 +/W/Acc/S ATE	
	1.6 HDi 1.6 HDi 1.6 THP 1.6 VTi 2.0 HDi 2.0 HDi 2.2 HDi 2.0 HDi RXH Hybrid	82 84 115 88 103 120 150 147		11.10 02.12 11.10 11.10 11.10 11.10 11.10 12.11			G1201069 G1202946	25218 16,6 + ATE electric parking brake <sup>4)</sup> 24922 17,5 /Acc/S LUC
	2.2 HDi 2.0 HDi RXH Hybrid	150 147		11.10 12.11			G2112162 G2112162	+ electric parking brake <sup>3)</sup> 290 12,0 10,0 +S +C + electric parking brake <sup>3)</sup> 290 12,0 10,0 +S +C

1) + disco fr.diam. 283mm /+ disco fr.spessore 26mm / + disques fr.diam. 283mm /+ disques fr.épaisseur 26mm / + disco fr.diam. 283mm /+ disco fr.espesor 26mm / + Bremsscheibendurchm. 283 mm / + Bremsscheibendicke 26 mm  
2) + disco fr.diam. 304mm /+ disco fr.spessore 28mm / + disques fr.diam. 304mm /+ disques fr.épaisseur 28mm / + disco fr.diam. 304mm /+ disco fr.espesor 28mm / + Bremsscheibendurchm. 304 mm / + Bremsscheibendicke 28 mm  
3) + freno a mano elettrico / + frein à main électrique / + freno de mano eléctrico / + elektrische Feststellbremse  
4) fr.di stazionamento elettrico / frein à main électrique / freno de mano eléctrico / elektrische Feststellbremse

								
<b>PEUGEOT 607 (00-10)</b>								
	2.0 2.0 HDi 2.0 HDi 2.2 16V 2.2 16V 2.2 HDi 2.2 HDi 2.7 HDi 24V 3.0 V6 24V	100 80 100 116 120 98 125 150 155		12.04 12.04 09.05 12.04 09.05 12.04 05.06 12.04 03.04	12.10 12.10 12.10 12.10 12.10 12.10 12.10 12.10 12.10	G1020762		24133 18,6 +/W/Acc/S LUC
	2.0 2.0 HDi 2.0 HDi 2.2 16V 2.2 HDi 3.0 V6 24V	100 79 80 116 98 152		02.00 03.01 05.00 02.00 02.00 02.00	11.04 07.04 11.04 11.04 11.04 11.04	G1020487		21278 16,4 ATE
	2.0 2.0 HDi 2.0 HDi 2.2 16V 2.2 16V 2.2 HDi 2.2 HDi 2.7 HDi 24V 3.0 V6 24V	100 80 100 116 120 98 125 150 155		12.04 12.04 09.05 12.04 09.05 12.04 05.06 12.04 03.04	12.10 12.10 12.10 12.10 12.10 12.10 12.10 12.10 12.10	G1020660		24135 17,7 /S LUC
	2.0 2.0 HDi 2.0 HDi 2.2 16V 2.2 16V 2.2 HDi 2.2 HDi 2.7 HDi 24V 3.0 V6 24V	100 80 100 116 120 98 125 150 155		12.04 12.04 09.05 12.04 09.05 12.04 05.06 12.04 03.04	12.10 12.10 12.10 12.10 12.10 12.10 12.10 12.10 12.10	G2112162		290 12,0 10,0 +S +C
<b>PEUGEOT 806 (94-02)</b>								
	1.8 i 1.9 TD 2.0 16V 2.0 HDi 2.0 i 2.0 Turbo 2.1 TD	73  80 89 108 80		10.96 07.95 10.98 08.99 08.94 08.94 06.96	06.02 06.02 06.02 06.02 06.02 06.02 06.02	G1020350 G1020310		23042 19,0 /W/Acc BDX 21801 19,0 +/W/S LUC
	1.8 i	73		10.96	06.02	G2120155		258 20,0 18,2 V L +C
	1.8 i 1.9 TD 2.0 16V 2.0 HDi 2.0 i 2.0 Turbo 2.1 TD	73  80 89 108 80		10.96 07.95 10.98 08.99 08.94 08.94 06.96	06.02 + ABS 06.02 + ABS 06.02 06.02 + ABS 06.02 + ABS 06.02 06.02	G1020291		21275 17,0 +/W ATE
<b>PEUGEOT 807 (02-)</b>								
	2.0 16V 2.0 16V 2.0 HDi 2.0 HDi 2.0 HDi 2.0 HDi 2.2 16V 2.2 HDi	100 103 79 80 88 100 116 94		06.02 09.05 06.02 04.04 11.06 06.06 06.02 06.02	05.06	G1020514		20261 19,0 +/W/S LUC
	2.0 16V 2.0 16V 2.0 HDi 2.0 HDi 2.0 HDi 2.0 HDi 2.2 16V 2.2 HDi 2.2 HDi 3.0 V6	100 103 79 80 88 100 120 116 94 125 150		06.02 09.05 06.02 04.04 11.06 06.06 06.09 06.02 06.02 10.07 06.02	05.06	G1020549		20961 17,1 /W/S LUC
<b>PEUGEOT 1007 (05-11)</b>								
	1.6 HDi 110	80		04.07	02.11	G1020735		23600 19,4 /Acc/S BOS
	1.4 1.4 16V 1.4 HDi 1.6 16V 1.6 HDi 110	54 65 50 80 80		04.05 10.05 04.05 04.05 04.07	02.11 02.11 02.11 02.11 02.11	G2122194 G2126120		266 22,0 20,0 V +S +C 283 26,0 24,0 V +S +C

								
<b>PEUGEOT 1007 (05-11)</b>								
	1.6 16V 1.6 HDi 110	80 80		04.05 04.07	02.11 02.11		G1020492	23554 17,1 /WD/S LUC
	1.6 16V 1.6 HDi 110	80 80		04.05 04.07	02.11 02.11		G2109137	247 9,0 8,0 +S +C
<b>PEUGEOT 2008 (13-)</b>								
	1.2 VTi 82 1.4 HDi 68 1.6 e-HDi 115 1.6 e-HDi 92 1.6 VTi 120	60 50 84 68 88		03.13 03.13 03.13 03.13 03.13			G2122194 G2126120	266 22,0 20,0 V +S +C 283 26,0 24,0 V +S +C
	1.2 VTi 82 1.4 HDi 68 1.6 e-HDi 115 1.6 e-HDi 92 1.6 VTi 120	60 50 84 68 88		03.13 03.13 03.13 03.13 03.13			G1020920	23554 16,8 /WD/Acc/S LUC
<b>PEUGEOT 3008 (09-)</b>								
	1.6 HDi 1.6 HDi 1.6 VTi	80 82 88		06.09 08.10 06.09			G1020859	24660 17,8 /Acc/S BOS
	1.6 THP 2.0 HDi 2.0 HDi			06.09 06.09 09.11			G1020745	23589 19,1 + ATE
	2.0 Hybrid4	100 120		02.11			G1020792	24557 19,4 + ATE
	1.6 HDi 1.6 HDi 1.6 HDi 115 1.6 VTi	80 82 84 88		06.09 08.10 11.12 06.09			G2126120	283 26,0 24,0 V +S +C
	1.6 HDi 1.6 HDi 1.6 HDi 115 1.6 THP 1.6 VTi 2.0 HDi 2.0 Hybrid4	80 82 84 88 88 120		06.09 08.10 11.12 06.09 06.09 06.09 02.11			G1020946	24922 17,5 /Acc/S LUC
<b>PEUGEOT 4007 (07-12)</b>								
	2.0 2.0 4x4 2.2 HDi 4x4 2.4 16V 4x4	108 108 115 125		11.10 11.10 02.07 07.07	11.12 11.12 11.12 11.12		G1205230	23582 16,0 +
<b>PEUGEOT 4008 (12-)</b>								
	1.6 2.0	85 113		04.12 04.12			G1205241	23584 16,4 /MI AKE
	1.6 HDi AWC 1.8 HDi AWC	84 110		04.12 04.12			G1205241	23584 16,4 /MI AKE
	1.6 1.6 HDi AWC 1.8 HDi AWC 2.0	85 84 110 113	ORGA 13114 ORGA 13114 ORGA 13114 ORGA 13114	04.12 04.12 04.12 04.12			G1205230	23582 16,0 +
<b>PEUGEOT 5008 (09-)</b>								
	1.6 16V 1.6 HDi 1.6 HDi 1.6 HDi 115	88 80 82 84		09.09 09.09 08.10 11.12			G1020790	24538 18,5 + ATE
	1.6 16V 2.0 HDi 2.0 HDi 2.0 HDi	115 100 110 120		09.09 02.12 09.09 09.09			G1020792	24557 19,4 + ATE
	1.6 16V 1.6 HDi 1.6 HDi 1.6 HDi 115	88 80 82 84		09.09 09.09 08.10 11.12			G2126120	283 26,0 24,0 V +S +C
	1.6 16V 1.6 16V 1.6 HDi 1.6 HDi 1.6 HDi 115 2.0 HDi 2.0 HDi 2.0 HDi	88 115 80 82 84 100 110 120		09.09 09.09 09.09 08.10 11.12 02.12 09.09 09.09			G1020946	24922 17,5 /Acc/S LUC
<b>PEUGEOT BIPPER (08-)</b>								
	1.4 HDi 1.4 i 1.3 HDi 75	50 54 55		02.08 02.08 10.10			G1020740	23706 18,0 +/MI/S BOS
	1.4 HDi 1.3 HDi 75	50 55		02.08 10.10		+ autom.manual transmission <sup>1)</sup>	G2122147	23706 18,0 +/MI/Acc/S BOS
	1.4 HDi 1.3 HDi 75 1.4 HDi 1.4 i	50 55 50 54		02.08 10.10 02.08 02.08		+ manual transmission <sup>2)</sup>	G2122197	284 22,0 20,2 V +C 258 22,0 20,2 V +C

<sup>1)</sup> + scatola camb.velocità autom. / + transm.mécanique autom. / + cambio de velocidad autom. / + automatisiertes Schaltgetriebe

<sup>2)</sup> + scatola cambio velocità / + transmission mécanique / + cambio de velocidad / + Schaltgetriebe



**PEUGEOT BOXER Bus (94-02)**

	1.9 D (10)	51		02.94	12.99	G1020301		21797 19,7 +/W/S	LUC
	1.9 TD (10/14)	66		08.94	12.99				
	1.9 TD (10/14)	68		02.94	12.99				
	2.0 i (10/14)	80		02.94	12.99				
	2.5 D (14)	63		08.94	12.99				
	2.5 TD (14)	76		08.94	12.99				
	2.5 TDi (14)	79		01.97	12.99				
	1.9 D (10)	51		01.00	10.01				
1.9 TD (10/14)	66		01.00	10.01	G1020482		23602 19,7 +/W/S	LUC	
1.9 TD (10/14)	68		01.00	10.01					
2.0 i (10/14)	80		01.00	10.01					
2.5 D (14)	63		01.00	10.01					
2.5 TD (14)	76		01.00	10.01					
2.5 TDi (14)	79		01.00	10.01					
2.8 HDi (14)	94		11.00	10.01					
1.9 D (10)	51		11.01	03.02					G1020516
1.9 TD (10/14)	66		11.01	03.02					
1.9 TD (10/14)	68		11.01	03.02					
2.0 i (10/14)	80		11.01	03.02					
2.5 D (14)	63		11.01	03.02					
2.5 TD (14)	76		11.01	03.02					
2.5 TDi (14)	79		11.01	03.02					
2.8 HDi (14)	94		11.01	03.02					
2.0 i (18)	80		02.94	12.99	G1020302		21799 19,7 +/W/S	LUC	
2.5 D (18)	63		08.94	12.99					
2.5 TD (18)	76		08.94	12.99					
2.5 TDi (18)	79		01.97	12.99					
2.0 i (18)	80		01.00	10.01	G1020483		23603 19,7 +/W/S	LUC	
2.5 D (18)	63		01.00	10.01					
2.5 TD (18)	76		01.00	10.01					
2.5 TDi (18)	79		01.00	10.01					
2.8 HDi (18)	94		11.00	10.01	G1020517		23919 19,3 +/W/Acc	BRE	
2.0 i (18)	80		11.01	03.02					
2.5 D (18)	63		11.01	03.02					
2.5 TD (18)	76		11.01	03.02					
2.5 TDi (18)	79		11.01	03.02	G2124127		280 24,0 21,9 V +C		
2.8 HDi (18)	94		11.01	03.02					
2.5 TD (14)	76		08.94	03.02					
2.5 TDi (14)	79		01.97	03.02					
2.8 HDi (14)	94		11.00	03.02	G2124138		300 24,0 21,9 V +C		
2.0 i (18)	80		02.94	03.02					
2.5 D (18)	63		08.94	03.02					
2.5 TD (18)	76		08.94	03.02					
2.5 TDi (18)	79		01.97	03.02	G1020518		23921 20,3 /Acc	BRE	
1.9 D (10)	51		11.01	03.02					
1.9 TD (10/14)	66		11.01	03.02					
1.9 TD (10/14)	68		11.01	03.02					
2.0 i (10/14/18)	80		11.01	03.02					
2.5 D (14/18)	63		11.01	03.02					
2.5 TD (14/18)	76		11.01	03.02					
2.5 TDi (14/18)	79		11.01	03.02					
2.8 HDi (14/18)	94		11.01	03.02					
	1.9 D (10)	51		11.01	03.02	G2116124		280 16,0 14,2 +C	
	1.9 TD (10/14)	66		11.01	03.02				
	1.9 TD (10/14)	68		11.01	03.02				
	2.0 i (10/14)	80		11.01	03.02				
	2.5 D (14)	63		11.01	03.02				
	2.5 TD (14)	76		11.01	03.02				
	2.5 TDi (14)	79		11.01	03.02				
	2.8 HDi (14)	94		11.01	03.02				

**PEUGEOT BOXER Van (94-02)**

	1.9 D (10)	50		07.99	12.99	G1020301		21797 19,7 +/W/S	LUC
	1.9 D (10)	51		02.94	12.99				
	1.9 TD (10/14)	66		07.99	12.99				
	1.9 TD (10/14)	68		02.94	12.99				
	2.0 i (10/14)	80		02.94	12.99				
	2.5 D (14)	63		02.94	12.99				
	2.5 TD (14)	76		02.94	12.99				
	2.5 TDi (14)	79		01.97	12.99				
1.9 D (10)	50		01.00	10.01	G1020482		23602 19,7 +/W/S	LUC	
1.9 D (10)	51		01.00	10.01					
1.9 TD (10/14)	66		01.00	10.01					
1.9 TD (10/14)	68		01.00	10.01					
2.0 HDi (10/14)	62		08.01	10.01					
2.0 i (10/14)	80		01.00	10.01					
2.5 D (14)	63		01.00	10.01					
2.5 TD (14)	76		01.00	10.01					
2.5 TDi (14)	79		01.00	10.01	G1020516		23917 19,3 +/W/Acc	BRE	
2.8 HDi (14)	94		11.00	10.01					
1.9 D (10)	50		11.01	03.02					
1.9 D (10)	51		11.01	03.02					
1.9 TD (10/14)	66		11.01	03.02	G1020516		23917 19,3 +/W/Acc	BRE	
1.9 TD (10/14)	68		11.01	03.02					
2.0 HDi (10/14)	62		11.01	03.02					
2.0 i (10/14)	80		11.01	03.02	G1020516		23917 19,3 +/W/Acc	BRE	
2.0 i (10/14)	80		11.01	03.02					





**PEUGEOT BOXER Van (94-02)**

	2.5 D (14)	63		11.01	03.02	G1020516		23917 19,3 +/W/Acc	BRE
	2.5 TD (14)	76		11.01	03.02				
	2.5 TDi (14)	79		11.01	03.02				
	2.8 HDi (14)	94		11.01	03.02				
	2.0 i (18)	80		02.94	12.99				
	2.5 D (18)	63		02.94	12.99	G1020302		21799 19,7 +/W/S	LUC
	2.5 TD (18)	76		02.94	12.99				
	2.5 TDi (18)	79		01.97	12.99				
	2.0 i (18)	80		01.00	10.01				
	2.5 D (18)	63		01.00	10.01				
	2.5 TD (18)	76		01.00	10.01	G1020483		23603 19,7 +/W/S	LUC
	2.5 TDi (18)	79		01.00	10.01				
	2.8 HDi (18)	94		11.00	10.01				
	2.0 i (18)	80		11.01	03.02				
	2.5 D (18)	63		11.01	03.02				
	2.5 TD (18)	76		11.01	03.02	G1020517		23919 19,3 +/W/Acc	BRE
	2.5 TDi (18)	79		11.01	03.02				
	2.8 HDi (18)	94		11.01	03.02				
	2.5 TD (14)	76		02.94	03.02				
	2.5 TDi (14)	79		01.97	03.02				
	2.8 HDi (14)	94		11.00	03.02	G2124127		280 24,0 21,9 V +C	
	2.0 HDi (18)	62		08.01	03.02				
	2.0 i (18)	80		02.94	03.02				
	2.5 D (18)	63		02.94	03.02				
	2.5 TD (18)	76		02.94	03.02				
	2.5 TDi (18)	79		01.97	03.02	G2124138		300 24,0 21,9 V +C	
	2.8 HDi (18)	94		11.00	03.02				
	1.9 D (10)	50		11.01	03.02				
	1.9 D (10)	51		11.01	03.02				
	1.9 TD (10/14)	66		11.01	03.02				
	1.9 TD (10/14)	68		11.01	03.02	G1020518		23921 20,3 /Acc	BRE
	2.0 HDi (10/14/18)	62		11.01	03.02				
	2.0 i (10/14/18)	80		11.01	03.02				
	2.5 D (14/18)	63		11.01	03.02				
	2.5 TDi (14/18)	79		11.01	03.02				
	2.5 TDi (14/18)	79		11.01	03.02	G2116124		280 16,0 14,2 +C	
	2.8 HDi (14/18)	94		11.01	03.02				
	1.9 D (10)	50		11.01	03.02				
	1.9 D (10)	51		11.01	03.02				
	1.9 TD (10/14)	66		11.01	03.02				
	1.9 TD (10/14)	68		11.01	03.02	G1020518		280 16,0 14,2 +C	
	2.0 HDi (10/14)	62		11.01	03.02				
	2.0 i (10/14)	80		11.01	03.02				
	2.5 D (14)	63		11.01	03.02				
	2.5 TD (14)	76		11.01	03.02				
	2.5 TDi (14)	79		11.01	03.02	G2116124		280 16,0 14,2 +C	
	2.8 HDi (14)	94		11.01	03.02				

**PEUGEOT BOXER Pickup/Chassis (94-02)**

	1.9 TD (10/14)	66		12.98	12.99	G1020301		21797 19,7 +/W/S	LUC
	1.9 TD (10/14)	68		07.96	12.99				
	2.0 i (10/14)	80		06.94	12.99				
	2.5 D (14)	63		02.94	12.99				
	2.5 TD (14)	76		02.94	12.99				
	2.5 TDi (14)	79		01.97	12.99	G1020482		23602 19,7 +/W/S	LUC
	1.9 TD (10/14)	66		01.00	10.01				
	1.9 TD (10/14)	68		01.00	10.01				
	2.0 i (10/14)	80		01.00	10.01				
	2.5 D (14)	63		01.00	10.01				
	2.5 TD (14)	76		01.00	10.01	G1020516		23917 19,3 +/W/Acc	BRE
	2.5 TDi (14)	79		01.00	10.01				
	2.8 HDi (14)	94		11.00	10.01				
	1.9 TD (10/14)	66		11.01	03.02				
	1.9 TD (10/14)	68		11.01	03.02				
	2.0 i (10/14)	80		11.01	03.02	G1020302		21799 19,7 +/W/S	LUC
	2.5 D (14)	63		11.01	03.02				
	2.5 TD (14)	76		11.01	03.02				
	2.5 TDi (14)	79		11.01	03.02				
	2.8 HDi (14)	94		11.01	03.02				
	2.0 i (18)	80		06.94	12.99	G1020483		23603 19,7 +/W/S	LUC
	2.5 D (18)	63		02.94	12.99				
	2.5 TD (18)	76		02.94	12.99				
	2.5 TDi (18)	79		01.97	12.99				
	2.0 i (18)	80		01.00	10.01				
	2.5 D (18)	63		01.00	10.01	G1020517		23919 19,3 +/W/Acc	BRE
	2.5 TD (18)	76		01.00	10.01				
	2.5 TDi (18)	79		01.00	10.01				
	2.8 HDi (18)	94		11.00	10.01				
	2.0 i (18)	80		11.01	03.02				
	2.5 D (18)	63		11.01	03.02	G1020517		23919 19,3 +/W/Acc	BRE
	2.5 TD (18)	76		11.01	03.02				
	2.5 TDi (18)	79		11.01	03.02				
	2.8 HDi (18)	94		11.01	03.02				
	2.0 i (18)	80		11.01	03.02				



**PEUGEOT BOXER Pickup/Chassis (94-02)**

	2.5 TD (14)	76		02.94	03.02	G2124127		280 24,0 21,9 V +C				
	2.5 TDi (14)	79		01.97	03.02							
	2.8 HDi (14)	94		11.00	03.02							
	2.0 i (18)	80		06.94	03.02							
	2.5 D (18)	63		02.94	03.02	G2124138		300 24,0 21,9 V +C				
	2.5 TD (18)	76		02.94	03.02							
	2.5 TDi (18)	79		01.97	03.02							
	2.8 HDi (18)	94		11.00	03.02							
		1.9 TD (10/14)	66		11.01				03.02	G1020518		23921 20,3 /Acc <b>BRE</b>
		1.9 TD (10/14)	68		11.01				03.02			
2.0 i (10/14/18)		80		11.01	03.02							
2.5 D (14/18)		63		11.01	03.02							
2.5 TD (14/18)		76		11.01	03.02							
2.5 TDi (14/18)		79		11.01	03.02							
2.8 HDi (14/18)		94		11.01	03.02							
	1.9 TD (10/14)	66		11.01	03.02	G2116124		280 16,0 14,2 +C				
	1.9 TD (10/14)	68		11.01	03.02							
	2.0 i (10/14)	80		11.01	03.02							
	2.5 D (14)	63		11.01	03.02							
	2.5 TD (14)	76		11.01	03.02							
	2.5 TDi (14)	79		11.01	03.02							
	2.8 HDi (14)	94		11.01	03.02							

**PEUGEOT BOXER (02-06)**

	2.0 HDi (10/14)	62		04.02	03.06	G1020516		23917 19,3 +/W/Acc <b>BRE</b>
	2.0 i (10/14)	81		04.02	03.06			
	2.2 HDi (10/14)	74		04.02	03.06			
	2.8 HDi (10/14)	94		04.02	03.06			
	2.0 HDi (18)	62		04.02	03.06	G1020517		23919 19,3 +/W/Acc <b>BRE</b>
	2.0 i (18)	81		04.02	03.06			
	2.2 HDi (18)	74		04.02	03.06			
	2.8 HDi (18)	94		04.02	03.06			
	2.0 HDi (10/14)	62		04.02	03.06	G2124127		280 24,0 21,9 V +C
	2.0 i (10/14)	81		04.02	03.06			
	2.2 HDi (10/14)	74		04.02	03.06			
	2.8 HDi (10/14)	94		04.02	03.06			
	2.0 HDi (18)	62		04.02	03.06	G2124138		300 24,0 21,9 V +C
	2.0 i (18)	81		04.02	03.06			
	2.2 HDi (18)	74		04.02	03.06			
	2.8 HDi (18)	94		04.02	03.06			
	2.0 HDi (10/14/18)	62		04.02	03.06	G1020518		23921 20,3 /Acc <b>BRE</b>
	2.0 i (10/14/18)	81		04.02	03.06			
	2.2 HDi (10/14/18)	74		04.02	03.06			
	2.8 HDi (10/14/18)	94		04.02	03.06			
	2.0 HDi (10/14)	62		04.02	03.06	G2116124		280 16,0 14,2 +C
	2.0 i (10/14)	81		04.02	03.06			
	2.2 HDi (10/14)	74		04.02	03.06			
	2.8 HDi (10/14)	94		04.02	03.06			

**PEUGEOT BOXER (06-)**

	2.2 HDi 100	74		04.06	payload 120/140 <sup>1)</sup>	G1020763		24468 19,1 +/W/Acc <b>BRE</b>
	2.2 HDi 110	81		03.11	payload 120/140 <sup>1)</sup>			
	2.2 HDi 120	88		04.06	payload 120/140 <sup>1)</sup>			
	2.2 HDi 130	96		03.11	payload 120/140 <sup>1)</sup>			
	2.2 HDi 150	110		03.11	payload 120/140 <sup>1)</sup>			
	3.0 HDi 145	107		04.10	payload 120/140 <sup>1)</sup>			
	3.0 HDi 160	116		04.06	payload 120/140 <sup>1)</sup>			
	3.0 HDi 175	130		03.11	payload 120/140 <sup>1)</sup>			
		2.2 HDi 100	74		04.06			
2.2 HDi 110		81		03.11	light payload 160 <sup>2)</sup>			
2.2 HDi 120		88		04.06	light payload 160 <sup>2)</sup>			
2.2 HDi 130		96		03.11	light payload 160 <sup>2)</sup>			
2.2 HDi 150		110		03.11	light payload 160 <sup>2)</sup>			
3.0 HDi 145		107		04.10	light payload 160 <sup>2)</sup>			
3.0 HDi 160		116		04.06	light payload 160 <sup>2)</sup>			
3.0 HDi 175		130		03.11	light payload 160 <sup>2)</sup>			
		2.2 HDi 100	74		04.06	heavy payload 160 <sup>3)</sup>	G1020764	
	2.2 HDi 110	81		03.11	heavy payload 160 <sup>3)</sup>			
	2.2 HDi 120	88		04.06	heavy payload 160 <sup>3)</sup>			
	2.2 HDi 130	96		03.11	heavy payload 160 <sup>3)</sup>			
	2.2 HDi 150	110		03.11	heavy payload 160 <sup>3)</sup>			
	3.0 HDi 145	107		04.10	heavy payload 160 <sup>3)</sup>			
	3.0 HDi 160	116		04.06	heavy payload 160 <sup>3)</sup>			
	3.0 HDi 175	130		03.11	heavy payload 160 <sup>3)</sup>			
		2.2 HDi 100	74		04.06	payload 200 <sup>4)</sup>		
2.2 HDi 110		81		03.11	payload 200 <sup>4)</sup>			
2.2 HDi 120		88		04.06	payload 200 <sup>4)</sup>			
2.2 HDi 130		96		03.11	payload 200 <sup>4)</sup>			
2.2 HDi 150		110		03.11	payload 200 <sup>4)</sup>			
3.0 HDi 145		107		04.10	payload 200 <sup>4)</sup>			
3.0 HDi 160		116		04.06	payload 200 <sup>4)</sup>			
3.0 HDi 175		130		03.11	payload 200 <sup>4)</sup>			

<sup>1)</sup> carico utile 120/140 / charge utile 120/140 / carga útil 120/140 / Nutzlast 120/140  
<sup>2)</sup> carico utile leggero 160 / charge utile légère 160 / carga útil ligera 160 / Nutzlast leicht 160  
<sup>3)</sup> carico utile pesante 160 / charge utile lourde 160 / carga útil pesada 160 / Nutzlast schwer 160  
<sup>4)</sup> carico utile 200 / charge utile 200 / carga útil 200 / Nutzlast 200







### PEUGEOT BOXER (06-)

	2.2 HDi 100	74		<b>04.06</b>	payload 120/140 <sup>1)</sup>	<b>G2124127</b>	+ steel rims <sup>2)</sup>	280 24,0 21,9 V +C				
	2.2 HDi 110	81		<b>03.11</b>	payload 120/140 <sup>1)</sup>							
	2.2 HDi 120	88		<b>04.06</b>	payload 120/140 <sup>1)</sup>							
	2.2 HDi 130	96		<b>03.11</b>	payload 120/140 <sup>1)</sup>							
	2.2 HDi 150	110		<b>03.11</b>	payload 120/140 <sup>1)</sup>							
	3.0 HDi 145	107		<b>04.10</b>	payload 120/140 <sup>1)</sup>							
	3.0 HDi 160	116		<b>04.06</b>	payload 120/140 <sup>1)</sup>							
	3.0 HDi 175	130		<b>03.11</b>	payload 120/140 <sup>1)</sup>							
	2.2 HDi 100	74		<b>04.06</b>	heavy payload 160 <sup>3)</sup>	<b>G2124138</b>	+ steel rims <sup>2)</sup>	300 24,0 21,9 V +C				
	2.2 HDi 110	81		<b>03.11</b>	heavy payload 160 <sup>3)</sup>							
	2.2 HDi 120	88		<b>04.06</b>	heavy payload 160 <sup>3)</sup>							
	2.2 HDi 130	96		<b>03.11</b>	heavy payload 160 <sup>3)</sup>							
	2.2 HDi 150	110		<b>03.11</b>	heavy payload 160 <sup>3)</sup>							
	3.0 HDi 145	107		<b>04.10</b>	heavy payload 160 <sup>3)</sup>							
3.0 HDi 160	116		<b>04.06</b>	heavy payload 160 <sup>3)</sup>								
3.0 HDi 175	130		<b>03.11</b>	heavy payload 160 <sup>3)</sup>								
	2.2 HDi 100	74		<b>04.06</b>		<b>G1020730</b>		24465 19,2 /Acc/S <b>BRE</b>				
	2.2 HDi 110	81		<b>03.11</b>								
	2.2 HDi 120	88		<b>04.06</b>								
	2.2 HDi 130	96		<b>03.11</b>								
	2.2 HDi 150	110		<b>03.11</b>								
	3.0 HDi 145	107		<b>04.10</b>								
	3.0 HDi 160	116		<b>04.06</b>								
	3.0 HDi 175	130		<b>03.11</b>								
		2.2 HDi 100	74		<b>04.06</b>				payload 120/140+ light 160 <sup>4)</sup>	<b>G2116124</b>	+ steel rims <sup>2)</sup>	280 16,0 14,2 +C
		2.2 HDi 110	81		<b>03.11</b>				payload 120/140+ light 160 <sup>4)</sup>			
2.2 HDi 120		88		<b>04.06</b>	payload 120/140+ light 160 <sup>4)</sup>							
2.2 HDi 130		96		<b>03.11</b>	payload 120/140+ light 160 <sup>4)</sup>							
2.2 HDi 150		110		<b>03.11</b>	payload 120/140+ light 160 <sup>4)</sup>							
3.0 HDi 145		107		<b>04.10</b>	payload 120/140+ light 160 <sup>4)</sup>							
3.0 HDi 160		116		<b>04.06</b>	payload 120/140+ light 160 <sup>4)</sup>							
3.0 HDi 175		130		<b>03.11</b>	payload 120/140+ light 160 <sup>4)</sup>							
2.2 HDi 100		74		<b>04.06</b>	payload 200 <sup>5)</sup>	<b>G2116123</b>	+ steel rims <sup>2)</sup>	300 16,0 14,2 +C				
2.2 HDi 110		81		<b>03.11</b>	payload 200 <sup>5)</sup>							
2.2 HDi 120		88		<b>04.06</b>	payload 200 <sup>5)</sup>							
2.2 HDi 130		96		<b>03.11</b>	payload 200 <sup>5)</sup>							
2.2 HDi 150		110		<b>03.11</b>	payload 200 <sup>5)</sup>							
3.0 HDi 145		107		<b>04.10</b>	payload 200 <sup>5)</sup>							
3.0 HDi 160	116		<b>04.06</b>	payload 200 <sup>5)</sup>								
3.0 HDi 175	130		<b>03.11</b>	payload 200 <sup>5)</sup>								

### PEUGEOT EXPERT Estate (95-06)

	1.6	58	ORGA 09792	<b>10.95</b>		<b>G1020310</b>		21801 19,0 +/W/S <b>LUC</b>
	1.8	74	ORGA 09792	<b>10.96</b>				
	1.9 D	51	ORGA 09155	<b>10.95</b>				
	1.9 TD	66	ORGA 09792	<b>10.95</b>				
	1.9 TD	68	ORGA 09792	<b>04.96</b>				
	2.0 16V	100	ORGA 09792	<b>07.00</b>				
	2.0 HDi	69	ORGA 09792	<b>07.00</b>				
	2.0 HDi	80	ORGA 09792	<b>07.00</b>				
	1.6	58	ORGA 09155	<b>01.96</b>		<b>G1020350</b>		23042 19,0 /W/Acc <b>BDX</b>
	1.9 D	51	ORGA 09155	<b>12.06</b>				
	1.6	58	ORGA 09793	<b>12.06</b>		<b>G1020514</b>		20261 19,0 +/W/S <b>LUC</b>
	1.8	74	ORGA 09793	<b>12.06</b>				
	1.9 TD	66	ORGA 09793	<b>12.06</b>				
	1.9 TD	68	ORGA 09793	<b>12.06</b>				
	2.0 16V	100	ORGA 09793	<b>12.06</b>				
	2.0 HDi	69	ORGA 09793	<b>12.06</b>				
	2.0 HDi	80	ORGA 09793	<b>12.06</b>				
		1.6	58	ORGA 09155	<b>10.95</b>			
1.8		74	ORGA 09155	<b>10.96</b>				
1.9 D		51	ORGA 09155	<b>10.95</b>				
1.9 TD		66	ORGA 09155	<b>10.95</b>				
1.9 TD		68	ORGA 09155	<b>04.96</b>				
2.0 16V		100	ORGA 09155	<b>07.00</b>				
2.0 HDi		69	ORGA 09155	<b>07.00</b>				
2.0 HDi		80	ORGA 09155	<b>07.00</b>				

### PEUGEOT EXPERT Van (95-06)

	1.6	58	ORGA 09155	<b>10.95</b>	+ 0,8 t	<b>G1020350</b>		23042 19,0 /W/Acc <b>BDX</b>				
	1.8	74	ORGA 09155	<b>10.96</b>	+ 0,8 t							
	1.9 D	51	ORGA 09155	<b>10.95</b>	+ 0,8 t							
	1.9 TD	66	ORGA 09155	<b>10.95</b>	+ 0,8 t							
	1.9 TD	68	ORGA 09155	<b>04.96</b>	+ 0,8 t							
	2.0 16V	100	ORGA 09155	<b>07.00</b>	+ 0,8 t							
	2.0 HDi	69	ORGA 09155	<b>07.00</b>	+ 0,8 t							
	2.0 HDi	80	ORGA 09155	<b>07.00</b>	+ 0,8 t							
		1.6	58	ORGA 09792	<b>10.95</b>				+ 0,9 t	<b>G1020310</b>		21801 19,0 +/W/S <b>LUC</b>
		1.6	58	ORGA 09155					+ 0,8 t			
1.8		74	ORGA 09792	<b>10.96</b>	+ 0,9 t							
1.8		74	ORGA 09155		+ 0,8 t							
1.9 D		51	ORGA 09792	<b>10.95</b>	+ 0,9 t							
1.9 D		51	ORGA 09155		+ 0,8 t							
1.9 TD		66	ORGA 09792	<b>10.95</b>	+ 0,9 t							
1.9 TD		66	ORGA 09155		+ 0,8 t							
1.9 TD		68	ORGA 09792	<b>04.96</b>	+ 0,9 t							

<sup>1)</sup> carico utile 120/140 / charge utile 120/140 / carga útil 120/140 / Nutzlast 120/140

<sup>2)</sup> + cerchi in acciaio / + jantes en acier / + Llantas acero / + Stahlfelgen

<sup>3)</sup> carico utile pesante 160 / charge utile lourde 160 / carga útil pesada 160 / Nutzlast schwer 160

<sup>4)</sup> carico utile 120/140+ leggero 160 / charge utile 120/140+ légère 160 / carga útil 120/140+ ligera 160 / Nutzlast 120/140+ leicht 160























<sup>5)</sup> carico utile 200 / charge utile 200 / carga útil 200 / Nutzlast 200



PEUGEOT EXPERT Van (95-06)																		
	1.9 TD	68	ORGA 09156	ORGA 09792		+ 0,8 t	G1020310		21801 19,0 +/W/S	LUC								
	2.0 16V	100		ORGA 09792	07.00	+ 0,9 t												
	2.0 16V	100	ORGA 09156	ORGA 09792		+ 0,8 t												
	2.0 HDi	69		ORGA 09792	07.00	+ 0,9 t												
	2.0 HDi	69	ORGA 09156	ORGA 09792		+ 0,8 t												
	2.0 HDi	80		ORGA 09792	07.00	+ 0,9 t												
	2.0 HDi	80	ORGA 09156	ORGA 09792		+ 0,8 t												
	1.6	58	ORGA 09793			12.06 + 0,8/0,9 t					G1020514		20261 19,0 +/W/S	LUC				
	1.8	74	ORGA 09793			12.06 + 0,8/0,9 t												
	1.9 D	51	ORGA 09793			12.06 + 0,8/0,9 t												
1.9 TD	66	ORGA 09793			12.06 + 0,8/0,9 t													
1.9 TD	68	ORGA 09793			12.06 + 0,8/0,9 t													
2.0 16V	100	ORGA 09793			12.06 + 0,8/0,9 t													
2.0 HDi	69	ORGA 09793			12.06 + 0,8/0,9 t													
2.0 HDi	80	ORGA 09793			12.06 + 0,8/0,9 t													
	1.6	58	ORGA 09155	10.95		+ 0,8 t	G2120155		258 20,0 18,2 V L + C									
	1.8	74	ORGA 09155	10.96		+ 0,8 t												
	1.9 D	51	ORGA 09155	10.95		+ 0,8 t												
	1.9 TD	66	ORGA 09155	10.95		+ 0,8 t												
	1.9 TD	68	ORGA 09155	04.96		+ 0,8 t												
	2.0 16V	100	ORGA 09155	07.00		+ 0,8 t												
	2.0 HDi	69	ORGA 09155	07.00		+ 0,8 t												
	2.0 HDi	80	ORGA 09155	07.00		+ 0,8 t												
	PEUGEOT EXPERT Pickup/Chassis (95-06)																	
		1.6	58	ORGA 09792	10.95							G1020310		21801 19,0 +/W/S	LUC			
1.9 D		51	ORGA 09792	10.95														
1.9 TD		66	ORGA 09792	10.95														
1.9 TD		68	ORGA 09792	04.96														
	1.6	58	ORGA 09793			12.06	G1020514		20261 19,0 +/W/S	LUC								
	1.9 D	51	ORGA 09793			12.06												
	1.9 TD	66	ORGA 09793			12.06												
	1.9 TD	68	ORGA 09793			12.06												
PEUGEOT EXPERT / Expert Tepee (07-)																		
	1.6 HDi 90	66		01.07			G1020937		24595 18,5 +/W/Acc/S	LUC								
	2.0 HDi 100	72		03.11														
	2.0 HDi 120	88		01.07														
	2.0 HDi 120 4x4	88		01.07														
	2.0 HDi 130	94		03.11														
	2.0 HDi 140	100		01.07														
	2.0 HDi 165	120		09.09														
	2.0 i 16V	103		01.07														
	1.6 HDi 90	66		01.07		+ long wheel base <sup>1)</sup>	G1020938		24578 16,5 /Acc/S	LUC								
	2.0 HDi 100	72		03.11														
	2.0 HDi 120	88		01.07														
	2.0 HDi 120 4x4	88		01.07														
	2.0 HDi 130	94		03.11														
	2.0 HDi 140	100		01.07														
	2.0 HDi 165	120		09.09														
	2.0 i 16V	103		01.07														
PEUGEOT PARTNER Estate (96-08)																		
	1.1 i	44		07.96	09.02		G1020451		23124 19,0 +/W/S	LUC								
	1.4 i	55		07.96	09.02													
	1.6 16V	80	ORGA 09127	07.01														
	1.8 i	66	ORGA 09127	05.97														
	1.9 D	50	ORGA 09127	07.96														
	1.9 D	51	ORGA 09127	12.98														
	2.0 HDi 90	66	ORGA 09127	02.00														
	1.6 16V	80	ORGA 09128		03.08	+ ESP					G1020614		23708 19,0 /S	BOS				
	1.6 HDi 75	55		02.06	03.08	+ ESP												
	1.6 HDi 90	66		02.06	03.08	+ ESP												
2.0 HDi 90	66	ORGA 09128		03.08	+ ESP													
	1.1 i	44		07.96	09.02		G2113184		266 13,0 11,0 +S +C									
	1.4 i	55		07.96	09.02													
	1.4 i	55	ORGA 09127	10.02							G2120133		266 20,5 18,5 V +S +C					
	1.6 16V	80	ORGA 09127	07.01														
	1.8 i	66	ORGA 09127	05.97														
	1.9 D	50	ORGA 09127	07.96														
	1.9 D	51	ORGA 09127	12.98														
	2.0 HDi 90	66	ORGA 09127	02.00														
	1.1 i	44		10.02	03.08										G2122194		266 22,0 20,0 V +S +C	
	1.4 i	55	ORGA 09128		03.08													
1.6 16V	80	ORGA 09128		03.08	- ESP													
1.6 HDi 75	55		02.06	03.08	- ESP													
1.6 HDi 90	66		02.06	03.08	- ESP													
1.8 i	66	ORGA 09128		03.08														
1.9 D	50	ORGA 09128		03.08														
1.9 D	51	ORGA 09128		03.08														
2.0 HDi 90	66	ORGA 09128		03.08	- ESP													
1.6 16V	80	ORGA 09128		03.08	+ ESP	G2126120		283 26,0 24,0 V +S +C										
1.6 HDi 75	55		02.06	03.08	+ ESP													
1.6 HDi 90	66		02.06	03.08	+ ESP													
2.0 HDi 90	66	ORGA 09128		03.08	+ ESP													

<sup>1)</sup> + passo lungo / + empattement long / + distancia larga entre ejes / + langer Radstand



												
<b>PEUGEOT PARTNER Estate (96-08)</b>												
	1.6 16V	80		07.01	03.08	+ ESP	G1020492	23554 17,1 /WD/S	LUC			
	1.6 HDi 75	55		02.06	03.08	+ ESP						
	1.6 HDi 90	66		02.06	03.08	+ ESP						
	2.0 HDi 90	66		02.00	03.08	+ ESP						
	1.6 16V	80		07.01	03.08	+ ESP	G2109137	247 9,0 8,0 +S +C				
	1.6 HDi 75	55		02.06	03.08	+ ESP						
	1.6 HDi 90	66		02.06	03.08	+ ESP						
	2.0 HDi 90	66		02.00	03.08	+ ESP						
<b>PEUGEOT PARTNER Van (96-08)</b>												
	1.1 i	44		07.96	09.02		G1020451	23124 19,0 +/W/S	LUC			
	1.4 i	55		07.96	09.02							
	1.8 D	43	ORGA 09127	07.96								
	1.8 D	44	ORGA 09127	11.96								
	1.9 D	51	ORGA 09127	07.96								
	2.0 HDi 90	66	ORGA 09127	04.00								
	2.0 HDi 90	66	ORGA 09128		03.08	+ ESP	G1020614	23708 19,0 /S	BOS			
	1.1 i	44		07.96	09.02		G2113184	266 13,0 11,0 +S +C				
	1.4 i	55		07.96	09.02		G2120133	266 20,5 18,5 V +S +C				
	1.8 D	43	ORGA 09127	07.96								
	1.8 D	44	ORGA 09127	11.96								
	1.9 D	51	ORGA 09127	07.96								
	2.0 HDi 90	66	ORGA 09127	04.00								
	1.1 i	44		10.02	03.08					G2122194	266 22,0 20,0 V +S +C	
	1.4 i	55		10.02	03.08							
	1.6 HDi 75	55		02.06	03.08							
	1.6 HDi 90	66		02.06	03.08							
	1.8 D	43	ORGA 09128	03.08								
1.8 D	44	ORGA 09128	02.98									
1.9 D	51	ORGA 09128	03.08									
2.0 HDi 90	66	ORGA 09128	03.08	- ESP								
2.0 HDi 90	66	ORGA 09128	03.08	+ ESP		G2126120	283 26,0 24,0 V +S +C					
	2.0 HDi 90	66		04.00	03.08	+ ESP	G1020492	23554 17,1 /WD/S	LUC			
	2.0 HDi 90	66		04.00	03.08	+ ESP	G2109137	247 9,0 8,0 +S +C				
<b>PEUGEOT PARTNER Tepee/Van (B9) (08-)</b>												
	1.6	72		08.10			G1020790	24538 18,5 +	ATE			
	1.6	88		04.10								
	1.6 HDi	55		04.08								
	1.6 HDi	66		04.08								
	1.6 HDi	80		04.08								
	1.6 HDi	82		08.10								
	1.6 HDi 115	84		03.13								
	1.6 HDi 4x4	66		04.12								
	1.6 i 16V	66		04.08								
	1.6 i 16V	80		04.08								
	1.6	72		08.10			G2126120	283 26,0 24,0 V +S +C				
	1.6	88		04.10								
	1.6 HDi	55		04.08								
	1.6 HDi	66		04.08								
	1.6 HDi	80		04.08								
	1.6 HDi	82		08.10								
	1.6 HDi 115	84		03.13								
	1.6 HDi 4x4	66		04.12								
	1.6 i 16V	66		04.08								
	1.6 i 16V	80		04.08								
	1.6	72		08.10			G1020921	24765 16,5 /Acc/S	LUC			
	1.6	88		04.10								
	1.6 HDi	55		04.08								
	1.6 HDi	66		04.08								
	1.6 HDi	80		04.08								
	1.6 HDi	82		08.10								
	1.6 HDi 115	84		03.13								
	1.6 HDi 4x4	66		04.12								
	1.6 i 16V	66		04.08								
	1.6 i 16V	80		04.08								
<b>PEUGEOT RCZ (10-)</b>												
	1.6 16V	115		03.10			G1020745	23589 19,1 +	ATE			
	2.0 HDi	120		03.10		+ 18" wheel 1)						
	1.6 16V	115		03.10			G1020946	24922 17,5 /Acc/S	LUC			
	1.6 16V	147		03.10								
	2.0 HDi	120		03.10								
	1.6 16V	115		03.10			G2112162	290 12,0 10,0 +S +C				
	1.6 16V	147		06.10								
	2.0 HDi	120		03.10								

1) + ruota 18" / + roue 18" / + rueda 18" / + 18" Rad

<b>PORSCHE 911 (996) (97-05)</b>											
	3.4 CARRERA			09.97	09.01			G1020882			23329 17,0 /WD BRE
	3.4 CARRERA 4			06.97	09.01						
	3.6 CARRERA			10.01	08.05						
	3.6 CARRERA 4			10.01	08.05						
	3.6 CARRERA			01.02	12.02			G1020785	- ceramic brake <sup>1)</sup>		23330 17,0 /WD BRE
	3.6 CARRERA 4			01.02	12.02						
	3.6 TURBO 4			06.00	08.05						
	3.4 CARRERA			09.97	09.01			G1020883			21792 15,5 /WD BRE
	3.4 CARRERA 4			06.97	09.01						
	3.6 CARRERA			10.01	08.05						
	3.6 CARRERA 4			10.01	08.05						
	3.6 CARRERA			01.02	08.05			G1020882	- ceramic brake <sup>1)</sup>		23329 17,0 /WD BRE
	3.6 CARRERA 4			01.02	08.05						
	3.6 TURBO 4			01.02	08.08						
	3.6 GT3			03.99	08.05			G1020882	- ceramic brake <sup>1)</sup>		23329 17,0 /WD BRE
<b>PORSCHE 911 TARGA (996) (01-05)</b>											
	3.6	235		12.01	08.05			G1020882			23329 17,0 /WD BRE
	3.6	235		12.01	08.05			G1020883			21792 15,5 /WD BRE
<b>PORSCHE 911 CONVERTIBLE (996) (98-05)</b>											
	3.4 CARRERA			02.98	09.01			G1020882			23329 17,0 /WD BRE
	3.4 CARRERA 4			02.98	09.01						
	3.6 CARRERA			10.01	08.05						
	3.6 CARRERA 4			10.01	08.05						
	3.6 CARRERA			01.02	08.05			G1020785	- ceramic brake <sup>1)</sup>		23330 17,0 /WD BRE
	3.6 CARRERA 4			01.02	08.05						
	3.6 TURBO 4			10.03	08.05						
	3.4 CARRERA			02.98	09.01			G1020883			21792 15,5 /WD BRE
	3.4 CARRERA 4			02.98	09.01						
	3.6 CARRERA			10.01	08.05						
	3.6 CARRERA 4			10.01	08.05						
	3.4 CARRERA			02.98	09.01			G1020882	- ceramic brake <sup>1)</sup>		23329 17,0 /WD BRE
	3.4 CARRERA 4			02.98	09.01						
	3.6 CARRERA			10.01	08.05						
	3.6 CARRERA 4			10.01	08.05						
	3.6 TURBO 4			10.03	08.05						
<b>PORSCHE 911 COUPE (997) (04-)</b>											
	3.8 Carrera S	261		07.04				G1020785	- ceramic brake <sup>1)</sup>		23330 17,0 /WD BRE
	3.8 Carrera S	280		08.05					- ceramic brake <sup>1)</sup>		
	3.8 Carrera 4S	261		07.04				G1020785	- ceramic brake <sup>1)</sup>		23330 17,0 /WD BRE
	3.8 Carrera 4S	280		08.05					- ceramic brake <sup>1)</sup>		
	3.6 Carrera	239		07.04				G1020883	- ceramic brake <sup>1)</sup>		21792 15,5 /WD BRE
	3.6 Carrera 4	239		07.04					- ceramic brake <sup>1)</sup>		
<b>PORSCHE 911 CONVERTIBLE (997) (05-)</b>											
	3.6 Carrera	239		04.05				G1020882	- sport design/- ceramic brake <sup>2)</sup>		23329 17,0 /WD BRE
	3.8 Carrera S	261		04.05				G1020785	- ceramic brake <sup>1)</sup>		23330 17,0 /WD BRE
	3.8 Carrera S	280		08.05							
	3.8 Carrera S	283		06.08							
	3.8 Carrera 4S	261		04.05				G1020785	- ceramic brake <sup>1)</sup>		23330 17,0 /WD BRE
	3.8 Carrera 4S	280		08.05							
	3.8 Carrera 4S	283		06.08							
	3.6 Carrera	239		04.05				G1020883	- sport design/- ceramic brake <sup>2)</sup>		21792 15,5 /WD BRE
	3.6 Carrera 4	239		04.05				G1020883	- ceramic brake <sup>1)</sup>		21792 15,5 /WD BRE
<b>PORSCHE BOXSTER (986) (96-04)</b>											
	3.2 S	185		08.99	06.02			G1020882			23329 17,0 /WD BRE
	3.2 S	191		07.02	12.04						
	3.2 S	196		01.04	12.04						
	2.5	150		09.96	07.99			G1020883			21792 15,5 /WD BRE
	2.7	162		08.99	06.02						
	2.7	168		07.02	12.04						
	3.2 S	185		08.99	06.02			G1020883			21792 15,5 /WD BRE
	3.2 S	191		07.02	12.04						
	3.2 S	196		01.04	12.04						
<b>PORSCHE BOXSTER (987) (05-11)</b>											
	3.2 S	206		11.04	07.06			G1020883	- ceramic brake <sup>1)</sup>		21792 15,5 /WD BRE
	3.4 S	217		06.06	09.11						
	3.4 S	228		06.09	09.11						
	3.4 S RS SPYDER	223		08.08	09.11						

<sup>1)</sup> - freno in ceramica / - frein de céramique / - freno de cerámica / - Keramikbremse

<sup>2)</sup> - versio.sportiva/-fr.ceramica / - réalis.sport/-fr.d.ceramique / - realiz.deporte/- fr.cerámica / - Sportausführung/- Keramikbr.

<b>PORSCHE CAYENNE I (03-10)</b>												
	3.0 TDI	176		<b>02.09</b>	<b>04.10</b> + 17" wheel/ + black caliper <sup>1)</sup>	<b>G1020709</b>		23692 16,6 /WD	<b>BRE</b>			
	3.2	177		<b>08.03</b>	<b>04.10</b> + 17" wheel/ + black caliper <sup>1)</sup>							
	3.2	184		<b>10.03</b>	<b>12.06</b> + 17" wheel/ + black caliper <sup>1)</sup>							
	3.6	213		<b>01.07</b>	<b>04.10</b> + 17" wheel/ + black caliper <sup>1)</sup>							
	<b>GTS 4.8</b>	298		<b>10.07</b>	<b>04.10</b> + 17" wheel/ + black caliper <sup>1)</sup>							
	S 4.5	250		<b>09.02</b>	<b>12.06</b> + 17" wheel/ + black caliper <sup>1)</sup>	<b>G1020709</b>		23692 16,6 /WD	<b>BRE</b>			
	S 4.8	283		<b>01.07</b>	<b>04.10</b> + 17" wheel/ + black caliper <sup>1)</sup>							
	Turbo 4.5	331		<b>09.02</b>	<b>12.06</b> + 17" wheel/ + black caliper <sup>1)</sup>							
	Turbo S 4.5	368		<b>01.04</b>	<b>04.10</b> + 17" wheel/ + black caliper <sup>1)</sup>							
	Turbo S 4.5	383		<b>01.04</b>	<b>04.10</b> + 17" wheel/ + black caliper <sup>1)</sup>							
Turbo S 4.8	368		<b>01.07</b>	<b>04.10</b> + 17" wheel/ + black caliper <sup>1)</sup>								
Turbo S 4.8	397		<b>02.07</b>	<b>12.09</b> + 17" wheel/ + black caliper <sup>1)</sup>								
Turbo S 4.8	404		<b>08.08</b>	<b>04.10</b> + 17" wheel/ + black caliper <sup>1)</sup>								
3.0 TDI	176		<b>02.09</b>	<b>04.10</b> + 18" wheel/ + silver caliper <sup>2)</sup>	<b>G1020710</b>						23693 16,6 /WD	<b>BRE</b>
3.2	177		<b>08.03</b>	<b>04.10</b> + 18" wheel/ + silver caliper <sup>2)</sup>								
3.2	184		<b>10.03</b>	<b>12.06</b> + 18" wheel/ + silver caliper <sup>2)</sup>								
3.6	213		<b>01.07</b>	<b>04.10</b> + 18" wheel/ + silver caliper <sup>2)</sup>								
<b>GTS 4.8</b>	298		<b>10.07</b>	<b>04.10</b> + 18" wheel/ + silver caliper <sup>2)</sup>								
S 4.5	250		<b>09.02</b>	<b>12.06</b> + 18" wheel/ + silver caliper <sup>2)</sup>	<b>G1020710</b>		23693 16,6 /WD	<b>BRE</b>				
S 4.8	283		<b>01.07</b>	<b>04.10</b> + 18" wheel/ + silver caliper <sup>2)</sup>								
Turbo 4.5	331		<b>09.02</b>	<b>12.06</b> + 18" wheel/ + silver caliper <sup>2)</sup>								
Turbo S 4.5	368		<b>01.04</b>	<b>04.10</b> + 18" wheel/ + silver caliper <sup>2)</sup>								
Turbo S 4.5	383		<b>01.04</b>	<b>04.10</b> + 18" wheel/ + silver caliper <sup>2)</sup>								
Turbo S 4.8	368		<b>01.07</b>	<b>01.07</b> + 18" wheel/ + silver caliper <sup>2)</sup>								
Turbo S 4.8	397		<b>02.07</b>	<b>04.10</b> + 18" wheel/ + silver caliper <sup>2)</sup>								
Turbo S 4.8	404		<b>08.08</b>	<b>04.10</b> + 18" wheel/ + silver caliper <sup>2)</sup>								
3.0 TDI	176		<b>02.09</b>	<b>04.10</b> + 18" wheel/ + red caliper <sup>3)</sup>					<b>G1020710</b>		23693 16,6 /WD	<b>BRE</b>
3.2	177		<b>08.03</b>	<b>04.10</b> + 18" wheel/ + red caliper <sup>3)</sup>								
3.2	184		<b>10.03</b>	<b>12.06</b> + 18" wheel/ + red caliper <sup>3)</sup>								
3.6	213		<b>01.07</b>	<b>04.10</b> + 18" wheel/ + red caliper <sup>3)</sup>								
<b>GTS 4.8</b>	298		<b>10.07</b>	<b>04.10</b> + 18" wheel/ + red caliper <sup>3)</sup>								
S 4.5	250		<b>09.02</b>	<b>04.10</b> + 18" wheel/ + red caliper <sup>3)</sup>	<b>G1020710</b>		23693 16,6 /WD	<b>BRE</b>				
S 4.8	283		<b>01.07</b>	<b>04.10</b> + 18" wheel/ + red caliper <sup>3)</sup>								
Turbo 4.5	331		<b>09.02</b>	<b>12.06</b> + 18" wheel/ + red caliper <sup>3)</sup>								
Turbo S 4.5	368		<b>01.04</b>	<b>04.10</b> + 18" wheel/ + red caliper <sup>3)</sup>								
Turbo S 4.5	383		<b>01.04</b>	<b>04.10</b> + 18" wheel/ + red caliper <sup>3)</sup>								
Turbo S 4.8	368		<b>01.07</b>	<b>04.10</b> + 18" wheel/ + red caliper <sup>3)</sup>								
Turbo S 4.8	397		<b>02.07</b>	<b>04.10</b> + 18" wheel/ + red caliper <sup>3)</sup>								
Turbo S 4.8	404		<b>08.08</b>	<b>04.10</b> + 18" wheel/ + red caliper <sup>3)</sup>								
3.0 TDI	176		<b>02.09</b>	<b>04.10</b> + 18" wheel/ + red caliper <sup>3)</sup>					<b>G1201079</b>		24553 15,8 /WD	<b>BRE</b>
3.2	177		<b>08.03</b>	<b>04.10</b> + 18" wheel/ + red caliper <sup>3)</sup>								
3.2	184		<b>10.03</b>	<b>12.06</b> + 18" wheel/ + red caliper <sup>3)</sup>								
3.6	213		<b>01.07</b>	<b>04.10</b> + 18" wheel/ + red caliper <sup>3)</sup>								
<b>GTS 4.8</b>	298		<b>10.07</b>	<b>04.10</b> + 18" wheel/ + red caliper <sup>3)</sup>								
S 4.5	250		<b>08.02</b>	<b>12.06</b> + 18" wheel/ + red caliper <sup>3)</sup>	<b>G1201079</b>		24553 15,8 /WD	<b>BRE</b>				
S 4.8	283		<b>01.07</b>	<b>04.10</b> + 18" wheel/ + red caliper <sup>3)</sup>								
Turbo 4.5	331		<b>09.02</b>	<b>12.06</b> + 18" wheel/ + red caliper <sup>3)</sup>								
Turbo S 4.5	368		<b>01.04</b>	<b>04.10</b> + 18" wheel/ + red caliper <sup>3)</sup>								
Turbo S 4.5	383		<b>01.04</b>	<b>04.10</b> + 18" wheel/ + red caliper <sup>3)</sup>								
Turbo S 4.8	368		<b>01.07</b>	<b>04.10</b> + 18" wheel/ + red caliper <sup>3)</sup>								
Turbo S 4.8	397		<b>02.07</b>	<b>04.10</b> + 18" wheel/ + red caliper <sup>3)</sup>								
Turbo S 4.8	404		<b>08.08</b>	<b>04.10</b> + 18" wheel/ + red caliper <sup>3)</sup>								
3.0 TDI	176		<b>02.09</b>	<b>04.10</b> + 19" wheel/ + red caliper <sup>4)</sup>					<b>G1201066</b>		23961 16,8 /WD	<b>BRE</b>
3.2	177		<b>08.03</b>	<b>04.10</b> + 19" wheel/ + red caliper <sup>4)</sup>								
3.2	184		<b>01.05</b>	<b>12.06</b> + 19" wheel/ + red caliper <sup>4)</sup>								
3.6	213		<b>01.07</b>	<b>04.10</b> + 19" wheel/ + red caliper <sup>4)</sup>								
<b>GTS 4.8</b>	298		<b>10.07</b>	<b>04.10</b> + 19" wheel/ + red caliper <sup>4)</sup>								
S 4.5	250		<b>01.05</b>	<b>12.06</b> + 19" wheel/ + red caliper <sup>4)</sup>	<b>G1201066</b>		23961 16,8 /WD	<b>BRE</b>				
S 4.8	283		<b>01.07</b>	<b>04.10</b> + 19" wheel/ + red caliper <sup>4)</sup>								
Turbo 4.5	331		<b>01.05</b>	<b>12.06</b> + 19" wheel/ + red caliper <sup>4)</sup>								
Turbo S 4.5	368		<b>01.04</b>	<b>04.10</b> + 19" wheel/ + red caliper <sup>4)</sup>								
Turbo S 4.5	383		<b>01.04</b>	<b>04.10</b> + 19" wheel/ + red caliper <sup>4)</sup>								
Turbo S 4.8	368		<b>01.07</b>	<b>04.10</b> + 19" wheel/ + red caliper <sup>4)</sup>								
Turbo S 4.8	397		<b>02.07</b>	<b>04.10</b> + 19" wheel/ + red caliper <sup>4)</sup>								
Turbo S 4.8	404		<b>08.08</b>	<b>04.10</b> + 19" wheel/ + red caliper <sup>4)</sup>								
3.2	184		<b>10.03</b>	<b>12.06</b> + 17" wheel <sup>5)</sup>					<b>G1020711</b>		23694 16,4 /WD	<b>BRE</b>
3.6	213		<b>01.07</b>	<b>12.09</b> + 17" wheel <sup>5)</sup>								
<b>GTS 4.8</b>	298		<b>10.07</b>	<b>12.09</b> + 17" wheel/ + red caliper <sup>6)</sup>								
S 4.5	250		<b>09.02</b>	<b>12.06</b> + 17" wheel <sup>5)</sup>								
S 4.8	283		<b>01.07</b>	<b>12.09</b> + 17" wheel <sup>5)</sup>								
Turbo 4.5	331		<b>09.02</b>	<b>12.06</b> + 17" wheel <sup>5)</sup>	<b>G1020711</b>		23694 16,4 /WD	<b>BRE</b>				
Turbo S 4.8	368		<b>01.07</b>	<b>12.09</b> + 17" wheel <sup>5)</sup>								
3.2	184		<b>01.05</b>	<b>12.06</b> + 18" wheel <sup>7)</sup>								
S 4.5	250		<b>01.05</b>	<b>12.06</b> + 18" wheel <sup>7)</sup>								
Turbo 4.5	331		<b>01.05</b>	<b>12.06</b> + 18" wheel <sup>7)</sup>								
3.6	213		<b>01.07</b>	<b>12.09</b> + 18" wheel <sup>7)</sup>					<b>G1020999</b>		24296 15,5 /WD	<b>BRE</b>
S 4.8	283		<b>01.07</b>	<b>12.09</b> + 18" wheel <sup>7)</sup>								
Turbo S 4.8	368		<b>01.07</b>	<b>12.09</b> + 18" wheel <sup>7)</sup>								

**PORSCHE CAYMAN (987C) (05-12)**

	3.4 S	217		<b>11.05</b>	<b>05.12</b>	<b>G1020883</b>		- ceramic brake <sup>8)</sup>	21792 15,5 /WD	<b>BRE</b>
--	-------	-----	--	--------------	--------------	-----------------	--	-------------------------------	----------------	------------

1) + ruota 17"/ + pinza nero / + roue 17"/ + étrier noir / + rueda 17"/ + pinza negro / + 17" Rad/ + schwarzer Sattel  
2) + ruota 18"/ + pinza argento / + roue 18"/ + étrier argent / + rueda 18"/ + pinza plata / + 18" Rad/ + silberner Sattel  
3) + ruota 18"/ + pinza rosso / + roue 18"/ + étrier rouge / + rueda 18"/ + pinza rojo / + 18" Rad/ + roter Sattel  
4) + ruota 19"/ + pinza rosso / + roue 19"/ + étrier rouge / + rueda 19"/ + pinza rojo / + 19" Rad/ + roter Sattel  
5) + ruota 17"/ + roue 17"/ + rueda 17"/ + 17" Rad  
6) + ruota 17"/ + pinza rosso / + roue 17"/ + étrier rouge / + rueda 17"/ + pinza rojo / + 17" Rad/ + roter Sattel  
7) + ruota 18"/ + roue 18"/ + rueda 18"/ + 18" Rad  
8) - freno in ceramica / - frein de céramique / - freno de cerámica / - Keramikbremse



### PORSCHE PANAMERA (10-)

	4.8 4S	294		09.09		G1201079	- ceramic brake <sup>1)</sup>	24553 15,8 /WD	BRE
	4.8 GTS	316		01.12					
	4.8 S	294		09.09					
	4.8 Turbo	368		09.09					
	4.8 Turbo S	404		05.11					

### RENAULT AVANTIME (01-03)

	2.0 16V Turbo	120		11.01	06.03	G1020633		23099 18,4 /S	LUC
	3.0 V6	152		09.01	06.03				
	2.2 dCi	110		05.02	06.03				
	2.0 16V Turbo	120		11.01	06.03	G1020489	remove sliding plates before installation <sup>2)</sup>	23099 18,4 /S	LUC
	2.2 dCi	110		05.02	06.03				
	3.0 V6	152		09.01	06.03				

### RENAULT CAPTUR (J87) (13-)

	0.9 TCe 90	66		06.13		G1020741		23973 17,1 /Acc/S	LUC
	0.9 TCe 90	66		06.13					
	0.9 TCe 90	66		06.13		G2122270		258 22,0 19,8 V L +S +C	

### RENAULT CLIO I Saloon (B/C 57\_) (90-98)

	1.1	34		01.91	04.92	G1020219 G1020501		21097 15,0 +/W/ 21463 18,2 /W/S	BDX LUC
	1.1	34		05.92	09.98				
	1.2	44		05.90	03.96				
	1.2 (5/357F/J/L/R)	43		10.94	09.98				
	1.2 (5/357K.5/357Y)	40		01.96	09.98				
	1.2 (5/357K.5/357Y)	43		01.96	09.98				
	1.2 (B/C 577)	40		01.96	12.96				
	1.2 (B/C 57A/S)	43		05.90	09.98				
	1.2 (B/C 57R)	40		01.91	01.96				
	1.4	59		01.91	09.98				
	1.4 (B/C 57J)	55		01.91	09.98				
	1.4 (B/C 57T/Y)	58		01.91	09.98				
	1.7	68		01.91	04.95				
	1.8	70		01.91	09.98				
	1.8 (B/C 578)	66		08.94	09.98				
	1.8 (B/C 57C/U)	65		01.91	09.98				
	1.8 16V	99		08.91	06.94				
	1.8 Rsi (B/C 579)	80		01.93	08.95				
	1.8 Rsi (B/C 57H)	79		08.95	09.98				
1.9 D	40		01.97	09.98					
1.9 D	47		01.91	09.98					
electronic vehicle	21		05.96	02.98					
Williams (B/C 57M)	108		01.94	09.98					
	1.1	34		01.91	04.92	G2108104 G2112116		238 8,2 7,0 +S +C 238 12,0 10,5 +S +C	
	1.1	34		05.92	09.98				
	1.2	44		05.90	03.96				
	1.2 (5/357F/J/L/R)	43		10.94	09.98				
	1.2 (5/357K.5/357Y)	40		01.96	09.98				
	1.2 (5/357K.5/357Y)	43		01.96	09.98				
	1.2 (B/C 577)	40		01.96	12.96				
	1.2 (B/C 57A/S)	43		05.90	09.98				
	1.2 (B/C 57R)	40		01.91	01.96				
	1.4	59		01.91	09.98 + manual transmission <sup>3)</sup>				
	1.4	59		01.91	03.96 + autom.transmission <sup>4)</sup>				
	1.4 (B/C 57J)	55		01.91	09.98 + manual transmission <sup>3)</sup>				
	1.4 (B/C 57J)	55		01.91	03.96 + autom.transmission <sup>4)</sup>				
	1.4 (B/C 57T/Y)	58		01.91	09.98 + manual transmission <sup>3)</sup>				
	1.4 (B/C 57T/Y)	58		01.91	03.96 + autom.transmission <sup>4)</sup>				
	1.9 D	47		01.91	01.94				
	electronic vehicle	21		05.96	02.98				
	1.4	59		04.96	09.98 + autom.transmission <sup>4)</sup>				
	1.4 (B/C 57J)	55		04.96	09.98 + autom.transmission <sup>4)</sup>				
	1.4 (B/C 57T/Y)	58		04.96	09.98 + autom.transmission <sup>4)</sup>				
	1.4 S	59		01.91	09.98				
	1.4 S (B/C 57J)	55		01.91	09.98				
	1.4 S (B/C 57T/Y)	58		01.91	09.98				
	1.7	68		01.91	04.95				
	1.8	70		01.91	09.98				
	1.8 (B/C 578)	66		08.94	09.98				
	1.8 (B/C 57C/U)	65		01.91	09.98				
	1.8 Rsi (B/C 579)	80		01.93	08.95				
	1.8 Rsi (B/C 57H)	79		08.95	09.98				
1.9 D	40		01.97	09.98					
1.9 D	47		02.94	09.98					
1.8 16V	99		08.91	06.94					
Williams (B/C 57M)	108		01.94	09.98					
	1.2	44		05.90	03.96 + ABS	G1020777		21597 11,0 +/S	BDX
	1.2 (5/357F/J/L/R)	43		10.94	09.98 + ABS				
	1.2 (5/357K.5/357Y)	40		01.96	09.98 + ABS				
	1.2 (5/357K.5/357Y)	43		01.96	09.98 + ABS				
	1.2 (B/C 577)	40		01.96	12.96 + ABS				









1) - freno in ceramica / - frein de céramique / - freno de cerámica / - Keramikkbremse

2) rimuovere le lamiere di scorrimento prima del montaggio / retirer l.plaques coulissantes avant le montage / elimine las chapas de deslizamiento antes del montaje / Gleitbleche vor dem Einbau entfernen

3) + scatola cambio velocità / + transmission mécanique / + cambio de velocidad / + Schaltgetriebe

4) + scatola cambio automatico / + transmission automatique / + cambio automático / + Automatikgetriebe



RENAULT CLIO I Saloon (B/C 57_) (90-98)																																																																																																																																		
	<table border="1"> <tr><td>1.2 (B/C 57A/S)</td><td>43</td><td>05.90</td><td>09.98</td><td>+ ABS</td><td rowspan="20">G1020777</td><td rowspan="20"></td><td rowspan="20">21597 11,0 +/S</td><td rowspan="20">BDX</td></tr> <tr><td>1.2 (B/C 57R)</td><td>40</td><td>01.91</td><td>01.96</td><td>+ ABS</td></tr> <tr><td>1.4</td><td>59</td><td>01.91</td><td>09.98</td><td>+ ABS</td></tr> <tr><td>1.4 (B/C 57J)</td><td>55</td><td>01.91</td><td>09.98</td><td>+ ABS</td></tr> <tr><td>1.4 (B/C 57T/Y)</td><td>58</td><td>01.91</td><td>09.98</td><td>+ ABS</td></tr> <tr><td>1.7</td><td>68</td><td>12.93</td><td>04.95</td><td>+ ABS</td></tr> <tr><td>1.8 (357A)</td><td>70</td><td>10.94</td><td>09.98</td><td>+ ABS</td></tr> <tr><td>1.8 (357D)</td><td>70</td><td>10.94</td><td>04.96</td><td>+ ABS</td></tr> <tr><td>1.8 (357E)</td><td>70</td><td>10.94</td><td>04.96</td><td></td></tr> <tr><td>1.8 (557A)</td><td>70</td><td>08.94</td><td>09.98</td><td>+ ABS</td></tr> <tr><td>1.8 (557D)</td><td>70</td><td>08.94</td><td>04.96</td><td>+ ABS</td></tr> <tr><td>1.8 (557U)</td><td>70</td><td>09.96</td><td>09.98</td><td>+ ABS</td></tr> <tr><td>1.8 (B/C 578)</td><td>66</td><td>08.94</td><td>09.98</td><td>+ ABS</td></tr> <tr><td>1.8 (B/C 57C/U)</td><td>65</td><td>12.93</td><td>09.98</td><td>+ ABS</td></tr> <tr><td>1.8 16V</td><td>99</td><td>08.91</td><td>06.94</td><td></td></tr> <tr><td>1.8 Rsi (B/C 579)</td><td>80</td><td>01.93</td><td>08.95</td><td></td></tr> <tr><td>1.8 Rsi (B/C 57H)</td><td>79</td><td>08.95</td><td>09.98</td><td></td></tr> <tr><td>1.9 D</td><td>40</td><td>01.97</td><td>09.98</td><td>+ ABS</td></tr> <tr><td>1.9 D</td><td>47</td><td>01.91</td><td>09.98</td><td>+ ABS</td></tr> <tr><td>Williams (B/C 57M)</td><td>108</td><td>01.94</td><td>09.98</td><td></td></tr> </table>	1.2 (B/C 57A/S)	43	05.90	09.98	+ ABS	G1020777		21597 11,0 +/S	BDX	1.2 (B/C 57R)	40	01.91	01.96	+ ABS	1.4	59	01.91	09.98	+ ABS	1.4 (B/C 57J)	55	01.91	09.98	+ ABS	1.4 (B/C 57T/Y)	58	01.91	09.98	+ ABS	1.7	68	12.93	04.95	+ ABS	1.8 (357A)	70	10.94	09.98	+ ABS	1.8 (357D)	70	10.94	04.96	+ ABS	1.8 (357E)	70	10.94	04.96		1.8 (557A)	70	08.94	09.98	+ ABS	1.8 (557D)	70	08.94	04.96	+ ABS	1.8 (557U)	70	09.96	09.98	+ ABS	1.8 (B/C 578)	66	08.94	09.98	+ ABS	1.8 (B/C 57C/U)	65	12.93	09.98	+ ABS	1.8 16V	99	08.91	06.94		1.8 Rsi (B/C 579)	80	01.93	08.95		1.8 Rsi (B/C 57H)	79	08.95	09.98		1.9 D	40	01.97	09.98	+ ABS	1.9 D	47	01.91	09.98	+ ABS	Williams (B/C 57M)	108	01.94	09.98																										
1.2 (B/C 57A/S)	43	05.90	09.98	+ ABS	G1020777						21597 11,0 +/S	BDX																																																																																																																						
1.2 (B/C 57R)	40	01.91	01.96	+ ABS																																																																																																																														
1.4	59	01.91	09.98	+ ABS																																																																																																																														
1.4 (B/C 57J)	55	01.91	09.98	+ ABS																																																																																																																														
1.4 (B/C 57T/Y)	58	01.91	09.98	+ ABS																																																																																																																														
1.7	68	12.93	04.95	+ ABS																																																																																																																														
1.8 (357A)	70	10.94	09.98	+ ABS																																																																																																																														
1.8 (357D)	70	10.94	04.96	+ ABS																																																																																																																														
1.8 (357E)	70	10.94	04.96																																																																																																																															
1.8 (557A)	70	08.94	09.98	+ ABS																																																																																																																														
1.8 (557D)	70	08.94	04.96	+ ABS																																																																																																																														
1.8 (557U)	70	09.96	09.98	+ ABS																																																																																																																														
1.8 (B/C 578)	66	08.94	09.98	+ ABS																																																																																																																														
1.8 (B/C 57C/U)	65	12.93	09.98	+ ABS																																																																																																																														
1.8 16V	99	08.91	06.94																																																																																																																															
1.8 Rsi (B/C 579)	80	01.93	08.95																																																																																																																															
1.8 Rsi (B/C 57H)	79	08.95	09.98																																																																																																																															
1.9 D	40	01.97	09.98	+ ABS																																																																																																																														
1.9 D	47	01.91	09.98	+ ABS																																																																																																																														
Williams (B/C 57M)	108	01.94	09.98																																																																																																																															
	<table border="1"> <tr><td>1.2</td><td>44</td><td>05.90</td><td>03.96</td><td>+ ABS</td><td rowspan="20">G2108109</td><td rowspan="20"></td><td rowspan="20">238 8,0 7,0 +C</td><td rowspan="20"></td></tr> <tr><td>1.2 (5/357F/J/L/R)</td><td>43</td><td>10.94</td><td>09.98</td><td>+ ABS</td></tr> <tr><td>1.2 (5/357K.5/357Y)</td><td>40</td><td>01.96</td><td>09.98</td><td>+ ABS</td></tr> <tr><td>1.2 (5/357K.5/357Y)</td><td>43</td><td>01.96</td><td>09.98</td><td>+ ABS</td></tr> <tr><td>1.2 (B/C 577)</td><td>40</td><td>01.96</td><td>12.96</td><td>+ ABS</td></tr> <tr><td>1.2 (B/C 57A/S)</td><td>43</td><td>05.90</td><td>09.98</td><td>+ ABS</td></tr> <tr><td>1.2 (B/C 57R)</td><td>40</td><td>01.91</td><td>01.96</td><td>+ ABS</td></tr> <tr><td>1.4</td><td>59</td><td>01.91</td><td>09.98</td><td>+ ABS</td></tr> <tr><td>1.4 (B/C 57J)</td><td>55</td><td>01.91</td><td>09.98</td><td>+ ABS</td></tr> <tr><td>1.4 (B/C 57T/Y)</td><td>58</td><td>01.91</td><td>09.98</td><td>+ ABS</td></tr> <tr><td>1.7</td><td>68</td><td>12.93</td><td>04.95</td><td>+ ABS</td></tr> <tr><td>1.8 (357A)</td><td>70</td><td>10.94</td><td>09.98</td><td>+ ABS</td></tr> <tr><td>1.8 (357D)</td><td>70</td><td>10.94</td><td>04.96</td><td>+ ABS</td></tr> <tr><td>1.8 (357E)</td><td>70</td><td>10.94</td><td>04.96</td><td></td></tr> <tr><td>1.8 (557A)</td><td>70</td><td>08.94</td><td>09.98</td><td>+ ABS</td></tr> <tr><td>1.8 (557D)</td><td>70</td><td>08.94</td><td>04.96</td><td>+ ABS</td></tr> <tr><td>1.8 (557U)</td><td>70</td><td>09.96</td><td>09.98</td><td>+ ABS</td></tr> <tr><td>1.8 (B/C 578)</td><td>66</td><td>08.94</td><td>09.98</td><td>+ ABS</td></tr> <tr><td>1.8 (B/C 57C/U)</td><td>65</td><td>12.93</td><td>09.98</td><td>+ ABS</td></tr> <tr><td>1.8 16V</td><td>99</td><td>08.91</td><td>06.94</td><td></td></tr> <tr><td>1.8 Rsi (B/C 579)</td><td>80</td><td>01.93</td><td>08.95</td><td></td></tr> <tr><td>1.8 Rsi (B/C 57H)</td><td>79</td><td>08.95</td><td>09.98</td><td></td></tr> <tr><td>1.9 D</td><td>40</td><td>01.97</td><td>09.98</td><td>+ ABS</td></tr> <tr><td>1.9 D</td><td>47</td><td>01.91</td><td>09.98</td><td>+ ABS</td></tr> <tr><td>Williams (B/C 57M)</td><td>108</td><td>01.94</td><td>09.98</td><td></td></tr> </table>	1.2	44	05.90	03.96	+ ABS	G2108109		238 8,0 7,0 +C		1.2 (5/357F/J/L/R)	43	10.94	09.98	+ ABS	1.2 (5/357K.5/357Y)	40	01.96	09.98	+ ABS	1.2 (5/357K.5/357Y)	43	01.96	09.98	+ ABS	1.2 (B/C 577)	40	01.96	12.96	+ ABS	1.2 (B/C 57A/S)	43	05.90	09.98	+ ABS	1.2 (B/C 57R)	40	01.91	01.96	+ ABS	1.4	59	01.91	09.98	+ ABS	1.4 (B/C 57J)	55	01.91	09.98	+ ABS	1.4 (B/C 57T/Y)	58	01.91	09.98	+ ABS	1.7	68	12.93	04.95	+ ABS	1.8 (357A)	70	10.94	09.98	+ ABS	1.8 (357D)	70	10.94	04.96	+ ABS	1.8 (357E)	70	10.94	04.96		1.8 (557A)	70	08.94	09.98	+ ABS	1.8 (557D)	70	08.94	04.96	+ ABS	1.8 (557U)	70	09.96	09.98	+ ABS	1.8 (B/C 578)	66	08.94	09.98	+ ABS	1.8 (B/C 57C/U)	65	12.93	09.98	+ ABS	1.8 16V	99	08.91	06.94		1.8 Rsi (B/C 579)	80	01.93	08.95		1.8 Rsi (B/C 57H)	79	08.95	09.98		1.9 D	40	01.97	09.98	+ ABS	1.9 D	47	01.91	09.98	+ ABS	Williams (B/C 57M)	108	01.94	09.98	
1.2	44	05.90	03.96	+ ABS	G2108109						238 8,0 7,0 +C																																																																																																																							
1.2 (5/357F/J/L/R)	43	10.94	09.98	+ ABS																																																																																																																														
1.2 (5/357K.5/357Y)	40	01.96	09.98	+ ABS																																																																																																																														
1.2 (5/357K.5/357Y)	43	01.96	09.98	+ ABS																																																																																																																														
1.2 (B/C 577)	40	01.96	12.96	+ ABS																																																																																																																														
1.2 (B/C 57A/S)	43	05.90	09.98	+ ABS																																																																																																																														
1.2 (B/C 57R)	40	01.91	01.96	+ ABS																																																																																																																														
1.4	59	01.91	09.98	+ ABS																																																																																																																														
1.4 (B/C 57J)	55	01.91	09.98	+ ABS																																																																																																																														
1.4 (B/C 57T/Y)	58	01.91	09.98	+ ABS																																																																																																																														
1.7	68	12.93	04.95	+ ABS																																																																																																																														
1.8 (357A)	70	10.94	09.98	+ ABS																																																																																																																														
1.8 (357D)	70	10.94	04.96	+ ABS																																																																																																																														
1.8 (357E)	70	10.94	04.96																																																																																																																															
1.8 (557A)	70	08.94	09.98	+ ABS																																																																																																																														
1.8 (557D)	70	08.94	04.96	+ ABS																																																																																																																														
1.8 (557U)	70	09.96	09.98	+ ABS																																																																																																																														
1.8 (B/C 578)	66	08.94	09.98	+ ABS																																																																																																																														
1.8 (B/C 57C/U)	65	12.93	09.98	+ ABS																																																																																																																														
1.8 16V	99	08.91	06.94																																																																																																																															
1.8 Rsi (B/C 579)	80	01.93	08.95																																																																																																																															
1.8 Rsi (B/C 57H)	79	08.95	09.98																																																																																																																															
1.9 D	40	01.97	09.98	+ ABS																																																																																																																														
1.9 D	47	01.91	09.98	+ ABS																																																																																																																														
Williams (B/C 57M)	108	01.94	09.98																																																																																																																															
RENAULT CLIO I Van (S 57_) (91-98)																																																																																																																																		
	<table border="1"> <tr><td>1.1</td><td>34</td><td>01.91</td><td>04.92</td><td></td><td rowspan="4">G1020219 G1020501</td><td rowspan="4"></td><td rowspan="4">21097 15,0 +/W/ 21463 18,2 /W/S</td><td rowspan="4">BDX LUC</td></tr> <tr><td>1.1</td><td>34</td><td>05.92</td><td>09.98</td><td></td></tr> <tr><td>1.2</td><td>40</td><td>01.91</td><td>09.98</td><td></td></tr> <tr><td>1.2</td><td>44</td><td>01.91</td><td>09.98</td><td></td></tr> <tr><td>1.9 D</td><td>48</td><td>01.91</td><td>09.98</td><td></td></tr> </table>	1.1	34	01.91	04.92		G1020219 G1020501		21097 15,0 +/W/ 21463 18,2 /W/S	BDX LUC	1.1	34	05.92	09.98		1.2	40	01.91	09.98		1.2	44	01.91	09.98		1.9 D	48	01.91	09.98																																																																																																					
1.1	34	01.91	04.92		G1020219 G1020501						21097 15,0 +/W/ 21463 18,2 /W/S	BDX LUC																																																																																																																						
1.1	34	05.92	09.98																																																																																																																															
1.2	40	01.91	09.98																																																																																																																															
1.2	44	01.91	09.98																																																																																																																															
1.9 D	48	01.91	09.98																																																																																																																															
	<table border="1"> <tr><td>1.1</td><td>34</td><td>01.91</td><td>04.92</td><td></td><td rowspan="4">G2108104</td><td rowspan="4"></td><td rowspan="4">238 8,2 7,0 +S +C</td><td rowspan="4"></td></tr> <tr><td>1.1</td><td>34</td><td>05.92</td><td>09.98</td><td></td></tr> <tr><td>1.2</td><td>40</td><td>01.91</td><td>09.98</td><td></td></tr> <tr><td>1.2</td><td>44</td><td>01.91</td><td>09.98</td><td></td></tr> <tr><td>1.9 D</td><td>48</td><td>01.91</td><td>01.94</td><td></td></tr> </table>	1.1	34	01.91	04.92		G2108104		238 8,2 7,0 +S +C		1.1	34	05.92	09.98		1.2	40	01.91	09.98		1.2	44	01.91	09.98		1.9 D	48	01.91	01.94																																																																																																					
1.1	34	01.91	04.92		G2108104						238 8,2 7,0 +S +C																																																																																																																							
1.1	34	05.92	09.98																																																																																																																															
1.2	40	01.91	09.98																																																																																																																															
1.2	44	01.91	09.98																																																																																																																															
1.9 D	48	01.91	01.94																																																																																																																															
	<table border="1"> <tr><td>1.2</td><td>40</td><td>01.91</td><td>09.98</td><td>+ ABS</td><td rowspan="3">G2120125</td><td rowspan="3"></td><td rowspan="3">238 20,1 17,7 V +S +C</td><td rowspan="3"></td></tr> <tr><td>1.2</td><td>44</td><td>01.91</td><td>09.98</td><td>+ ABS</td></tr> <tr><td>1.9 D</td><td>48</td><td>02.94</td><td>09.98</td><td></td></tr> </table>	1.2	40	01.91	09.98	+ ABS	G2120125		238 20,1 17,7 V +S +C		1.2	44	01.91	09.98	+ ABS	1.9 D	48	02.94	09.98																																																																																																															
1.2	40	01.91	09.98	+ ABS	G2120125						238 20,1 17,7 V +S +C																																																																																																																							
1.2	44	01.91	09.98	+ ABS																																																																																																																														
1.9 D	48	02.94	09.98																																																																																																																															
	<table border="1"> <tr><td>1.2</td><td>40</td><td>01.91</td><td>09.98</td><td>+ ABS</td><td rowspan="3">G1020777</td><td rowspan="3"></td><td rowspan="3">21597 11,0 +/S</td><td rowspan="3">BDX</td></tr> <tr><td>1.2</td><td>44</td><td>01.91</td><td>09.98</td><td>+ ABS</td></tr> <tr><td>1.9 D</td><td>48</td><td>01.91</td><td>09.98</td><td>+ ABS</td></tr> </table>	1.2	40	01.91	09.98	+ ABS	G1020777		21597 11,0 +/S	BDX	1.2	44	01.91	09.98	+ ABS	1.9 D	48	01.91	09.98	+ ABS																																																																																																														
1.2	40	01.91	09.98	+ ABS	G1020777						21597 11,0 +/S	BDX																																																																																																																						
1.2	44	01.91	09.98	+ ABS																																																																																																																														
1.9 D	48	01.91	09.98	+ ABS																																																																																																																														
	<table border="1"> <tr><td>1.2</td><td>44</td><td>01.91</td><td>09.98</td><td>+ ABS</td><td rowspan="3">G2108109</td><td rowspan="3"></td><td rowspan="3">238 8,0 7,0 +C</td><td rowspan="3"></td></tr> <tr><td>1.2</td><td>44</td><td>01.91</td><td>09.98</td><td>+ ABS</td></tr> <tr><td>1.9 D</td><td>48</td><td>01.91</td><td>09.98</td><td>+ ABS</td></tr> </table>	1.2	44	01.91	09.98	+ ABS	G2108109		238 8,0 7,0 +C		1.2	44	01.91	09.98	+ ABS	1.9 D	48	01.91	09.98	+ ABS																																																																																																														
1.2	44	01.91	09.98	+ ABS	G2108109						238 8,0 7,0 +C																																																																																																																							
1.2	44	01.91	09.98	+ ABS																																																																																																																														
1.9 D	48	01.91	09.98	+ ABS																																																																																																																														
RENAULT CLIO II Saloon (BB_/CB_) (98-12)																																																																																																																																		
	<table border="1"> <tr><td>1.0</td><td>40</td><td>02.00</td><td>05.01</td><td></td><td rowspan="20">G1020501</td><td rowspan="20"></td><td rowspan="20">21463 18,2 /W/S</td><td rowspan="20">LUC</td></tr> <tr><td>1.2</td><td>43</td><td>09.98</td><td>12.12</td><td></td></tr> <tr><td>1.2</td><td>44</td><td>03.99</td><td>05.01</td><td></td></tr> <tr><td>1.2 16V</td><td>55</td><td>06.01</td><td>12.12</td><td></td></tr> <tr><td>1.4</td><td>55</td><td>09.98</td><td>05.05</td><td></td></tr> <tr><td>1.4 16V</td><td>70</td><td>10.99</td><td>07.00</td><td></td></tr> <tr><td>1.4 16V</td><td>72</td><td>08.00</td><td>12.12</td><td></td></tr> <tr><td>1.5 dCi</td><td>47</td><td>06.05</td><td>12.12</td><td></td></tr> <tr><td>1.5 dCi</td><td>48</td><td>06.01</td><td>12.12</td><td></td></tr> <tr><td>1.5 dCi</td><td>50</td><td>08.04</td><td>12.12</td><td></td></tr> <tr><td>1.5 dCi</td><td>59</td><td>06.01</td><td>10.03</td><td></td></tr> <tr><td>1.5 dCi</td><td>60</td><td>06.01</td><td>12.12</td><td></td></tr> <tr><td>1.5 dCi</td><td>62</td><td>02.07</td><td>12.12</td><td></td></tr> <tr><td>1.5 dCi</td><td>74</td><td>01.04</td><td>12.12</td><td></td></tr> <tr><td>1.6</td><td>66</td><td>09.98</td><td>05.05</td><td></td></tr> <tr><td>1.6 16V</td><td>79</td><td>09.98</td><td>12.12</td><td></td></tr> <tr><td>1.9 D</td><td>47</td><td>09.98</td><td>05.05</td><td></td></tr> <tr><td>1.9 D</td><td>48</td><td>02.00</td><td>05.05</td><td></td></tr> <tr><td>1.9 dTi</td><td>59</td><td>02.00</td><td>05.05</td><td></td></tr> </table>	1.0	40	02.00	05.01		G1020501		21463 18,2 /W/S	LUC	1.2	43	09.98	12.12		1.2	44	03.99	05.01		1.2 16V	55	06.01	12.12		1.4	55	09.98	05.05		1.4 16V	70	10.99	07.00		1.4 16V	72	08.00	12.12		1.5 dCi	47	06.05	12.12		1.5 dCi	48	06.01	12.12		1.5 dCi	50	08.04	12.12		1.5 dCi	59	06.01	10.03		1.5 dCi	60	06.01	12.12		1.5 dCi	62	02.07	12.12		1.5 dCi	74	01.04	12.12		1.6	66	09.98	05.05		1.6 16V	79	09.98	12.12		1.9 D	47	09.98	05.05		1.9 D	48	02.00	05.05		1.9 dTi	59	02.00	05.05																															
1.0	40	02.00	05.01		G1020501						21463 18,2 /W/S	LUC																																																																																																																						
1.2	43	09.98	12.12																																																																																																																															
1.2	44	03.99	05.01																																																																																																																															
1.2 16V	55	06.01	12.12																																																																																																																															
1.4	55	09.98	05.05																																																																																																																															
1.4 16V	70	10.99	07.00																																																																																																																															
1.4 16V	72	08.00	12.12																																																																																																																															
1.5 dCi	47	06.05	12.12																																																																																																																															
1.5 dCi	48	06.01	12.12																																																																																																																															
1.5 dCi	50	08.04	12.12																																																																																																																															
1.5 dCi	59	06.01	10.03																																																																																																																															
1.5 dCi	60	06.01	12.12																																																																																																																															
1.5 dCi	62	02.07	12.12																																																																																																																															
1.5 dCi	74	01.04	12.12																																																																																																																															
1.6	66	09.98	05.05																																																																																																																															
1.6 16V	79	09.98	12.12																																																																																																																															
1.9 D	47	09.98	05.05																																																																																																																															
1.9 D	48	02.00	05.05																																																																																																																															
1.9 dTi	59	02.00	05.05																																																																																																																															



### RENAULT CLIO II Saloon (BB /CB\_) (98-12)

	2.0 16V Sport 2.0 16V Sport	124 132		02.00 01.04	12.12 12.12		G1020569		23172 18,0 /WD/Acc/S	LUC
	1.0 1.2 1.2 1.2 16V 1.4 1.4 1.5 dCi 1.5 dCi 1.9 D 1.9 D	40 43 44 55 55 55 47 62 47 48		02.00 09.98 03.99 06.01 09.98 09.98 06.05 02.07 09.98 02.00	05.01 05.01 05.01 02.10 05.05 05.05 02.08 12.12 05.05 05.05	- ABS - ABS - ABS - ABS - ABS/ + manual transmission <sup>1)</sup> - ABS - ABS - ABS - ABS/ - air conditioning <sup>2)</sup> - ABS/ - air conditioning <sup>2)</sup>	G2112116		238 12,0 10,5 +S +C	
	1.0 1.2 1.2 1.2 16V 1.4 1.4 1.4 1.4 16V 1.4 16V 1.5 dCi 1.5 dCi 1.6	40 43 44 55 55 55 70 72 47 62 66		02.00 09.98 03.99 06.01 09.98 09.98 09.98 10.99 08.00 06.05 02.07 09.98	05.01 05.01 05.01 12.12 05.05 05.05 05.05 07.00 12.12 02.08 12.12 05.05	+ ABS + ABS + ABS + ABS + ABS/ + manual transm. <sup>3)</sup> - ABS/ + autom.transmission <sup>4)</sup> + ABS - ABS + ABS + ABS - ABS	G2120125		238 20,1 17,7 V +S +C	
	1.0 1.2 1.2 16V 1.4 1.4 1.4 16V 1.4 16V 1.5 dCi 1.5 dCi 1.5 dCi 1.5 dCi 1.5 dCi 1.6 1.6 16V 1.9 dTi	40 43 55 55 70 72 48 50 59 60 74 66 79 59		02.00 06.01 06.01 09.98 10.99 08.00 06.01 08.04 06.01 06.01 01.04 09.98 09.98 02.00	05.01 12.12 12.12 05.05 07.00 12.12 12.12 12.12 10.03 12.12 12.12 05.05 12.12 05.05	+ ABS + ABS + ABS + ABS/ + autom.transmission <sup>5)</sup> + ABS + ABS + ABS + ABS + ABS + ABS	G2121106		259 20,6 17,7 V +S +C	
	1.9 D 1.9 D	47 48		09.98 02.00	05.05 05.05		G2120125 G2121106	+ ABS/ - air conditioning <sup>6)</sup> + ABS/ + air conditioning <sup>7)</sup>	238 20,1 17,7 V +S +C 259 20,6 17,7 V +S +C	
	2.0 16V Sport 2.0 16V Sport	124 132		02.00 01.04	12.12 12.12		G2124158		280 24,0 21,8 V L +S +C	
	1.2 1.2 16V 1.4 16V 1.5 dCi 1.5 dCi 1.5 dCi 1.5 dCi 1.5 dCi 1.5 dCi 2.0 16V Sport 2.0 16V Sport	43 55 72 48 50 59 60 62 74 124 132		09.98 06.01 08.00 06.01 08.04 06.01 06.01 02.07 01.04 02.00 01.04	12.12 12.12 12.12 12.12 12.12 10.03 12.12 12.12 12.12 12.12 12.12	+ ABS + ABS + ABS + ABS + ABS + ABS + ABS + ABS + ABS	G1020522		20974 10,7	BDX
	1.4 16V 1.5 dCi 2.0 16V Sport 2.0 16V Sport	72 59 124 132		12.02 12.02 02.00 01.04	12.12 10.03 12.12 12.12	+ ESP + ESP	G2108108	without sensor ring <sup>8)</sup>	238 8,0 7,0 +C	

### RENAULT CLIO II Van (SB\_) (98-12)

	1.2 1.2 1.5 dCi 1.5 dCi 1.5 dCi 1.9 D 1.9 D 1.9 D (SB) 1.9 dTi	43 44 48 59 60 40 47 48 59		09.98 03.99 06.01 06.01 11.03 03.99 09.98 02.00 02.00	12.12 10.03 12.12 10.04 12.12 01.00 12.12 05.01 05.01		G1020501		21463 18,2 /W/S	LUC
	1.2 1.2	43 44		09.98 03.99	12.12 10.03	- ABS - ABS	G2112116		238 12,0 10,5 +S +C	
	1.2 1.9 D 1.9 D 1.9 D (SB)	43 40 47 48		09.98 03.99 09.98 02.00	12.12 01.00 12.12 05.01	+ ABS  - ABS	G2120125		238 20,1 17,7 V +S +C	
	1.5 dCi 1.5 dCi 1.5 dCi 1.9 D (SB) 1.9 dTi	48 59 60 48 59		06.01 06.01 11.03 02.00 02.00	12.12 10.04 12.12 05.01 05.01	+ ABS + ABS + ABS + ABS	G2121106		259 20,6 17,7 V +S +C	

<sup>1)</sup> - ABS/ + scatola camb.velocità / - ABS/ + transmission mécanique / - ABS/ + cambio de velocidad / - ABS/ + Schaltgetriebe

<sup>2)</sup> - ABS/ - aria condizionata / - ABS/ - air conditionné / - ABS/ - aire acondicionado / - ABS/ - Klimaanlage

<sup>3)</sup> + ABS/ + scatola camb.velocità / + ABS/ + transmission mécanique / + ABS/ + cambio de velocidad / + ABS/ + Schaltgetriebe

<sup>4)</sup> - ABS/ + scatola cambio autom. / - ABS/ + transmission automatique / - ABS/ + cambio automático / - ABS/ + Automatikgetriebe

<sup>5)</sup> + ABS/ + scatola cambio autom. / + ABS/ + transmission automatique / + ABS/ + cambio automático / + ABS/ + Automatikgetriebe

<sup>6)</sup> + ABS/ - aria condizionata / + ABS/ - air conditionné / + ABS/ - aire acondicionado / + ABS/ - Klimaanlage

<sup>7)</sup> + ABS/ + aria condizionata / + ABS/ + air conditionné / + ABS/ + aire acondicionado / + ABS/ + Klimaanlage

<sup>8)</sup> senza sensori / sans secours ABS / sin anillo sensor ABS / ohne Sensoring























**RENAULT CLIO III (BR\_/CR\_) (05-12)**

	1.2 16V	48		06.05	12.12	G1020741		23973 17,1 /Acc/S	LUC
	1.2 16V	55		06.05	12.12				
	1.2 16V	58		06.05	12.12				
	1.2 16V	74		05.07	12.12				
	1.2 16V	76		09.10	12.12				
	1.2 16V Hi-Flex	55		07.08	12.12				
	1.4 16V	72		06.05	12.12				
	1.5 dCi	47		06.05	12.12				
	1.5 dCi	48		05.05	10.06				
	1.5 dCi	50		06.05	12.12				
	1.5 dCi	55		08.10	12.12				
	1.5 dCi	63		06.05	12.12				
	1.5 dCi	65		08.10	12.12				
	1.5 dCi	76		06.05	12.12				
	1.5 dCi	78		06.05	12.12				
	1.6 16V	65		06.05	12.12				
	1.6 16V	82		06.05	12.12				
1.6 16V GT	94		04.09	12.12					
	2.0 16V	102		09.06	12.12	G1020871		24535 18,3 +	ATE
	2.0 16V	110		11.07	12.12				
	1.2 16V	48		06.05	12.12	G2122216		260 22,0 19,8 V L +S +C	
	1.2 16V	55		06.05	12.12				
	1.2 16V	58		06.05	12.12				
	1.2 16V	74		05.07	12.12				
	1.2 16V	76		09.10	12.12				
	1.2 16V Hi-Flex	55		07.08	12.12				
	1.4 16V	72		06.05	12.12				
	1.5 dCi	47		06.05	12.12				
	1.5 dCi	48		05.05	10.06				
	1.5 dCi	50		06.05	12.12				
	1.5 dCi	55		08.10	12.12				
	1.5 dCi	63		06.05	12.12				
	1.5 dCi	65		08.10	12.12				
	1.5 dCi	76		06.05	12.12				
	1.5 dCi	78		06.05	12.12				
	1.6 16V	65		06.05	12.12				
	1.6 16V	82		06.05	12.12				
1.6 16V GT	94		04.09	12.12					
	2.0 16V	102		09.06	12.12	G2124158		280 24,0 21,8 V L +S +C	
	2.0 16V	110		11.07	12.12				
	1.2 16V	48		06.05	12.12 + ESP	G1020489		23554 16,3 /WD/Acc/S	LUC
	1.2 16V	55		06.05	12.12 + ESP				
	1.2 16V	58		06.05	12.12 + ESP				
	1.2 16V	74		05.07	12.12 + ESP				
	1.2 16V	76		09.10	12.12 + ESP				
	1.2 16V Hi-Flex	55		07.08	12.12 + ESP				
	1.4 16V	72		06.05	12.12 + ESP				
	1.5 dCi	48		05.05	10.06 + ESP				
	1.5 dCi	50		06.05	12.12 + ESP				
	1.5 dCi	55		08.10	12.12 + ESP				
	1.5 dCi	63		06.05	12.12 + ESP				
	1.5 dCi	65		08.10	12.12 + ESP				
	1.5 dCi	76		06.05	12.12 + ESP				
	1.5 dCi	78		06.05	12.12				
	1.6 16V	65		06.05	12.12				
	1.6 16V	82		06.05	12.12				
	1.6 16V GT	94		04.09	12.12				
2.0 16V	102		09.06	12.12					

**RENAULT CLIO III Grandtour (KR\_) (08-12)**

	1.2 16V	55		02.08	12.12	G1020741		23973 17,1 /Acc/S	LUC
	1.2 16V	57		02.08	12.12				
	1.2 16V	74		02.08	12.12				
	1.2 16V Hi-Flex	55		07.08	12.12				
	1.4 16V	72		02.10	12.12				
	1.5 dCi	48		02.08	12.12				
	1.5 dCi	50		02.08	12.12				
	1.5 dCi	63		02.08	12.12				
	1.5 dCi	76		02.08	12.12				
	1.5 dCi	78		02.08	12.12				
	1.6 16V	82		02.08	12.12				
1.6 16V	94		11.08	12.12					
	1.2 16V	55		02.08	12.12	G2122216		260 22,0 19,8 V L +S +C	
	1.2 16V	57		02.08	12.12				
	1.2 16V	74		02.08	12.12				
	1.2 16V Hi-Flex	55		07.08	12.12				
	1.4 16V	72		02.10	12.12				
	1.5 dCi	48		02.08	12.12				
	1.5 dCi	50		02.08	12.12				
	1.5 dCi	63		02.08	12.12				
	1.5 dCi	76		02.08	12.12				
	1.5 dCi	78		02.08	12.12				
	1.6 16V	82		02.08	12.12				
1.6 16V	94		11.08	12.12					

									
<b>RENAULT CLIO III Grandtour (KR_) (08-12)</b>									
	1.2 16V	55	02.08	12.12	+ ESP	G1020489	23554 16,3 /WD/Acc/S	LUC	
	1.2 16V	57	02.08	12.12	+ ESP				
	1.2 16V	74	02.08	12.12	+ ESP				
	1.2 16V Hi-Flex	55	07.08	12.12	+ ESP				
	1.4 16V	72	02.10	12.12	+ ESP				
	1.5 dCi	48	02.08	12.12	+ ESP				
	1.5 dCi	50	02.08	12.12	+ ESP				
	1.5 dCi	63	02.08	12.12	+ ESP				
	1.5 dCi	76	02.08	12.12	+ ESP				
	1.5 dCi	78	02.08	12.12	+ ESP				
	1.6 16V	82	02.08	12.12	+ ESP				
	1.6 16V	94	11.08	12.12	+ ESP				
<b>RENAULT CLIO IV (B98_) (12-)</b>									
	0.9 TCe 90	66	09.12			G1020741	+ 17" wheel <sup>1)</sup>	23973 17,1 /Acc/S	LUC
	1.2 16V 75	54	09.12						
	1.5 dCi 75	55	09.12						
	1.5 dCi 90	66	09.12						
	1.2 TCe 120	88	03.13			G1020741		23973 17,1 /Acc/S	LUC
<b>RENAULT CLIO IV Grandtour (K98_) (12-)</b>									
	0.9 TCe 90	66	11.12			G1020741		23973 17,1 /Acc/S	LUC
	1.2 16V	54	11.12						
	1.2 TCe 120	88	03.13						
	1.5 dCi 75	55	11.12						
	1.5 dCi 90	66	11.12						
<b>RENAULT DOKKER (K67/F67) (12-)</b>									
	1.5 dCi 75	55	11.12		- ESP	G1020741		23973 17,1 /Acc/S	LUC
	1.5 dCi 90	66	11.12		- ESP				
	1.6 MPI	61	11.12		- ESP				
	1.2 TCe 115	85	01.13			G1201126		24538 17,9 +	ATE
	1.5 dCi 75	55	11.12		+ ESP				
	1.5 dCi 90	66	11.12		+ ESP				
	1.6 MPI	61	11.12		+ ESP				
	1.5 dCi 75	55	11.12		- ESP	G2122270	- increased payload <sup>2)</sup>	258 22,0 19,8 V L +S +C	
	1.5 dCi 90	66	11.12		- ESP				
	1.6 MPI	61	11.12		- ESP				
<b>RENAULT DUSTER (HS-) (11-)</b>									
	1.5 dCi	66	06.11		- ABS	G1020741		23973 17,1 /Acc/S	LUC
	1.6 16V	75	06.11		- ESP				
	1.6 16V 4x4	75	06.11		- ESP				
	2.0	98	02.12		- ABS				
	1.5 dCi 4x4	66	06.11			G1201126		24538 17,9 +	ATE
	1.5 dCi	66	06.11		+ ABS	G2124221		280 24,0 21,8 V L +S +C	
	1.5 dCi 4x4	66	06.11						
	1.6 16V	75	06.11		+ ESP				
	1.6 16V 4x4	75	06.11		+ ESP				
	2.0	98	02.12		+ ABS				
	2.0 4x4	98	02.12						
<b>RENAULT ESPACE II (J/S 63_) (91-96)</b>									
	2.8 V6 (J638,J63J)	110	01.91	10.96		G1020326		21388 18,0 +/W/S	LUC
<b>RENAULT ESPACE III (JE_) (96-02)</b>									
	1.9 dTi	72	02.99	10.02		G1020459		21888 18,1 +/W/S	LUC
	2.0	84	11.96	10.00					
	2.0	102	09.01	10.02					
	2.0 16V	103	10.98	10.02					
	2.2 D	84	11.97	01.00					
	2.2 dT	83	11.96	10.00					
	3.0 V6	123	11.96	10.98					
	2.2 dCi	85	07.00	10.02		G1020633		23099 18,4 /S	LUC
	2.2 dCi	95	10.00	10.02					
	3.0 V6	140	07.00	10.02					
	1.9 dTi	72	02.99	10.02		G2124171		280 24,0 21,8 V L +S +C	
	2.0	84	11.96	10.00					
	2.0	102	09.01	10.02					
	2.0 16V	103	10.98	10.02					
	2.2 D	84	11.97	01.00					
	2.2 dT	83	11.96	10.00					
	3.0 V6	123	11.96	10.98					
	2.0 16V	103	10.98	06.00		G1020327		20410 15,0 +	BRE
	3.0 V6	123	11.96	10.98					
	3.0 V6	140	10.98	06.00					
	2.0	102	09.01	10.02		G1020489		23554 16,3 /WD/Acc/S	LUC
	2.0 16V	103	07.00	10.02					
	2.2 dCi	95	10.00	10.02					
	3.0 V6	140	07.00	10.02					

<sup>1)</sup> + ruota 17" / + roue 17" / + rueda 17" / + 17" Rad

<sup>2)</sup> - carico utile maggiorato / - charge utile augmentée / - incremento de carga / - erhöhte Zuladung



**RENAULT ESPACE IV (JK\_) (02-)**

	1.9 dCi	85		04.03	02.05	G1020548		23248 18,3 +	ATE
	1.9 dCi	88		11.02					
	2.0	98		11.02	02.05				
	2.0 dCi	96		01.06					
	2.0 dCi 110	110		01.06					
	2.0 dCi 130	127		01.06					
	2.0 i	100		11.02					
	2.0 Turbo	120		11.02					
	2.0 Turbo	125		04.05					
	2.2 dCi	102		02.06					
	2.2 dCi	110		11.02					
	3.0 dCi	130		11.02					
3.0 dCi	133		01.06						
3.5 V6	177		11.02						

**RENAULT EXPRESS/RAPID (F40\_) (85-98)**

	1.0 (F400)	27		01.86	05.88	G1020219		21097 15,0 +/WI	BDX				
	1.1 (F401)	33		07.85	05.88 - (i)								
	1.1 (F40H)	33		06.87	05.88								
	1.6 (F404)	40		01.86	06.86 + (f)								
	1.0 (F400)	27		06.88	05.92					G1020214 G1020501		20905 18,0 +/WI 21463 18,2 /WI/S	BDX LUC
	1.1 (F401)	33		06.88	04.95								
	1.1 (F401)	33		07.85	05.88 + (i)								
	1.1 (F40H)	33		06.88	06.90								
	1.1 (F40T)	33		09.91	03.98								
	1.2 (F406)	40		10.92	03.98								
1.2 (F40F)	40		06.90	03.98									
1.4 (F402)	43		01.86	06.90									
1.4 (F40A)	43		06.90	03.98									
1.4 (F40M)	44		06.87	06.90									
1.4 (F40Y)	43		09.91	03.98									
1.4 i (F407)	43		01.86	03.98									
1.4 i (F40D)	58		09.94	03.98									
1.4 i (F40U)	55		09.91	03.98									
1.4 i (F40V)	55		09.91	03.98									
1.6 (F404)	40		07.86	08.98 + (f)									
1.6 (F404)	40		01.86	08.98 - (f)									
1.9 (F40E)	47		09.92	03.98									
1.9 (F40N)	47		06.90	03.98									
1.9 (F40P)	47		09.91	03.98									
1.9 (F40R)	40		09.94	03.98	G1020214		20905 18,0 +/WI	BDX					
1.9 D (G40B)	40		09.95	03.98									
1.9 D (G40C)	40		09.95	03.98									
	1.0 (F400)	27		01.86	05.92 + (b)	G2108104		238 8,2 7,0 +S +C					
	1.1 (F401)	33		07.85	05.88 - (i)								
	1.1 (F40H)	33		06.87	05.88								
	1.6 (F404)	40		01.86	06.86 + (f)								
	1.0 (F400)	27		01.86	05.92 - (b)					G2112116		238 12,0 10,5 +S +C	
	1.1 (F401)	33		01.86	04.95 + (i)								
	1.1 (F401)	33		06.88	04.95 - (i)								
	1.1 (F40H)	33		06.88	06.90								
	1.1 (F40T)	33		09.91	03.98								
	1.2 (F406)	40		10.92	03.98								
1.2 (F40F)	40		06.90	03.98									
1.4 (F402)	43		01.86	06.90									
1.4 (F40A)	43		06.90	03.98									
1.4 (F40M)	44		06.87	06.90									
1.4 (F40Y)	43		09.91	03.98									
1.4 i (F407)	43		01.86	03.98									
1.4 i (F40D)	58		09.94	03.98									
1.4 i (F40U)	55		09.91	03.98									
1.4 i (F40V)	55		09.91	03.98									
1.6 (F404)	40		07.86	08.98 + (f)									
1.6 (F404)	40		01.86	08.98 - (f)									
1.9 (F40E)	47		09.92	03.98									
1.9 (F40N)	47		06.90	03.98									
1.9 (F40P)	47		09.91	03.98									
1.9 (F40R)	40		09.94	03.98									
1.9 D (G40B)	40		09.95	03.98									
1.9 D (G40C)	40		09.95	03.98									

<b>RENAULT FLUENCE (L30_) (10-)</b>															
	1.5 dCi	63		02.10	06.13	G1201126			24538 17,9 +	ATE					
	1.5 dCi	66		02.10	06.13										
	1.5 dCi	78		02.10	06.13										
	1.5 dCi	81		02.10	06.13										
	1.6 16V	81		02.10	06.13										
	1.6 16V	82		02.10	06.13										
	2.0 16V	101		05.11	06.13										
	2.0 16V	103		02.10	06.13										
Z.E.	70		02.12												
	1.5 dCi	63		02.10	06.13	G2124221			280 24,0 21,8 V L +S +C						
	1.5 dCi	66		02.10	06.13										
	1.5 dCi	78		02.10	06.13										
	1.5 dCi	81		02.10	06.13										
	1.6 16V	81		02.10	06.13										
	1.6 16V	82		02.10	06.13										
	2.0 16V	101		05.11	06.13										
	2.0 16V	103		02.10	06.13										
Z.E.	70		02.12												
	1.5 dCi	63		02.10	06.13	G1020920			23554 16,8 /WD/Acc/S	LUC					
	1.5 dCi	66		02.10	06.13										
	1.5 dCi	78		02.10	06.13										
	1.5 dCi	81		02.10	06.13										
	1.6 16V	81		02.10	06.13										
	1.6 16V	82		02.10	06.13										
	2.0 16V	103		02.10	06.13										
				02.10	06.13										
<b>RENAULT KANGOO I (KC_) (98-07)</b>															
	1.2	43		03.98	12.07	G1020497		- Postal vehicle <sup>1)</sup>	21980 18,0 +/WD/S	BOS					
	1.2 16V	55		06.01	12.07										
	1.4	55		03.98	12.07										
	1.5 dCi	42		07.03	12.07										
	1.5 dCi	45		04.05	12.07										
	1.5 dCi	62		06.05	12.07										
	1.5 dCi (KC07)	48		12.01	12.07										
	1.5 dCi (KC08/09)	60		07.02	12.07										
	1.6 16V 2WD	70		06.01	12.07										
	1.6 16V bivalent	60		06.05	12.07										
	1.9 D	47		03.98	12.07										
	1.9 D (KC0D)	40		03.98	12.07										
	1.9 dTi (KCOU)	59		02.00	12.07										
	1.9 RXED	48		09.99	06.01										
	electronic vehicle	22		01.02	12.04										
	1.6 16V 4x4	70		10.01	12.07						G1020685			23930 18,2 /Acc/S	BOS
1.9 dCi 4x4 (KCOV)	59		10.01	12.07											
	1.2	43		03.98	12.07	G2120125			238 20,1 17,7 V +S +C						
	1.2 16V	55		06.01	12.07						- ABS				
	1.4	55		03.98	12.07						- ABS/ - reinforced suspension <sup>2)</sup>				
	1.5 dCi	45		04.05	12.07						- ABS/ - reinforced suspension <sup>2)</sup>				
	1.9 D	47		03.98	12.07						- ABS				
	1.9 D (KC0D)	40		03.98	12.07						- ABS				
	1.9 dTi (KCOU)	59		02.00	12.07						- ABS				
	1.9 RXED	48		09.99	06.01						- ABS				
	electronic vehicle	22		01.02	12.04										
	1.2	43		03.98	12.07						+ ABS	G2121106		259 20,6 17,7 V +S +C	
	1.2 16V	55		06.01	12.07						+ ABS/ + reinforced suspens. <sup>3)</sup>				
	1.4	55		03.98	12.07						+ ABS/ + reinforced suspens. <sup>3)</sup>				
	1.5 dCi	42		07.03	12.07										
	1.5 dCi	45		04.05	12.07						+ ABS				
	1.5 dCi	62		06.05	12.07										
	1.5 dCi (KC07)	48		12.01	12.07										
1.5 dCi (KC08/09)	60		07.02	12.07											
1.6 16V 2WD	70		06.01	12.07											
1.6 16V bivalent	60		06.05	12.07											
1.9 D	47		03.98	12.07	+ ABS										
1.9 D (KC0D)	40		03.98	12.07	+ ABS										
1.9 dTi (KCOU)	59		02.00	12.07	+ ABS										
1.9 RXED	48		09.99	06.01	+ ABS										
1.6 16V 4x4	70		10.01	12.07		G2124158		280 24,0 21,8 V L +S +C							
1.9 dCi 4x4 (KCOV)	59		10.01	12.07											
	1.6 16V 4x4	70		10.01	12.07	G1020563			23557 17,2 /S	BOS					
	1.9 dCi 4x4 (KCOV)	59		10.01	12.07										
<b>RENAULT KANGOO II (KW_) (08-)</b>															
	1.2 TCe 115	84		05.13		G1020875		+ brake disc 258mm <sup>4)</sup>	24693 18,5 /Acc/S	LUC					
	1.5 dCi	50		02.08							G1020876	+ brake disc 280mm <sup>5)</sup>	24693 17,5 /Acc/S	LUC	
	1.5 dCi	63		02.08											
	1.5 dCi	76		02.08											
	1.5 dCi 110	80		09.10											
	1.5 dCi 75	55		11.12											
	1.5 dCi 90	66		11.12											
	1.6	64		02.08											
	1.6 16V	78		02.08											
	1.6 16V Hi-Flex	78		02.08											

<sup>1)</sup> - Veicoli postali / - Véhicule postal / - Vehículo de correos / - Postfahrzeug

<sup>2)</sup> - ABS/ - sospensione rinforzata / - ABS/ - châssis renforcé / - ABS/ - suspensión reforzada / - ABS/ - verstärktes Fahrwerk

<sup>3)</sup> + ABS/ + sospensione rinforzata / + ABS/ + châssis renforcé / + ABS/ + suspensión reforzada / + ABS/ + verstärktes Fahrwerk

<sup>4)</sup> + dischi freno 258mm / + disques de frein 258mm / + disco de freno 258mm / + Bremsscheibe 258mm

<sup>5)</sup> + dischi freno 280mm / + disques de frein 280mm / + disco de freno 280mm / + Bremsscheibe 280mm

### RENAULT KANGOO II (KW\_) (08-)

	1.2 TCe 115	84	05.13		G2122270	+ short wheel base <sup>1)</sup>	258 22,0 19,8 V L +S +C
	1.5 dCi	50	02.08				
	1.5 dCi	63	02.08				
	1.5 dCi	76	02.08				
	1.5 dCi 110	80	09.10				
	1.5 dCi 75	55	11.12				
	1.5 dCi 90	66	11.12				
	1.6	64	02.08				
	1.6 16V	78	02.08				
	1.6 16V Hi-Flex	78	02.08				
	1.2 TCe 115	84	05.13		G2124222	+ long wheel base <sup>2)</sup>	280 24,0 21,8 V L +S +C
	1.5 dCi	50	02.08				
	1.5 dCi	63	02.08				
1.5 dCi	76	02.08					
1.5 dCi 110	80	06.09					
1.5 dCi 75	55	11.12					
1.5 dCi 90	66	11.12					
1.6	64	02.08					
1.6 16V	78	02.08					
1.6 16V Hi-Flex	78	02.08					
	1.2 TCe 115	84	05.13		G1020874		24692 15,9 /Acc/S LUC
	1.5 dCi	50	02.08				
	1.5 dCi	63	02.08				
	1.5 dCi	76	02.08				
	1.5 dCi 110	80	09.10				
	1.5 dCi 75	55	11.12				
	1.5 dCi 90	66	11.12				
	1.6	64	02.08				
	1.6 16V	78	02.08				
	1.6 16V Hi-Flex	78	02.08				

### RENAULT KANGOO Be Bop (KWO\_) (09-10)

	1.5 dCi	55	09.10	12.10 + 14" wheel <sup>3)</sup>	G1020741		23973 17,1 /Acc/S LUC	
	1.5 dCi	66	06.09	12.10 + 14" wheel <sup>3)</sup>				
	1.5 dCi	76	02.09	12.10 + 14" wheel <sup>3)</sup>				
	1.5 dCi	80	06.09	12.10 + 14" wheel <sup>3)</sup>				
	1.6 16V	78	02.09	12.10 + 14" wheel <sup>3)</sup>				
	1.5 dCi	55	09.10	12.10 + 15"/16" wheel <sup>4)</sup>	G1020875	+ brake disc 258mm <sup>5)</sup>	24693 18,5 /Acc/S LUC	
	1.5 dCi	66	06.09	12.10 + 15"/16" wheel <sup>4)</sup>	G1020876	+ brake disc 280mm <sup>6)</sup>	24693 17,5 /Acc/S LUC	
	1.5 dCi	76	02.09	12.10 + 15"/16" wheel <sup>4)</sup>				
	1.5 dCi	80	06.09	12.10 + 15"/16" wheel <sup>4)</sup>				
	1.6 16V	78	02.09	12.10 + 15"/16" wheel <sup>4)</sup>				
	1.5 dCi	55	09.10	12.10 + 14" wheel <sup>3)</sup>	G2122270		258 22,0 19,8 V L +S +C	
	1.5 dCi	66	06.09	12.10 + 14" wheel <sup>3)</sup>				
	1.5 dCi	76	02.09	12.10 + 14" wheel <sup>3)</sup>				
	1.5 dCi	80	06.09	12.10 + 14" wheel <sup>3)</sup>				
	1.6 16V	78	02.09	12.10 + 14" wheel <sup>3)</sup>				
	1.5 dCi	55	09.10	12.10 + 15"/16" wheel <sup>4)</sup>	G2124222		280 24,0 21,8 V L +S +C	
	1.5 dCi	66	06.09	12.10 + 15"/16" wheel <sup>4)</sup>				
	1.5 dCi	76	02.09	12.10 + 15"/16" wheel <sup>4)</sup>				
	1.5 dCi	80	06.09	12.10 + 15"/16" wheel <sup>4)</sup>				
1.6 16V	78	02.09	12.10 + 15"/16" wheel <sup>4)</sup>					
	1.5 dCi	55	09.10	12.10 + 15"/16" wheel <sup>4)</sup>	G1020874		24692 15,9 /Acc/S LUC	
	1.5 dCi	66	06.09	12.10 + 15"/16" wheel <sup>4)</sup>				
	1.5 dCi	76	02.09	12.10 + 15"/16" wheel <sup>4)</sup>				
	1.5 dCi	80	06.09	12.10 + 15"/16" wheel <sup>4)</sup>				
	1.6 16V	78	02.09	12.10 + 15"/16" wheel <sup>4)</sup>				

### RENAULT KANGOO Express/Rapid (FC\_) (98-07)

	1.0	40	07.03	12.07	G1020497		21980 18,0 +WD/S BOS
	1.2	43	03.98	12.07			
	1.2	44	07.98	07.01			
	1.2 16V	55	10.01	12.07			
	1.4	55	03.98	12.07			
	1.5 dCi	42	12.02	12.07			
	1.5 dCi	50	06.05	12.07			
	1.5 dCi	62	06.05	12.07			
	1.5 dCi (FC07)	48	12.01	12.07			
	1.5 dCi (FC08/09)	60	04.03	12.07			
	1.6 16V	70	10.01	12.07			
	1.9 D	47	03.98	12.07			
	1.9 D	48	09.99	06.03			
	1.9 D (FC0D)	40	03.98	12.07			
	1.9 dTi (FC0U)	59	02.00	12.07			
	1.6 16V 4x4	70	10.01	12.07	G1020685		23930 18,2 /Acc/S BOS
1.9 dCi 4x4 (FC0V)	59	10.01	12.07				
	1.0	40	07.03	12.07 - ABS	G2120125		238 20,1 17,7 V +S +C
	1.2	43	03.98	12.07 - ABS			
	1.2	44	07.98	07.01 - ABS			
	1.4	55	03.98	12.07 - ABS/ - reinforced suspension <sup>7)</sup>			
	1.5 dCi	42	12.02	12.07 - ABS			
	1.5 dCi (FC07)	48	12.01	12.07 - ABS			
	1.9 D	47	03.98	12.07 - ABS			
	1.9 D (FC0D)	40	03.98	12.07 - ABS			
1.9 dTi (FC0U)	59	02.00	12.07 - ABS				
↓	1.0	40	07.03	12.07	G2121106		259 20,6 17,7 V +S +C

<sup>1)</sup> + passo lungo / + empattement court / + distancia corta entre ejes / + kurzer Radstand

<sup>2)</sup> + passo lungo / + empattement long / + distancia larga entre ejes / + langer Radstand

<sup>3)</sup> + ruota 14" / + roue 14" / + rueda 14" / + 14" Rad

<sup>4)</sup> + ruota 15"/16" / + roue 15"/16" / + rueda 15"/16" / + 15"/16" Rad

<sup>5)</sup> + dischi freno 258mm / + disques de frein 258mm / + disco de freno 258mm / + Bremsscheibe 258mm

<sup>6)</sup> + dischi freno 280mm / + disques de frein 280mm / + disco de freno 280mm / + Bremsscheibe 280mm

<sup>7)</sup> - ABS/ - sospensione rinforzata / - ABS/ - chssis renforc / - ABS/ - suspensin reforzada / - ABS/ - verstrktes Fahrwerk



**RENAULT KANGOO Express/Rapid (FC\_) (98-07)**

	1.2	43		03.98	12.07	+ ABS	G2121106		259 20,6 17,7 V +S +C				
	1.2	44		07.98	07.01								
	1.2 16V	55		10.01	12.07								
	1.4	55		03.98	12.07	+ ABS/ + reinforced suspens. 1)							
	1.5 dCi	42		12.02	12.07	+ ABS							
	1.5 dCi	50		06.05	12.07								
	1.5 dCi	62		06.05	12.07								
	1.5 dCi (FC07)	48		12.01	12.07								
	1.5 dCi (FC08/09)	60		04.03	12.07								
	1.6 16V	70		10.01	12.07								
1.9 D	47		03.98	12.07	+ ABS	G2124158		280 24,0 21,8 V L +S +C					
1.9 D	48		09.99	06.03	+ ABS								
1.9 D (FC0D)	40		03.98	12.07	+ ABS								
1.9 dCi 4x4 (FC0V)	59		10.01	12.07									
1.9 dTi (FC0U)	59		02.00	12.07	+ ABS								
1.6 16V 4x4	70		10.01	12.07									
1.9 dCi 4x4 (FC0V)	59		10.01	12.07									
1.6 16V 4x4	70		10.01	12.07						G1020563		23557 17,2 /S	BOS
1.9 dCi 4x4 (FC0V)	59		10.01	12.07									

**RENAULT KANGOO Express/Rapid (FW\_) (08-)**

	1.2 TCe 115	84		05.13		+ 15"/16" wheel 2)	G1020875 G1020876		24693 18,5 /Acc/S 24693 17,5 /Acc/S	LUC LUC
	1.5 dCi	50		02.08		+ 15"/16" wheel 2)				
	1.5 dCi	76		02.08		+ 15"/16" wheel 2)				
	1.5 dCi 110	80		09.10		+ 15"/16" wheel 2)				
	1.5 dCi 75	55		09.10		+ 15"/16" wheel 2)				
	1.5 dCi 85	63		02.08		+ 15"/16" wheel 2)				
	1.5 dCi 90	66		06.09		+ 15"/16" wheel 2)				
	1.6	64		02.08		+ 15"/16" wheel 2)				
	1.6 16V	78		02.08		+ 15"/16" wheel 2)				
	1.6 16V LPG	72		02.08		+ 15"/16" wheel 2)				
	1.2 TCe 115	84		05.13		+ 14" wheel 3)	G1020741	+ ventilated discs 4)	23973 17,1 /Acc/S	LUC
	1.5 dCi	50		02.08		+ 14" wheel 3)				
	1.5 dCi	76		02.08		+ 14" wheel 3)				
	1.5 dCi 110	80		09.10		+ 14" wheel 3)				
	1.5 dCi 75	55		09.10		+ 14" wheel 3)				
	1.5 dCi 85	63		02.08		+ 14" wheel 3)				
	1.5 dCi 90	66		06.09		+ 14" wheel 3)				
	1.6	64		02.08		+ 14" wheel 3)				
	1.6 16V	78		02.08		+ 14" wheel 3)				
	1.6 16V LPG	72		02.08		+ 14" wheel 3)				
Z.E.	44		10.11		+ 14" wheel 3)					
	1.2 TCe 115	84		05.13		+ 14" wheel 3)	G2122270		258 22,0 19,8 V L +S +C	
	1.5 dCi	50		02.08		+ 14" wheel 3)				
	1.5 dCi	76		02.08		+ 14" wheel 3)				
	1.5 dCi 110	80		09.10		+ 14" wheel 3)				
	1.5 dCi 75	55		09.10		+ 14" wheel 3)				
	1.5 dCi 85	63		02.08		+ 14" wheel 3)				
	1.5 dCi 90	66		06.09		+ 14" wheel 3)				
	1.6	64		02.08		+ 14" wheel 3)				
	1.6 16V	78		02.08		+ 14" wheel 3)				
	1.6 16V LPG	72		02.08		+ 14" wheel 3)				
Z.E.	44		10.11		+ 14" wheel 3)					
	1.2 TCe 115	84		05.13		+ 15"/16" wheel 2)	G2124222		280 24,0 21,8 V L +S +C	
	1.5 dCi	50		02.08		+ 15"/16" wheel 2)				
	1.5 dCi	76		02.08		+ 15"/16" wheel 2)				
	1.5 dCi 110	80		09.10		+ 15"/16" wheel 2)				
	1.5 dCi 75	55		09.10		+ 15"/16" wheel 2)				
	1.5 dCi 85	63		02.08		+ 15"/16" wheel 2)				
	1.5 dCi 90	66		06.09		+ 15"/16" wheel 2)				
	1.6	64		02.08		+ 15"/16" wheel 2)				
	1.6 16V	78		02.08		+ 15"/16" wheel 2)				
	1.6 16V LPG	72		02.08		+ 15"/16" wheel 2)				
	1.2 TCe 115	84		05.13		+ 15"/16" wheel 2)	G1020874		24692 15,9 /Acc/S	LUC
	1.5 dCi	50		02.08		+ 15"/16" wheel 2)				
	1.5 dCi	76		02.08		+ 15"/16" wheel 2)				
	1.5 dCi 110	80		09.10		+ 15"/16" wheel 2)				
	1.5 dCi 75	55		09.10		+ 15"/16" wheel 2)				
	1.5 dCi 85	63		02.08		+ 15"/16" wheel 2)				
	1.5 dCi 90	66		06.09		+ 15"/16" wheel 2)				
	1.6	64		02.08		+ 15"/16" wheel 2)				
	1.6 16V	78		02.08		+ 15"/16" wheel 2)				
	1.6 16V LPG	72		02.08		+ 15"/16" wheel 2)				
Z.E.	44		10.11		+ 15"/16" wheel 2)					

**RENAULT KOLEOS (HYO\_) (08-)**

	2.0 dCi	110		09.08			G1201029		23698 16,8 +/Wl	SUM
	2.0 dCi	130		09.08						
	2.0 dCi 4x4	110		09.08						
	2.0 dCi 4x4	127		09.08						
	2.5 16V	126		09.08						
	2.5 16V 4x4	126		09.08						

1) + ABS/ + sospensione rinforzata / + ABS/ + châssis renforcé / + ABS/ + suspensión reforzada / + ABS/ + verstärktes Fahrwerk

2) + ruota 15"/16" / + roue 15"/16" / + rueda 15"/16" / + 15"/16" Rad

3) + ruota 14" / + roue 14" / + rueda 14" / + 14" Rad

4) + dischi ventilati / + disques ventilés / + disco ventilado / + belüftete Scheiben





### RENAULT LAGUNA I Saloon (B56\_/556\_) (93-00)

	1.6 16V	79	11.97	03.99	G1020326		21388 18,0 +/W/S	LUC
	1.8	69	04.95	02.01				
	1.8 (B56A/B)	66	11.93	02.01 + ABS				
	1.8 (B56S/T/0)	66	08.95	02.01				
	1.8 16V (B563,B564)	88	04.98	03.99				
	1.9 dTi	72	10.97	03.99				
	2.0 (B56C/H/N)	83	11.93	02.01				
	2.0 (L)	70	06.95	03.99				
	2.0 16V (B56D/M)	102	05.95	02.01				
	2.2 D (B56F/2)	61	11.93	02.01 + ABS				
2.2 dT	83	03.96	08.99					
3.0 V6	140	03.97	08.99					
3.0 V6 (B56E/R,B565)	123	11.93	02.01					
	1.6 16V	79	04.99	02.01	G1020569		23172 18,0 /WD/Acc/S	LUC
	1.8 16V (B563,B564)	88	04.99	02.01				
	1.9 dCi	79	09.99	02.01				
	1.9 dTi	72	04.99	02.01				
	2.0 (L)	70	04.99	02.01				
	2.0 (U)	80	04.99	02.01				
	2.0 16V (556A/B)	103	09.99	02.01				
	2.2 dT	83	09.99	02.01				
	3.0 V6	140	09.99	02.01				
		1.6 16V	79	11.97				
1.8 (B56S/T/0)		66	05.98	02.01				
1.8 16V (B563,B564)		88	09.99	02.01				
1.9 dCi		79	09.99	02.01				
1.9 dTi		72	10.97	02.01				
2.0 (L)		70	05.98	02.01				
2.0 (U)		80	03.99	02.01				
2.0 16V (556A/B)		103	09.99	02.01				
2.0 16V (B56D/M)		102	05.95	02.01				
2.2 dT		83	09.99	02.01				
3.0 V6	140	09.99	02.01					
	1.8	69	04.95	02.01	G2122148	for 4 bore wheel rim <sup>1)</sup>	262 22,0 19,8 V L +S +C	
	1.8 (B56A/B)	66	11.93	02.01				
	1.8 (B56S/T/0)	66	08.95	04.98				
	2.0 (B56C/H/N)	83	11.93	02.01 - Baccara				
	2.0 (L)	70	06.95	04.98 - Baccara				
	2.0 (L)	70	06.95	02.01 + RNVAIze/Business				
	2.2 D (B56F/2)	61	11.93	02.01				
	1.8 16V (B563,B564)	88	04.98	08.99 + Initiale				
	1.9 dTi	72	10.97	02.01				
	2.0 (L)	70	05.98	08.99 + Initiale				
2.0 (U)	80	03.99	02.01					
2.0 16V	103	05.95	02.01					
2.0 16V (B56D/M)	102	05.95	02.01					
2.2 dT	83	03.96	08.99					
3.0 V6	140	03.97	08.99					
3.0 V6 (B56E/R,B565)	123	11.93	02.01					
	1.8	69	04.95	06.95 + ABS	G1020327		20410 15,0 +	BRE
	1.8 (B56A/B)	66	11.93	02.01 + ABS				
	1.8 (B56S/T/0)	66	08.95	02.01 + ABS				
	2.0 (B56C/H/N)	83	11.93	02.01 + Baccara				
	2.0 (B56C/H/N)	83	11.93	06.95 + ABS/ - Baccara				
	2.0 (L)	70	06.95	01.97 + Initiale				
	2.0 (L)	70	06.95	02.01 + Baccara				
	2.0 16V (B56D/M)	102	05.95	01.97 + ABS				
	2.0 16V (B56D/M)	102	05.95	12.97 - ABS				
	2.2 D (B56F/2)	61	11.93	06.95 + ABS				
2.2 dT	83	03.96	01.97 + ABS					
2.2 dT	83	03.96	12.97 - ABS					
3.0 V6 (B56E/R,B565)	123	11.93	01.97					

### RENAULT LAGUNA I Grandtour (K56\_) (95-00)

	1.6 16V (8)	79	11.97	02.01	G1020326		21388 18,0 +/W/S	LUC
	1.8 (0)	66	06.95	02.01				
	1.8 (S)	66	06.95	02.01				
	1.8 (T)	66	07.95	02.01				
	1.8 (Z)	69	07.95	02.01				
	1.8 16V (3)	88	02.99	02.01				
	1.8 16V (4)	88	04.98	02.01				
	1.9 dTi	72	10.97	02.01				
	2.0	84	10.98	02.01				
	2.0 (C)	83	06.95	02.01				
	2.0 (H)	83	06.95	02.01				
	2.0 (L)	70	11.95	02.01				
	2.0 (N)	83	09.95	02.01				
	2.0 16V (D)	102	09.95	02.01				
	2.0 16V (M)	102	09.95	02.01				
	2.2 D	61	06.95	02.01				
	2.2 dT	83	03.96	02.01				
	3.0 V6	123	02.96	02.01				
	3.0 V6	140	03.97	02.01				
		1.6 16V (1)	79	02.99				
1.8 16V (Y)		88	05.99	02.01				
1.9 dCi		79	09.99	02.01				
2.0 16V (A)		102	09.99	02.01				

<sup>1)</sup> per cerchione a 4 fori / pour jante à 4 trous / para Llantas de 4 taladros / für 4-Loch-Felge

<sup>2)</sup> per cerchione a 5 fori / pour jante à 5 trous / para Llantas de 5 taladros / für 5-Loch-Felge



RENAULT LAGUNA I Grandtour (K56_) (95-00)														
	2.0 16V (B)	102		09.99	02.01		G1020569		23172 18,0 /WD/Acc/S	LUC				
	1.8 (O)	66		06.95	04.98		G2122148	for 4 bore wheel rim <sup>1)</sup>	262 22,0 19,8 V L +S +C					
	1.8 (S)	66		06.95	02.01									
	1.8 (T)	66		07.95	02.01									
	1.8 (Z)	69		07.95	02.01									
	2.0	84		10.98	02.01									
	2.0 (C)	83		06.95	02.01									
	2.0 (H)	83		06.95	02.01									
	2.0 (L)	70		11.95	04.98									
	2.0 (N)	83		09.95	02.01									
	2.2 D			06.95	02.01									
	1.6 16V	79		11.97	02.01		G2124158	for 4 bore wheel rim <sup>1)</sup>	280 24,0 21,8 V L +S +C					
	1.8 (O)	66		05.98	02.01									
	1.8 16V (3)	88		02.99	02.01									
	1.8 16V (4)	88		04.98	02.01	- Fairway								
	1.8 16V (Y)	88		05.99	02.01									
	1.9 dCi	79		09.99	02.01									
	1.9 dTi	72		10.97	02.01									
	2.0 (L)	70		05.98	02.01									
	2.0 16V (A)	102		09.99	02.01									
	2.0 16V (B)	102		09.99	02.01									
	2.2 dT			03.96	02.01									
	3.0 V6	140		09.99	02.01									
	3.0 V6	140		09.99	02.01									
	1.8 16V (4)	88		04.98	02.01	+ Fairway	G2124171	for 5 bore wheel rim <sup>2)</sup>	280 24,0 21,8 V L +S +C					
	2.0 16V (D)	102		09.95	02.01									
	2.0 16V (M)	102		09.95	02.01									
	2.2 dT			03.96	02.01									
	3.0 V6	123		02.96	02.01									
	3.0 V6	140		03.97	08.99		G2124171	for 5 bore wheel rim <sup>2)</sup>	280 24,0 21,8 V L +S +C					
	1.8 (O)	66		06.95	05.96	+ ABS	G1020327		20410 15,0 +	BRE				
	1.8 (S)	66		06.95	05.96	+ ABS								
	1.8 (T)	66		07.95	05.96	+ ABS								
	1.8 (Z)	69		07.95	05.96	+ ABS								
	2.0	84		10.98	02.01	+ ABS								
	2.0 (C)	83		06.95	05.96	+ ABS								
	2.0 (H)	83		06.95	05.96	+ ABS								
	2.0 (L)	70		11.95	05.96	+ ABS								
	2.0 16V (D)	102		09.95	02.01									
	2.0 16V (M)	102		09.95	01.97									
	2.2 D			06.95	05.96	+ ABS								
	2.2 dT			03.96	01.97									
	3.0 V6 (5)	123		03.96	02.01									
	3.0 V6 (R)	123		02.96	02.01									
RENAULT LAGUNA II Saloon (BG_) (01-07)														
	1.6 16V	79		03.01	06.07		G1020576 G1020547	+ 16" wheel, + steel rims <sup>3)</sup> + 16"/17" wheel, + light all.rim	23215 18,3 +/WD 23245 18,3 +	ATE ATE				
	1.6 16V	82		02.05	06.07									
	1.8 16V (O4/O6/OV)	89		03.01	06.07		G1020547		23245 18,3 +	ATE				
	1.8 16V (OB/OC/OM)	88		03.01	06.07									
	1.8 16V (OJ)	85		03.01	06.07									
	1.9 dCi	79		03.01	06.07									
	1.9 dCi	81		01.05	06.07									
	1.9 dCi	96		05.05	06.07									
	1.9 dCi (O8/O10)	68		03.04	06.07									
	1.9 dCi (OE)	77		06.01	06.07									
	1.9 dCi (OG)	88		03.01	06.07									
	1.9 dCi (OR)	74		10.01	06.07									
	2.0 16V (OO/OK/OW)	99		08.02	06.07									
	2.0 16V IDE (ON/OP)	103		04.01	06.07									
	2.2 dCi	102		05.05	06.07									
	2.2 dCi	110		05.05	06.07									
	2.2 dCi	110		10.01	11.01									
	2.0 16V	125		01.05	06.07						G1020548		23248 18,3 +	ATE
	2.0 16V Sport	150		01.05	06.07									
	2.0 16V Turbo	120		01.03	06.07									
	2.0 dCi	110		08.05	06.07									
	2.0 dCi 130	127		01.06	06.07									
	2.2 dCi	110		12.01	04.05									
	3.0 V6	152		03.01	06.07									
	1.6 16V	79		03.01	06.07		G2124169	+ 16" wheel, + steel rims <sup>3)</sup>	280 24,0 21,8 V L +C					
	1.6 16V	82		02.05	06.07									
	1.8 16V (O4/O6/OV)	89		03.01	06.07									
	1.8 16V (OB/OC/OM)	88		03.01	06.07									
	1.8 16V (OJ)	85		03.01	06.07									
	1.9 dCi	79		03.01	06.07									
	1.9 dCi	81		01.05	06.07									
	1.9 dCi	96		05.05	06.07									
	1.9 dCi (O8/O10)	68		03.04	06.07									
	1.9 dCi (OE)	77		06.01	06.07									
	1.9 dCi (OG)	88		03.01	06.07									
	1.9 dCi (OR)	74		10.01	06.07									
	2.0 16V (OO/OK/OW)	99		08.02	06.07									
	2.0 16V IDE (ON/OP)	103		04.01	06.07									

1) per cerchione a 4 fori / pour jante à 4 trous / para Llantas de 4 taladros / für 4-Loch-Felge  
2) per cerchione a 5 fori / pour jante à 5 trous / para Llantas de 5 taladros / für 5-Loch-Felge  
3) + ruota 16", +cerchione i.acc. / + roue 16", + jante en acier / + rueda 16", +Llanta da acero / + 16" Rad/ + Stahlfelgen







**RENAULT LAGUNA II Saloon (BG\_) (01-07)**









	1.6 16V	79		03.01	06.07	G1020470		23482 15,8 +/WD	ATE
	1.6 16V	82		02.05	06.07				
	1.8 16V (04/06/0V)	89		03.01	06.07				
	1.8 16V (0B/0C/0M)	88		03.01	06.07				
	1.8 16V (0J)	85		03.01	06.07				
	1.9 dCi	79		03.01	06.07				
	1.9 dCi	81		01.05	06.07				
	1.9 dCi	96		05.05	06.07				
	1.9 dCi (08/10)	68		03.04	06.07				
	1.9 dCi (0E)	77		06.01	06.07				
	1.9 dCi (0G)	88		03.01	06.07				
	1.9 dCi (0R)	74		10.01	06.07				
	2.0 16V	125		01.05	06.07				
	2.0 16V (00/0K/0W)	99		08.02	06.07				
	2.0 16V IDE (0N/0P)	103		04.01	06.07				
	2.0 16V Sport	150		01.05	06.07				
	2.0 16V Turbo	120		01.03	06.07				
	2.0 dCi	110		08.05	06.07				
	2.0 dCi 130	127		01.06	06.07				
	2.2 dCi	102		05.05	06.07				
	2.2 dCi	110		10.01	06.07				
	3.0 V6	152		03.01	06.07				

**RENAULT LAGUNA II Grandtour (KG\_) (01-07)**

	1.6 16V	79		03.01	06.07	G1020576 G1020547	+ 16" wheel, + steel rims <sup>1)</sup> + 16"/17" wheel, + light all.rim	23215 18,3 +/WD	ATE
	1.6 FlexFuel	76		06.01	10.03				
	1.8 16V (04/06/0V)	89		03.01	06.07				
	1.8 16V (0B/0C/0M)	88		03.01	06.07				
	1.8 16V (0J)	85		03.01	06.07				
	1.9 dCi	79		03.01	06.07				
	1.9 dCi	81		01.05	06.07				
	1.9 dCi	96		05.05	06.07				
	1.9 dCi (08/10)	68		03.04	06.07				
	1.9 dCi (0E)	77		06.01	06.07				
	1.9 dCi (0G)	88		03.01	06.07				
	1.9 dCi (0R)	74		10.01	06.07				
	2.0 16V (00/0K/0W)	99		08.02	06.07				
	2.0 16V IDE (0N/0P)	103		04.01	06.07				
		2.2 dCi	102		05.05			06.07	G1020547
	2.2 dCi	110		05.05	06.07				
	2.2 dCi	110		10.01	11.01				
	2.0 16V	125		01.05	06.07	G1020548		23248 18,3 +	ATE
	2.0 16V Sport	150		01.05	06.07				
	2.0 16V Turbo	120		01.03	06.07				
	2.0 dCi	110		08.05	06.07				
	2.0 dCi 130	127		01.06	06.07				
	2.2 dCi	110		12.01	04.05				
	3.0 V6	152		03.01	06.07				
	1.6 16V	79		03.01	06.07	G2124169	+ 16" wheel, + steel rims <sup>1)</sup>	280 24,0 21,8 V L +C	
	1.6 FlexFuel	76		06.01	10.03				
	1.8 16V (04/06/0V)	89		03.01	06.07				
	1.8 16V (0B/0C/0M)	88		03.01	06.07				
	1.8 16V (0J)	85		03.01	06.07				
	1.9 dCi	79		03.01	06.07				
	1.9 dCi	81		01.05	06.07				
	1.9 dCi	96		05.05	06.07				
	1.9 dCi (08/10)	68		03.04	06.07				
	1.9 dCi (0E)	77		06.01	06.07				
	1.9 dCi (0G)	88		03.01	06.07				
	1.9 dCi (0R)	74		10.01	06.07				
	2.0 16V (00/0K/0W)	99		08.02	06.07				
	2.0 16V IDE (0N/0P)	103		04.01	06.07				
		1.6 16V	79		03.01				
1.6 FlexFuel		76		06.01	10.03				
1.8 16V (04/06/0V)		89		03.01	06.07				
1.8 16V (0B/0C/0M)		88		03.01	06.07				
1.8 16V (0J)		85		03.01	06.07				
1.9 dCi		79		03.01	06.07				
1.9 dCi		81		01.05	06.07				
1.9 dCi		96		05.05	06.07				
1.9 dCi (08/10)		68		03.04	06.07				
1.9 dCi (0E)		77		06.01	06.07				
1.9 dCi (0G)		88		03.01	06.07				
1.9 dCi (0R)		74		10.01	06.07				
2.0 16V		125		01.05	06.07				
2.0 16V (00/0K/0W)		99		08.02	06.07				
2.0 16V IDE (0N/0P)		103		04.01	06.07				
2.0 16V Sport		150		01.05	06.07				
2.0 16V Turbo		120		01.03	06.07				
2.0 dCi		110		08.05	06.07				
2.0 dCi 130		127		01.06	06.07				
2.2 dCi		102		05.05	06.07				
2.2 dCi	110		10.01	06.07					
3.0 V6	152		03.01	06.07					

























<sup>1)</sup> + ruota 16", + cerchione i.acc. / + roue 16", + jante en acier / + rueda 16", + Llanta da acero / + 16" Rad/ + Stahlfelgen



									
<b>RENAULT LAGUNA III Saloon (BT0/1) (07-)</b>									
	2.0 16V 2.0 16V Hi-Flex 2.0 16V Turbo 2.0 dCi 2.0 dCi 2.0 dCi 2.0 dCi GT	103 103 125 96 110 127 131		09.07 09.07 09.07 09.07 01.08 03.08				G1020834	24709 18,6 + ATE
				- 4 wheel steering <sup>1)</sup> - 4 wheel steering <sup>1)</sup> - 4 wheel steering <sup>1)</sup> - 4 wheel steering <sup>1)</sup>					
	1.5 dCi 1.6 16V	81 81		09.07 09.07				G2124221	280 24,0 21,8 V L +S +C
<b>RENAULT LAGUNA III Coupe (DT0/1) (07-)</b>									
	2.0 16V Turbo 2.0 dCi 2.0 dCi 2.0 dCi GT	125 110 127 131		09.08 10.07 09.08 03.08				G1020834	24709 18,6 + ATE
				- 4 wheel steering <sup>1)</sup> - 4 wheel steering <sup>1)</sup> - 4 wheel steering <sup>1)</sup>					
	1.5 dCi	81		03.12				G2124221	280 24,0 21,8 V L +S +C
<b>RENAULT LAGUNA III Grandtour (KT0/1) (07-)</b>									
	2.0 16V 2.0 16V Hi-Flex 2.0 16V Turbo 2.0 dCi 2.0 dCi 2.0 dCi 2.0 dCi GT	103 103 125 96 110 127 131		09.07 09.07 09.07 09.07 09.07 03.08				G1020834	24709 18,6 + ATE
				- 4 wheel steering <sup>1)</sup> - 4 wheel steering <sup>1)</sup> - 4 wheel steering <sup>1)</sup> - 4 wheel steering <sup>1)</sup>					
	1.5 dCi 1.6 16V	81 81		09.07 09.07				G2124221	280 24,0 21,8 V L +S +C
<b>RENAULT LATITUDE (L70_) (11-13)</b>									
	1.5 dCi 2.0 16V 2.0 16V eco2 2.0 dCi 150 2.5 dCi	81 103 103 110		02.11 06.13 02.11 06.13 02.11 06.13 02.11 06.13 05.11 06.13				G1020834	24709 18,6 + ATE
<b>RENAULT LOGAN (LS_) (04-13)</b>									
	1.4 1.5 dCi 1.5 dCi 1.6 1.6	55 50 63 64 77		09.04 04.13 04.07 04.13 02.08 04.13 09.04 04.13 04.07 04.13				G1020501	21463 18,2 /M/S LUC
	1.4 1.6 1.5 dCi 1.5 dCi 1.6	55 64 50 63 77		09.04 04.13 09.04 04.13 04.07 04.13 02.08 04.13 04.07 04.13				G2112116 G2112171 G2121106	- ABS + ABS 238 12,0 10,5 +S +C 259 12,0 10,6 +S +C 259 20,6 17,7 V +S +C
<b>RENAULT LOGAN Estate (KS_) (04-13)</b>									
	1.4 1.5 dCi 1.5 dCi 1.6 1.6	55 50 63 64 77		10.07 04.13 04.07 04.13 02.08 04.13 04.07 04.13 04.07 04.13				G1020501	21463 18,2 /M/S LUC
	1.4 1.6 1.5 dCi 1.5 dCi 1.6	55 64 50 63 77		10.07 04.13 04.07 04.13 04.07 04.13 02.08 04.13 04.07 04.13				G2112116 G2112171 G2121106	- ABS + ABS 238 12,0 10,5 +S +C 259 12,0 10,6 +S +C 259 20,6 17,7 V +S +C
<b>RENAULT LOGAN Express (07-)</b>									
	1.5 dCi 1.6	50 64		04.07 04.13 04.07 04.13				G1020741	23973 17,1 /Acc/S LUC
	1.5 dCi 1.6	50 64		04.07 04.13 04.07 04.13				G2122216	260 22,0 19,8 V L +S +C
<b>RENAULT MASCOTT (99-04)</b>									
	110.35 110.50 110.55 110.60 130.35 130.55 130.65 140.35 140.55 140.65 150.35 150.55 150.65	78 78 78 78 92 92 92 103 103 103 107 107 107		01.99 06.04 01.99 06.04 01.99 06.04 01.99 06.04 01.99 06.04 01.99 06.04 01.99 06.04 01.99 06.04 01.99 06.04 01.01 06.04 01.99 06.04 01.99 06.04 01.01 06.04				G1020357	29121 20,3 /WD/S BRE

<sup>1)</sup> - 4 route stertzanti / - 4 roues directionnelles / + dirección sobre cuatro ruedas / - 4-Rad Lenkung

<b>RENAULT MASCOTT (99-04)</b>									
	90.35	63		01.99	06.01		G1020357	29121 20,3 /WD/S	BRE
<b>RENAULT MASCOTT (04-10)</b>									
	120.35	85		05.04	12.10		G1020357	29121 20,3 /WD/S	BRE
	120.55	85		05.04	12.10				
	160.35	115		05.04	12.10				
	160.55	115		05.04	12.10				
	120.35	85		05.04	12.10		G1020357	29121 20,3 /WD/S	BRE
	120.55	85		05.04	12.10				
	160.35	115		05.04	12.10				
	160.55	115		05.04	12.10				
	120.65	85		05.04	12.10		G1020357	29121 20,3 /WD/S	BRE
	160.65	115		05.04	12.10				
<b>RENAULT MASTER II Bus (JD/ND) (98-06)</b>									
	1.9 dCi 80	60		11.01	08.06		G1020624	23613 17,7	BOS
	1.9 dTi	59		11.01	08.06				
	2.2 dCi 90	66		11.01	08.06				
	2.5 dCi 100	73		10.03	08.06				
	2.5 dCi 120	84		10.01	08.06				
	2.8 dTi	84		08.00	10.01				
	1.9 dCi 80	60		11.01	08.06		G1020627	23669 16,8 /S	BOS
	1.9 dTi	59		09.00	08.06				
	2.2 dCi 90	66		09.00	08.06				
	2.5 D	59		07.98	01.01				
	2.5 dCi 100	73		10.03	08.06				
	2.5 dCi 120	84		10.01	08.06				
	2.8 dTi	84		07.98	10.01				
	1.9 dCi 80	60		11.01	08.06		G2112155	305 12,0 10,5 +S +C	
	1.9 dTi	59		09.00	08.06				
	2.2 dCi 90	66		09.00	08.06				
	2.5 D	59		07.98	01.01				
	2.5 dCi 100	73		10.03	08.06				
	2.5 dCi 120	84		10.01	08.06				
	2.8 dTi	84		07.98	10.01				
<b>RENAULT MASTER II Van (FD_) (98-06)</b>									
	1.9 dCi 80	60		11.01	08.06		G1020624	23613 17,7	BOS
	1.9 dTi	59		11.01	08.06				
	2.2 dCi 90	65		11.01	08.06				
	2.5 dCi 100	73		10.03	08.06				
	2.5 dCi 120	84		10.01	08.06				
	2.8 dTi	84		08.00	10.01				
	3.0 dCi 120	85		06.05	08.06				
	3.0 dCi 140	100		10.03	08.06				
	3.0 dCi 160	115		06.05	08.06				
	1.9 dCi 80	60		11.01	08.06		G1020627	23669 16,8 /S	BOS
	1.9 dTi	59		09.00	08.06				
	2.2 dCi 90	65		09.00	08.06				
	2.5 D	59		08.00	01.01				
	2.5 dCi 100	73		10.03	08.06				
	2.5 dCi 120	84		10.01	08.06				
	2.8 dTi	84		08.00	10.01				
	3.0 dCi 120	85		06.05	08.06				
	3.0 dCi 140	100		10.03	08.06				
	3.0 dCi 160	115		06.05	08.06				
	1.9 dCi 80	60		11.01	08.06		G2112155	305 12,0 10,5 +S +C	
	1.9 dTi	59		09.00	08.06				
	2.2 dCi 90	65		09.00	08.06				
	2.5 D	59		08.00	01.01				
	2.5 dCi 100	73		10.03	08.06				
	2.5 dCi 120	84		10.01	08.06				
	2.8 dTi	84		08.00	10.01				
	3.0 dCi 120	85		06.05	08.06				
	3.0 dCi 140	100		10.03	08.06				
	3.0 dCi 160	115		06.05	08.06				
<b>RENAULT MASTER II Pickup/Chassis (ED/HD/UD) (98-06)</b>									
	2.2 dCi 90	66		11.01	08.06		G1020624	23613 17,7	BOS
	2.5 dCi 100	73		10.03	08.06				
	2.5 dCi 120	84		10.01	08.06				
	3.0 dCi 120	85		06.05	08.06				
	3.0 dCi 140	100		10.03	08.06				
	3.0 dCi 160	115		06.05	08.06				
	2.2 dCi 90	66		09.00	08.06		G1020627	23669 16,8 /S	BOS
	2.5 D	59		08.00	01.01				
	2.5 dCi 100	73		10.03	08.06				
	2.5 dCi 120	84		10.01	08.06				
	2.8 dTi	84		08.00	10.01				
	3.0 dCi 120	85		06.05	08.06				
	3.0 dCi 140	100		10.03	08.06				
	3.0 dCi 160	115		06.05	08.06				

								
<b>RENAULT MASTER II Pickup/Chassis (ED/HD/UD) (98-06)</b>								
	2.2 dCi 90	66		09.00	08.06		G2112155	305 12,0 10,5 +S +C
	2.5 D	59		08.00	01.01			
	2.5 dCi 100	73		10.03	08.06			
	2.5 dCi 120	84		10.01	08.06			
	2.8 dTi	84		08.00	10.01			
	3.0 dCi 120	85		06.05	08.06			
	3.0 dCi 140	100		10.03	08.06			
	3.0 dCi 160	115		06.05	08.06			
<b>RENAULT MASTER III Bus (JD_) (06-10)</b>								
	2.5 dCi	74		08.06	12.10		G1020624	23613 17,7 BOS
	2.5 dCi	88		08.06	12.10			
	2.5 dCi	107		08.06	12.10			
	2.5 dCi	74		08.06	12.10		G1020627	23669 16,8 /S BOS
	2.5 dCi	88		08.06	12.10			
	2.5 dCi	107		08.06	12.10			
	2.5 dCi	74		08.06	12.10		G2112155	305 12,0 10,5 +S +C
	2.5 dCi	88		08.06	12.10			
	2.5 dCi	107		08.06	12.10			
<b>RENAULT MASTER III Van (FD_) (06-10)</b>								
	2.5 dCi	74		08.06	12.10		G1020624	23613 17,7 BOS
	2.5 dCi	88		08.06	12.10			
	2.5 dCi	107		08.06	12.10			
	2.5 dCi	74		08.06	12.10		G1020627	23669 16,8 /S BOS
	2.5 dCi	88		08.06	12.10			
	2.5 dCi	107		08.06	12.10			
	2.5 dCi	74		08.06	12.10		G2112155	305 12,0 10,5 +S +C
	2.5 dCi	88		08.06	12.10			
	2.5 dCi	107		08.06	12.10			
<b>RENAULT MASTER III Pickup/Chassis (ED/HD/UD_) (06-10)</b>								
	2.5 dCi	74		08.06	12.10		G1020624	23613 17,7 BOS
	2.5 dCi	88		08.06	12.10			
	2.5 dCi	107		08.06	12.10			
	2.5 dCi	74		08.06	12.10		G1020627	23669 16,8 /S BOS
	2.5 dCi	88		08.06	12.10			
	2.5 dCi	107		08.06	12.10			
	2.5 dCi	74		08.06	12.10		G2112155	305 12,0 10,5 +S +C
	2.5 dCi	88		08.06	12.10			
	2.5 dCi	107		08.06	12.10			
<b>RENAULT MASTER IV Van / Estate / Bus (FV/JV) (10-)</b>								
	2.3 dCi FWD	74		02.10			G1020905	25147 18,4 +/Wl BRE
	2.3 dCi FWD	92		02.10				
	2.3 dCi FWD	107		02.10				
	2.3 dCi FWD	110		01.13				
	2.3 dCi RWD	74		02.10				
	2.3 dCi RWD	92		02.10				
	2.3 dCi RWD	107		02.10				
	2.3 dCi RWD	110		01.13				
	2.3 dCi FWD	74		02.10		+ single tyre <sup>1)</sup>	G1020907	25112 18,4 +/Wl BRE
	2.3 dCi FWD	92		02.10		+ single tyre <sup>1)</sup>		
	2.3 dCi FWD	107		02.10		+ single tyre <sup>1)</sup>		
	2.3 dCi FWD	110		01.13		+ single tyre <sup>1)</sup>		
	2.3 dCi RWD	74		02.10		+ single tyre <sup>1)</sup>		
	2.3 dCi RWD	92		02.10		+ single tyre <sup>1)</sup>		
	2.3 dCi RWD	107		02.10		+ single tyre <sup>1)</sup>		
	2.3 dCi RWD	110		01.13		+ single tyre <sup>1)</sup>		
<b>RENAULT MASTER IV Pickup/Chassis (EV/UV) (10-)</b>								
	2.3 dCi FWD	74		02.10			G1020905	25147 18,4 +/Wl BRE
	2.3 dCi FWD	92		02.10				
	2.3 dCi FWD	107		02.10				
	2.3 dCi FWD	110		01.13				
	2.3 dCi RWD	74		02.10				
	2.3 dCi RWD	92		02.10				
	2.3 dCi RWD	107		02.10				
	2.3 dCi RWD	110		01.13				
	2.3 dCi FWD	74		02.10		+ single tyre <sup>1)</sup>	G1020907	25112 18,4 +/Wl BRE
	2.3 dCi FWD	92		02.10		+ single tyre <sup>1)</sup>		
	2.3 dCi FWD	107		02.10		+ single tyre <sup>1)</sup>		
	2.3 dCi FWD	110		01.13		+ single tyre <sup>1)</sup>		
	2.3 dCi RWD	74		02.10		+ single tyre <sup>1)</sup>		
	2.3 dCi RWD	92		02.10		+ single tyre <sup>1)</sup>		
	2.3 dCi RWD	107		02.10		+ single tyre <sup>1)</sup>		
	2.3 dCi RWD	110		01.13		+ single tyre <sup>1)</sup>		
<b>RENAULT MEGANE I Saloon 3/5-door (BA_/SA_) (96-02)</b>								
	1.4 16V (D)	70		03.99	12.02		G1020501	21463 18,2 /W/S LUC
	1.4 16V (W)	70		06.98	12.02			
	1.4 e	55		01.96	12.02			
	1.4 Eco (T)	52		01.96	03.99			
	1.6 16V (4)	79		04.98	12.02	+ reinforced suspension <sup>2)</sup>		
	1.6 e	66		01.96	03.99			
	1.6 i	55		01.96	03.99			

<sup>1)</sup> + ruota singola / + roue simple / + cubierta simple / + Einfachbereifung

<sup>2)</sup> + sospensione rinforzata / + châssis renforcé / + suspensión reforzada / + verstärktes Fahrwerk



### RENAULT MEGANE I Saloon 3/5-door (BA\_/SA\_) (96-02)

	1.9 D (9)	47	01.96	12.02	G1020501		21463 18,2 /W/S	LUC	
	1.9 D (A)	47	01.96	12.02					
	1.9 D (R)	47	06.98	12.02					
	1.9 D (U)	47	01.96	12.02					
	1.9 dT	66	01.96	12.02					
	1.9 dTi (8)	72	03.97	02.01					
	1.9 dTi (BAON/SAON)	72	03.97	03.99					
	1.9 TDI	69	09.96	12.02					
	2.0 i		01.96	12.02					
	1.6 16V (4)	79	04.98	02.99					
	2.0 16V	108	07.96	12.02					
	- reinforced suspension <sup>1)</sup>								
	1.6 16V (11)	79	03.99	12.02	G1020569		23172 18,0 /WD/Acc/S	LUC	
	1.6 16V (1J)	79	03.99	12.02					
	1.6 16V (4)	79	03.99	12.02					
	1.6 16V (B)	79	03.99	12.02					
	1.8 16V	85	01.01	12.02					
	1.9 dCi		09.98	12.02					
	1.9 dTi (1U)	59	02.01	12.02					
	1.9 dTi (BAON/SAON)	72	04.99	02.01					
	- reinforced suspension <sup>1)</sup>								
	1.4 e (E)	55	01.96	10.97					
	1.4 Eco (T)	52	01.96	10.97					
	1.6 i	55	01.96	10.97					
1.9 D (A/U)	47	01.96	10.97						
	1.4 e (E)	55	11.97	09.98	G2112116		238 12,0 10,5 +S +C		
	1.4 Eco (T)	52	11.97	03.99					
	1.6 e	66	01.96	09.98					
	1.6 i	55	11.97	09.98					
	1.9 D (A)	47	11.97	09.98					
	1.9 D (U)	47	11.97	12.02					
	- reinforced suspension <sup>1)</sup>								
	1.4 16V (D)	70	03.99	12.02					
	1.4 16V (W)	70	06.98	12.02					
	1.4 e (E)	55	10.98	12.02					
	1.4 e (V)	55	06.98	12.02					
	1.6 e	66	10.98	03.99					
1.6 i	55	10.98	03.99						
1.9 D (9)	47	01.96	12.02						
1.9 D (A)	47	10.98	12.02						
1.9 D (R)	47	06.98	12.02						
1.9 dT	66	01.96	12.02						
1.9 dTi (8)	72	03.97	02.01						
1.9 dTi (BAON/SAON)	72	03.97	02.99						
1.9 TDI	69	09.96	12.02						
2.0 i		01.96	12.02						
2.0 16V	108	07.96	09.98						
	1.6 16V (11)	79	03.99	12.02	G2121106		259 20,6 17,7 V +S +C		
	1.6 16V (1J)	79	03.99	12.02					
	1.6 16V (4)	79	04.98	12.02					
	1.6 16V (B)	79	03.99	12.02					
	1.8 16V	85	01.01	12.02					
	1.9 dCi		09.98	12.02					
	1.9 dTi (1U)	59	02.01	12.02					
	1.9 dTi (BAON/SAON)	72	03.99	02.01					
	2.0 16V	108	10.98	12.02					
	- reinforced suspension <sup>1)</sup>								
	1.4 16V (D)	70	03.99	12.02					
	1.4 16V (B)	79	03.99	12.02					
1.8 16V (12)	85	01.01	12.02						
1.8 16V (1A)	85	01.01	12.02						
1.8 16V (1M)	85	01.01	12.02						
1.8 16V (1R)	85	01.01	12.02						
1.9 dCi (F)	75	02.01	12.02						
2.0 16V	108	07.96	12.02						
	1.4 16V (D)	70	03.99	12.02	G1020216		20973 11,0 +	BDX	
	1.6 16V (B)	79	03.99	12.02					
	1.8 16V (12)	85	01.01	12.02					
	1.8 16V (1A)	85	01.01	12.02					
	1.8 16V (1M)	85	01.01	12.02					
	1.8 16V (1R)	85	01.01	12.02					
	1.9 dCi (F)	75	02.01	12.02					
	2.0 16V	108	07.96	12.02					
	+ ASR								
	+ ASR								
	+ ASR								
	+ ASR								
+ ASR									
+ ASR									
	1.4 16V (D)	70	03.99	12.02	G2108108	without sensor ring <sup>2)</sup>	238 8,0 7,0 +C		
	1.6 16V (B)	79	03.99	12.02					
	1.8 16V (12)	85	01.01	12.02					
	1.8 16V (1A)	85	01.01	12.02					
	1.8 16V (1M)	85	01.01	12.02					
	1.8 16V (1R)	85	01.01	12.02					
	1.9 dCi (F)	75	02.01	12.02					
	2.0 16V	108	07.96	12.02					
	+ ASR								
	+ ASR								
	+ ASR								
	+ ASR								
+ ASR									

### RENAULT MEGANE I Classic (LA\_) (96-02)



















	1.4 16V (0W)	70	06.98	12.02	G1020501		21463 18,2 /W/S	LUC	
	1.4 e (0E)	55	09.96	12.02					
	1.4 e (0V)	55	04.98	12.02					
	1.6 16V (1C)	79	09.99	12.02					
	1.6 16V (04)	79	04.98	12.02					
	1.6 e	66	09.96	03.99					
	1.6 i	55	09.96	03.99					
	1.9 D (0A)	47	09.96	12.02					
	1.9 D (0R)	47	09.98	12.02					
	1.9 D (0U)	47	09.96	12.02					
	1.9 dT	66	09.96	12.02					
	1.9 dTi (1U)	59	02.01	12.02					
	1.9 dTi (08)	72	03.97	02.01					
	1.9 dTi (0N)	72	03.97	02.99					
	1.9 TDI	69	09.96	12.02					
	+ reinforced suspension <sup>3)</sup>								

<sup>1)</sup> - sospensione rinforzata / - châssis renforcé / - suspensión reforzada / - verstärktes Fahrwerk

<sup>2)</sup> senza sensori / sans secours ABS / sin anillo sensor ABS / ohne Sensorring

<sup>3)</sup> + sospensione rinforzata / + châssis renforcé / + suspensión reforzada / + verstärktes Fahrwerk



									
<b>RENAULT MEGANE I Coach (DA_) (95-03)</b>									
	1.9 dCi	72		10.00	02.03	G2124158	280 24,0 21,8 V L +S +C		
	1.9 dTi	103		03.99	02.03				
	2.0 16V (O3)	103		07.98	02.03				
	2.0 16V (OH)	108		09.95	02.03				
	2.0 16V (OH)	108		09.98	02.03				
	2.0 16V (OP)	103		10.00	02.03				
	2.0 16V (OH)	108		09.95	08.98	G2122148	262 22,0 19,8 V L +S +C		
	1.4 16V (OD)	70		10.00	02.03	G1020216	20973 11,0 + BDX		
	1.6 16V (OB)	79		10.00	02.03				
	1.9 dCi (1F)	75		10.00	02.03				
	2.0 16V (O3)	103		07.98	02.03				
	2.0 16V (OH)	108		09.95	02.03				
2.0 16V (OP)	103		10.00	02.03					
	1.4 16V (OD)	70		10.00	02.03	G2108108	238 8,0 7,0 +C		
	1.6 16V (OB)	79		10.00	02.03				
	1.9 dCi (1F)	75		10.00	02.03				
	2.0 16V (O3)	103		07.98	02.03				
	2.0 16V (OH)	108		09.95	02.03				
	2.0 16V (OP)	103		10.00	02.03				
<b>RENAULT MEGANE I Convertible (EA_) (96-03)</b>									
	1.4 16V (W)	70		06.98	10.03	G1020501	21463 18,2 /W/S LUC		
	1.6 e	66		08.96	10.03				
	2.0 i			12.96	10.03				
	1.4 16V (D)	70		10.00	10.03			G1020569	23172 18,0 /WD/Acc/S LUC
	1.6 16V	79		09.98	10.03				
	2.0 16V	102		01.02	10.03				
	2.0 16V (3)	103		09.98	10.03				
2.0 16V (P)	103		10.00	10.03					
2.0 16V (H)	108		08.96	10.03					
	1.6 e	66		08.96	10.97	G2120125	238 20,1 17,7 V +S +C		
	1.4 16V (D)	70		10.00	10.03	G2121106	259 20,6 17,7 V +S +C		
	1.4 16V (W)	70		06.98	10.03				
	1.6 e	66		11.97	10.03				
	2.0 i			12.96	10.03				
	1.6 16V	79		09.98	10.03			G2124158	280 24,0 21,8 V L +S +C
2.0 16V	102		01.02	10.03					
2.0 16V (3)	103		09.98	10.03					
2.0 16V (H)	108		08.96	10.03					
2.0 16V (H)	108		09.98	10.03					
2.0 16V (P)	103		10.00	10.03					
	2.0 16V (H)	108		08.96	08.98	G2122148	262 22,0 19,8 V L +S +C		
	1.4 16V (D)	70		10.00	10.03	G1020216	20973 11,0 + BDX		
	1.6 16V (B)	79		10.00	10.03				
	2.0 16V	102		01.02	10.03				
	2.0 16V (3)	103		09.98	10.03				
	2.0 16V (H)	108		08.96	10.03				
2.0 16V (P)	103		10.00	10.03					
	1.4 16V (D)	70		10.00	10.03	G2108108	238 8,0 7,0 +C		
	1.6 16V (B)	79		10.00	10.03				
	2.0 16V	102		01.02	10.03				
	2.0 16V (3)	103		09.98	10.03				
	2.0 16V (H)	108		08.96	10.03				
	2.0 16V (P)	103		10.00	10.03				
<b>RENAULT MEGANE I Grandtour (KA_) (98-03)</b>									
	1.4 16V	70		09.98	12.03	G1020501	21463 18,2 /W/S LUC		
	1.4 e	55		09.98	12.03				
	1.6 e	66		09.98	12.03				
	1.9 D	47		03.99	12.03				
	1.9 dTi (ON)	72		01.99	12.03				
	1.6 16V	79		09.98	12.03	G1020326	21388 18,0 +/W/S LUC		
	1.8 16V	85		01.01	12.03				
	1.9 dCi	75		01.01	12.03				
	1.9 dTi (1U)	59		02.01	12.03				
	1.9 dTi (ON)	72		01.99	12.03				
	1.4 16V	70		09.98	12.03	G2121106	259 20,6 17,7 V +S +C		
	1.4 e	55		09.98	12.03				
	1.6 e	66		09.98	12.03				
	1.9 D	47		03.99	12.03				
	1.6 16V	79		09.98	12.03			G2124158	280 24,0 21,8 V L +S +C
1.8 16V	85		01.01	12.03					
1.9 dCi	75		02.01	12.03					
1.9 dTi (1U)	59		02.01	12.03					
1.9 dTi (ON)	72		01.99	12.03					
	1.4 16V (OD)	70		03.99	12.03	G1020489	23554 16,3 /WD/Acc/S LUC		
	1.6 16V (O4)	79		07.99	12.03				
	1.8 16V	85		01.01	12.03				
	1.9 dCi	75		02.01	12.03				
	1.9 dTi (1U)	59		02.01	12.03				
	1.9 dTi (ON)	72		07.99	02.01				

1) senza sensori / sans secours ABS / sin anillo sensor ABS / ohne Sensoring



**RENAULT MEGANE II Saloon 3/5-door(BM\_/CM\_) (02-08)**

	1.5 dCi	60		11.02	09.05	G1020685		23930 18,2 /Acc/S	BOS
	1.5 dCi	63		05.05	09.05				
	1.6 16V	83		11.02	09.05				
	1.9 dCi	88		11.02	09.05				
	2.0 16V	99		11.02	09.05				
	1.4 16V	72		10.05	11.08				
	1.5 dCi	60		10.05	11.08				
	1.5 dCi	63		10.05	11.08				
	1.5 dCi	76		01.07	11.08				
	1.5 dCi	78		05.05	11.08				
	1.6 16V	77		06.05	11.08				
	1.6 16V	83		10.05	11.08				
	1.6 FlexFuel	77		01.07	11.08	G2122216		260 22,0 19,8 V L +S +C	
	1.9 dCi	85		01.06	11.08				
	1.9 dCi	88		10.05	11.08				
	1.9 dCi	96		05.05	11.08				
	2.0 16V	99		10.05	11.08				
	2.0 dCi	110		09.05	11.08				
	1.4 16V	72		11.02	11.08				
	1.5 dCi	60		11.02	11.08				
	1.5 dCi	63		05.05	11.08				
	1.5 dCi	76		01.07	11.08				
	1.5 dCi	78		05.05	11.08				
	1.6 16V	77		06.05	11.08				
	1.6 16V	83		11.02	11.08	G2124158		280 24,0 21,8 V L +S +C	
	1.6 FlexFuel	77		01.07	11.08				
	1.9 dCi	85		01.06	11.08				
	1.9 dCi	88		11.02	11.08				
	1.9 dCi	96		05.05	11.08				
	2.0 16V	99		11.02	11.08				
	1.4 16V	72		11.02	11.08				
	1.5 dCi	60		11.02	11.08				
	1.5 dCi	63		05.05	11.08				
	1.5 dCi	76		01.07	11.08				
	1.5 dCi	78		05.05	11.08				
	1.6 16V	77		06.05	11.08				
	1.6 16V	83		11.02	11.08	G1020489		23554 16,3 /WD/Acc/S	LUC
	1.6 FlexFuel	77		01.07	11.08				
	1.9 dCi	85		01.06	11.08				
	1.9 dCi	88		11.02	11.08				
	1.9 dCi	96		05.05	11.08				
	2.0 16V	99		11.02	11.08				
	2.0 16V	169		08.06	11.08				
	2.0 16V Sport	165		05.04	11.08				
	2.0 16V Turbo	120		05.04	11.08				
	2.0 dCi	110		09.05	11.08				
	1.4 16V	72		11.02	11.08				
	1.5 dCi	60		11.02	11.08				
	1.5 dCi	63		05.05	11.08	G1020470	PR 1334	23482 15,8 +/WD	ATE
	1.5 dCi	76		01.07	11.08				
	1.5 dCi	78		05.05	11.08				
	1.6 16V	77		06.05	11.08				
	1.6 16V	83		11.02	11.08				
	1.6 FlexFuel	77		01.07	11.08				
	1.9 dCi	85		01.06	11.08				
	1.9 dCi	88		11.02	11.08				
	1.9 dCi	96		05.05	11.08				
	2.0 16V	99		11.02	11.08				
	2.0 16V	169		08.06	11.08				
	2.0 16V Sport	165		05.04	11.08				
2.0 16V Turbo	120		05.04	11.08					
2.0 dCi	110		09.05	11.08					

**RENAULT MEGANE II Saloon 4-door (LM\_) (03-08)**

	1.5 dCi	60		09.03	09.05	G1020685		23930 18,2 /Acc/S	BOS					
	1.5 dCi	63		05.05	09.05									
	1.5 dCi	74		02.04	09.05									
	1.5 dCi	78		05.05	09.05									
	1.6 16V	75		09.03	09.05									
	1.6 16V	77		05.05	09.05									
	1.6 16V	83		09.03	09.05									
	1.9 dCi	66		09.03	09.05									
	1.9 dCi	68		03.04	09.05									
	1.9 dCi	81		05.05	09.05									
	1.9 dCi	88		09.03	09.05									
	1.9 dCi	96		05.05	09.05									
	2.0 16V	99		09.03	09.05	G1020871		24535 18,3 +	ATE					
	1.5 dCi	60		10.05	12.08									
	1.5 dCi	63		10.05	12.08									
	1.5 dCi	74		10.05	03.06									
	1.5 dCi	76		01.07	12.08									
	1.5 dCi	78		10.05	12.08									
	1.6 16V	75		10.05	12.08									
	1.6 16V	77		10.05	12.08									
	1.6 16V	82		01.07	12.08									
	1.6 16V	83		10.05	12.08									





















**RENAULT MEGANE II Saloon 4-door (LM\_) (03-08)**

	1.9 dCi	66		10.05	12.05	G1020871		24535 18,3 +	ATE					
	1.9 dCi	68		10.05	12.08									
	1.9 dCi	81		10.05	12.08									
	1.9 dCi	88		10.05	12.08									
	1.9 dCi	96		10.05	12.08									
	2.0 16V	99		10.05	12.08									
	2.0 dCi	110		09.05	12.08									
	1.4 16V	60		09.03	08.06	G2122216		260 22,0 19,8 V L +S +C						
	1.4 16V	72		09.03	12.08									
	1.5 dCi	60		09.03	12.08	G2124158		280 24,0 21,8 V L +S +C						
	1.5 dCi	63		05.05	12.08									
	1.5 dCi	74		02.04	03.06									
	1.5 dCi	76		01.07	12.08									
	1.5 dCi	78		05.05	12.08									
	1.6 16V	75		09.03	12.08									
	1.6 16V	77		05.05	12.08									
	1.6 16V	82		01.07	12.08									
	1.6 16V	83		09.03	12.08									
	1.9 dCi	66		09.03	12.05									
	1.9 dCi	68		03.04	12.08									
	1.9 dCi	81		05.05	12.08									
	1.9 dCi	88		09.03	12.08									
	1.9 dCi	96		05.05	12.08									
	2.0 16V	99		09.03	12.08									
		1.4 16V	60		09.03					08.06	G1020489		23554 16,3 /WD/Acc/S	LUC
		1.4 16V	72		09.03					04.07				
1.5 dCi		60		09.03	04.07									
1.5 dCi		63		05.05	04.07									
1.5 dCi		74		02.04	03.06									
1.5 dCi		76		01.07	04.07									
1.5 dCi		78		05.05	04.07									
1.6 16V		75		09.03	04.07									
1.6 16V		77		05.05	04.07									
1.6 16V		82		01.07	04.07									
1.6 16V		83		09.03	04.07									
1.9 dCi		66		09.03	12.05									
1.9 dCi		68		03.04	04.07									
1.9 dCi		81		05.05	04.07									
1.9 dCi		88		09.03	04.07									
1.9 dCi		96		05.05	04.07									
2.0 16V		99		09.03	04.07									
2.0 dCi	110		09.05	04.07										
	1.4 16V	60		09.03	08.06	G1020470	PR 1334	23482 15,8 +/WD	ATE					
	1.4 16V	72		09.03	12.08									
	1.5 dCi	60		09.03	12.08									
	1.5 dCi	63		05.05	12.08									
	1.5 dCi	74		02.04	03.06									
	1.5 dCi	76		01.07	12.08									
	1.5 dCi	78		05.05	12.08									
	1.6 16V	75		09.03	12.08									
	1.6 16V	77		05.05	12.08									
	1.6 16V	82		01.07	12.08									
	1.6 16V	83		09.03	12.08									
	1.9 dCi	66		09.03	12.05									
	1.9 dCi	68		03.04	12.08									
	1.9 dCi	81		05.05	12.08									
	1.9 dCi	88		09.03	12.08									
	1.9 dCi	96		05.05	12.08									
	2.0 16V	99		09.03	12.08									
2.0 dCi	110		09.05	12.08										















**RENAULT MEGANE II Coupe/Convertible (EM\_) (03-10)**

	1.5 dCi	63		05.05	09.05	G1020685		23930 18,2 /Acc/S	BOS
	1.6 16V	77		06.05	09.05				
	1.6 16V	83		09.03	09.05				
	1.9 dCi	81		05.05	09.05				
	1.9 dCi	88		09.03	09.05				
	1.9 dCi	96		05.05	09.05				
	2.0 16V	99		09.03	09.05				
	1.5 dCi	63		10.05	04.10	G1020871		24535 18,3 +	ATE
	1.5 dCi	76		01.07	06.09				
	1.5 dCi	78		03.06	06.08				
	1.6 16V	77		10.05	04.10				
	1.6 16V	82		01.07	04.10				
	1.6 16V	83		10.05	04.10				
	1.9 dCi	81		10.05	04.10				
	1.9 dCi	85		01.06	04.10				
	1.9 dCi	88		10.05	04.10				
	1.9 dCi	96		10.05	02.07				
	2.0 16V	99		10.05	03.07				
2.0 dCi	110		09.05	04.10					
	1.5 dCi	63		05.05	04.10	G2124158		280 24,0 21,8 V L +S +C	
	1.5 dCi	76		01.07	06.09				
	1.5 dCi	78		03.06	06.08				
	1.6 16V	77		06.05	04.10				
	1.6 16V	82		01.07	04.10				
	1.6 16V	83		09.03	04.10				

							
<b>RENAULT MEGANE II Coupe/Convertible (EM_) (03-10)</b>							
	1.9 dCi	81		05.05	04.10	G2124158	280 24,0 21,8 V L +S +C
	1.9 dCi	85		01.06	04.10		
	1.9 dCi	88		09.03	04.10		
	1.9 dCi	96		05.05	02.07		
	2.0 16V	99		09.03	03.07		
	1.5 dCi	63		05.05	04.07	G1020489	23554 16,3 /WD/Acc/S LUC
	1.5 dCi	76		01.07	04.07		
	1.5 dCi	78		03.06	04.07		
	1.6 16V	77		06.05	04.07		
	1.6 16V	82		01.07	04.07		
	1.6 16V	83		09.03	04.07		
	1.9 dCi	81		05.05	04.07		
	1.9 dCi	85		01.06	04.07		
	1.9 dCi	88		09.03	04.07		
	1.9 dCi	96		05.05	02.07		
	2.0 16V	99		09.03	03.07		
	2.0 16V Turbo	120		05.04	04.07		
	2.0 dCi	110		09.05	04.07		
<b>RENAULT MEGANE II Grandtour (KM_) (03-08)</b>							
	1.4 16V	72		09.03	09.05	G1020685	23930 18,2 /Acc/S BOS
	1.5 dCi	60		09.03	09.05		
	1.5 dCi	63		05.05	09.05		
	1.5 dCi	74		02.04	09.05		
	1.5 dCi	78		05.05	09.05		
	1.6 16V	83		09.03	09.05		
	1.9 dCi	68		03.04	09.05		
	1.9 dCi	81		05.05	09.05		
	1.9 dCi	88		09.03	09.05		
	1.9 dCi	96		05.05	09.05		
	2.0 16V	99		09.03	09.05		
	1.4 16V	72		10.05	12.08	G1020871	24535 18,3 + ATE
	1.5 dCi	60		10.05	05.06		
	1.5 dCi	63		10.05	12.08		
	1.5 dCi	74		10.05	03.06		
	1.5 dCi	76		01.07	12.08		
	1.5 dCi	78		10.05	06.08		
	1.6 16V	82		01.07	12.08		
	1.6 16V	83		10.05	12.08		
	1.6 FlexFuel	77		02.08	12.08		
	1.9 dCi	68		10.05	02.07		
	1.9 dCi	81		10.05	12.08		
	1.9 dCi	88		10.05	12.08		
	1.9 dCi	96		10.05	02.07		
	2.0 16V	99		10.05	12.08		
	2.0 dCi	110		09.05	12.08		
	1.4 16V	72		09.03	12.08	G2124158	280 24,0 21,8 V L +S +C
	1.5 dCi	60		09.03	05.06		
	1.5 dCi	63		05.05	12.08		
	1.5 dCi	74		02.04	03.06		
	1.5 dCi	76		01.07	12.08		
	1.5 dCi	78		05.05	06.08		
	1.6 16V	82		01.07	12.08		
	1.6 16V	83		09.03	12.08		
	1.6 FlexFuel	77		02.08	12.08		
	1.9 dCi	68		03.04	02.07		
	1.9 dCi	81		05.05	12.08		
	1.9 dCi	88		09.03	12.08		
	1.9 dCi	96		05.05	02.07		
	2.0 16V	99		09.03	12.08		
	1.4 16V	72		09.03	04.07	G1020489	23554 16,3 /WD/Acc/S LUC
	1.5 dCi	60		09.03	05.06		
	1.5 dCi	63		05.05	04.07		
	1.5 dCi	74		02.04	03.06		
	1.5 dCi	76		01.07	04.07		
	1.5 dCi	78		05.05	04.07		
	1.6 16V	82		01.07	04.07		
	1.6 16V	83		09.03	04.07		
	1.9 dCi	68		03.04	02.07		
	1.9 dCi	81		05.05	04.07		
	1.9 dCi	88		09.03	04.07		
	1.9 dCi	96		05.05	02.07		
	2.0 16V	99		09.03	04.07		
	2.0 dCi	110		09.05	04.07		
<b>RENAULT MEGANE III Fastback (BZO_) (08-)</b>							
	1.2 TCe	85		03.12		G1201126	24538 17,9 + ATE
	1.2 TCe	97		01.13			
	1.4	96		04.09			
	1.5 dCi	63		12.09			
	1.5 dCi	66		11.08			
	1.5 dCi	78		02.09			
	1.5 dCi	81		02.09			
	1.5 dCi	96		11.08			
	1.6	74		11.08			
	1.6	81		11.08			
	1.6 16V Bifuel	81		11.08			

RENAULT MEGANE III Fastback (BZO_) (08-)									
	1.9 dCi	96		11.08		G1201126		24538 17,9 +	ATE
	2.0	103		02.09		G1020834		24709 18,6 +	ATE
	2.0 dCi	110		10.10					
	2.0 dCi	118		04.09					
	2.0 dCi	120		07.12					
	2.0 TCe	132		11.08					
	2.0 TCe	140		06.12					
	1.2 TCe	85		03.12		G2124221		280 24,0 21,8 V L +S +C	
	1.2 TCe	97		01.13					
	1.4	96		04.09					
	1.5 dCi	63		12.09					
	1.5 dCi	66		11.08					
	1.5 dCi	78		02.09					
	1.5 dCi	81		02.09					
	1.5 dCi	96		11.08					
	1.6	74		11.08					
	1.6	81		11.08					
1.6 16V Bifuel	81		11.08						
1.9 dCi	96		11.08						
	1.2 TCe	85		03.12		G1020920	- electric parking brake <sup>1)</sup>	23554 16,8 /WD/Acc/S	LUC
	1.2 TCe	97		01.13					
	1.4	96		04.09					
	1.5 dCi	63		12.09					
	1.5 dCi	66		11.08					
	1.5 dCi	78		02.09					
	1.5 dCi	81		02.09					
	1.5 dCi	96		11.08					
	1.6	74		11.08					
	1.6	81		11.08					
	1.6 16V Bifuel	81		11.08					
	1.9 dCi	96		11.08					
	2.0	103		02.09					
	2.0 dCi	110		10.10					
2.0 dCi	118		04.09						
2.0 TCe	132		11.08						
2.0 TCe	140		06.12						
RENAULT MEGANE III CC (EZO_) (10-)									
	1.2 TCe	97		04.13		G1201126		24538 17,9 +	ATE
	1.4 16V	96		06.10					
	1.5 dCi	78		06.10					
	1.5 dCi	81		06.10					
	1.6 16V	81		06.10					
	1.6 16V Bio-Petrol	81		06.10					
	1.6 dCi	96		04.11					
	1.9 dCi	96		06.10					
	2.0 16V	103		06.10					
	2.0 dCi	118		06.10		G1020834		24709 18,6 +	ATE
	2.0 TCe	132		06.10					
	1.2 TCe	97		04.13		G2124221		280 24,0 21,8 V L +S +C	
	1.4 16V	96		06.10					
	1.5 dCi	78		06.10					
	1.5 dCi	81		06.10					
	1.6 16V	81		06.10					
	1.6 16V Bio-Petrol	81		06.10					
	1.6 dCi	96		04.11					
	1.9 dCi	96		06.10					
	2.0 16V	103		06.10					
	1.2 TCe	97		04.13	- electric parking brake <sup>1)</sup>	G1020920		23554 16,8 /WD/Acc/S	LUC
	1.4 16V	96		06.10	- electric parking brake <sup>1)</sup>				
	1.5 dCi	78		06.10	- electric parking brake <sup>1)</sup>				
	1.5 dCi	81		06.10	- electric parking brake <sup>1)</sup>				
	1.6 16V	81		06.10	- electric parking brake <sup>1)</sup>				
	1.6 16V Bio-Petrol	81		06.10	- electric parking brake <sup>1)</sup>				
	1.6 dCi	96		06.10	- electric parking brake <sup>1)</sup>				
	1.9 dCi	96		06.10	- electric parking brake <sup>1)</sup>				
	2.0 16V	103		06.10	- electric parking brake <sup>1)</sup>				
	2.0 dCi	118		06.10	- electric parking brake <sup>1)</sup>				
2.0 TCe	132		06.10	- electric parking brake <sup>1)</sup>					
RENAULT MEGANE III Coupe (DZO_) (08-)									
	1.2 TCe	85		03.12		G1201126		24538 17,9 +	ATE
	1.2 TCe	97		01.13					
	1.4 16V	96		04.09					
	1.5 dCi	63		11.08					
	1.5 dCi	66		11.08					
	1.5 dCi	78		11.08					
	1.5 dCi	81		02.09					
	1.6 16V	74		11.08					
	1.6 16V	81		11.08					
	1.6 16V Bifuel	81		11.08					
	1.9 dCi	96		11.08					
	2.0 16V	103		05.09					
	2.0 dCi	110		04.09		G1020834		24709 18,6 +	ATE
	2.0 dCi	118		04.09					
2.0 dCi	120		07.12						
2.0 TCe	132		11.08						

<sup>1)</sup> - freno a mano elettrico / - frein à main électrique / - freno de mano eléctrico / - elektrische Feststellbremse

							
<b>RENAULT MEGANE III Coupe (DZO_) (08-)</b>							
	2.0 TCe	140		06.12		G1020834	24709 18,6 + ATE
	1.2 TCe	85		03.12		G2124221	280 24,0 21,8 V L +S +C
	1.2 TCe	97		01.13			
	1.4 16V	96		04.09			
	1.5 dCi	63		11.08			
	1.5 dCi	66		11.08			
	1.5 dCi	78		11.08			
	1.5 dCi	81		02.09			
	1.6 16V	74		11.08			
	1.6 16V	81		11.08			
	1.6 16V Bifuel	81		11.08			
	1.9 dCi	96		11.08			
	2.0 16V	103		05.09			
	1.2 TCe	85		03.12		G1020920	- electric parking brake <sup>1)</sup> 23554 16,8 /WD/Acc/S LUC
	1.2 TCe	97		01.13			
	1.4 16V	96		04.09			
	1.5 dCi	63		11.08			
	1.5 dCi	66		11.08			
	1.5 dCi	78		11.08			
	1.5 dCi	81		02.09			
	1.6 16V	74		11.08			
	1.6 16V	81		11.08			
	1.6 16V Bifuel	81		11.08			
	1.9 dCi	96		11.08			
	2.0 16V	103		05.09			
	2.0 dCi	110		04.09			
	2.0 dCi	118		04.09			
	2.0 TCe	132		11.08			
<b>RENAULT MEGANE III Grandtour (KZ_) (08-)</b>							
	1.2 TCe	85		03.12		G1201126	24538 17,9 + ATE
	1.2 TCe	97		01.13			
	1.4 16V	96		05.09			
	1.5 dCi	63		08.09			
	1.5 dCi	66		05.09			
	1.5 dCi	78		05.09			
	1.5 dCi	81		02.09			
	1.6 16V	74		05.09			
	1.6 16V	81		05.09			
	1.6 16V Bifuel	81		11.08			
	1.9 dCi	96		05.09			
	2.0 16V	103		05.09			
	2.0 dCi	110		08.09		G1020834	24709 18,6 + ATE
	2.0 dCi	118		04.09			
	2.0 dCi	120		07.12			
	2.0 TCe	132		05.09			
	2.0 TCe	140		09.12			
	2.0 TCe	162		09.12			
	1.2 TCe	85		03.12		G2124221	280 24,0 21,8 V L +S +C
	1.2 TCe	97		01.13			
	1.4 16V	96		05.09			
	1.5 dCi	63		08.09			
	1.5 dCi	66		05.09			
	1.5 dCi	78		05.09			
	1.5 dCi	81		02.09			
	1.6 16V	74		05.09			
	1.6 16V	81		05.09			
	1.6 16V Bifuel	81		11.08			
	1.9 dCi	96		05.09			
	2.0 16V	103		05.09			
	1.2 TCe	85		03.12		G1020920	- electric parking brake <sup>1)</sup> 23554 16,8 /WD/Acc/S LUC
	1.2 TCe	97		01.13			
	1.4 16V	96		05.09			
	1.5 dCi	63		08.09			
	1.5 dCi	66		05.09			
	1.5 dCi	78		05.09			
	1.5 dCi	81		02.09			
	1.6 16V	74		05.09			
	1.6 16V	81		05.09			
	1.6 16V Bifuel	81		11.08			
	1.9 dCi	96		05.09			
	2.0 16V	103		05.09			
	2.0 dCi	110		08.09			
	2.0 dCi	118		04.09			
	2.0 TCe	132		05.09			
	2.0 TCe	140		09.12			
	2.0 TCe	162		09.12			
<b>RENAULT MEGANE SCENIC (JA_) (96-99)</b>							
	1.4 i	51		11.96 09.98		G1020501	21463 18,2 /W/S LUC
	1.6 e	66		11.96 09.98 + manual transmission <sup>2)</sup>			
	1.6 i	55		11.96 09.98			
	1.4 i	51		10.98 09.99		G1020326	21388 18,0 +/W/S LUC
	1.6 16V	79		04.98 03.99			
	1.6 e	66		10.98 12.98 + manual transmission <sup>2)</sup>			

<sup>1)</sup> - freno a mano elettrico / - frein à main électrique / - freno de mano eléctrico / - elektrische Feststellbremse

<sup>2)</sup> + scatola cambio velocità / + transmission mécanique / + cambio de velocidad / + Schaltgetriebe



### RENAULT MEGANE SCENIC (JA\_) (96-99)

	1.6 e	66		11.96	12.98	+ autom.transmission 1)	G1020326	21388 18,0 +/W/S	LUC			
	1.6 i	55		10.98	09.99							
	1.9 D (FA0J)	47		11.96	09.98							
	1.9 D (FA0Y)	47		11.96	09.99							
	1.9 D (JA0Y)	47		11.96	09.99							
	1.9 dT	66		11.96	12.97							
	1.9 dTi (FA0N)	72		03.98	09.99							
	1.9 dTi (JA0N)	72		04.97	09.98							
	2.0 i	84		11.96	09.99							
	1.6 16V	79		04.99	09.99					G1020569	23172 18,0 /WD/Acc/S	LUC
1.6 e	66		01.99	09.99	+ manual transmission 2)							
1.6 e	66		01.99	09.99	+ autom.transmission 1)							
1.9 D (FA0J)	47		10.98	09.99								
1.9 D (JA0J)	47		11.96	09.99								
1.9 dTi (JA0N)	72		10.98	09.99								
	1.4 i	51		11.96	09.98		G2121106	259 20,6 17,7 V +S +C				
	1.6 e	66		11.96	09.98	+ manual transmission 2)						
	1.6 i	55		11.96	09.98							
	1.6 16V	79		04.98	09.98					G2122148	262 22,0 19,8 V L +S +C	
	1.6 e	66		11.96	09.98	+ autom.transmission 1)						
	1.9 D (FA0J)	47		11.96	09.98							
	1.9 D (JA0J)	47		11.96	09.98							
	1.9 D (FA0Y)	47		11.96	09.98							
	1.9 D (JA0Y)	47		11.96	09.99							
	1.9 dT	66		11.96	12.97					G2124158	280 24,0 21,8 V L +S +C	
1.9 dTi (FA0N)	72		03.98	09.98								
1.9 dTi (JA0N)	72		04.97	09.98								
2.0 i	84		11.96	09.98								
1.4 i	51		10.98	09.99								
1.6 16V	79		10.98	09.99								
1.6 e	66		10.98	09.99		G1020489	23554 16,3 /WD/Acc/S	LUC				
1.6 i	55		10.98	09.99								
1.9 D (FA0J)	47		10.98	09.99								
1.9 D (JA0J)	47		10.98	09.99								
1.9 D (FA0Y)	47		10.98	09.99								
1.9 dTi (FA0N)	72		10.98	09.99								
1.9 dTi (JA0N)	72		10.98	09.99								
2.0 i	84		10.98	09.99								
1.6 16V	79		04.98	09.99		G1020489	23554 16,3 /WD/Acc/S	LUC				
1.9 dTi (JA0N)	72		04.97	09.99	+ ABS							

### RENAULT MODUS/GRAND MODUS (JPO\_) (04-13)

	1.2	58		12.04	06.13		G1020741	23973 17,1 /Acc/S	LUC
	1.2	76		04.11	06.13				
	1.2 16V	48		05.05	06.13				
	1.2 16V	55		08.04	06.13				
	1.2 16V	74		05.07	06.13				
	1.2 16V Hi-Flex	55		10.08	06.13				
	1.4 16V	72		08.04	06.13				
	1.5 dCi	48		12.04	06.13				
	1.5 dCi	50		08.04	06.13				
	1.5 dCi	60		09.04	06.13				
	1.5 dCi	63		08.04	06.13				
	1.5 dCi	76		05.07	06.13				
	1.5 dCi	78		05.05	06.13				
	1.5 dCi 75	55		10.10	06.13				
	1.5 dCi 90	65		10.10	06.13				
	1.6 16V	65		08.04	06.13				
	1.6 16V	82		08.04	06.13				
	1.2	58		12.04	06.13		G2122216	260 22,0 19,8 V L +S +C	
	1.2	76		04.11	06.13				
	1.2 16V	48		05.05	06.13				
	1.2 16V	55		08.04	06.13				
	1.2 16V	74		05.07	06.13				
	1.2 16V Hi-Flex	55		10.08	06.13				
	1.4 16V	72		08.04	06.13				
	1.5 dCi	48		12.04	06.13				
	1.5 dCi	50		08.04	06.13				
	1.5 dCi	60		09.04	06.13				
	1.5 dCi	63		08.04	06.13				
	1.5 dCi	76		05.07	06.13				
	1.5 dCi	78		05.05	06.13				
	1.5 dCi 75	55		10.10	06.13				
	1.5 dCi 90	65		10.10	06.13				
	1.6 16V	65		08.04	06.13				
	1.6 16V	82		08.04	06.13				
	1.2	76		04.11	06.13		G1020489	23554 16,3 /WD/Acc/S	LUC
	1.2 16V	48		05.05	06.13	+ ESP			
	1.2 16V	55		08.04	06.13	+ ESP			
	1.2 16V	74		05.07	06.13	+ ESP			
	1.2 16V Hi-Flex	55		10.08	06.13	+ ESP			
	1.4 16V	72		08.04	06.13				
	1.5 dCi	50		08.04	06.13	+ ESP			
	1.5 dCi	60		09.04	06.13	+ ESP			
	1.5 dCi	63		08.04	06.13				
	↓								

1) + scatola cambio automatico / + transmission automatique / + cambio automático / + Automatikgetriebe

2) + scatola cambio velocità / + transmission mécanique / + cambio de velocidad / + Schaltgetriebe



**RENAULT MODUS/GRAND MODUS (JPO\_) (04-13)**

	1.5 dCi	76		05.07	06.13	G1020489		23554 16,3 /WD/Acc/S	LUC
	1.5 dCi	78		05.05	06.13				
	1.5 dCi 75	55		10.10	06.13				
	1.5 dCi 90	65		10.10	06.13				
	1.6 16V	65		08.04	06.13				
	1.6 16V	82		08.04	06.13				

**RENAULT R19 (3/5-door) (B53/C53/S53\_) (88-95)**

	1.2	40		09.88	12.95	G1020214 G1020501		20905 18,0 +/W/ 21463 18,2 /W/S	BDX LUC
	1.4	43		09.88	12.95				
	1.4 (B/C535)	55		09.94	12.95	G1020501		21463 18,2 /W/S	LUC
	1.7 (B/C536/E)			09.88	12.95				
	1.9 D (B/C/S531)	47		05.92	12.95				
	1.9 D (B/C534/J)	47		10.91	12.95 + ABS				
	1.9 D (B/C534/J)	47		09.88	12.95 - ABS				
	1.9 D (S534/J)	47		09.88	12.95				
	1.4 (B/C53A)	59		09.90	12.95				
	1.7 (B/C53B)	54		09.88	12.95				
	1.4 (B/C53A)	59		09.90	12.95 + manual transmission <sup>1)</sup>				
	1.4 (B/C53A)	59		09.90	12.94 + ABS/ + autom.transmission <sup>2)</sup>				
	1.4 (B/C53A)	59		09.90	12.95 - ABS				
	1.7 (B/C53B)	54		09.88	12.95 + manual transmission <sup>1)</sup>				
	1.7 (B/C53B)	54		09.88	12.94 + ABS/ + autom.transmission <sup>2)</sup>				
	1.7 (B/C53B)	54		09.88	12.95 - ABS				
	1.7 (B/C53M)	54		09.88	12.95				
	1.4 (B/C53A)	59		01.95	12.95 + ABS/ + autom.transmission <sup>2)</sup>	G1020501		21463 18,2 /W/S	LUC
	1.7 (B/C533)	54		09.88	12.95				
	1.7 (B/C53B)	54		01.95	12.95 + ABS/ + autom.transmission <sup>2)</sup>				
	1.7 (B/C53C/F)			09.88	12.95				
	1.8	65		05.92	12.95				
	1.8	66		09.94	12.95				
	1.8 (B/C538)			10.91	12.95				
	1.8 16V	99		09.88	12.95				
	1.9 D (B/C534/J)	47		09.88	09.91 + ABS				
	1.9 dT	66		09.90	12.95				
	1.9 dT (B/C53T)	66		05.92	12.95				
	1.2	40		09.88	12.95	G2112116		238 12,0 10,5 +S +C	
	1.4	43		09.88	12.95				
	1.4 (B/C535)	55		09.94	12.95				
	1.4 (B/C53A)	59		09.90	12.95 + manual transmission <sup>1)</sup>				
	1.4 (B/C53A)	59		09.90	12.94 + ABS/ + autom.transmission <sup>2)</sup>				
	1.4 (B/C53A)	59		09.90	12.95 - ABS/ + autom.transmission <sup>3)</sup>				
	1.7 (B/C536/E)			09.88	12.95				
	1.7 (B/C53B)	54		09.88	12.95 + ABS/ + manual transm. <sup>4)</sup>				
	1.7 (B/C53B)	54		09.88	12.94 + ABS/ + autom.transmission <sup>2)</sup>				
	1.7 (B/C53B)	54		09.88	12.95 - ABS/ + autom.transmission <sup>3)</sup>				
	1.9 D (B/C/S531)	47		05.92	12.95				
	1.9 D (B/C534/J)	47		10.91	12.95 + ABS				
	1.9 D (B/C534/J)	47		09.88	12.95 - ABS				
	1.9 D (S534/J)	47		09.88	12.95				
	1.7 (B/C533)	54		09.88	12.95 + manual transmission <sup>1)</sup>	G2120125		238 20,1 17,7 V +S +C	
	1.7 (B/C533)	54		09.88	12.94 + ABS/ + autom.transmission <sup>2)</sup>				
	1.7 (B/C533)	54		09.88	12.95 - ABS/ + autom.transmission <sup>3)</sup>				
	1.7 (B/C53C)	66		09.88	12.95 + manual transmission <sup>1)</sup>				
	1.7 (B/C53C)	66		09.88	12.94 + ABS/ + autom.transmission <sup>2)</sup>				
	1.7 (B/C53C)	66		09.88	12.95 - ABS/ + autom.transmission <sup>3)</sup>				
	1.7 (B/C53F)			09.90	12.95				
	1.7 (B/C53M)	54		09.88	12.95				
	1.8 (353/535F)	79		09.94	12.94 + ABS				
	1.8 (353/553F)	66		09.94	12.95 - ABS				
	1.8 (B/C53V)	66		09.94	12.94 + ABS				
	1.8 (B/C53V)	66		09.94	12.95 - ABS				
	1.8 (B/C53Y)	65		05.92	12.95 + manual transmission <sup>1)</sup>				
	1.8 4x4 (B/C53Y)	65		05.92	12.94 + ABS				
	1.8 4x4 (B/C53Y)	65		05.92	12.95 - ABS				
	1.9 D (B/C534/J)	47		09.88	09.91 + ABS				
	1.9 dT (B/C53K)	66		09.90	12.94 + ABS				
	1.9 dT (B/C53K)	66		09.90	12.95 - ABS				
	1.9 dT (B/C53T)	66		05.92	12.94 + ABS				
	1.9 dT (B/C53T)	66		05.92	12.95 - ABS				
	1.9 dT (S53K)	66		04.91	12.95				
	1.4 (B/C53A)	59		01.95	12.95 + ABS/ + autom.transmission <sup>2)</sup>	G2121106		259 20,6 17,7 V +S +C	
	1.7 (B/C533)	54		01.95	12.95 + ABS/ + autom.transmission <sup>2)</sup>				
	1.7 (B/C53C)	66		01.95	12.95 + ABS/ + autom.transmission <sup>2)</sup>				
	1.8 (353/553F)	66		01.95	12.95 + ABS				
	1.8 (353A/C/D)	66		09.94	12.95				
	1.8 (553A/C/D/H)	66		09.94	12.95				
	1.8 (B/C/538)			10.91	12.95				
	1.8 (B/C/53V)	66		01.95	12.95 + ABS				
	1.8 16V	99		09.88	12.95				
	1.8 4x4 (B/C53Y)	65		01.95	12.95 + ABS				
	1.9 dT (B/C53K)	66		01.95	12.95 + ABS				
	1.9 dT (B/C53T)	66		01.95	12.95 + ABS				

<sup>1)</sup> + scatola cambio velocità / + transmission mécanique / + cambio de velocidad / + Schaltgetriebe  
<sup>2)</sup> + ABS/ + scatola cambio autom. / + ABS/ + transmission automatique / + ABS/ + cambio automático / + ABS/ + Automatikgetriebe  
<sup>3)</sup> - ABS/ + scatola cambio autom. / - ABS/ + transmission automatique / - ABS/ + cambio automático / - ABS/ + Automatikgetriebe  
<sup>4)</sup> + ABS/ + scatola camb.velocità / + ABS/ + transmission mécanique / + ABS/ + cambio de velocidad / + ABS/ + Schaltgetriebe





### RENAULT R19 (3/5-door) (B53/C53/S53\_) (88-95)

	1.4 (B/C535)	55	09.94	12.95 + ABS	G1020777		21597 11,0 +/S	BDX
	1.7	54	09.88	12.95 + ABS				
	1.7	66	09.88	12.95 + ABS				
	1.8	65	05.92	12.95 + ABS				
	1.8	66	09.94	12.95 + ABS				
	1.8	79	09.94	12.95 + ABS				
	1.8	81	10.91	12.95 + ABS				
	1.8 16V	99	09.88	12.95				
	1.9 D	47	09.88	12.95 + ABS				
	1.9 dT	66	09.90	12.95 + ABS				
	1.4 (B/C535)	55	09.94	12.95 + ABS	G2108108	without sensor ring <sup>1)</sup>	238 8,0 7,0 +C	
	1.7 (B/C533)	54	09.88	12.95 + ABS				
	1.7 (B/C53F)		06.89	12.95 + ABS				
	1.7 (B/C53M)	54	09.88	12.95 + ABS				
	1.7 (C53C/F)		09.88	12.95 + ABS				
	1.8	79	09.94	12.95 + ABS				
	1.8	81	10.91	12.95 + ABS				
	1.8 (353/553F)	66	11.94	12.95 + ABS				
	1.8 (B/C53V)	66	09.94	12.95 + ABS				
	1.8 (B/C53Y)	65	05.92	12.95 + ABS				
	1.8 (B553A/C/D)	66	09.94	12.95 + ABS				
	1.8 (C353A/C/D)	66	09.94	12.95 + ABS				
	1.8 16V (B/C539)	99	09.88	12.95				
	1.8 16V (B/C53D)	99	05.93	12.95 + air conditioning <sup>2)</sup>				
	1.8 16V (B/C53D)	99	06.89	12.95				
	1.9 D (B/C534)	47	09.88	12.95 + ABS				
	1.9 D (B/C53I/J)	47	09.90	12.95 + ABS				
	1.9 dT (B/C53K)	66	09.90	12.95 + ABS				
	1.9 dT (B/C53T)	66	05.92	12.95 + ABS				

### RENAULT R19 CHAMADE (L53\_) (89-95)

	1.2	40	06.89	12.92	G1020214 G1020501		20905 18,0 +/WI 21463 18,2 /WI/S	BDX LUC				
	1.4		05.89	12.95								
	1.4	43	05.89	12.95								
	1.4 (L535)	55	09.94	12.95								
	1.7 (L536)	54	06.89	12.95								
	1.9 D (L534/J)	47	10.91	12.95 + ABS								
	1.9 D (L534/J)	47	05.89	12.95 - ABS								
	1.9 D (L53I)	47	05.92	12.95								
	1.4 (L53A)		09.90	12.95								
	1.7 (L53B)	54	05.89	12.95								
	1.4 (L53A)		09.90	12.95 + manual transmission <sup>3)</sup>	G1020501		21463 18,2 /WI/S	LUC				
	1.4 (L53A)		09.90	12.95 + ABS/ + autom.transmission <sup>4)</sup>								
	1.4 (L53A)		09.90	12.95 - ABS								
	1.7 (L533)	54	05.89	12.95								
	1.7 (L53B)	54	05.89	12.95 + manual transmission <sup>3)</sup>								
	1.7 (L53B)	54	05.89	12.95 + ABS/ + autom.transmission <sup>4)</sup>								
	1.7 (L53B)	54	05.89	12.95 - ABS								
	1.7 (L53C/F)		05.89	12.95								
	1.8	65	05.92	12.95								
	1.8	66	11.94	12.95								
	1.8	79	05.92	12.95								
	1.8 16V	99	05.89	12.95								
	1.9 D (L534/J)	47	05.89	09.91 + ABS								
	1.9 D (L53Z)	47	05.92	12.95								
	1.9 dT	66	04.91	12.95								
	1.9 TD (L53K)	68	09.90	04.92								
		1.2	40	06.89					12.92	G2112116		238 12,0 10,5 +S +C
		1.4	43	05.89					12.95			
		1.4 (L535)	55	09.94					12.95			
		1.4 (L53A)		09.90					12.94 + ABS/ + autom.transmission <sup>4)</sup>			
1.4 (L53A)			09.90	12.95 - ABS/ + autom.transmission <sup>5)</sup>								
1.4 (L53A)			09.90	12.95 + manual transmission <sup>3)</sup>								
1.7 (L536)		54	06.89	12.95								
1.7 (L53B)		54	05.89	12.94 + ABS/ + autom.transmission <sup>4)</sup>								
1.7 (L53B)		54	05.89	12.95 - ABS/ + autom.transmission <sup>5)</sup>								
1.7 (L53B)		54	05.89	12.95 + manual transmission <sup>3)</sup>								
1.9 D (L534/J)		47	10.91	12.95 + ABS								
1.9 D (L534/J)		47	05.89	12.95 - ABS								
1.9 D (L53I)		47	05.92	12.95								
1.7 (L533)		54	05.89	12.94 + ABS/ + autom.transmission <sup>4)</sup>								
1.7 (L533)		54	05.89	12.95 - ABS/ + autom.transmission <sup>5)</sup>								
1.7 (L533)		54	05.89	12.95 + manual transmission <sup>3)</sup>								
1.7 (L53C)		66	05.89	12.94 + ABS/ + autom.transmission <sup>4)</sup>								
1.7 (L53C)		66	05.89	12.95 - ABS/ + autom.transmission <sup>5)</sup>								
1.7 (L53C)		66	05.89	12.95 + manual transmission <sup>3)</sup>								
1.8		65	05.92	12.94 + ABS/ + autom.transmission <sup>4)</sup>								
1.8	65	05.92	12.95 - ABS/ + autom.transmission <sup>5)</sup>									
1.8	65	05.92	12.95 + manual transmission <sup>3)</sup>									
1.8 (L53V/453F)	66	09.94	12.94 + ABS									
1.8 (L53V/453F)	66	09.94	12.95 - ABS									
1.9 D (L534/J)	47	05.89	09.91 + ABS									
1.9 D (L53Z)	47	05.92	12.94 + ABS									
1.9 D (L53Z)	47	05.92	12.95 - ABS									
1.9 dT	66	04.91	12.94 + ABS									
1.9 dT	66	04.91	12.95 - ABS									
1.9 TD (L53K)	68	09.90	04.92									











<sup>1)</sup> senza sensori / sans secours ABS / sin anillo sensor ABS / ohne Sensorring

<sup>2)</sup> + aria condizionata / + air conditionné / + aire acondicionado / + Klimaanlage

<sup>3)</sup> + scatola cambio velocità / + transmission mécanique / + cambio de velocidad / + Schaltgetriebe

<sup>4)</sup> + ABS/ + scatola cambio autom. / + ABS/ + transmission automatique / + ABS/ + cambio automático / + ABS/ + Automatikgetriebe

<sup>5)</sup> - ABS/ + scatola cambio autom. / - ABS/ + transmission automatique / - ABS/ + cambio automático / - ABS/ + Automatikgetriebe

RENAULT R19 CHAMADE (L53_) (89-95)																																																																																				
	<table border="1"> <tr><td>1.4 (L53A)</td><td>54</td><td>01.95</td><td>12.95</td><td>+ ABS/ + autom.transmission 1)</td><td rowspan="15">G2121106</td><td rowspan="15">259 20,6 17,7 V +S +C</td></tr> <tr><td>1.7 (L533)</td><td>66</td><td>01.95</td><td>12.95</td><td>+ ABS/ + autom.transmission 1)</td></tr> <tr><td>1.7 (L53C)</td><td>66</td><td>01.95</td><td>12.95</td><td>+ ABS/ + autom.transmission 1)</td></tr> <tr><td>1.7 (L53F)</td><td>79</td><td>09.90</td><td>12.95</td><td></td></tr> <tr><td>1.8</td><td>65</td><td>01.95</td><td>12.95</td><td>+ ABS/ + autom.transmission 1)</td></tr> <tr><td>1.8</td><td>79</td><td>05.92</td><td>12.95</td><td></td></tr> <tr><td>1.8 (L453A/C/D/H)</td><td>66</td><td>09.94</td><td>12.95</td><td></td></tr> <tr><td>1.8 (L53V/453F)</td><td>66</td><td>01.95</td><td>12.95</td><td>+ ABS</td></tr> <tr><td>1.8 16V</td><td>99</td><td>05.89</td><td>12.95</td><td></td></tr> <tr><td>1.9 D (L53Z)</td><td>47</td><td>01.95</td><td>12.95</td><td>+ ABS</td></tr> <tr><td>1.9 dT</td><td>66</td><td>01.95</td><td>12.95</td><td>+ ABS</td></tr> </table>	1.4 (L53A)	54	01.95	12.95	+ ABS/ + autom.transmission 1)	G2121106	259 20,6 17,7 V +S +C	1.7 (L533)	66	01.95	12.95	+ ABS/ + autom.transmission 1)	1.7 (L53C)	66	01.95	12.95	+ ABS/ + autom.transmission 1)	1.7 (L53F)	79	09.90	12.95		1.8	65	01.95	12.95	+ ABS/ + autom.transmission 1)	1.8	79	05.92	12.95		1.8 (L453A/C/D/H)	66	09.94	12.95		1.8 (L53V/453F)	66	01.95	12.95	+ ABS	1.8 16V	99	05.89	12.95		1.9 D (L53Z)	47	01.95	12.95	+ ABS	1.9 dT	66	01.95	12.95	+ ABS																										
1.4 (L53A)	54	01.95	12.95	+ ABS/ + autom.transmission 1)	G2121106	259 20,6 17,7 V +S +C																																																																														
1.7 (L533)	66	01.95	12.95	+ ABS/ + autom.transmission 1)																																																																																
1.7 (L53C)	66	01.95	12.95	+ ABS/ + autom.transmission 1)																																																																																
1.7 (L53F)	79	09.90	12.95																																																																																	
1.8	65	01.95	12.95	+ ABS/ + autom.transmission 1)																																																																																
1.8	79	05.92	12.95																																																																																	
1.8 (L453A/C/D/H)	66	09.94	12.95																																																																																	
1.8 (L53V/453F)	66	01.95	12.95	+ ABS																																																																																
1.8 16V	99	05.89	12.95																																																																																	
1.9 D (L53Z)	47	01.95	12.95	+ ABS																																																																																
1.9 dT	66	01.95	12.95	+ ABS																																																																																
	<table border="1"> <tr><td>1.4</td><td>55</td><td>09.90</td><td>12.95</td><td>+ ABS</td><td rowspan="11">G1020777</td><td rowspan="11">21597 11,0 +/-S</td><td rowspan="11">BDX</td></tr> <tr><td>1.7</td><td>54</td><td>05.89</td><td>12.95</td><td>+ ABS</td></tr> <tr><td>1.7</td><td>66</td><td>05.89</td><td>12.95</td><td>+ ABS</td></tr> <tr><td>1.8</td><td>65</td><td>07.91</td><td>12.95</td><td>+ ABS</td></tr> <tr><td>1.8</td><td>66</td><td>09.94</td><td>12.95</td><td>+ ABS</td></tr> <tr><td>1.8</td><td>79</td><td>05.92</td><td>12.95</td><td>+ ABS</td></tr> <tr><td>1.8 16V</td><td>99</td><td>05.89</td><td>12.95</td><td></td></tr> <tr><td>1.9 D</td><td>47</td><td>05.89</td><td>12.95</td><td>+ ABS</td></tr> <tr><td>1.9 dT</td><td>66</td><td>04.91</td><td>12.95</td><td>+ ABS</td></tr> <tr><td>1.9 TD (L53K)</td><td>68</td><td>09.90</td><td>04.92</td><td></td></tr> </table>	1.4	55	09.90					12.95	+ ABS	G1020777	21597 11,0 +/-S	BDX	1.7	54	05.89	12.95	+ ABS	1.7	66	05.89	12.95	+ ABS	1.8	65	07.91	12.95	+ ABS	1.8	66	09.94	12.95	+ ABS	1.8	79	05.92	12.95	+ ABS	1.8 16V	99	05.89	12.95		1.9 D	47	05.89	12.95	+ ABS	1.9 dT	66	04.91	12.95	+ ABS	1.9 TD (L53K)	68	09.90	04.92																											
1.4	55	09.90	12.95	+ ABS					G1020777	21597 11,0 +/-S				BDX																																																																						
1.7	54	05.89	12.95	+ ABS																																																																																
1.7	66	05.89	12.95	+ ABS																																																																																
1.8	65	07.91	12.95	+ ABS																																																																																
1.8	66	09.94	12.95	+ ABS																																																																																
1.8	79	05.92	12.95	+ ABS																																																																																
1.8 16V	99	05.89	12.95																																																																																	
1.9 D	47	05.89	12.95	+ ABS																																																																																
1.9 dT	66	04.91	12.95	+ ABS																																																																																
1.9 TD (L53K)	68	09.90	04.92																																																																																	
	<table border="1"> <tr><td>1.4</td><td>55</td><td>09.90</td><td>12.95</td><td>+ ABS</td><td rowspan="17">G2108108</td><td rowspan="17">without sensor ring 2)</td><td rowspan="17">238 8,0 7,0 +C</td></tr> <tr><td>1.7</td><td>54</td><td>05.89</td><td>12.95</td><td>+ ABS</td></tr> <tr><td>1.7 (L53C)</td><td>66</td><td>05.89</td><td>12.95</td><td>+ ABS</td></tr> <tr><td>1.7 (L53F)</td><td>79</td><td>09.90</td><td>12.95</td><td>+ ABS</td></tr> <tr><td>1.8</td><td>65</td><td>05.92</td><td>12.95</td><td>+ ABS</td></tr> <tr><td>1.8</td><td>79</td><td>05.92</td><td>12.95</td><td>+ ABS</td></tr> <tr><td>1.8 (L453A/C/D)</td><td>66</td><td>09.94</td><td>12.95</td><td>+ ABS</td></tr> <tr><td>1.8 (L53V/453F)</td><td>66</td><td>09.94</td><td>12.95</td><td>+ ABS</td></tr> <tr><td>1.8 16V (L539)</td><td>99</td><td>05.89</td><td>12.95</td><td></td></tr> <tr><td>1.8 16V (L53D)</td><td>99</td><td>05.93</td><td>12.95</td><td>+ ABS/ + air conditioning 3)</td></tr> <tr><td>1.8 16V (L53D)</td><td>99</td><td>06.89</td><td>04.93</td><td>+ ABS</td></tr> <tr><td>1.9 D (L534)</td><td>47</td><td>05.89</td><td>12.95</td><td>+ ABS</td></tr> <tr><td>1.9 D (L53I/J)</td><td>47</td><td>09.90</td><td>12.95</td><td>+ ABS</td></tr> <tr><td>1.9 D (L53Z)</td><td>47</td><td>05.92</td><td>12.95</td><td>+ ABS</td></tr> <tr><td>1.9 dT</td><td>66</td><td>04.91</td><td>12.95</td><td>+ ABS</td></tr> <tr><td>1.9 TD (L53K)</td><td>68</td><td>09.90</td><td>04.92</td><td></td></tr> </table>	1.4	55	09.90	12.95	+ ABS	G2108108	without sensor ring 2)			238 8,0 7,0 +C	1.7	54		05.89	12.95	+ ABS	1.7 (L53C)	66	05.89	12.95	+ ABS	1.7 (L53F)	79	09.90	12.95	+ ABS	1.8	65	05.92	12.95	+ ABS	1.8	79	05.92	12.95	+ ABS	1.8 (L453A/C/D)	66	09.94	12.95	+ ABS	1.8 (L53V/453F)	66	09.94	12.95	+ ABS	1.8 16V (L539)	99	05.89	12.95		1.8 16V (L53D)	99	05.93	12.95	+ ABS/ + air conditioning 3)	1.8 16V (L53D)	99	06.89	04.93	+ ABS	1.9 D (L534)	47	05.89	12.95	+ ABS	1.9 D (L53I/J)	47	09.90	12.95	+ ABS	1.9 D (L53Z)	47	05.92	12.95	+ ABS	1.9 dT	66	04.91	12.95	+ ABS	1.9 TD (L53K)	68
1.4	55	09.90	12.95	+ ABS	G2108108	without sensor ring 2)			238 8,0 7,0 +C																																																																											
1.7	54	05.89	12.95	+ ABS																																																																																
1.7 (L53C)	66	05.89	12.95	+ ABS																																																																																
1.7 (L53F)	79	09.90	12.95	+ ABS																																																																																
1.8	65	05.92	12.95	+ ABS																																																																																
1.8	79	05.92	12.95	+ ABS																																																																																
1.8 (L453A/C/D)	66	09.94	12.95	+ ABS																																																																																
1.8 (L53V/453F)	66	09.94	12.95	+ ABS																																																																																
1.8 16V (L539)	99	05.89	12.95																																																																																	
1.8 16V (L53D)	99	05.93	12.95	+ ABS/ + air conditioning 3)																																																																																
1.8 16V (L53D)	99	06.89	04.93	+ ABS																																																																																
1.9 D (L534)	47	05.89	12.95	+ ABS																																																																																
1.9 D (L53I/J)	47	09.90	12.95	+ ABS																																																																																
1.9 D (L53Z)	47	05.92	12.95	+ ABS																																																																																
1.9 dT	66	04.91	12.95	+ ABS																																																																																
1.9 TD (L53K)	68	09.90	04.92																																																																																	
RENAULT R19 Convertible (D53_) (91-96)																																																																																				
	<table border="1"> <tr><td>1.7</td><td></td><td>02.91</td><td>08.96</td><td></td><td rowspan="5">G1020501</td><td rowspan="5">21463 18,2 /W/S</td><td rowspan="5">LUC</td></tr> <tr><td>1.8</td><td>65</td><td>04.92</td><td>12.94</td><td></td></tr> <tr><td>1.8</td><td>66</td><td>01.93</td><td>12.94</td><td></td></tr> <tr><td>1.8</td><td>79</td><td>09.94</td><td>08.96</td><td></td></tr> <tr><td>1.8 16V</td><td></td><td>02.91</td><td>03.95</td><td></td></tr> </table>	1.7		02.91	08.96		G1020501	21463 18,2 /W/S	LUC	1.8	65	04.92	12.94		1.8	66	01.93	12.94		1.8	79	09.94	08.96		1.8 16V		02.91	03.95																																																								
1.7		02.91	08.96		G1020501	21463 18,2 /W/S				LUC																																																																										
1.8	65	04.92	12.94																																																																																	
1.8	66	01.93	12.94																																																																																	
1.8	79	09.94	08.96																																																																																	
1.8 16V		02.91	03.95																																																																																	
	<table border="1"> <tr><td>1.7</td><td></td><td>02.91</td><td>08.96</td><td>+ manual transmission 4)</td><td rowspan="8">G2120125</td><td rowspan="8">238 20,1 17,7 V +S +C</td></tr> <tr><td>1.7</td><td></td><td>02.91</td><td>12.94</td><td>+ ABS/ + autom.transmission 1)</td></tr> <tr><td>1.7</td><td></td><td>02.91</td><td>08.96</td><td>- ABS/ + autom.transmission 5)</td></tr> <tr><td>1.8</td><td>65</td><td>04.92</td><td>12.94</td><td>+ manual transmission 4)</td></tr> <tr><td>1.8</td><td>65</td><td>04.92</td><td>12.94</td><td>+ ABS/ + autom.transmission 1)</td></tr> <tr><td>1.8</td><td>65</td><td>04.92</td><td>12.94</td><td>- ABS/ + autom.transmission 5)</td></tr> <tr><td>1.8 (853A)</td><td>66</td><td>01.93</td><td>08.96</td><td>- ABS</td></tr> </table>	1.7		02.91	08.96	+ manual transmission 4)	G2120125	238 20,1 17,7 V +S +C	1.7		02.91	12.94	+ ABS/ + autom.transmission 1)	1.7		02.91	08.96	- ABS/ + autom.transmission 5)	1.8	65	04.92	12.94	+ manual transmission 4)	1.8	65	04.92	12.94	+ ABS/ + autom.transmission 1)	1.8	65	04.92	12.94	- ABS/ + autom.transmission 5)	1.8 (853A)	66	01.93	08.96	- ABS																																														
1.7		02.91	08.96	+ manual transmission 4)	G2120125	238 20,1 17,7 V +S +C																																																																														
1.7		02.91	12.94	+ ABS/ + autom.transmission 1)																																																																																
1.7		02.91	08.96	- ABS/ + autom.transmission 5)																																																																																
1.8	65	04.92	12.94	+ manual transmission 4)																																																																																
1.8	65	04.92	12.94	+ ABS/ + autom.transmission 1)																																																																																
1.8	65	04.92	12.94	- ABS/ + autom.transmission 5)																																																																																
1.8 (853A)	66	01.93	08.96	- ABS																																																																																
	<table border="1"> <tr><td>1.7</td><td></td><td>01.95</td><td>08.96</td><td>+ ABS/ + autom.transmission 1)</td><td rowspan="4">G2121106</td><td rowspan="4">259 20,6 17,7 V +S +C</td></tr> <tr><td>1.8</td><td>66</td><td>01.93</td><td>08.96</td><td>+ ABS</td></tr> <tr><td>1.8</td><td>79</td><td>09.94</td><td>08.96</td><td></td></tr> <tr><td>1.8 16V</td><td></td><td>02.91</td><td>03.95</td><td></td></tr> </table>	1.7		01.95			08.96	+ ABS/ + autom.transmission 1)	G2121106	259 20,6 17,7 V +S +C	1.8	66	01.93	08.96	+ ABS	1.8	79	09.94	08.96		1.8 16V		02.91	03.95																																																												
1.7		01.95	08.96	+ ABS/ + autom.transmission 1)	G2121106	259 20,6 17,7 V +S +C																																																																														
1.8	66	01.93	08.96	+ ABS																																																																																
1.8	79	09.94	08.96																																																																																	
1.8 16V		02.91	03.95																																																																																	
	<table border="1"> <tr><td>1.7</td><td></td><td>02.91</td><td>08.96</td><td>+ ABS</td><td rowspan="5">G1020777</td><td rowspan="5">21597 11,0 +/-S</td><td rowspan="5">BDX</td></tr> <tr><td>1.8</td><td>65</td><td>04.92</td><td>12.95</td><td>+ ABS</td></tr> <tr><td>1.8</td><td>66</td><td>01.93</td><td>08.96</td><td>+ ABS</td></tr> <tr><td>1.8 (853F)</td><td>79</td><td>09.94</td><td>08.96</td><td>+ ABS</td></tr> <tr><td>1.8 16V</td><td></td><td>02.91</td><td>03.95</td><td></td></tr> </table>	1.7		02.91	08.96	+ ABS	G1020777	21597 11,0 +/-S	BDX	1.8	65	04.92	12.95	+ ABS	1.8	66	01.93	08.96	+ ABS	1.8 (853F)	79	09.94	08.96	+ ABS	1.8 16V		02.91	03.95																																																								
1.7		02.91	08.96	+ ABS	G1020777	21597 11,0 +/-S				BDX																																																																										
1.8	65	04.92	12.95	+ ABS																																																																																
1.8	66	01.93	08.96	+ ABS																																																																																
1.8 (853F)	79	09.94	08.96	+ ABS																																																																																
1.8 16V		02.91	03.95																																																																																	
	<table border="1"> <tr><td>1.7</td><td></td><td>02.91</td><td>08.96</td><td>+ ABS</td><td rowspan="5">G2108108</td><td rowspan="5">without sensor ring 2)</td><td rowspan="5">238 8,0 7,0 +C</td></tr> <tr><td>1.8</td><td>65</td><td>04.92</td><td>12.94</td><td>+ ABS</td></tr> <tr><td>1.8</td><td>66</td><td>01.93</td><td>08.96</td><td>+ ABS</td></tr> <tr><td>1.8 (853F)</td><td>79</td><td>09.94</td><td>08.96</td><td>+ ABS</td></tr> <tr><td>1.8 16V</td><td></td><td>02.91</td><td>03.95</td><td></td></tr> </table>	1.7		02.91	08.96	+ ABS	G2108108	without sensor ring 2)	238 8,0 7,0 +C	1.8	65	04.92	12.94	+ ABS	1.8	66	01.93	08.96	+ ABS	1.8 (853F)	79	09.94	08.96	+ ABS	1.8 16V		02.91	03.95																																																								
1.7		02.91	08.96	+ ABS	G2108108	without sensor ring 2)				238 8,0 7,0 +C																																																																										
1.8	65	04.92	12.94	+ ABS																																																																																
1.8	66	01.93	08.96	+ ABS																																																																																
1.8 (853F)	79	09.94	08.96	+ ABS																																																																																
1.8 16V		02.91	03.95																																																																																	
RENAULT R21 NEVADA (K48_) (86-95)																																																																																				
	<table border="1"> <tr><td>1.7 (K/S 481)</td><td>55</td><td>07.86</td><td>12.95</td><td></td><td rowspan="2">G1020214 G1020501</td><td rowspan="2">20905 18,0 +/-W/ 21463 18,2 /W/S</td><td rowspan="2">BDX LUC</td></tr> <tr><td>1.7 i (K 48F)</td><td>54</td><td>07.86</td><td>12.95</td><td></td></tr> <tr><td>1.9 D (K 48I)</td><td>47</td><td>04.92</td><td>12.95</td><td></td></tr> <tr><td>1.9 D (K/S 48H)</td><td>47</td><td>05.89</td><td>12.95</td><td></td></tr> </table>	1.7 (K/S 481)	55	07.86	12.95		G1020214 G1020501	20905 18,0 +/-W/ 21463 18,2 /W/S	BDX LUC	1.7 i (K 48F)	54	07.86	12.95		1.9 D (K 48I)	47	04.92	12.95		1.9 D (K/S 48H)	47	05.89	12.95																																																													
1.7 (K/S 481)	55	07.86	12.95		G1020214 G1020501	20905 18,0 +/-W/ 21463 18,2 /W/S				BDX LUC																																																																										
1.7 i (K 48F)	54	07.86	12.95																																																																																	
1.9 D (K 48I)	47	04.92	12.95																																																																																	
1.9 D (K/S 48H)	47	05.89	12.95																																																																																	
	<table border="1"> <tr><td>1.6 (U)</td><td></td><td>06.88</td><td>12.95</td><td></td><td rowspan="8">G1020501</td><td rowspan="8">21463 18,2 /W/S</td><td rowspan="8">LUC</td></tr> <tr><td>1.7 (K 484)</td><td></td><td>06.90</td><td>12.95</td><td></td></tr> <tr><td>1.7 (K 48J)</td><td></td><td>07.86</td><td>12.95</td><td></td></tr> <tr><td>1.7 (K 48M)</td><td>54</td><td>10.87</td><td>12.95</td><td></td></tr> <tr><td>1.7 (K 48N)</td><td>64</td><td>10.87</td><td>12.95</td><td></td></tr> <tr><td>1.7 (K/S 482)</td><td>65</td><td>07.86</td><td>12.95</td><td></td></tr> <tr><td>1.7 i (K 48E)</td><td></td><td>07.86</td><td>12.95</td><td></td></tr> </table>	1.6 (U)		06.88	12.95		G1020501	21463 18,2 /W/S	LUC	1.7 (K 484)		06.90	12.95		1.7 (K 48J)		07.86	12.95		1.7 (K 48M)	54	10.87	12.95		1.7 (K 48N)	64	10.87	12.95		1.7 (K/S 482)	65	07.86	12.95		1.7 i (K 48E)		07.86	12.95																																														
1.6 (U)		06.88	12.95		G1020501	21463 18,2 /W/S				LUC																																																																										
1.7 (K 484)		06.90	12.95																																																																																	
1.7 (K 48J)		07.86	12.95																																																																																	
1.7 (K 48M)	54	10.87	12.95																																																																																	
1.7 (K 48N)	64	10.87	12.95																																																																																	
1.7 (K/S 482)	65	07.86	12.95																																																																																	
1.7 i (K 48E)		07.86	12.95																																																																																	
	<table border="1"> <tr><td>1.6 (U)</td><td></td><td>06.88</td><td>12.95</td><td></td><td rowspan="8">G2120125</td><td rowspan="8">238 20,1 17,7 V +S +C</td></tr> <tr><td>1.7 (K 484)</td><td></td><td>06.90</td><td>12.95</td><td></td></tr> <tr><td>1.7 (K 48J)</td><td></td><td>07.86</td><td>12.95</td><td></td></tr> <tr><td>1.7 (K 48M)</td><td>54</td><td>10.87</td><td>12.95</td><td></td></tr> <tr><td>1.7 (K 48N)</td><td>64</td><td>10.87</td><td>12.95</td><td></td></tr> <tr><td>1.7 (K/S 481)</td><td>55</td><td>07.86</td><td>12.95</td><td></td></tr> <tr><td>1.7 (K/S 482)</td><td>65</td><td>07.86</td><td>12.95</td><td></td></tr> <tr><td>1.7 i (K 48E)</td><td></td><td>07.86</td><td>12.95</td><td></td></tr> </table>	1.6 (U)		06.88			12.95		G2120125		238 20,1 17,7 V +S +C	1.7 (K 484)		06.90	12.95		1.7 (K 48J)		07.86	12.95		1.7 (K 48M)	54	10.87	12.95		1.7 (K 48N)	64	10.87	12.95		1.7 (K/S 481)	55	07.86	12.95		1.7 (K/S 482)	65	07.86	12.95		1.7 i (K 48E)		07.86	12.95																																							
1.6 (U)		06.88	12.95		G2120125	238 20,1 17,7 V +S +C																																																																														
1.7 (K 484)		06.90	12.95																																																																																	
1.7 (K 48J)		07.86	12.95																																																																																	
1.7 (K 48M)	54	10.87	12.95																																																																																	
1.7 (K 48N)	64	10.87	12.95																																																																																	
1.7 (K/S 481)	55	07.86	12.95																																																																																	
1.7 (K/S 482)	65	07.86	12.95																																																																																	
1.7 i (K 48E)		07.86	12.95																																																																																	

1) + ABS/ + scatola cambio autom. / + ABS/ + transmission automatique / + ABS/ + cambio automático / + ABS/ + Automatikgetriebe

















2) senza sensori / sans secours ABS / sin anillo sensor ABS / ohne Sensoring

3) + ABS/ + aria condizionata / + ABS/ + air conditionné / + ABS/ + aire acondicionado / + ABS/ + Klimaanlage

4) + scatola cambio velocità / + transmission mécanique / + cambio de velocidad / + Schaltgetriebe















5) - ABS/ + scatola cambio autom. / - ABS/ + transmission automatique / - ABS/ + cambio automático / - ABS/ + Automatikgetriebe



							
<b>RENAULT R21 NEVADA (K48_) (86-95)</b>							
	1.7 i (K 48F)	54		07.86	12.95	G2120125	238 20,1 17,7 V +S +C
	1.9 D (K 48I)	47		04.92	12.95		
	1.9 D (K/S 48H)	47		05.89	12.95		
	2.0 i (K 483)	85		07.86	12.95 + ABS	G1020327	20410 15,0 + BRE
	2.0 i (K 48C)	88		06.90	12.95 + ABS		
	2.0 i (K 48R)	99		07.91	12.95 + ABS		
	2.1 D (K 480)	51		04.92	12.95 + ABS		
	2.1 TD (K 487)	65		06.91	12.95 + ABS		
	2.2 i (K 48B)	79		04.93	12.95 + ABS		
	2.2 i (K 48K)	79		07.86	12.95 + ABS		
<b>RENAULT SAFRANE (B54_) (92-00)</b>							
	2.0 i (B540)	77		09.92	07.96	G1020326	21388 18,0 +/M/S LUC
	2.0 i (B542)	97		04.92	07.96		
	2.0 i (B54L)	100		08.96	12.00		
	2.1 dT	65		11.93	07.96		
	2.2 dT	83		08.96	12.00		
	2.2 i (B541)	79		04.92	07.96		
	2.2 i (B543)	101		04.92	07.96		
	2.5 20V	121		08.96	12.00		
	2.5 dT	83		12.92	07.96		
	3.0 V6	123		08.96	12.00		
	3.0 V6 (B544/B/J)	123		12.92	07.96		
	3.0 V6	140		03.99	12.00	G1020569	23172 18,0 /WD/Acc/S LUC
	2.0 i (B540)	77		09.92	07.96	G2122148	262 22,0 19,8 V L +S +C
	2.0 i (B542/E)	97		04.92	01.95		
	2.1 dT	65		11.93	07.96		
	2.2 i (B541)	79		04.92	01.95 + ⊕		
	2.2 i (B541)	79		02.95	07.96 - ⊖		
	2.2 i (B543)	101		04.92	01.95		
	2.0 i (B54L)	100		01.98	12.00	G2124171	280 24,0 21,8 V L +S +C
	2.2 dT	83		08.96	12.00		
	2.5 20V	121		08.96	12.00		
	2.5 dT	83		06.94	07.96 + manual transmission <sup>1)</sup>		
	2.5 dT	83		07.93	07.96 + autom.transmission <sup>2)</sup>		
	3.0 V6	123		08.96	12.00		
	3.0 V6 (B544/B/J)	123		12.92	07.96		
	3.0 V6	140		03.99	12.00	G2124171	280 24,0 21,8 V L +S +C
	2.0 i (B540)	77		02.95	07.96	G1020327	20410 15,0 + BRE
	2.0 i (B540)	77		09.92	01.95 + ABS		
	2.0 i (B542/E)	97		04.92	07.96		
	2.0 i (B54L)	100		08.96	12.00		
	2.1 dT	65		02.95	07.96		
	2.1 dT	65		11.93	01.95 + ABS		
	2.2 dT	83		08.96	12.00		
	2.2 i (B541)	79		02.95	07.96		
	2.2 i (B541)	79		04.92	01.95 + ABS		
	2.2 i (B543)	101		04.92	07.96		
	2.5 20V	121		08.96	12.00		
	2.5 dT	83		12.92	07.96		
	3.0 V6	123		08.96	12.00		
	3.0 V6	140		03.99	12.00		
	3.0 V6 (B544)	123		12.92	07.96		
	3.0 V6 (B54B/J)	123		12.92	07.96		
<b>RENAULT SANDERO (BSO_) (07-)</b>							
	1.4	55		02.09		G1020501	21463 18,2 /M/S LUC
	1.6	62		11.10			
	1.6	64		02.09			
	1.6	66		05.09			
	1.6	75		12.07			
	1.4	55		02.09	- ABS	G2112116	238 12,0 10,5 +S +C
	1.6	62		11.10	- ABS		
	1.6	64		02.09	- ABS		
	1.6	66		05.09	- ABS		
	1.6	75		12.07	- ABS		
	1.4	55		02.09	+ ABS	G2112171	259 12,0 10,6 +S +C
	1.6	62		11.10	+ ABS		
	1.6	64		02.09	+ ABS		
	1.6	66		05.09	+ ABS		
	1.6	75		12.07	+ ABS		
	1.4	55		02.09		G2121106	259 20,6 17,7 V +S +C
	1.6	62		11.10			
	1.6	64		02.09			
	1.6	66		05.09			
	1.6	75		12.07			
<b>RENAULT SCENIC I (JA_) (99-03)</b>							
	1.4 16V (0D,1H,0W,10)	70		09.99	06.03	G1020569	23172 18,0 /WD/Acc/S LUC
	1.6 16V (JA0B,04,11)	79		09.99	06.03		
	1.8 16V (12,1R,1M,1A)	85		01.01	06.03		
	1.8 16V 4x4	85		07.00	06.03		
	1.9 dCi (JA01,05,1F)	75		09.99	06.03		
	1.9 dCi RX4	75		11.00	03.02		
	1.9 dTi (JA0N)	72		09.99	06.03		
	1.9 dTi (JA1U)	59		01.01	06.03		

<sup>1)</sup> + scatola cambio velocità / + transmission mécanique / + cambio de velocidad / + Schaltgetriebe

<sup>2)</sup> + scatola cambio automatico / + transmission automatique / + cambio automático / + Automatikgetriebe

											
<b>RENAULT SCENIC I (JA_) (99-03)</b>											
	2.0 16V (1B,1D,0C)	102		06.00	06.03	G1020569	23172 18,0 /WD/Acc/S	LUC			
	2.0 16V IDE	103		09.99	06.03						
	2.0 16V RX4	102		06.00	03.02						
	1.9 dCi RX4	75		04.02	03.06						
	2.0 16V RX4	102		04.02	03.06	G1020547	23245 18,3 +	ATE			
	1.4 16V (0D,1H,0W,10)	70		09.99	06.03	G2124158	280 24,0 21,8 V L +S +C				
	1.6 16V (JA0B,04,11)	79		09.99	06.03						
	1.8 16V (12,1R,1M,1A)	85		01.01	06.03						
	1.8 16V 4x4	85		07.00	06.03						
	1.9 dCi (JA01,05,1F)	75		09.99	06.03						
	1.9 dTi (JA0N)	72		09.99	06.03						
	1.9 dTi (JA1U)	59		01.01	06.03						
	2.0 16V (1B,1D,0C)	102		06.00	06.03						
	2.0 16V IDE	103		09.99	06.03						
	1.9 dCi RX4	75		11.00	02.02				G2124171	280 24,0 21,8 V L +S +C	
	2.0 16V RX4	102		06.00	02.02						
	1.4 16V (0D,1H,0W,10)	70		09.99	06.03	G1020489	23554 16,3 /WD/Acc/S	LUC			
	1.6 16V (JA0B,04,11)	79		09.99	06.03						
	1.8 16V (12,1R,1M,1A)	85		01.01	06.03						
	1.9 dCi (JA01,05,1F)	75		09.99	06.03						
	1.9 dTi (JA0N)	72		09.99	06.03						
	1.9 dTi (JA1U)	59		01.01	06.03						
	2.0 16V (1B,1D,0C)	102		06.00	06.03						
	2.0 16V IDE	103		09.99	06.03						
<b>RENAULT SCENIC II (JM_) (03-09)</b>											
	1.4 16V	72		06.03	09.05	G1020685	23930 18,2 /Acc/S	BOS			
	1.5 dCi	60		06.03	09.05						
	1.5 dCi	63		05.05	09.05						
	1.5 dCi	74		11.03	09.05						
	1.5 dCi	78		05.05	09.05						
	1.6 16V	83		06.03	09.05						
	1.9 dCi	81		05.05	09.05						
	1.9 dCi	88		06.03	09.05						
	1.9 dCi	96		05.05	09.05						
	2.0 16V	99		06.03	09.05						
	1.4 16V	72		10.05	03.09				G1020871	24535 18,3 +	ATE
	1.5 dCi	60		10.05	03.09						
	1.5 dCi	63		10.05	03.09						
	1.5 dCi	74		10.05	03.09						
1.5 dCi	76		01.07	03.09							
1.5 dCi	78		10.05	03.09							
1.6 16V	82		01.07	03.09	G1020867	23245 18,3 +	ATE				
1.6 16V	83		10.05	03.09							
1.9 D	85		06.06	03.09							
1.9 dCi	81		10.05	03.09							
1.9 dCi	88		10.05	03.09							
1.9 dCi	96		10.05	03.09							
2.0 16V	99		10.05	03.09							
2.0 dCi	110		09.05	03.09							
	1.4 16V	72		06.03	03.09	G2124158	280 24,0 21,8 V L +S +C				
	1.5 dCi	60		06.03	03.09						
	1.5 dCi	63		05.05	03.09						
	1.5 dCi	74		11.03	03.09						
	1.5 dCi	76		01.07	03.09						
	1.5 dCi	78		05.05	03.09						
	1.6 16V	82		01.07	03.09						
	1.6 16V	83		06.03	03.09						
	1.9 D	85		06.06	03.09				G2124191	300 24,0 21,8 V L +S +C	
	1.9 dCi	81		05.05	03.09						
1.9 dCi	88		06.03	03.09							
1.9 dCi	96		05.05	03.09							
2.0 16V	99		06.03	03.09							
	1.4 16V	72		06.03	03.09	G1020489	23554 16,3 /WD/Acc/S	LUC			
	1.5 dCi	60		06.03	03.09						
	1.5 dCi	63		05.05	03.09						
	1.5 dCi	74		11.03	03.09						
	1.5 dCi	76		01.07	03.09						
	1.5 dCi	78		05.05	03.09						
	1.6 16V	82		01.07	03.09						
	1.6 16V	83		06.03	03.09						
	1.9 D	85		06.06	03.09						
	1.9 dCi	81		05.05	03.09						
	1.9 dCi	88		06.03	03.09						
	1.9 dCi	96		05.05	03.09						
2.0 16V	99		06.03	03.09							
2.0 16V Turbo	120		05.04	03.09							
2.0 dCi	110		09.05	03.09							
<b>RENAULT SCENIC III (JZ_) (09-)</b>											
	1.5 dCi	63		04.09	+ 15" wheel <sup>1)</sup>	G1201126	24538 17,9 +	ATE			
	1.5 dCi	70		11.10	+ 15" wheel <sup>1)</sup>						
	1.5 dCi	78		04.09	+ 15" wheel <sup>1)</sup>						
	1.5 dCi	81		04.09	+ 15" wheel <sup>1)</sup>						
	1.6 16V	81		04.09	+ 15" wheel <sup>1)</sup>						
	1.6 E85	81		06.09	+ 15" wheel <sup>1)</sup>						

<sup>1)</sup> + ruota 15" / + roue 15" / + rueda 15" / + 15" Rad



















RENAULT SCENIC III (JZ_) (09-)											
	1.2 TCe	85		03.12				G1020834		24709 18,6 +	ATE
	1.2 TCe	97		03.13							
	1.4 TCe	96		04.09							
	1.5 dCi	70		11.10		+ 16"/17" wheel <sup>1)</sup>					
	1.5 dCi	78		04.09		+ 16"/17" wheel <sup>1)</sup>					
	1.5 dCi	81		04.09		+ 16"/17" wheel <sup>1)</sup>					
	1.6 16V	81		04.09		+ 16"/17" wheel <sup>1)</sup>					
	1.6 dCi	96		04.11							
	1.6 E85	81		06.09		+ 16"/17" wheel <sup>1)</sup>					
	1.9 dCi	96		04.09							
	2.0 16V	103		04.09							
	2.0 dCi	110		04.09							
	2.0 dCi	118		04.09							
	1.5 dCi	63		04.09		+ 15" wheel <sup>2)</sup>		G2124221		280 24,0 21,8 V L +S +C	
	1.5 dCi	70		04.09		+ 15" wheel <sup>2)</sup>					
	1.5 dCi	78		04.09		+ 15" wheel <sup>2)</sup>					
	1.5 dCi	81		04.09		+ 15" wheel <sup>2)</sup>					
	1.6 16V	81		04.09		+ 15" wheel <sup>2)</sup>					
	1.6 E85	81		06.09		+ 15" wheel <sup>2)</sup>					
	1.2 TCe	85		03.12		- electric parking brake <sup>3)</sup>		G1020920		23554 16,8 /WD/Acc/S	LUC
	1.2 TCe	97		03.13		- electric parking brake <sup>3)</sup>					
	1.4 TCe	96		04.09		- electric parking brake <sup>3)</sup>					
	1.5 dCi	63		04.09		- electric parking brake <sup>3)</sup>					
	1.5 dCi	70		11.10		- electric parking brake <sup>3)</sup>					
	1.5 dCi	78		04.09		- electric parking brake <sup>3)</sup>					
	1.5 dCi	81		04.09		- electric parking brake <sup>3)</sup>					
	1.6 16V	81		04.09		- electric parking brake <sup>3)</sup>					
	1.6 dCi	96		04.11		- electric parking brake <sup>3)</sup>					
	1.6 E85	81		06.09		- electric parking brake <sup>3)</sup>					
	1.9 dCi	96		04.09		- electric parking brake <sup>3)</sup>					
	2.0 16V	103		04.09		- electric parking brake <sup>3)</sup>					
RENAULT GRAND SCENIC (JM_) (04-09)											
	1.5 dCi	74		04.04	09.05			G1020685		23930 18,2 /Acc/S	BOS
	1.6	83		04.04	09.05						
	1.9 dCi	81		05.05	09.05						
	1.9 dCi	88		04.04	09.05						
	1.9 dCi	96		05.05	09.05						
	2.0 16V	99		04.04	09.05						
	2.0 dCi	110		09.05	09.05						
	1.5 dCi	74		10.05	03.09			G1020867		23245 18,3 +	ATE
	1.6	83		10.05	03.09						
	1.9 dCi	81		10.05	03.09						
	1.9 dCi	88		10.05	03.09						
	1.9 dCi	96		10.05	03.09						
	2.0 16V	99		10.05	03.09						
	2.0 dCi	110		10.05	03.09						
	1.5 dCi	74		04.04	03.09			G2124191		300 24,0 21,8 V L +S +C	
	1.6	83		04.04	03.09						
	1.9 dCi	81		05.05	03.09						
	1.9 dCi	88		04.04	03.09						
	1.9 dCi	96		05.05	03.09						
	2.0 16V	99		04.04	03.09						
	1.5 dCi	74		04.04	03.09			G1020489		23554 16,3 /WD/Acc/S	LUC
	1.6	83		04.04	03.09						
	1.9 dCi	81		05.05	03.09						
	1.9 dCi	88		04.04	03.09						
	1.9 dCi	96		05.05	03.09						
	2.0 16V	99		04.04	03.09						
	2.0 16V Turbo	120		04.04	03.09						
RENAULT GRAND SCENIC (JZ_) (09-)											
	1.5 dCi	63		04.09				G1201126		24538 17,9 +	ATE
	1.2 TCe	85		03.12				G1020834		24709 18,6 +	ATE
	1.2 TCe	97		03.13							
	1.4 16V	96		02.09							
	1.5 dCi	70		11.10							
	1.5 dCi	78		02.09							
	1.5 dCi	81		04.09							
	1.6 16V	81		02.09							
	1.6 dCi	96		04.11							
	1.9 dCi	96		02.09							
	2.0 16V	103		02.09							
	1.5 dCi	63		04.09				G2124221		280 24,0 21,8 V L +S +C	
RENAULT THALIA I (LB_) (98-)											
	1.2 16V	55		04.02				G1020501		21463 18,2 /W/S	LUC
	1.4	55		08.00							
	1.4 16V	72		08.00							
	1.5 dCi	47		06.05							
	1.5 dCi	48		04.02							
	1.5 dCi	50		02.03							
	1.5 dCi	60		06.01							
	1.6 16V	79		04.02							

<sup>1)</sup> + ruota 16"/17" / + roue 16"/17" / + ruedas 16"/17" / + 16"/17" Rad

<sup>2)</sup> + ruota 15" / + roue 15" / + rueda 15" / + 15" Rad



















<sup>3)</sup> - freno a mano elettrico / - frein à main électrique / - freno de mano eléctrico / - elektrische Feststellbremse

										
<b>RENAULT THALIA I (LB_) (98-)</b>										
	1.9 D	48		02.98	05.01	G1020501	21463 18,2 /W/S LUC			
	1.2 16V	55		04.02		G2112116	238 12,0 10,5 +S +C			
	1.4	55		08.00						
	1.2 16V	55		04.02						
	1.4 16V	72		08.00						
	1.5 dCi	47		06.05						
	1.5 dCi	48		04.02						
	1.5 dCi	50		02.03						
	1.5 dCi	60		06.01						
1.6 16V	79		04.02		G2120125	238 20,1 17,7 V +S +C				
1.9 D	48		02.98	05.01						
<b>RENAULT THALIA II / SYMBOL (LU_) (08-)</b>										
	1.2 16V	55		09.08		G1020501	21463 18,2 /W/S LUC			
	1.5 dCi	47		09.08						
	1.5 dCi	62		09.08						
	1.6 16V	77		09.08						
	1.2 16V	55		09.08		G2112116	238 12,0 10,5 +S +C			
	1.5 dCi	47		09.08						
	1.5 dCi	62		09.08						
	1.6 16V	77		09.08						
	1.2 16V	55		09.08		G2121106	259 20,6 17,7 V +S +C			
	1.5 dCi	47		09.08						
	1.5 dCi	62		09.08						
	1.6 16V	77		09.08						
<b>RENAULT TRAFIC II (JL/FL/EL) (01-)</b>										
	1.9 dCi	59		04.01	07.03	G1020633	23099 18,4 /S LUC			
	1.9 dCi 100	74		03.01						
	1.9 dCi 80	60		03.01						
	2.0 16V	86		08.06						
	2.0 16V	88		03.01						
	2.0 dCi 115	84		10.06						
	2.0 dCi 90	66		10.06						
	2.5 dCi	84		08.07						
	2.5 dCi 115	84		02.08						
	2.5 dCi 135	99		05.03						
	2.5 dCi 145	107		10.06						
	2.5 DTi	99		03.03	07.03					
	1.9 dCi	59		04.01	07.03			G2128132	305 28,0 24,0 V L +S +C	
	1.9 dCi 100	74		03.01						
	1.9 dCi 80	60		03.01						
	2.0 16V	86		08.06						
	2.0 16V	88		03.01						
	2.0 dCi 115	84		10.06						
	2.0 dCi 90	66		10.06						
	2.5 dCi	84		08.07						
	2.5 dCi 115	84		02.08						
	2.5 dCi 135	99		05.03						
	2.5 dCi 145	107		10.06						
	2.5 DTi	99		03.03	07.03					
		1.9 dCi	59		04.01	07.03	G1020529			23980 16,5 /WD/S LUC
		1.9 dCi 100	74		03.01					
1.9 dCi 80		60		03.01						
2.0 16V		86		08.06						
2.0 16V		88		03.01						
2.0 dCi 115		84		10.06						
2.0 dCi 90		66		10.06						
2.5 dCi		84		08.07						
2.5 dCi 115		84		02.08						
2.5 dCi 135		99		05.03						
2.5 dCi 145		107		10.06						
2.5 DTi		99		03.03	07.03					
<b>RENAULT TWINGO I Saloon (C06_) (93-06)</b>										
		1.2 (C063,C064)	40		03.93	10.96		G1020323	20634 15,0 BDX	
	1.2 (C066,C068)	43		05.96	09.98	G1020219	21097 15,0 +/WI BDX			
	1.2 (C067)	40		05.96	09.98					
	1.2 (C060)	44		08.04	07.07					
	1.2 (C066,C068)	43		10.98	07.07					
	1.2 (C067)	40		10.98	07.07					
	1.2 (C06C,C06D,C06K)	55		01.01	07.07					
	1.2 (C063,C064)	40		03.93	10.96			G2108104	238 8,2 7,0 +S +C	
	1.2 (C066,C068)	43		05.96	09.98					
1.2 (C067)	40		05.96	09.98						
1.2 (C066,C068)	43		10.98	08.00						
1.2 (C067)	40		10.98	07.07						
1.2 (C06C,C06D,C06K)	55		01.01	10.03						
1.2 (C060)	44		08.04	07.07						
1.2 (C066,C068)	43		09.00	10.03						
1.2 (C066,C068)	43		11.03	07.07	G2112171	259 12,0 10,6 +S +C				
1.2 (C06C,C06D,C06K)	55		01.01	10.03						
	1.2 (C066,C068)	43		11.03	07.07	G2112171	259 12,0 10,6 +S +C			
	1.2 (C06C,C06D,C06K)	55		11.03	07.07					

1) + scatola cambio velocità / + transmission mécanique / + cambio de velocidad / + Schaltgetriebe





















2) + sospensione rinforzata / + châssis renforcé / + suspensión reforzada / + verstärktes Fahrwerk

3) - sospensione rinforzata / - châssis renforcé / - suspensión reforzada / - verstärktes Fahrwerk

										
<b>RENAULT TWINGO I Van (S06_) (93-07)</b>										
	1.2 (S063,S064)	40		03.93	04.96		G1020323	20634 15,0	BDX	
	1.2 (S066,S068)	43		05.96	09.98	+ manual transmission <sup>1)</sup>				
	1.2 (S066,S068)	43		10.98	07.07	+ manual transmission <sup>1)</sup>	G1020501	21463 18,2 /W/S	LUC	
	1.2 (S066,S068)	43		10.98	07.07	+ autom.transmission <sup>2)</sup>				
	1.2 (S063,S064)	40		03.93	04.96		G2108104	238 8,2 7,0 +S +C		
	1.2 (S066,S068)	43		05.96	09.98	+ manual transmission <sup>1)</sup>				
	1.2 (S066,S068)	43		10.98	08.00	+ manual transmission <sup>1)</sup>	G2112116	238 12,0 10,5 +S +C		
	1.2 (S066,S068)	43		10.98	08.00	+ autom.transmission <sup>2)</sup>				
	1.2 (S066,S068)	43		09.00	10.03	+ manual transmission <sup>1)</sup>	G2121106	259 20,6 17,7 V +S +C		
1.2 (S066,S068)	43		09.00	10.03	+ autom.transmission <sup>2)</sup>					
1.2 (S066,S068)	43		11.03	07.07		G2112171	259 12,0 10,6 +S +C			
<b>RENAULT TWINGO II (CNO_) (07-)</b>										
	1.2	43		03.07			G1020501	21463 18,2 /W/S	LUC	
	1.2 16V	55		03.07						
	1.2 16V	56		03.07						
	1.2 TCe 100	75		02.11						
	1.2 Turbo	74		03.07						
	1.5 dCi	47		03.07						
	1.5 dCi	62		04.08						
	1.5 dCi 75	55		10.10						
	1.5 dCi 90	63		10.10						
	1.2	43		03.07			G2112171	259 12,0 10,6 +S +C		
	1.5 dCi	47		03.07						
	1.2	43		03.07			G2121106	259 20,6 17,7 V +S +C		
	1.2 16V	55		03.07						
	1.2 16V	56		03.07						
	1.2 TCe 100	75		02.11						
	1.2 Turbo	74		03.07						
	1.5 dCi	47		03.07						
	1.5 dCi	62		04.08						
	1.5 dCi 75	55		10.10						
	1.5 dCi 90	63		10.10						
	1.6 RS	98		05.08			G2124158	280 24,0 21,8 V L +S +C		
	<b>RENAULT VEL SATIS (BJO_) (02-09)</b>									
		2.0	108		04.05	12.09		G1020548	23248 18,3 +	ATE
		2.0 16V Turbo	120		06.02	12.09				
2.0 16V Turbo		125		04.04	12.09					
2.0 dCi		110		08.05	12.09					
2.0 dCi		127		01.06	12.09					
2.2 dCi		85		04.04	12.09					
2.2 dCi		110		06.02	12.09					
3.0 dCi		130		06.02	12.09					
3.0 dCi		133		06.06	12.09					
3.5		170		10.04	12.09					
3.5 V6		177		06.02	12.09					
	2.0	108		04.05	12.09		G1020470	23482 15,8 +/WD	ATE	
	2.0 16V Turbo	120		06.02	12.09					
	2.0 16V Turbo	125		04.04	12.09					
	2.0 dCi	110		08.05	12.09					
	2.0 dCi	127		01.06	12.09					
	2.2 dCi	85		04.04	12.09					
	2.2 dCi	110		06.02	12.09					
	3.0 dCi	130		06.02	12.09					
	3.0 dCi	133		06.06	12.09					
	3.5	170		10.04	12.09					
	3.5 V6	177		06.02	12.09					
<b>RENAULT WIND (E4M_) (10-13)</b>										
	1.2 16V Turbo	74		07.10	09.13		G2124158	280 24,0 21,8 V L +S +C		
	1.2 TCe 100	75		02.11	09.13					
	1.6 16V	98		07.10	09.13					
<b>RENAULT ZOE (12-)</b>										
	Z.E.	65		06.12			G2122270	258 22,0 19,8 V L +S +C		
<b>ROLLS ROYCE SILVER SERAPH</b>										
	5.4			03.98	12.02		G1020683	21484 20,5 +/WD	ATE	
<b>ROVER 25 series (RF) (99-05)</b>										
	1.1 16V	55		01.04	05.05		G2121105	262 21,0 19,0 V +S +C		
	1.4 16V	62		10.99	05.05					
	1.4 16V	76		10.99	05.05					
	1.6 16V	80		10.99	05.05					
	1.8 16V	85		10.99	05.05					
	1.8 16V	107		02.00	05.05					
	2.0 IDT	74		10.99	05.05					

<sup>1)</sup> + scatola cambio velocità / + transmission mécanique / + cambio de velocidad / + Schaltgetriebe

<sup>2)</sup> + scatola cambio automatico / + transmission automatique / + cambio automático / + Automatikgetriebe

								
<b>ROVER 25 series (RF) (99-05)</b>								
	1.1 16V 1.4 16V 1.4 16V 1.6 16V 1.8 16V 1.8 16V 2.0 iDT	55 62 76 80 85 107 74		01.04 05.05 10.99 05.05 10.99 05.05 10.99 05.05 10.99 05.05 02.00 05.05 10.99 05.05		G2110212		239 10,0 8,0 +S +C
<b>ROVER 45 series (RT) (00-05)</b>								
	1.4 1.6 1.8 2.0 iDT 2.0 V6	76 80 86 74 110		02.00 05.05 02.00 05.05 02.00 05.05 02.00 05.05 02.00 05.05		G2121105		262 21,0 19,0 V +S +C
	1.4 1.6 1.8 2.0 iDT 2.0 V6	76 80 86 74 110		02.00 05.05 02.00 05.05 02.00 05.05 02.00 05.05 02.00 05.05		G2110212		239 10,0 8,0 +S +C
<b>ROVER 75 series (RJ) (99-04)</b>								
	1.8 1.8 Turbo 2.0 CDT 2.0 CDTi 2.0 V6 2.5 V6 2.5 V6	88 110 85 96 110 129 130		02.99 05.04 05.03 05.04 02.99 05.04 02.03 05.04 02.99 05.04 02.99 10.01 08.01 05.04		G1020316		20180 17,1 +/WD ATE
<b>ROVER 75 series (RX) (04-05)</b>								
	1.8 1.8 Turbo 2.0 CDTi 2.5 V6 4.6 V8	88 110 96 130 191		04.04 05.05 + brake disc 325 X 25 <sup>1)</sup> 04.04 05.05 + brake disc 325 X 25 <sup>1)</sup> 04.04 05.05 + brake disc 325 X 25 <sup>1)</sup> 04.04 05.05 + brake disc 325 X 25 <sup>1)</sup> 04.04 05.05 + brake disc 325 X 25 <sup>1)</sup>		G1020591 G1020591		23183 20,3 +/WD ATE 23183 20,3 +/WD ATE
	1.8 1.8 Turbo 2.0 CDTi 2.5 V6	88 110 96 130		04.04 05.05 04.04 05.05 04.04 05.05 04.04 05.05		G1020316		20180 17,1 +/WD ATE
<b>ROVER 200 series (XW) (90-95)</b>								
	214 214 16V 216 16V 218 TD 220 16V			01.90 10.95 + ABS 01.90 10.95 + ABS 01.90 10.95 + ABS 01.91 10.95 + ABS 01.91 10.95		G2110212		239 10,0 8,0 +S +C
<b>ROVER 200 series II (RF) (95-00)</b>								
	211 214 i 214 Si 216 Si 218 i 16V Vitesse 220 D 220 SDi	44		01.98 03.00 01.96 03.00 11.95 03.00 11.95 03.00 01.96 03.00 01.96 03.00 01.96 03.00 + ABS		G2121105		262 21,0 19,0 V +S +C
	211 214 i 214 Si 216 Si 218 i 16V Vitesse 220 D 220 SDi	44		01.98 03.00 + ABS 01.96 03.00 + ABS 11.95 03.00 + ABS 01.96 03.00 + ABS 01.97 03.00 + ABS 01.96 03.00 + ABS 01.96 03.00 + ABS		G2110212		239 10,0 8,0 +S +C
<b>ROVER 400 series (XW) (90-95)</b>								
	414 414 16V 416 16V 418 TD 420 16V 420 Turbo			01.90 04.95 + ABS 01.90 04.95 + ABS 01.90 04.95 + ABS 01.91 04.95 + ABS 01.91 04.95 01.93 04.95		G2110212		239 10,0 8,0 +S +C
<b>ROVER 400 series (RT) (95-00)</b>								
	414 Si 416 Si 420 D 420 Di 420 Si	76 63 77 100		06.95 03.00 + ABS 06.95 03.00 11.95 03.00 05.95 03.00 06.95 03.00		G2121105		262 21,0 19,0 V +S +C
	414 Si 416 Si 420 D 420 Di 420 Si	76 63 77 100		06.95 03.00 06.95 03.00 11.95 03.00 05.95 03.00 12.95 03.00		G2110212		239 10,0 8,0 +S +C

<sup>1)</sup> + dischi freno 325 X 25 / + disque de frein 325 X 25 / + disco de freno 325 X 25 / + Bremsscheibe 325 X 25



SAAB 9-3 (YS3D) (98-02)										
	2.0 i	96		02.98	09.02	G1020642			23116 19,8 +/Wl	ATE
	2.0 SE Turbo	147		02.98	09.02					
	2.0 Turbo	110		01.01	09.02					
	2.0 Turbo	113		10.98	09.02					
	2.0 Turbo	136		02.98	09.02					
	2.0 Turbo	151		10.99	09.02					
	2.2 TiD	85		02.98	11.00					
	2.2 TiD	92		11.00	09.02					
	2.3 i	110		02.98	09.02					
2.3 Turbo	165		10.98	09.02						
	2.0 i	96		02.98	09.02	G2125119			288 25,0 22,0 V L + S + C	
	2.0 SE Turbo	147		02.98	09.02					
	2.0 Turbo	110		01.01	09.02					
	2.0 Turbo	113		10.98	09.02					
	2.0 Turbo	136		02.98	09.02					
	2.0 Turbo	151		10.99	09.02					
	2.2 TiD	85		02.98	11.00					
	2.2 TiD	92		11.00	09.02					
	2.3 i	110		02.98	09.02					
	2.0 i	96		02.98	09.02	G1020271			21050 15,0	ATE
	2.0 SE Turbo	147		02.98	09.02					
	2.0 Turbo	110		01.01	09.02					
	2.0 Turbo	113		10.98	09.02					
	2.0 Turbo	136		02.98	09.02					
	2.0 Turbo	151		10.99	09.02					
	2.2 TiD	85		02.98	11.00					
	2.2 TiD	92		11.00	09.02					
	2.3 i	110		02.98	09.02					
2.3 Turbo	165		10.98	09.02						

SAAB 9-3 Saloon (YS3F) (03-12)										
	1.8 i	90		03.04	12.05 + 16" wheel/ - Vector 1)	G1020836 G1020650	for br.caliper + steel piston 2) for br.caliper + plastic piston 3)		23738 20,1 +/WD 23402 20,1 +/WD	ATE ATE
	1.8 i	90		03.04	12.05 + 15" wheel 4)					
	1.8 t	110		09.02	12.05 + 16" wheel/ - Vector 1)					
	1.8 t	110		09.02	12.05 + 15" wheel 4)					
	1.9 TiD	88		07.04	12.05 + 16" wheel/ - Vector 1)					
	1.9 TiD	88		07.04	12.05 + 15" wheel 4)					
	1.9 TiD	110		07.04	12.05 + 16" wheel/ - Vector 1)					
	1.9 TiD	110		07.04	12.05 + 15" wheel 4)					
	2.0 t			09.02	12.05 + 16" wheel/ - Vector 1)					
	2.0 t			09.02	12.05 + 15" wheel 4)					
	2.0 Turbo Performance			04.04	12.05 + 15" wheel 4)					
	2.2 TiD	92		09.02	12.05 + 16" wheel/ - Vector 1)					
	2.2 TiD	92		09.02	12.05 + 15" wheel 4)					
	1.8 i	90		01.06	12.08 - Vector	G1020756 G1020836 G1020650	+ 16" wheel, - USA 5) + 16" wheel/ + USA/ + steel piston 6) + 16" wheel/ + USA/ + plastic piston 7)		23404 20,6 +/WD 23738 20,1 +/WD 23402 20,1 +/WD	ATE ATE ATE
	1.8 i Vector	90		09.02	12.08					
	1.8 t BioPower	110		01.07	12.08					
	1.9 TiD	88		01.06	12.08 - Vector					
	1.9 TiD	110		01.06	12.08 - Vector					
	1.9 TiD Vector	88		07.04	12.08					
	1.9 TiD Vector	110		07.04	12.08					
	1.9 TTiD			07.07	12.08					
	1.9 TTiD			07.07	12.08 - Vector					
	2.0 t			01.06	12.08 - Vector					
	2.0 T Aero	154		09.02	12.08					
	2.0 t BioPower			01.07	12.08					
	2.0 t BioPower	145		06.07	12.08					
	2.0 t BioPower XWD			09.02	12.08					
	2.0 t Vector	129		09.02	12.08					
	2.0 t XWD			01.07	12.08					
	2.0 Turbo Performance			04.04	12.08					
	2.2 TiD	92		01.06	12.08 - Vector					
	2.2 TiD Vector	92		09.02	12.08					
2.8 T Aero	184		03.05	12.08						
2.8 T Aero	188		07.07	12.08						
2.8 T Aero	206		07.07	12.08						
2.8 T Aero V6 XWD	206		04.08	12.08						
2.8 Turbo V6			04.08	12.08						
	1.8 i	90		01.09	06.12 - Vector	G1020772	+ 17" wheel 8)		23912 18,6 +	ATE
	1.8 i Vector	90		01.09	06.12					
	1.8 t BioPower	110		01.09	06.12					
	1.9 TiD	88		01.09	06.12 - Vector					
	1.9 TiD	110		01.09	06.12 - Vector					
	1.9 TiD Vector	88		01.09	06.12					
	1.9 TiD Vector	110		01.09	06.12					
	1.9 TTiD			01.09	06.12					
	1.9 TTiD			01.09	06.12 - Vector					
	2.0 t			01.09	06.12 - Vector					
	2.0 T Aero	154		01.09	06.12					
	2.0 t BioPower			01.09	06.12					
	2.0 t BioPower	145		01.09	06.12					
	2.0 t BioPower XWD			01.09	06.12					
	2.0 t Vector	129		01.09	06.12					
	2.0 t XWD			01.09	06.12					
	2.0 Turbo Performance			01.09	06.12					
	2.2 TiD	92		01.09	06.12 - Vector					
	2.2 TiD Vector	92		01.09	06.12					

1) + ruota 16"/ - Vector / + roue 16"/ - Vector / + rueda 16"/ - Vector / + 16" Rad/ - Vector  
2) per pinza fr. + pistone acciaio / pour étrier fr. + piston en acier / para pinza fr. + pistón de acero / f. Bremssattel m. Stahlkolben  
3) per pinza fr. + pistone plastica / pour étrier fr. + piston plastique / para pinza fr. + pistón plástico / f. Bremssattel m. Kunststoffkolben  
4) + ruota 15" / + roue 15" / + rueda 15" / + 15" Rad  
5) + ruota 16" - USA / + roue 16" - USA / + rueda 16" - USA / + 16" Rad/ - USA  
6) + ruota 16" / + USA/ + pistone acciaio / + roue 16" / + USA/ + piston acier / + rueda 16" / + USA/ + pistón acero / + 16" Rad/ + USA/ + Stahlkolben  
7) + ruota 16" / + USA/ + pistone plastica / + roue 16" / + USA/ + piston plastique / + rueda 16" / + USA/ + pistón plástico / + 16" Rad/ + USA/ + Kunststoffkolben  
8) + ruota 17" / + roue 17" / + rueda 17" / + 17" Rad





SAAB 9-3 Saloon (YS3F) (03-12)									
	2.8 T Aero 2.8 T Aero 2.8 T Aero 2.8 T Aero V6 XWD 2.8 Turbo V6	184 188 206 206		01.09 01.09 01.09 01.09	06.12 06.12 06.12 06.12	G1020772	+ 17" wheel <sup>1)</sup>	23912 18,6 +	ATE
	1.8 i 1.8 t 1.8 t BioPower 1.9 TiD 1.9 TiD 1.9 TTiD 2.0 t Arc/Linear 2.0 t BioPower 2.0 t BioPower 2.0 Turbo Performance 2.2 TiD	90 110 110 88 110 129 145 92		03.04 09.02 01.07 07.04 07.04 07.07 09.02 01.07 06.07 04.04 09.02	06.12 06.12 06.12 06.12 06.12 06.12 06.12 06.12 06.12 06.12 06.12	G2125141	+ 15" wheel <sup>2)</sup>	285 24,9 22,0 V L +S +C	
	2.0 T Aero 2.0 T Aero 2.0 t BioPower XWD 2.0 t Vector 2.0 t XWD 2.0 Turbo Performance 2.8 T Aero 2.8 T Aero 2.8 T Aero 2.8 T Aero 2.8 T Aero V6 XWD 2.8 Turbo V6	154 154 129 184 184 188 206 206		01.06 09.02 09.02 01.07 04.04 01.06 03.05 07.07 07.07 04.08	06.12 + (USA) 06.12 - (USA) 06.12 06.12 06.12 06.12 06.12 + (USA) 06.12 - (USA) 06.12 06.12	G2128164	+ 16" wheel <sup>3)</sup>	314 28,0 25,0 V L +S +C	
	1.8 i 1.8 t 1.8 t BioPower 1.9 TiD 1.9 TiD 1.9 TTiD 2.0 t 2.0 T Aero 2.0 t BioPower 2.0 t BioPower 2.0 t BioPower XWD 2.0 t XWD 2.0 Turbo Performance 2.2 TiD 2.8 T Aero 2.8 T Aero 2.8 T Aero 2.8 T Aero V6 XWD 2.8 Turbo V6	90 110 110 88 110 154 145 92 184 188 206 206	76001222 76001222 76001222 76001222 76001222 76001222 76001222 76001222 76001222 76001222 76001222 76001222 76001222 76001222 76001222 76001222 76001222	03.04 09.02 01.07 07.04 07.04 07.07 09.02 09.02 01.07 06.07 09.02 01.07 04.04 09.02 03.05 07.07 07.07 04.08		G1020670		23482 16,6 +	ATE
	1.8 i 1.8 t 1.8 t BioPower 1.9 TiD 1.9 TiD 1.9 TTiD 2.0 t 2.0 T Aero 2.0 t BioPower 2.0 t BioPower 2.0 t BioPower XWD 2.0 t XWD 2.0 Turbo Performance 2.2 TiD 2.8 T Aero 2.8 T Aero 2.8 T Aero 2.8 T Aero V6 XWD 2.8 Turbo V6	90 110 110 88 110 154 145 92 184 188 206 206	76001223 76001223 76001223 76001223 76001223 76001223 76001223 76001223 76001223 76001223 76001223 76001223 76001223 76001223 76001223 76001223 76001223	06.12 06.12 06.12 06.12 06.12 06.12 06.12 06.12 06.12 06.12 06.12 06.12 06.12 06.12 06.12 06.12 06.12		G1020727		23482 16,6 +	ATE
	1.8 i 1.8 t 1.8 t BioPower 1.9 TiD 1.9 TiD 1.9 TTiD 2.0 t 2.0 T Aero 2.0 t BioPower 2.0 t BioPower 2.0 Turbo Performance 2.2 TiD 2.8 T Aero 2.8 T Aero 2.8 T Aero 2.8 Turbo V6	90 110 110 88 110 154 145 92 184 188 206 206		03.04 09.02 01.07 07.04 07.04 07.07 09.02 09.02 01.07 06.07 04.04 09.02 03.05 07.07 07.07 04.08	06.12 06.12 06.12 06.12 06.12 06.12 06.12 06.12 06.12 06.12 06.12 06.12 06.12 06.12 06.12 06.12	G2112157	+ 15" wheel <sup>2)</sup>	278 11,9 10,0 +S +C	

1) + ruota 17" / + roue 17" / + rueda 17" / + 17" Rad  
 2) + ruota 15" / + roue 15" / + rueda 15" / + 15" Rad  
 3) + ruota 16" / + roue 16" / + rueda 16" / + 16" Rad







**SAAB 9-3 Sport Estate (05-12)**

	1.8 i	90		03.05	06.12	G1020836 G1020650	+ 15"/16" wheel/+ steel piston <sup>1)</sup> + 15"/16" wheel/+ plastic piston <sup>2)</sup>	23738 20,1 +/WD 23402 20,1 +/WD	ATE ATE					
	1.8 t	110		03.05	06.12									
	1.8 t BioPower	110		01.07	06.12									
	1.8 t BioPower	129		07.07	06.12									
	1.9 TiD	88		03.05	06.12									
	1.9 TiD	110		03.05	06.12									
	1.9 TTiD			07.07	06.12									
	2.0	143		04.06	09.07									
	2.0 t			03.05	06.12									
	2.0 t BioPower			01.07	06.12									
	2.0 t BioPower	145		06.07	06.12									
	2.0 t BioPower	147		07.07	06.12									
	2.0 t BioPower	162		01.11	06.12									
	2.0 t BioPower XWD			01.07	06.12									
	2.0 t BioPower XWD	162		01.11	06.12									
2.0 t XWD			01.07	06.12										
	2.0 T			03.05	12.08	G1020756	+ 16" plus wheel <sup>3)</sup>	23404 20,6 +/WD	ATE					
	2.0 T XWD	154		07.08	12.08									
	2.8 T	184		03.05	12.08									
	2.8 T	188		07.07	12.08									
	2.8 T Aero	206		07.07	12.08									
	2.8 T Aero V6 XWD	206		04.08	12.08									
	2.8 Turbo V6	169		03.05	12.08									
	2.8 Turbo V6	203		05.08	12.08									
		2.0 T			01.09					06.12	G1020772	+ 17" wheel <sup>4)</sup>	23912 18,6 +	ATE
		2.0 T XWD	154		01.09					06.12				
2.0 T XWD		177		03.09	06.12									
2.8 T		184		01.09	06.12									
2.8 T		188		01.09	06.12									
2.8 T Aero		206		01.09	06.12									
2.8 T Aero V6 XWD		206		01.09	06.12									
2.8 Turbo V6		169		01.09	06.12									
2.8 Turbo V6		203		01.09	06.12									
		2.0 T			01.06	06.12	G2128164	+ 16" wheel <sup>5)</sup>	314 28,0 25,0 V L +S +C					
	2.0 T			03.05	06.12									
	2.0 T XWD	154		07.08	06.12									
	2.0 T XWD	177		03.09	06.12									
	2.8 T	184		03.05	06.12									
	2.8 T	188		07.07	06.12									
	2.8 T Aero	206		07.07	06.12									
	2.8 T Aero V6 XWD	206		04.08	06.12									
	2.8 Turbo V6	169		03.05	06.12									
	2.8 Turbo V6	203		05.08	06.12									
	1.8 i	90	76001222	03.05	06.12	G1020670		23482 16,6 +	ATE					
	1.8 t	110	76001222	03.05	06.12									
	1.8 t BioPower	110	76001222	01.07	06.12									
	1.8 t BioPower	129	76001222	07.07	06.12									
	1.9 TiD	88	76001222	03.05	06.12									
	1.9 TiD	110	76001222	03.05	06.12									
	1.9 TTiD		76001222	07.07	06.12									
	2.0	143	76001222	04.06	06.12									
	2.0 T		76001222	03.05	06.12									
	2.0 t		76001222	03.05	06.12									
	2.0 t BioPower		76001222	01.07	06.12									
	2.0 t BioPower	145	76001222	06.07	06.12									
	2.0 t BioPower	147	76001222	07.07	06.12									
	2.0 t BioPower	162	76001222	01.11	06.12									
	2.0 t BioPower XWD		76001222	01.07	06.12									
	2.0 t BioPower XWD	162	76001222	01.11	06.12									
	2.0 t XWD		76001222	01.07	06.12									
	2.0 T XWD	154	76001222	07.08	06.12									
	2.0 T XWD	177	76001222	03.09	06.12									
	2.8 T	184	76001222	03.05	06.12									
	2.8 T	188	76001222	07.07	06.12									
	2.8 T Aero	206	76001222	07.07	06.12									
2.8 T Aero V6 XWD	206	76001222	04.08	06.12										
2.8 Turbo V6	169	76001222	03.05	06.12										
2.8 Turbo V6	203	76001222	05.08	06.12										
	1.8 i	90	76001223		06.12	G1020727		23482 16,6 +	ATE					
	1.8 t	110	76001223		06.12									
	1.8 t BioPower	110	76001223		06.12									
	1.8 t BioPower	129	76001223		06.12									
	1.9 TiD	88	76001223		06.12									
	1.9 TiD	110	76001223		06.12									
	1.9 TTiD		76001223		06.12									
	2.0 T		76001223		06.12									
	2.0 t		76001223		06.12									
	2.0 t BioPower		76001223		06.12									
	2.0 t BioPower	145	76001223		06.12									
	2.0 t BioPower	147	76001223		06.12									
	2.0 t BioPower	162	76001223		06.12									
	2.0 t BioPower XWD		76001223		06.12									
	2.0 t BioPower XWD	162	76001223		06.12									
2.0 t XWD		76001223		06.12										
2.0 T XWD	154	76001223		06.12										
2.0 T XWD	177	76001223		06.12										
2.8 T	184	76001223		06.12										

1) + ruota 15"/16" /+ pistone acciaio / + roue 15"/16" /+ piston acier / + rueda 15"/16" /+ pistón acero / + 15"/16" Rad/+ Stahlkolben  
2) + ruota 15"/16" /+ pistone plastica / + roue 15"/16" /+ piston plastique / + rueda 15"/16" /+ pistón plástico / + 15"/16" Rad/+ Kunststoffkolben  
3) + ruota 16" plus / + roue 16" plus / + rueda 16" plus / + 16" plus Rad  
4) + ruota 17" / + roue 17" / + rueda 17" / + 17" Rad  
5) + ruota 16" / + roue 16" / + rueda 16" / + 16" Rad

SAAB 9-3 Sport Estate (05-12)		SAAB 9-3 Convertible (YS3D) (98-03)		SAAB 9-3 Convertible (YS3F) (03-12)				
	2.8 T 2.8 T Aero 2.8 T Aero V6 XWD 2.8 Turbo V6 2.8 Turbo V6	188 76001223 206 76001223 206 76001223 169 76001223 203 76001223		06.12 06.12 06.12 06.12 06.12	G1020727		23482 16,6 +	ATE
	1.8 i 1.8 t 1.9 TiD 1.9 TiD 2.0 t	90 110 88 110		03.05 08.05 03.05 08.05 03.05 08.05 03.05 08.05	G2112157		278 11,9 10,0 +S +C	
	1.8 i 1.8 t 1.8 t BioPower 1.8 t BioPower 1.9 TiD 1.9 TiD 1.9 TTiD 2.0 2.0 T 2.0 t 2.0 t BioPower 2.0 t BioPower 2.0 t BioPower 2.0 t BioPower 2.0 t BioPower XWD 2.0 t BioPower XWD 2.0 t XWD 2.0 T XWD 2.0 T XWD 2.8 T 2.8 T 2.8 T Aero 2.8 T Aero V6 XWD 2.8 Turbo V6 2.8 Turbo V6	90 110 110 129 88 110 143 145 147 162 162 154 177 184 188 206 206 169 203		09.05 06.12 09.05 06.12 01.07 06.12 07.07 06.12 09.05 06.12 09.05 06.12 07.07 06.12 04.06 09.07 09.05 06.12 09.05 06.12 01.07 06.12 06.07 06.12 07.07 06.12 01.11 06.11 01.07 06.12 01.11 06.12 01.07 06.12 07.08 06.12 03.09 06.12 09.05 06.12 07.07 06.12 07.07 06.12 04.08 06.12 03.05 06.12 05.08 06.12	G2112157	+ 15" wheel <sup>1)</sup>	278 11,9 10,0 +S +C	
	2.0 i 2.0 SE Turbo 2.0 T 2.0 T 2.0 T 2.0 Turbo 2.3 i 2.3 i	96 147 113 136 151 110 110 165		02.98 08.02 02.98 08.02 10.98 08.02 02.98 08.02 10.99 08.02 01.01 08.02 02.98 08.02 10.99 08.02	G1020642		23116 19,8 +/Wl	ATE
	2.0 i 2.0 SE Turbo 2.0 T 2.0 T 2.0 T 2.0 Turbo 2.3 i 2.3 i	96 147 113 136 151 110 110 165		09.02 07.03 09.02 07.03 09.02 07.03 09.02 07.03 09.02 07.03 09.02 07.03 09.02 07.03 09.02 07.03	G1020836 G1020650	for br.caliper +steel piston <sup>2)</sup> for br.caliper +plastic piston <sup>3)</sup>	23738 20,1 +/WD 23402 20,1 +/WD	ATE ATE
	2.0 i 2.0 SE Turbo 2.0 T 2.0 T 2.0 T 2.0 Turbo 2.3 i	96 147 113 136 151 110 110		02.98 07.03 02.98 07.03 10.98 07.03 02.98 07.03 10.99 07.03 01.01 07.03 02.98 07.03	G2125119		288 25,0 22,0 V L +S +C	
	2.0 i 2.0 SE Turbo 2.0 T 2.0 T 2.0 T 2.0 Turbo 2.3 i 2.3 i	96 147 113 136 151 110 110 165		02.98 08.02 02.98 08.02 10.98 08.02 02.98 08.02 10.99 08.02 01.01 08.02 02.98 08.02 10.99 08.02	G1020271		21050 15,0	ATE
	2.0 i 2.0 SE Turbo 2.0 T 2.0 T 2.0 T 2.0 Turbo 2.3 i 2.3 i	96 147 113 136 151 110 110 165		09.02 07.03 09.02 07.03 09.02 07.03 09.02 07.03 09.02 07.03 09.02 07.03 09.02 07.03 09.02 07.03	G1020670		23482 16,6 +	ATE
	1.8 t 1.8 t BioPower 1.8 t BioPower 1.9 TiD 1.9 TTiD 2.0 2.0 t 2.0 T 2.0 t BioPower	110 110 129 110 143		08.03 06.12 01.07 06.12 07.07 06.12 01.06 06.12 07.07 06.12 04.06 09.07 08.03 06.12 08.03 06.12 06.07 06.12	G1020836 G1020650	+ 15"/16" wheel/+ steel piston <sup>4)</sup> + 15"/16" wheel/+ plastic piston <sup>5)</sup>	23738 20,1 +/WD 23402 20,1 +/WD	ATE ATE

<sup>1)</sup> + ruota 15" / + roue 15" / + rueda 15" / + 15" Rad

<sup>2)</sup> per pinza fr. +pistone acciaio / pour étrier f. +piston en acier / para pinza fr. +piston de acero / f. Bremssattel m.Stahlkolben

<sup>3)</sup> per pinza fr. +pistone plastica / pour étrier f. +piston plastique / para pinza fr. + piston plástico / f. Bremssattel m.Kunststoffkolben

<sup>4)</sup> + ruota 15"/16" / + pistone acciaio / + roue 15"/16" / + piston acier / + rueda 15"/16" / + piston acero / + 15"/16" Rad/+ Stahlkolben















<sup>5)</sup> + ruota 15"/16" / + pistone plastica / + roue 15"/16" / + piston plastique / + rueda 15"/16" / + piston plástico / + 15"/16" Rad/+ Kunststoffkolben



**SAAB 9-3 Convertible (YS3F) (03-12)**

	2.0 t BioPower	147		01.07	06.12	G1020836 G1020650	+ 15"/16" wheel/+ steel piston <sup>1)</sup> + 15"/16" wheel/+ plastic piston <sup>2)</sup>	23738 20,1 +/WD 23402 20,1 +/WD	ATE ATE					
	2.0 t BioPower			07.07	06.12									
	2.0 Turbo Performance	185		04.04	06.12	G1020836 G1020650	+ 16" wheel/+ steel piston <sup>3)</sup> + 16" wheel/+ plastic piston <sup>4)</sup>	23738 20,1 +/WD 23402 20,1 +/WD	ATE ATE					
	2.0 T			08.03	06.12					+ USA				
	2.0 Turbo Performance	185		04.04	06.12					+ USA				
	2.0 T			08.03	12.08					- USA				
	2.0 Turbo Performance	185		04.04	12.08					- USA				
	2.8 T	184		02.06	12.08									
	2.8 T	221		10.08	12.08									
	2.8 T Aero	188		07.07	12.08									
	2.8 T V6 Aero			06.08	12.08									
	2.0 T			01.09	06.12					- USA				
	2.0 Turbo Performance	185		01.09	06.12					- USA				
	2.8 T	184		01.09	06.12									
2.8 T	221		01.09	06.12										
2.8 T Aero	188		01.09	06.12										
2.8 T V6 Aero			01.09	06.12										
	1.8 t	110		08.03	06.12	G2125141	+ 15" wheel <sup>7)</sup>	285 24,9 22,0 V L +S +C						
	1.8 t BioPower	110		01.07	06.12									
	1.8 t BioPower	129		07.07	06.12									
	1.9 TiD	110		01.06	06.12									
	1.9 TTiD			07.07	06.12									
	2.0	143		04.06	09.07									
	2.0 t			08.03	06.12									
	2.0 T			08.03	06.12									
	2.0 t BioPower			06.07	06.12									
	2.0 t BioPower			01.07	06.12									
	2.0 t BioPower	147		07.07	06.12									
	2.0 t Linear	129		08.03	06.12									
	2.0 t Vector	129		08.03	06.12									
	2.0 Turbo Performance	185		04.04	06.12									
	2.0 T			08.03	06.12	G2128164	+ 16" plus wheel <sup>8)</sup>	314 28,0 25,0 V L +S +C						
	2.0 t Vector	129		08.03	06.12									
	2.0 Turbo Performance	185		04.04	06.12									
	2.8 T	184		02.06	06.12									
	2.8 T	221		10.08	06.12									
	2.8 T Aero	188		07.07	06.12									
	2.8 T V6 Aero			06.08	06.12									
		1.8 t	110	76001222	08.03						G1020670		23482 16,6 +	ATE
		1.8 t BioPower	110	76001222	01.07									
		1.8 t BioPower	129	76001222	07.07									
		1.9 TiD	110	76001222	01.06									
		1.9 TTiD		76001222	07.07									
		2.0	143	76001222	04.06									
		2.0 t		76001222	08.03									
2.0 T			76001222	08.03										
2.0 t BioPower			76001222	06.07										
2.0 t BioPower			76001222	01.07										
2.0 t BioPower		147	76001222	07.07										
2.0 Turbo Performance		185	76001222	04.04										
2.8 T		184	76001222	02.06										
2.8 T		221	76001222	10.08										
2.8 T Aero	188	76001222	07.07											
2.8 T V6 Aero		76001222	06.08											
	1.8 t	110	76001223		06.12	G1020727		23482 16,6 +	ATE					
	1.8 t BioPower	110	76001223		06.12									
	1.8 t BioPower	129	76001223		06.12									
	1.9 TiD	110	76001223		06.12									
	1.9 TTiD		76001223		06.12									
	2.0	143	76001223		09.07									
	2.0 t		76001223		06.12									
	2.0 T		76001223		06.12									
	2.0 t BioPower		76001223		06.12									
	2.0 t BioPower		76001223		06.12									
	2.0 t BioPower	147	76001223		06.12									
	2.0 Turbo Performance	185	76001223		06.12									
	2.8 T	184	76001223		06.12									
	2.8 T	221	76001223		06.12									
2.8 T Aero	188	76001223		06.12										
2.8 T V6 Aero		76001223		06.12										
	1.8 t	110		08.03	08.05	G2112157		278 11,9 10,0 +S +C						
	2.0 t Linear	129		08.03	08.05									
		1.8 t	110		09.05	06.12	G2112157	+ 15" wheel <sup>7)</sup>	278 11,9 10,0 +S +C					
		1.8 t BioPower	110		01.07	06.12								
		1.8 t BioPower	129		07.07	06.12								
		1.9 TiD	110		01.06	06.12								
		1.9 TTiD			07.07	06.12								
		2.0	143		04.06	09.07								
		2.0 t			09.05	06.12								
		2.0 T			09.05	06.12								
		2.0 t BioPower			06.07	06.12								
		2.0 t BioPower			01.07	06.12								
		2.0 t BioPower	147		07.07	06.12								
		2.0 t Linear	129		09.05	06.12								
2.0 t Vector		129		09.05	06.12									
2.0 Turbo Performance		185		04.04	06.12									

<sup>1)</sup> + ruota 15"/16" /+ pistone acciaio / + roue 15"/16" /+ piston acier / + rueda 15"/16" /+ pistón acero / + 15"/16" Rad/+ Stahlkolben  
<sup>2)</sup> + ruota 15"/16" /+ pistone plastica / + roue 15"/16" /+ piston plastique / + rueda 15"/16" /+ pistón plástico / + 15"/16" Rad/+ Kunststoffkolben  
<sup>3)</sup> + ruota 16" /+ pistone in acciaio / + roue 16" /+ piston en acier / + rueda 16" /+ pistón de acero / + 16" Rad/+ Stahlkolben  
<sup>4)</sup> + ruota 16" /+ pistone plastica / + roue 16" /+ piston plastique / + rueda 16" /+ pistón plástico / + 16" Rad/+ Kunststoffkolben  
<sup>5)</sup> + ruota 16"/16plus" /+ roue 16"/16plus" /+ rueda 16"/16plus" /+ 16"/16plus" Rad  
<sup>6)</sup> + ruota 17" /+ roue 17" /+ rueda 17" /+ 17" Rad  
<sup>7)</sup> + ruota 15" /+ roue 15" /+ rueda 15" /+ 15" Rad  
<sup>8)</sup> + ruota 16" plus /+ roue 16" plus /+ rueda 16" plus /+ 16" plus Rad

									
<b>SAAB 9-3 Convertible (YS3F) (03-12)</b>									
	2.8 T 2.8 T 2.8 T Aero 2.8 T V6 Aero	184 221 188		02.06 10.08 07.07 06.08	06.12 06.12 06.12 06.12	G2112157	+ 15" wheel <sup>1)</sup>	278 11,9 10,0 +S +C	
<b>SAAB 9-3 X (09-12)</b>									
	1.9 TTiD 1.9 TTiD 2.0 T BioPower XWD 2.0 T BioPower XWD 2.0 T BioPower XWD 2.0 T XWD	96 132 120 154 162 154		01.10 03.09 01.11 03.09 01.11 03.09	06.12 06.12 06.12 06.12 06.12 06.12	G1020836 G1020650	+ 15"/16" wheel/+ steel piston <sup>2)</sup> + 15"/16" wheel/+ plastic piston <sup>3)</sup>	23738 20,1 +/WD 23402 20,1 +/WD	ATE ATE
	1.9 TTiD 1.9 TTiD 2.0 T BioPower XWD 2.0 T BioPower XWD 2.0 T BioPower XWD 2.0 T XWD	96 132 120 154 162 154		01.10 03.09 01.11 03.09 01.11 03.09	06.12 06.12 06.12 06.12 06.12 06.12	G1020756	+ 16" plus wheel <sup>4)</sup>	23404 20,6 +/WD	ATE
	1.9 TTiD 1.9 TTiD 2.0 T BioPower XWD 2.0 T BioPower XWD 2.0 T BioPower XWD 2.0 T XWD	96 132 120 154 162 154		01.10 03.09 01.11 03.09 01.11 03.09	06.12 06.12 06.12 06.12 06.12 06.12	G1020772	+ 17" wheel <sup>5)</sup>	23912 18,6 +	ATE
	1.9 TTiD 1.9 TTiD 2.0 T BioPower XWD 2.0 T BioPower XWD 2.0 T BioPower XWD 2.0 T XWD	96 132 120 154 162 154		01.10 03.09 01.11 03.09 01.11 03.09	06.12 06.12 06.12 06.12 06.12 06.12	G2125141	+ 15" wheel <sup>1)</sup>	285 24,9 22,0 V L +S +C	
	1.9 TTiD 1.9 TTiD 2.0 T BioPower XWD 2.0 T BioPower XWD 2.0 T BioPower XWD 2.0 T XWD	96 132 120 154 162 154		01.10 03.09 01.11 03.09 01.11 03.09	06.12 06.12 06.12 06.12 06.12 06.12	G2128164	+ 16" plus wheel <sup>4)</sup>	314 28,0 25,0 V L +S +C	
	1.9 TTiD 1.9 TTiD 2.0 T BioPower XWD 2.0 T BioPower XWD 2.0 T BioPower XWD 2.0 T XWD	96 132 120 154 162 154		01.10 03.09 01.11 03.09 01.11 03.09	06.12 06.12 06.12 06.12 06.12 06.12	G1020727		23482 16,6 +	ATE
	1.9 TTiD 1.9 TTiD 2.0 T BioPower XWD 2.0 T BioPower XWD 2.0 T BioPower XWD 2.0 T XWD	96 132 120 154 162 154		01.10 03.09 01.11 03.09 01.11 03.09	06.12 06.12 06.12 06.12 06.12 06.12	G2112157	+ 15" wheel <sup>1)</sup>	278 11,9 10,0 +S +C	
<b>SAAB 9-5 Saloon (YS3E) (97-10)</b>									
	1.9 TiD 2.0 2.0 t 2.0 T 2.0 t BioPower 2.0 t BioPower 2.0 Turbo SE 2.2 TiD 2.3 t 2.3 T 2.3 t 2.3 T 2.3 T 2.3 T 2.3 T 2.3 T 2.3 T Aero 2.3 T Aero 2.3 T Aero 2.3 t BioPower 2.3 t BioPower 2.3 t BioPower 3.0 t 3.0 TiD	110 136 110 129 110 132 141 88 125 134 136 162 188 191 169 184 225 136 152 154 147 130		01.06 07.00 09.97 10.98 01.05 06.06 10.98 03.02 09.97 04.08 01.01 07.03 04.08 11.05 01.00 09.01 04.03 01.07 11.06 01.07 01.98 07.01	02.10 02.10 02.10 02.10 02.10 02.10 07.00 02.10 02.10 02.10 02.10 02.10 02.10 02.10 02.10 02.10 02.10 02.10 02.10 02.10 02.10 02.10 02.10 02.10	G1020642 G1020403	+ 16" wheel <sup>6)</sup>	23116 19,8 +/Wl 21829 20,3 +/WD	ATE ATE
	1.9 TiD 2.0 2.0 t 2.0 T 2.0 t BioPower 2.0 t BioPower 2.0 Turbo SE 2.2 TiD 2.3 t 2.3 T 2.3 t 2.3 T 2.3 T 2.3 T 2.3 T 2.3 T 2.3 T 2.3 T 2.3 T 2.3 t BioPower	110 136 110 129 110 132 141 88 125 134 136 162 188 191 169 184 225 136 152 154 147 130		01.06 07.00 09.97 10.98 01.05 06.06 10.98 03.02 09.97 04.08 01.01 07.03 04.08 11.05 01.00 09.01 04.03 01.07 11.06 01.07 01.98 07.01	02.10 02.10 02.10 02.10 02.10 02.10 07.00 02.10 02.10 02.10 02.10 02.10 02.10 02.10 02.10 02.10 02.10 02.10 02.10 02.10 02.10 02.10 02.10 02.10	G2125119	+ 15" wheel <sup>1)</sup>	288 25,0 22,0 V L +S +C	

<sup>1)</sup> + ruota 15" / + roue 15" / + rueda 15" / + 15" Rad

<sup>2)</sup> + ruota 15"/16" / + pistone acciaio / + roue 15"/16" / + piston acier / + rueda 15"/16" / + pistón acero / + 15"/16" Rad/ + Stahlkolben

<sup>3)</sup> + ruota 15"/16" / + pistone plastica / + roue 15"/16" / + piston plastique / + rueda 15"/16" / + pistón plástico / + 15"/16" Rad/ + Kunststoffkolben

<sup>4)</sup> + ruota 16" plus / + roue 16" plus / + rueda 16" plus / + 16" plus Rad

<sup>5)</sup> + ruota 17" / + roue 17" / + rueda 17" / + 17" Rad

<sup>6)</sup> + ruota 16" / + roue 16" / + rueda 16" / + 16" Rad



**SAAB 9-5 Saloon (YS3E) (97-10)**

	2.3 t BioPower	152		11.06	02.10	G2125119	+ 15" wheel <sup>1)</sup>	288 25,0 22,0 V L +S +C
	2.3 t BioPower	154		01.07	02.10			
	2.3 T	162	43510122	07.03	02.10	G2125142	+ 16" wheel <sup>2)</sup>	308 25,0 23,0 V L +S +C
	2.3 T	188		04.08	02.10			
	2.3 T	191		11.05	02.10			
	2.3 T Aero	169		10.99	09.01			
	2.3 T Aero	184		09.01	02.10			
	2.3 T Aero	225		04.03	03.04			
3.0 t	147		01.98	02.10				
3.0 TiD	130		07.01	02.10				
	2.0 t	110	X3025751	09.97		G1020271		21050 15,0 ATE
	2.0 T	129	X3025751	10.98				
	2.0 Turbo SE	141	X3025751	10.98				
	2.3 t	125	X3025751	09.97				
	3.0 t	147	X3025751	01.98				
	1.9 TiD	110		01.06	02.10	G1020316		20180 17,1 +/WD ATE
	2.0	136		07.00	02.10			
	2.0 t	110	X3025752		02.10			
	2.0 T	129	X3025752		02.10			
	2.0 t BioPower	110		01.05	02.10			
	2.0 t BioPower	132		06.06	02.10			
2.0 Turbo SE	141	X3025752		07.00				
2.2 TiD	88		03.02	02.10				
2.3 t	125	X3025752		02.10				
2.3 T	134		04.08	02.10				
2.3 t	136		01.01	02.10				
2.3 T	162		07.03	02.10				
2.3 T	188		04.08	02.10				
2.3 T	191		11.05	02.10				
2.3 T Aero	169		10.99	09.01				
2.3 T Aero	184		09.01	02.10				
2.3 T Aero	225		04.03	03.04				
2.3 t BioPower	136		01.07	02.10				
2.3 t BioPower	152		11.06	02.10				
2.3 t BioPower	154		01.07	02.10				
3.0 t	147	X3025752		02.10				
3.0 TiD	130		07.01	02.10				

**SAAB 9-5 Estate (YS3E) (98-10)**

	1.9 TiD	110		01.06	02.10	G1020642 G1020403	+ 16" wheel <sup>2)</sup>	23116 19,8 +/WL 21829 20,3 +/WD ATE
	1.9 TiD	129		01.07	02.10			
	2.0	136		07.00	07.01			
	2.0 t			10.98	02.10			
	2.0 t	110		10.98	02.10			
	2.0 t BioPower			06.06	02.10			
	2.0 t BioPower	110		01.06	02.10			
	2.2 TiD	88		03.02	02.10			
	2.3	224		06.03	08.05			
	2.3 t	125		10.98	02.10			
	2.3 t	136		01.02	02.10			
	2.3 T	162		07.03	02.10			
	2.3 T	188		04.08	02.10			
	2.3 T	191		01.06	02.10			
	2.3 T Aero	169		10.99	09.01			
	2.3 T Aero	184		09.01	02.10			
	2.3 T Aero	225		04.03	03.04			
	2.3 t BioPower	136		01.07	02.10			
	2.3 t BioPower	152		11.06	02.10			
2.3 t BioPower	154		01.07	02.10				
3.0 t	147		10.98	02.10				
3.0 TiD	130		07.01	02.10				
	1.9 TiD	110		01.06	02.10	G2125119	+ 15" wheel <sup>1)</sup>	288 25,0 22,0 V L +S +C
	1.9 TiD	129		01.07	02.10			
	2.0	136		07.00	07.01			
	2.0 t			10.98	02.10			
	2.0 t	110		10.98	02.10			
	2.0 t BioPower			06.06	02.10			
	2.0 t BioPower	110		01.06	02.10			
	2.2 TiD	88		03.02	02.10			
	2.3 t	125		10.98	02.10			
	2.3 t	136		01.01	02.10			
	2.3 T	162	43510123		02.10 + USA			
	2.3 T	162		07.03	02.10 - USA			
	2.3 t BioPower	136		01.07	02.10			
	2.3 t BioPower	152		11.06	02.10			
2.3 t BioPower	154		01.07	02.10				
3.0 t	147		10.98	02.10				
	2.0	136		07.00	07.01	G2125142	+ 16" wheel <sup>2)</sup>	308 25,0 23,0 V L +S +C
	2.0 t			10.98	02.10			
	2.0 t	110		10.98	02.10			
	2.3	224		06.03	08.05			
	2.3 t	125		10.98	02.10			
	2.3 T	162	43510122	07.03	02.10 + USA			
	2.3 T	188		04.08	02.10			
2.3 T	191		01.06	02.10				
2.3 T Aero	169		10.99	09.01				
2.3 T Aero	184		09.01	02.10				

<sup>1)</sup> + ruota 15" / + roue 15" / + rueda 15" / + 15" Rad  
<sup>2)</sup> + ruota 16" / + roue 16" / + rueda 16" / + 16" Rad





SAAB 9-5 Estate (YS3E) (98-10)									
	2.3 T Aero	225		04.03	03.04	G2125142	+ 16" wheel <sup>1)</sup>	308 25,0 23,0 V L +S +C	
	2.3 t BioPower	136		01.07	02.10				
	2.3 t BioPower	152		11.06	02.10				
	2.3 t BioPower	154		01.07	02.10				
	3.0 t	147		10.98	02.10				
	3.0 TiD	130		07.01	02.10				
	2.0	136	X3025751	07.00		G1020271		21050 15,0	ATE
	2.0 t		X3025751	10.98					
	2.0 t	110	X3025751	10.98					
	2.0 t BioPower		X3025751	06.06					
	2.0 t BioPower	110	X3025751	01.06					
	2.3 t	125	X3025751	10.98					
	2.3 t BioPower	136	X3025751	01.07					
	2.3 t BioPower	152	X3025751	11.06					
	2.3 t BioPower	154	X3025751	01.07					
	3.0 t	147	X3025751	10.98					
	1.9 TiD	110		01.06	02.10	G1020316		20180 17,1 +/WD	ATE
	1.9 TiD	129		01.07	02.10				
	2.0	136	X3025752	07.01					
	2.0 t		X3025752	02.10					
	2.0 t	110	X3025752	02.10					
	2.0 t BioPower		X3025752	02.10					
	2.0 t BioPower	110	X3025752	02.10					
	2.2 TiD	88		03.02	02.10				
	2.3	224		06.03	08.05				
	2.3 t	125	X3025752	02.10					
	2.3 t	136		01.01	02.10				
	2.3 T	162		07.03	02.10				
	2.3 T	188		04.08	02.10				
	2.3 T	191		01.06	02.10				
	2.3 T Aero	169		10.99	09.01				
	2.3 T Aero	184		09.01	02.10				
	2.3 T Aero	225		04.03	03.04				
	2.3 t BioPower	136	X3025752	02.10					
	2.3 t BioPower	152	X3025752	02.10					
	2.3 t BioPower	154	X3025752	02.10					
	3.0 t	147	X3025752	02.10					
	3.0 TiD	130		07.01	02.10				

SAAB 9-5 II (10-12)									
	1.6 T	132		03.10	06.12	G1201143	+ 16" wheel <sup>1)</sup>	24415 19,1 +/WI/Acc	MAN
	2.0 T	162		03.10	06.12				
	2.0 T BioPower	162		03.10	06.12				
	2.0 T BioPower XWD	162		03.10	06.12				
	2.0 T XWD	162		03.10	06.12				
	2.0 TiD	118		03.10	06.12				
	2.0 TTiD	140		03.10	06.12				
	2.0 TTiD XWD	140		03.10	06.12				
	2.8 T V6 XWD	221		03.10	06.12				
		1.6 T	132		03.10				
2.0 T		162		03.10	06.12				
2.0 T BioPower		162		03.10	06.12				
2.0 T BioPower XWD		162		03.10	06.12				
2.0 T XWD		162		03.10	06.12				
2.0 TiD		118		03.10	06.12				
2.0 TTiD		140		03.10	06.12				
2.0 TTiD XWD		140		03.10	06.12				
2.8 T V6 XWD		221		03.10	06.12				
		1.6 T	132		03.10	06.12	G1201147	+ 17+" wheel <sup>3)</sup>	24418 17,0 +/WI/Acc
	2.0 T	162		03.10	06.12				
	2.0 T BioPower	162		03.10	06.12				
	2.0 T BioPower XWD	162		03.10	06.12				
	2.0 T XWD	162		03.10	06.12				
	2.0 TiD	118		03.10	06.12				
	2.0 TTiD	140		03.10	06.12				
	2.0 TTiD XWD	140		03.10	06.12				
	2.8 T V6 XWD	221		03.10	06.12				
		1.6 T	132		03.10	06.12			
2.0 T		162		03.10	06.12				
2.0 T BioPower		162		03.10	06.12				
2.0 T BioPower XWD		162		03.10	06.12				
2.0 T XWD		162		03.10	06.12				
2.0 TiD		118		03.10	06.12				
2.0 TTiD		140		03.10	06.12				
2.0 TTiD XWD		140		03.10	06.12				
2.8 T V6 XWD		221		03.10	06.12				

SAAB 900 (94-98)									
	2.0 16V Turbo			09.93	08.96	G1020369		21411 17,5 +	ATE
	2.0 i			09.93	08.96				
	2.3 16V			09.93	08.96				
	2.5 V6			09.93	08.96				
	2.0 16V Turbo			09.96	03.98	G1020403 G1020642		21829 20,3 +/WD 23116 19,8 +/WI	ATE ATE
	2.0 i			09.96	03.98				
	2.3 16V			09.96	03.98				
	2.5 V6			09.96	03.98				

1) + ruota 16" / + roue 16" / + rueda 16" / + 16" Rad  
2) + ruota 17" / + roue 17" / + rueda 17" / + 17" Rad  
3) + ruota 17+" / + roue 17+" / + rueda 17+" / + 17+" Rad  
4) + ruota 16"/17" / + roue 16"/17" / + ruedas 16"/17" / + 16"/17" Rad





### SAAB 900 (94-98)















	2.0 16V Turbo 2.0 i 2.3 16V 2.5 V6			09.96 09.96 09.96 09.96	03.98 03.98 03.98 03.98		G2125119		288 25,0 22,0 V L +S +C	
	2.0 16V Turbo 2.0 i 2.3 16V 2.5 V6			09.93 09.93 09.93 09.93	08.96 08.96 08.96 08.96		G1020272		21140 15,0	ATE
	2.0 16V Turbo 2.0 i 2.3 16V 2.5 V6			09.96 09.96 09.96 09.96	03.98 03.98 03.98 03.98		G1020271		21050 15,0	ATE

### SEAT ALHAMBRA I (96-10)

	1.8 T 20V 1.9 TDI 1.9 TDI 2.0 i	110 66 81 85	7M-W-070000 7M-W-070000 7M-W-070000 7M-W-070000	05.98 03.96 10.97 03.96			G1020312 G1020557		21624 20,3 + 21849 19,8 +/Wl	ATE ATE
	1.8 T 20V 1.9 TDI 1.9 TDI 1.9 TDI 2.0 i	110 66 81 85 85	7M-X-000001 7M-X-000001 7M-X-000001 7M-X-000001 7M-X-000001		05.00		G1020557		21849 19,8 +/Wl	ATE
	1.9 TDI 1.9 TDI 1.9 TDI 2.0 i 2.0 TDI	66 85 96 85 103	7M-2-500001 7M-2-500001 7M-2-500001 7M-2-500001 7M-2-500001		08.10 08.10 11.02 08.10 08.10		G1020593		23418 19,4 +/Wl	ATE
	1.8 T 20V 1.9 TDI 1.9 TDI 4motion 1.9 TDI 4motion 2.8 i V6 2.8 i V6 4motion	110 110 85 96 150 150	7M-2-500001 7M-2-500001 7M-2-500001 7M-2-500001 7M-2-500001 7M-2-500001		08.10 05.05 02.01 06.05 06.00 02.01	08.10 08.10 08.10 08.10 08.10 08.10	G1020580		23269 19,8 +/Wl	ATE
	1.8 T 20V 1.9 TDI 1.9 TDI 1.9 TDI 2.0 i	110 66 81 85 85	7M-1-530756 7M-1-530756 7M-1-530756 7M-1-530756 7M-1-530756	05.98 03.96 10.97 06.00 03.96	05.00		G2125114		288 25,1 21,0 V L +S +C	
	1.8 T 20V 1.9 TDI 1.9 TDI 2.0 i	110 66 81 85		05.98 03.96 10.97 03.96	05.00 05.00 05.00 05.00		G1020549		20961 17,1 /WD/S	LUC
	1.8 T 20V 1.9 TDI 1.9 TDI 1.9 TDI 2.0 i 2.0 TDI	110 66 85 96 85 103	7M-1-530756	06.00 06.00 06.00 11.02 06.00 11.05	08.10 08.10 08.10 08.10 08.10 08.10		G1020564		20961 16,8 +/Wl/Acc/S	LUC
	1.8 T 20V 1.9 TDI 1.9 TDI 4motion 1.9 TDI 4motion 2.8 i V6 2.8 i V6 4motion	110 110 85 96 150 150	7M-2-500001		08.10 05.05 02.01 06.05 06.00 02.01	08.10 08.10 08.10 08.10 08.10 08.10	G1020654		23446 16,5 +/Wl/Acc/S	LUC
	1.8 T 20V 1.9 TDI 1.9 TDI 1.9 TDI 1.9 TDI 2.0 i 2.0 TDI	110 66 81 85 96 85 103	7M-1-530756	05.98 03.96 10.97 06.00 11.02 03.96 11.05	05.00 08.10 05.00 08.10 08.10 08.10 08.10		G2110223		268 10,0 8,0 +S +C	

### SEAT ALHAMBRA II (10-)

	1.4 TSI 1.8 TFSI 2.0 TDI 2.0 TDI 2.0 TDI 2.0 TDI 2.0 TDI 2.0 TDI 2.0 TDI 4motion 2.0 TSI	110 118 85 100 103 125 130 103 147		09.10 11.12 04.11 09.10 06.10 09.10 11.12 04.11 09.10	PR: 1LJ PR: 1LJ PR: 1LJ PR: 1LJ PR: 1LJ PR: 1LJ PR: 1LJ PR: 1LJ PR: 1LJ PR: 1LJ		G1020992		24332 19,8 +/Wl	ATE
	1.4 TSI 1.8 TFSI 2.0 TDI 2.0 TDI 2.0 TDI 2.0 TDI 2.0 TDI 2.0 TDI 2.0 TDI 4motion 2.0 TSI	110 118 85 100 103 125 130 103 147		09.10 11.12 04.11 09.10 06.10 09.10 11.12 04.11 09.10	PR: 1LJ PR: 1LJ PR: 1LJ PR: 1LJ PR: 1LJ PR: 1LJ PR: 1LJ PR: 1LJ PR: 1LJ PR: 1LJ		G2125158		312 25,0 22,0 V L +S +C	

							
<b>SEAT ALHAMBRA II (10-)</b>							
	1.4 TSI	110	09.10		G1020993		24483 16,9 /Acc/S LUC
	1.8 TFSI	118	11.12				
	2.0 TDI	85	04.11				
	2.0 TDI	100	09.10				
	2.0 TDI	103	06.10				
	2.0 TDI	125	09.10				
	2.0 TDI	130	11.12				
	2.0 TDI 4motion	103	04.11				
	2.0 TSI	147	09.10				
	1.4 TSI	110	09.10		G2112169		282 12,0 10,0 +S +C
	1.8 TFSI	118	11.12				
	2.0 TDI	85	04.11				
	2.0 TDI	100	09.10				
	2.0 TDI	103	06.10				
	2.0 TDI	125	09.10				
	2.0 TDI	130	11.12				
	2.0 TDI 4motion	103	04.11				
	2.0 TSI	147	09.10				
<b>SEAT ALTEA (5P1) (04-)</b>							
	1.2 TSI	77	04.10	PR: 1ZF	G1020463		23131 19,7 +/Wl VW
	1.4 i 16V	63	05.06	PR: 1ZF			
	1.4 TSI	92	11.07	PR: 1ZF			
	1.6 i 16V	75	03.04	PR: 1ZF			
	1.6 LPG	75	09.09	PR: 1ZF			
	1.6 TDI	75	10.09	PR: 1ZF			
	1.8 TFSI	118	01.07	PR: 1ZF			
	1.9 TDI	110	03.04	PR: 1ZF			
	2.0 FSI	110	03.04	PR: 1ZF			
	2.0 i 16V	100	03.04	PR: 1ZF			
	2.0 TDI	100	03.04	PR: 1ZF			
	2.0 TDI	103	03.04	PR: 1ZF			
	2.0 TDI	125	03.06	PR: 1ZF			
	2.0 TFSI	147	03.06	PR: 1ZF			
		1.2 TSI	77	04.10	PR: 1ZA,1ZE,1LJ	G1020680	
1.4 i 16V		63	05.06	PR: 1ZA,1ZE,1LJ			
1.4 TSI		92	11.07	PR: 1ZA,1ZE,1LJ			
1.6 i 16V		75	03.04	PR: 1ZA,1ZE,1LJ			
1.6 LPG		75	09.09	PR: 1ZA,1ZE,1LJ			
1.6 TDI		75	10.09	PR: 1ZA,1ZE,1LJ			
1.8 TFSI		118	01.07	PR: 1ZA,1ZE,1LJ			
1.9 TDI		110	03.04	PR: 1ZA,1ZE,1LJ			
2.0 FSI		110	03.04	PR: 1ZA,1ZE,1LJ			
2.0 i 16V		100	03.04	PR: 1ZA,1ZE,1LJ			
2.0 TDI		100	03.04	PR: 1ZA,1ZE,1LJ			
2.0 TDI		103	03.04	PR: 1ZA,1ZE,1LJ			
2.0 TDI		125	03.06	PR: 1ZA,1ZE,1LJ			
2.0 TFSI		147	03.06	PR: 1ZA,1ZE,1LJ			
		1.2 TSI	77	04.10	PR: 1ZE	G2122210	
	1.4 i 16V	63	05.06	PR: 1ZE			
	1.4 TSI	92	11.07	PR: 1ZE			
	1.6 i 16V	75	03.04	PR: 1ZE			
	1.6 LPG	75	09.09	PR: 1ZE			
	1.6 TDI	75	10.09	PR: 1ZE			
	1.8 TFSI	118	01.07	PR: 1ZE			
	1.9 TDI	110	03.04	PR: 1ZE			
	2.0 FSI	110	03.04	PR: 1ZE			
	2.0 i 16V	100	03.04	PR: 1ZE			
	2.0 TDI	100	03.04	PR: 1ZE			
	2.0 TDI	103	03.04	PR: 1ZE			
	2.0 TDI	125	03.06	PR: 1ZE			
	2.0 TFSI	147	03.06	PR: 1ZE			
		1.2 TSI	77	04.10	PR: 1LJ,1ZA	G2125145	
1.4 i 16V		63	05.06	PR: 1LJ,1ZA			
1.4 TSI		92	11.07	PR: 1LJ,1ZA			
1.6 i 16V		75	03.04	PR: 1LJ,1ZA			
1.6 LPG		75	09.09	PR: 1LJ,1ZA			
1.6 TDI		75	10.09	PR: 1LJ,1ZA			
1.8 TFSI		118	01.07	PR: 1LJ,1ZA			
1.9 TDI		110	03.04	PR: 1LJ,1ZA			
2.0 FSI		110	03.04	PR: 1LJ,1ZA			
2.0 i 16V		100	03.04	PR: 1LJ,1ZA			
2.0 TDI		100	03.04	PR: 1LJ,1ZA			
2.0 TDI		103	03.04	PR: 1LJ,1ZA			
2.0 TDI		125	03.06	PR: 1ZE			
2.0 TFSI		147	03.06	PR: 1ZE			
		1.2 TSI	77	04.10	PR: 1LJ,1ZA	G2125158	
	1.4 i 16V	63	05.06	PR: 1LJ,1ZA			
	1.4 TSI	92	11.07	PR: 1LJ,1ZA			
	1.6 i 16V	75	03.04	PR: 1LJ,1ZA			
	1.6 LPG	75	09.09	PR: 1LJ,1ZA			
	1.6 TDI	75	10.09	PR: 1LJ,1ZA			
	1.8 TFSI	118	01.07	PR: 1LJ,1ZA			
	1.9 TDI	110	03.04	PR: 1LJ,1ZA			
	2.0 FSI	110	03.04	PR: 1LJ,1ZA			
	2.0 i 16V	100	03.04	PR: 1LJ,1ZA			
	2.0 TDI	100	03.04	PR: 1LJ,1ZA			
	2.0 TDI	103	03.04	PR: 1LJ,1ZA			
	2.0 TDI	125	03.06	PR: 1ZE			
	2.0 TFSI	147	03.06	PR: 1ZE			





**SEAT ALTEA (5P1) (04-)**

	2.0 TDI 2.0 TDI 2.0 TFSI	103 125 147	03.04 03.06 03.06	PR: 1LJ,1ZA PR: 1LJ,1ZA PR: 1LJ,1ZA	G2125158		312 25,0 22,0 V L +S +C
	1.2 TSI 1.4 i 16V 1.4 TSI 1.6 i 16V 1.6 LPG 1.6 TDI 1.8 TFSI 1.9 TDI 2.0 FSI 2.0 i 16V 2.0 TDI 2.0 TDI 2.0 TDI 2.0 TFSI	77 63 92 75 75 118 110 100 100 103 125 147	04.10 05.06 11.07 03.04 09.09 10.09 01.07 03.04 03.04 03.04 03.04 03.04 03.06 03.06	PR: 1KD,1KQ,1KZ PR: 1KD,1KQ,1KZ PR: 1KD,1KQ,1KZ PR: 1KD,1KQ,1KZ PR: 1KD,1KQ,1KZ PR: 1KD,1KQ,1KZ PR: 1KD,1KQ,1KZ PR: 1KD,1KQ,1KZ PR: 1KD,1KQ,1KZ PR: 1KD,1KQ,1KZ PR: 1KD,1KQ,1KZ PR: 1KD,1KQ,1KZ PR: 1KD,1KQ,1KZ PR: 1KD,1KQ,1KZ	G1020492		23554 17,1 /WD/S LUC
	1.2 TSI 1.4 i 16V 1.4 TSI 1.6 i 16V 1.6 LPG 1.6 TDI 1.8 TFSI 1.9 TDI 2.0 FSI 2.0 i 16V 2.0 TDI 2.0 TDI 2.0 TDI 2.0 TFSI	77 63 92 75 75 118 110 100 100 103 125 147	04.10 05.06 11.07 03.04 09.09 10.09 01.07 03.04 03.04 03.04 03.04 03.04 03.06 03.06	PR: 1KD,1KQ,1KZ PR: 1KD,1KQ,1KZ PR: 1KD,1KQ,1KZ PR: 1KD,1KQ,1KZ PR: 1KD,1KQ,1KZ PR: 1KD,1KQ,1KZ PR: 1KD,1KQ,1KZ PR: 1KD,1KQ,1KZ PR: 1KD,1KQ,1KZ PR: 1KD,1KQ,1KZ PR: 1KD,1KQ,1KZ PR: 1KD,1KQ,1KZ PR: 1KD,1KQ,1KZ PR: 1KD,1KQ,1KZ	G1020682		23914 17,1 /WD/Acc/S LUC
	1.2 TSI 1.4 i 16V 1.4 TSI 1.6 i 16V 1.6 LPG 1.6 TDI 1.8 TFSI 1.9 TDI 2.0 FSI 2.0 i 16V 2.0 TDI 2.0 TDI 2.0 TDI 2.0 TFSI	77 63 92 75 75 118 110 100 100 103 125 147	04.10 05.06 11.07 03.04 09.09 10.09 01.07 03.04 03.04 03.04 03.04 03.06 03.06	PR: 1KD,1KQ PR: 1KD,1KQ PR: 1KD,1KQ PR: 1KD,1KQ PR: 1KD,1KQ PR: 1KD,1KQ PR: 1KD,1KQ PR: 1KD,1KQ PR: 1KD,1KQ PR: 1KD,1KQ PR: 1KD,1KQ PR: 1KD,1KQ PR: 1KD,1KQ	G2110277		253 10,0 8,0 +S +C
	1.2 TSI 1.4 i 16V 1.4 TSI 1.6 i 16V 1.6 LPG 1.6 TDI 1.8 TFSI 1.9 TDI 2.0 FSI 2.0 i 16V 2.0 TDI 2.0 TDI 2.0 TDI 2.0 TFSI	77 63 92 75 75 118 110 100 100 103 125 147	04.10 05.06 11.07 03.04 09.09 10.09 01.07 03.04 03.04 03.04 03.04 03.06 03.06	PR: 1KJ,1KZ PR: 1KJ,1KZ PR: 1KJ,1KZ PR: 1KJ,1KZ PR: 1KJ,1KZ PR: 1KJ,1KZ PR: 1KJ,1KZ PR: 1KJ,1KZ PR: 1KJ,1KZ PR: 1KJ,1KZ PR: 1KJ,1KZ PR: 1KJ,1KZ PR: 1KJ,1KZ	G2112169		282 12,0 10,0 +S +C
	1.2 TSI 1.4 i 16V 1.4 TSI 1.6 i 16V 1.6 LPG 1.6 TDI 1.8 TFSI 1.9 TDI 2.0 FSI 2.0 i 16V 2.0 TDI 2.0 TDI 2.0 TDI 2.0 TFSI	77 63 92 75 75 118 110 100 100 103 125 147	04.10 05.06 11.07 03.04 09.09 10.09 01.07 03.04 03.04 03.04 03.04 03.06 03.06	PR: 1KS PR: 1KS PR: 1KS PR: 1KS PR: 1KS PR: 1KS PR: 1KS PR: 1KS PR: 1KS PR: 1KS PR: 1KS PR: 1KS PR: 1KS	G2110356		272 9,7 8,0 +S +C

**SEAT ALTEA XL (5P5) (06-)**

	1.2 TSI 1.4 i 16V 1.4 TSI 1.6 i 16V 1.6 LPG 1.6 TDI 1.8 TFSI 1.9 TDI 2.0 FSI 2.0 TDI 2.0 TDI 2.0 TDI 4x4	77 63 92 75 75 118 110 125	04.10 05.08 11.07 10.06 09.09 10.09 10.06 10.06 10.06 10.06 10.06 06.07	PR: 1ZF PR: 1ZF PR: 1ZF PR: 1ZF PR: 1ZF PR: 1ZF PR: 1ZF PR: 1ZF PR: 1ZF PR: 1ZF PR: 1ZF	G1020463		23131 19,7 +/Wl VW
--	---	---	--	---	----------	--	--------------------



**SEAT ALTEA XL (5P5) (06-)**

	2.0 TFSI 4x4		06.07	PR: 1ZF	G1020463		23131 19,7 +/WI	VW
	1.2 TSI	77	04.10	PR: 1ZA,1ZE,1LJ	G1020680		23587 20,6 +/WI	ATE
	1.4 i 16V	63	05.08	PR: 1ZA,1ZE,1LJ				
	1.4 TSI	92	11.07	PR: 1ZA,1ZE,1LJ				
	1.6 i 16V	75	10.06	PR: 1ZA,1ZE,1LJ				
	1.6 LPG	75	09.09	PR: 1ZA,1ZE,1LJ				
	1.6 TDI		10.09	PR: 1ZA,1ZE,1LJ				
	1.8 TFSI	118	10.06	PR: 1ZA,1ZE,1LJ				
	1.9 TDI		10.06	PR: 1ZA,1ZE,1LJ				
	2.0 FSI	110	10.06	PR: 1ZA,1ZE,1LJ				
	2.0 TDI		10.06	PR: 1ZA,1ZE,1LJ				
	2.0 TDI	125	10.06	PR: 1ZA,1ZE,1LJ				
	2.0 TDI 4x4		06.07	PR: 1ZA,1ZE,1LJ				
	2.0 TFSI 4x4		06.07	PR: 1ZA,1ZE,1LJ				
	1.2 TSI	77	04.10	PR: 1ZF	G2122210		280 22,0 19,0 V L +S +C	
	1.4 i 16V	63	05.08	PR: 1ZF				
	1.4 TSI	92	11.07	PR: 1ZF				
	1.6 i 16V	75	10.06	PR: 1ZF				
	1.6 LPG	75	09.09	PR: 1ZF				
	1.6 TDI		10.09	PR: 1ZF				
	1.8 TFSI	118	10.06	PR: 1ZF				
	1.9 TDI		10.06	PR: 1ZF				
	2.0 FSI	110	10.06	PR: 1ZF				
	2.0 TDI		10.06	PR: 1ZF				
	2.0 TDI	125	10.06	PR: 1ZF				
	2.0 TDI 4x4		06.07	PR: 1ZF				
	2.0 TFSI 4x4		06.07	PR: 1ZF				
	1.2 TSI	77	04.10	PR: 1ZE	G2125145		288 25,0 22,0 V L +S +C	
	1.4 i 16V	63	05.08	PR: 1ZE				
	1.4 TSI	92	11.07	PR: 1ZE				
	1.6 i 16V	75	10.06	PR: 1ZE				
	1.6 LPG	75	09.09	PR: 1ZE				
	1.6 TDI		10.09	PR: 1ZE				
	1.8 TFSI	118	10.06	PR: 1ZE				
	1.9 TDI		10.06	PR: 1ZE				
	2.0 FSI	110	10.06	PR: 1ZE				
	2.0 TDI		10.06	PR: 1ZE				
	2.0 TDI	125	10.06	PR: 1ZE				
	2.0 TDI 4x4		06.07	PR: 1ZE				
	2.0 TFSI 4x4		06.07	PR: 1ZE				
	1.2 TSI	77	04.10	PR: 1LJ,1ZA	G2125158		312 25,0 22,0 V L +S +C	
	1.4 i 16V	63	05.08	PR: 1LJ,1ZA				
	1.4 TSI	92	11.07	PR: 1LJ,1ZA				
	1.6 i 16V	75	10.06	PR: 1LJ,1ZA				
	1.6 LPG	75	09.09	PR: 1LJ,1ZA				
	1.6 TDI		10.09	PR: 1LJ,1ZA				
	1.8 TFSI	118	10.06	PR: 1LJ,1ZA				
	1.9 TDI		10.06	PR: 1LJ,1ZA				
	2.0 FSI	110	10.06	PR: 1LJ,1ZA				
	2.0 TDI		10.06	PR: 1LJ,1ZA				
	2.0 TDI	125	10.06	PR: 1LJ,1ZA				
	2.0 TDI 4x4		06.07	PR: 1LJ,1ZA				
	2.0 TFSI 4x4		06.07	PR: 1LJ,1ZA				
	1.2 TSI	77	04.10	PR: 1KD,1KQ,1KZ	G1020492		23554 17,1 /WD/S	LUC
	1.4 i 16V	63	05.08	PR: 1KD,1KQ,1KZ				
	1.4 TSI	92	11.07	PR: 1KD,1KQ,1KZ				
	1.6 i 16V	75	10.06	PR: 1KD,1KQ,1KZ				
	1.6 LPG	75	09.09	PR: 1KD,1KQ,1KZ				
	1.6 TDI		10.09	PR: 1KD,1KQ,1KZ				
	1.8 TFSI	118	10.06	PR: 1KD,1KQ,1KZ				
	1.9 TDI		10.06	PR: 1KD,1KQ,1KZ				
	2.0 FSI	110	10.06	PR: 1KD,1KQ,1KZ				
	2.0 TDI		10.06	PR: 1KD,1KQ,1KZ				
	2.0 TDI	125	10.06	PR: 1KD,1KQ,1KZ				
	2.0 TDI 4x4		06.07	PR: 1KD,1KQ,1KZ				
	2.0 TFSI 4x4		06.07	PR: 1KD,1KQ,1KZ				
	1.2 TSI	77	04.10	PR: 1KD,1KQ,1KZ	G1020682		23914 17,1 /WD/Acc/S	LUC
	1.4 i 16V	63	05.08	PR: 1KD,1KQ,1KZ				
	1.4 TSI	92	11.07	PR: 1KD,1KQ,1KZ				
	1.6 i 16V	75	10.06	PR: 1KD,1KQ,1KZ				
	1.6 LPG	75	09.09	PR: 1KD,1KQ,1KZ				
	1.6 TDI		10.09	PR: 1KD,1KQ,1KZ				
	1.8 TFSI	118	10.06	PR: 1KD,1KQ,1KZ				
	1.9 TDI		10.06	PR: 1KD,1KQ,1KZ				
	2.0 FSI	110	10.06	PR: 1KD,1KQ,1KZ				
	2.0 TDI		10.06	PR: 1KD,1KQ,1KZ				
	2.0 TDI	125	10.06	PR: 1KD,1KQ,1KZ				
	2.0 TDI 4x4		06.07	PR: 1KD,1KQ,1KZ				
	2.0 TFSI 4x4		06.07	PR: 1KD,1KQ,1KZ				
	1.2 TSI	77	04.10	PR: 1KD,1KQ	G2110277		253 10,0 8,0 +S +C	
	1.4 i 16V	63	05.08	PR: 1KD,1KQ				
	1.4 TSI	92	11.07	PR: 1KD,1KQ				
	1.6 i 16V	75	10.06	PR: 1KD,1KQ				
	1.6 LPG	75	09.09	PR: 1KD,1KQ				
	1.6 TDI		10.09	PR: 1KD,1KQ				
	1.8 TFSI	118	10.06	PR: 1KD,1KQ				





### SEAT ALTEA XL (5P5) (06-)

	1.9 TDI	110	10.06	PR: 1KD,1KQ	G2110277		253 10,0 8,0 +S +C
	2.0 FSI		10.06	PR: 1KD,1KQ			
	2.0 TDI		10.06	PR: 1KD,1KQ			
	2.0 TDI	125	10.06	PR: 1KD,1KQ			
	2.0 TDI 4x4		06.07	PR: 1KD,1KQ			
	2.0 TFSI 4x4		06.07	PR: 1KD,1KQ			
	1.2 TSI	77	04.10	PR: 1KJ,1KZ	G2112169		282 12,0 10,0 +S +C
	1.4 i 16V	63	05.08	PR: 1KJ,1KZ			
	1.4 TSI	92	11.07	PR: 1KJ,1KZ			
	1.6 i 16V	75	10.06	PR: 1KJ,1KZ			
	1.6 LPG	75	09.09	PR: 1KJ,1KZ			
	1.6 TDI		10.09	PR: 1KJ,1KZ			
	1.8 TFSI	118	10.06	PR: 1KJ,1KZ			
	1.9 TDI		10.06	PR: 1KJ,1KZ			
	2.0 FSI	110	10.06	PR: 1KJ,1KZ			
	2.0 TDI		10.06	PR: 1KJ,1KZ			
	2.0 TDI	125	10.06	PR: 1KJ,1KZ			
	2.0 TDI 4x4		06.07	PR: 1KJ,1KZ			
	2.0 TFSI 4x4		06.07	PR: 1KJ,1KZ			
		1.2 TSI	77	04.10			
1.4 i 16V		63	05.08	PR: 1KS			
1.4 TSI		92	11.07	PR: 1KS			
1.6 i 16V		75	10.06	PR: 1KS			
1.6 LPG		75	09.09	PR: 1KS			
1.6 TDI			10.09	PR: 1KS			
1.8 TFSI		118	10.06	PR: 1KS			
1.9 TDI			10.06	PR: 1KS			
2.0 FSI		110	10.06	PR: 1KS			
2.0 TDI			10.06	PR: 1KS			
2.0 TDI		125	10.06	PR: 1KS			
2.0 TDI 4x4			06.07	PR: 1KS			
2.0 TFSI 4x4			06.07	PR: 1KS			

### SEAT AROSA (6H) (97-05)

	1.0 i	37	05.97	04.05	G1020408		21866 17,2 +	VW
	1.4 i	44	05.97	04.05				
	1.7 SDI	44	11.97	04.05				
	1.4 i 16V	74	10.99	04.05	G1020444		21945 16,0 /S	LUC
	1.4 TDI	55	10.99	04.05				
	1.0 i	37	05.97	04.05	G2110232		239 9,9 8,0 +S +C	
	1.0 i	37	05.97	04.05				
	1.4 i	44	05.97	04.05				
	1.7 SDI	44	11.97	04.05				
	1.4 i 16V	74	10.99	04.05	G2120128		256 20,0 18,0 V L +S +C	
	1.4 TDI	55	10.99	04.05				
	1.4 i 16V	74	10.99	04.05	G1020755		20961 17,1 /Acc/S	LUC
	1.4 i 16V	74	10.99	04.05	G2109124		232 9,0 7,0 +C	

### SEAT CORDOBA I (93-99)

	1.4 i		6K-TR09920	11.93	- ABS	G1020025		20889 17,3 /Acc	VW
	1.4 i		6K-TR09921		12.96 - ABS	G1020344		20887 17,3 +/-Acc	VW
	1.4 i		6K-TR046558	11.93	+ ABS	G1020009		20887 19,7 +/-Acc	VW
	1.6 i		6K-TR046558	11.93	+ solid discs <sup>1)</sup>				
	1.8 i	66	6K-TR046558	11.93	+ solid discs <sup>1)</sup>				
	1.9 D		6K-TR046558	11.93	+ solid discs <sup>1)</sup>				
	1.9 TD	55	6K-TR046558	11.93	+ solid discs <sup>1)</sup>				
	1.4 i		6K-TR046559		12.96 + ABS	G1020355		21866 19,7 +	VW
	1.6 i		6K-TR046559		12.96 + solid discs <sup>1)</sup>				
	1.8 i	66	6K-TR046559		12.96 + solid discs <sup>1)</sup>				
	1.9 D		6K-TR046559		12.96 + solid discs <sup>1)</sup>				
	1.9 SDI	47		09.95	12.96 + solid discs <sup>1)</sup>				
	1.9 TD	55	6K-TR046559		12.96 + solid discs <sup>1)</sup>				
	1.6 i			11.93	12.96 + ventilated discs <sup>2)</sup>	G1020010		20887 15,3 +/-Acc	VW
	1.8 i	66		11.93	12.96 + ventilated discs <sup>2)</sup>				
	1.9 D			11.93	12.96 + ventilated discs <sup>2)</sup>				
	1.9 SDI	47		09.95	12.96 + ventilated discs <sup>2)</sup>				
	1.9 TD	55		11.93	12.96 + ventilated discs <sup>2)</sup>				
	1.8 i 16V	95		02.94	12.96	G1020444		21945 16,0 /S	LUC
	2.0 i	85		11.93	12.96				
	1.4 i			01.97	05.99	G1020344		20887 17,3 +/-Acc	VW
	1.6 i			01.97	05.99				
	1.6 i	55		05.97	05.99				
	1.7 SDI	44		07.97	05.99				
	1.8 i	66		01.97	05.99				
	1.8 i 16V	95		01.97	05.99				
	1.9 D			01.97	05.99				
	1.9 SDI	47		01.97	05.99				
	1.9 TD	55		01.97	05.99				
	1.9 TDI	66		01.97	05.99				
	1.9 TDI	81		03.97	05.99				
2.0 i	85		01.97	05.99					

<sup>1)</sup> + dischi massiccio / + disques massive / + disco macizo / + massive Scheiben  
<sup>2)</sup> + dischi ventilati / + disques ventilés / + disco ventilado / + belüftete Scheiben











**SEAT CORDOBA I (93-99)**

	1.4 i 1.6 i 1.6 i 1.7 SDI 1.8 i 1.8 i 16V 1.9 D 1.9 SDI 1.9 TD 1.9 TDI 1.9 TDI 2.0 i			01.97 01.97 05.97 07.97 01.97 01.97 01.97 01.97 01.97 01.97 03.97 01.97	05.99 05.99 05.99 05.99 05.99 05.99 05.99 05.99 05.99 05.99 05.99 05.99	PR: 1LM PR: 1LM PR: 1LM PR: 1LM PR: 1LM PR: 1LM PR: 1LM PR: 1LM PR: 1LM PR: 1LM PR: 1LM PR: 1LM	G1020355		21866 19,7 +	VW
	1.4 i 1.6 i 1.6 i 1.7 SDI 1.8 i 1.8 i 16V 1.9 D 1.9 SDI 1.9 TD 1.9 TDI 1.9 TDI 2.0 i			01.97 01.97 05.97 07.97 01.97 01.97 01.97 01.97 01.97 01.97 03.97 01.97	05.99 05.99 05.99 05.99 05.99 05.99 05.99 05.99 05.99 05.99 05.99 05.99	PR: 1LG PR: 1LG PR: 1LG PR: 1LG PR: 1LG PR: 1LG PR: 1LG PR: 1LG PR: 1LG PR: 1LG PR: 1LG PR: 1LG	G1020390		21866 15,3 +	VW
	1.4 i 1.6 i 1.6 i 1.7 SDI 1.8 i 1.8 i 16V 1.9 D 1.9 SDI 1.9 TD 1.9 TDI 1.9 TDI 2.0 i			01.97 01.97 05.97 07.97 01.97 01.97 01.97 01.97 01.97 01.97 03.97 01.97	05.99 05.99 05.99 05.99 05.99 05.99 05.99 05.99 05.99 05.99 05.99 05.99	PR: 1LY,1ZK PR: 1LY,1ZK PR: 1LY,1ZK PR: 1LY,1ZK PR: 1LY,1ZK PR: 1LY,1ZK PR: 1LY,1ZK PR: 1LY,1ZK PR: 1LY,1ZK PR: 1LY,1ZK PR: 1LY,1ZK PR: 1LY,1ZK	G1020444		21945 16,0 /S	LUC
	1.4 i 1.6 i 1.6 i 1.7 SDI 1.8 i 1.8 i 16V 1.9 D 1.9 SDI 1.9 TD 1.9 TDI 1.9 TDI 2.0 i 2.0 i 16V			01.97 01.97 05.97 07.97 01.97 01.97 01.97 01.97 01.97 01.97 03.97 01.97 07.96	05.99 05.99 05.99 05.99 05.99 05.99 05.99 05.99 05.99 05.99 05.99 05.99 05.99	PR: 1LV,1LW,1LD PR: 1LV,1LW,1LD PR: 1LV,1LW,1LD PR: 1LV,1LW,1LD PR: 1LV,1LW,1LD PR: 1LV,1LW,1LD PR: 1LV,1LW,1LD PR: 1LV,1LW,1LD PR: 1LV,1LW,1LD PR: 1LV,1LW,1LD PR: 1LV,1LW,1LD PR: 1LV,1LW,1LD PR: 1LV,1LW,1LD	G1020274		20168 19,3 /S	LUC
	1.4 i 1.4 i 1.6 i 1.8 i 1.9 D 1.9 SDI 1.9 TD			11.93 11.93 11.93 11.93 11.93 09.95 11.93	12.96 12.96 12.96 12.96 12.96 12.96 12.96	- ABS + ABS + solid discs <sup>1)</sup> + solid discs <sup>1)</sup> + solid discs <sup>1)</sup> + solid discs <sup>1)</sup> + solid discs <sup>1)</sup>	G2110151 G2112106		239 10,0 8,0 +S +C 239 12,0 10,0 +S +C	
	1.4 i 1.6 i 1.8 i 1.9 D 1.9 SDI 1.9 TD			11.93 11.93 11.93 11.93 09.95 11.93	12.96 12.96 12.96 12.96 12.96 12.96	+ ABS + ventilated discs <sup>2)</sup> + ventilated discs <sup>2)</sup> + ventilated discs <sup>2)</sup> + ventilated discs <sup>2)</sup> + ventilated discs <sup>2)</sup>	G2120123		239 20,0 18,0 V L +S +C	
	1.8 i 16V 2.0 i			02.94 11.93	12.96 12.96		G2120128		256 20,0 18,0 V L +S +C	
	1.4 i 1.6 i 1.6 i 1.7 SDI 1.8 i 1.8 i 16V 1.9 D 1.9 SDI 1.9 TD 1.9 TDI 1.9 TDI 2.0 i			01.97 01.97 05.97 07.97 01.97 01.97 01.97 01.97 01.97 01.97 03.97 01.97	05.99 05.99 05.99 05.99 05.99 05.99 05.99 05.99 05.99 05.99 05.99 05.99	PR: 1LA PR: 1LA PR: 1LA PR: 1LA PR: 1LA PR: 1LA PR: 1LA PR: 1LA PR: 1LA PR: 1LA PR: 1LA PR: 1LA	G2110151		239 10,0 8,0 +S +C	
	1.4 i 1.6 i 1.6 i 1.7 SDI 1.8 i 1.8 i 16V 1.9 D 1.9 SDI 1.9 TD 1.9 TDI			01.97 01.97 05.97 07.97 01.97 01.97 01.97 01.97 01.97 01.97	05.99 05.99 05.99 05.99 05.99 05.99 05.99 05.99 05.99 05.99	PR: 1LM PR: 1LM PR: 1LM PR: 1LM PR: 1LM PR: 1LM PR: 1LM PR: 1LM PR: 1LM PR: 1LM	G2112106		239 12,0 10,0 +S +C	

<sup>1)</sup> + dischi massiccio / + disques massive / + disco macizo / + massive Scheiben

<sup>2)</sup> + dischi ventilati / + disques ventilés / + disco ventilado / + belüftete Scheiben



SEAT CORDOBA I (93-99)											
	1.9 TDI	81		03.97	05.99	PR: 1LM	G2112106				239 12,0 10,0 +S +C
	2.0 i	85		01.97	05.99	PR: 1LM					
	1.4 i			01.97	05.99	PR: 1LG	G2120123				239 20,0 18,0 V L +S +C
	1.6 i			01.97	05.99	PR: 1LG					
	1.6 i	55		05.97	05.99	PR: 1LG					
	1.7 SDI	44		07.97	05.99	PR: 1LG					
	1.8 i	66		01.97	05.99	PR: 1LG					
	1.8 i 16V	95		01.97	05.99	PR: 1LG					
	1.9 D			01.97	05.99	PR: 1LG					
	1.9 SDI	47		01.97	05.99	PR: 1LG					
	1.9 TD	55		01.97	05.99	PR: 1LG					
	1.9 TDI	66		01.97	05.99	PR: 1LG					
	1.9 TDI	81		03.97	05.99	PR: 1LG					
	2.0 i	85		01.97	05.99	PR: 1LG					
	1.4 i			01.97	05.99	PR: 1LY,1ZK	G2120128				256 20,0 18,0 V L +S +C
	1.6 i			01.97	05.99	PR: 1LY,1ZK					
	1.6 i	55		05.97	05.99	PR: 1LY,1ZK					
	1.7 SDI	44		07.97	05.99	PR: 1LY,1ZK					
	1.8 i	66		01.97	05.99	PR: 1LY,1ZK					
	1.8 i 16V	95		01.97	05.99	PR: 1LY,1ZK					
	1.9 D			01.97	05.99	PR: 1LY,1ZK					
	1.9 SDI	47		01.97	05.99	PR: 1LY,1ZK					
	1.9 TD	55		01.97	05.99	PR: 1LY,1ZK					
	1.9 TDI	66		01.97	05.99	PR: 1LY,1ZK					
	1.9 TDI	81		03.97	05.99	PR: 1LY,1ZK					
	2.0 i	85		01.97	05.99	PR: 1LY,1ZK					
	1.8 i 16V	95	6K-X-289999	02.94			G1020201				20961 15,2 /WD/Acc/S LUC
	1.9 TDI	81	6K-X-289999	03.97							
	2.0 i	85	6K-X-289999	11.93							
	2.0 i 16V	110	6K-X-289999	07.96			G1020345				20961 17,0 /WD/Acc/S LUC
	1.8 i 16V	95	6K-X-290000		05.99	PR: 1KE,1KK,1KQ	G1020755				20961 17,1 /Acc/S LUC
	1.9 TDI	81	6K-X-290000		05.99	PR: 1KE,1KK,1KQ					
	2.0 i	85	6K-X-290000		05.99	PR: 1KE,1KK,1KQ					
	2.0 i 16V	110	6K-X-290000		05.99	PR: 1KE,1KK,1KQ					
	1.8 i 16V	95	6K-X-289999	02.94			G2110111		without sensor ring <sup>1)</sup>		226 10,0 8,0 +C
	1.9 TDI	81	6K-X-289999	03.97							
	2.0 i	85	6K-X-289999	11.93							
	2.0 i 16V	110	6K-X-289999	07.96							
	1.8 i 16V	95	6K-X-290000		05.99	PR: 1KE,1KK,1KQ	G2109124				232 9,0 7,0 +C
	1.9 TDI	81	6K-X-290000		05.99	PR: 1KE,1KK,1KQ					
	2.0 i	85	6K-X-290000		05.99	PR: 1KE,1KK,1KQ					
	2.0 i 16V	110	6K-X-290000		05.99	PR: 1KE,1KK,1KQ					
SEAT CORDOBA II (6K2) (99-02)											
	1.0	37		06.99	09.02		G1020390				21866 15,3 + VW
	1.4 i	44		06.99	09.02						
	1.4 i 16V			06.99	09.02						
	1.6 i	55		06.99	09.02						
	1.9 SDI			06.99	09.02						
	1.6 i	74		06.99	09.02		G1020444				21945 16,0 /S LUC
	1.9 TDI	66		06.99	09.02						
	1.8 T 20V	115		07.00	09.02		G1020274				20168 19,3 /S LUC
	1.9 TDI	81		06.99	09.02						
	1.0	37		06.99	09.02		G2120123				239 20,0 18,0 V L +S +C
	1.4 i	44		06.99	09.02						
	1.4 i 16V			06.99	09.02						
	1.6 i	55		06.99	09.02						
	1.9 SDI			06.99	09.02						
	1.6 i	74		06.99	09.02		G2120128				256 20,0 18,0 V L +S +C
	1.9 TDI	66		06.99	09.02						
	1.8 T 20V	115		07.00	09.02		G1020755				20961 17,1 /Acc/S LUC
	1.9 TDI	81		06.99	09.02						
	1.8 T 20V	115		07.00	09.02		G2109124				232 9,0 7,0 +C
	1.9 TDI	81		06.99	09.02						
SEAT CORDOBA III (6L2) (02-09)											
	1.2 i	47		10.02	06.09	PR: 1LQ,1ZF	G1020331				23130 19,7 + VW
	1.4 i 16V			10.02	06.09	PR: 1LQ,1ZF					
	1.4 i 16V	74		10.02	06.09	PR: 1LQ,1ZF					
	1.4 TDI			10.02	06.09	PR: 1LQ,1ZF					
	1.6 i 16V			02.03	06.09	PR: 1LQ,1ZF					
	1.9 SDI	47		10.02	06.09	PR: 1LQ,1ZF					
	1.9 TDI	74		10.02	06.09	PR: 1LQ,1ZF					
	1.9 TDI	96		10.02	06.09	PR: 1LQ,1ZF					
	2.0 i 16V	85		10.02	06.09	PR: 1LQ,1ZF					
	1.2 i	47		10.02	06.09	PR: 1LN,1ZH	G1020732				23581 18,8 /S LUC
	1.4 i 16V			10.02	06.09	PR: 1LN,1ZH	G1020733				23843 18,8 +/W/S LUC
	1.4 i 16V	74		10.02	06.09	PR: 1LN,1ZH					
	1.4 TDI			10.02	06.09	PR: 1LN,1ZH					
	1.6 i 16V			02.03	06.09	PR: 1LN,1ZH					
	1.9 SDI	47		10.02	06.09	PR: 1LN,1ZH					
	1.9 TDI	74		10.02	06.09	PR: 1LN,1ZH					
	1.9 TDI	96		10.02	06.09	PR: 1LN,1ZH					

<sup>1)</sup> senza sensori / sans secours ABS / sin anillo sensor ABS / ohne Sensoring



















**SEAT CORDOBA III (6L2) (02-09)**

	2.0 i 16V	85		10.02	06.09	PR: 1LN,1ZH	G1020732 G1020733		23581 18,8 /S 23843 18,8 +/W/S	LUC LUC
	1.2 i 1.4 i 16V 1.4 i 16V 1.4 TDI 1.6 i 16V 1.9 SDI 1.9 TDI 1.9 TDI 2.0 i 16V	47 74 74 96 85		10.02 10.02 10.02 02.03 10.02 10.02 10.02 10.02	06.09 06.09 06.09 06.09 06.09 06.09 06.09 06.09	PR: 1LQ,1ZF PR: 1LQ,1ZF PR: 1LQ,1ZF PR: 1LQ,1ZF PR: 1LQ,1ZF PR: 1LQ,1ZF PR: 1LQ,1ZF PR: 1LQ,1ZF	G2122151		256 22,0 19,0 V L +S +C	
	1.2 i 1.4 i 16V 1.4 i 16V 1.4 TDI 1.6 i 16V 1.9 SDI 1.9 TDI 1.9 TDI 2.0 i 16V	47 74 74 96 85		10.02 10.02 10.02 02.03 10.02 10.02 10.02 10.02	06.09 06.09 06.09 06.09 06.09 06.09 06.09 06.09	PR: 1LN,1ZH PR: 1LN,1ZH PR: 1LN,1ZH PR: 1LN,1ZH PR: 1LN,1ZH PR: 1LN,1ZH PR: 1LN,1ZH PR: 1LN,1ZH	G2125113		288 25,0 22,0 V L +S +C	
	1.2 i 1.4 i 16V 1.4 i 16V 1.4 TDI 1.6 i 16V 1.9 SDI 1.9 TDI 1.9 TDI 2.0 i 16V	47 74 74 96 85		10.02 10.02 10.02 02.03 10.02 10.02 10.02 10.02	06.09 06.09 06.09 06.09 06.09 06.09 06.09 06.09		G1020755 G1020549 G1020566		20961 17,1 /Acc/S 20961 17,1 /WD/S 23554 17,1 +/W/S	LUC LUC LUC
	1.2 i 1.4 i 16V 1.4 i 16V 1.4 TDI 1.6 i 16V 1.9 SDI 1.9 TDI 1.9 TDI 2.0 i 16V	47 74 74 96 85		10.02 10.02 10.02 02.03 10.02 10.02 10.02 10.02	06.09 06.09 06.09 06.09 06.09 06.09 06.09 06.09		G2109123		230 9,0 7,0 +S +C	

**SEAT EXEO / ST (09-13)**

	1.6 1.8 T 1.8 TSI 1.8 TSI 2.0 TDI 2.0 TDI 2.0 TDI 2.0 TFSI	75 110 88 118 88 105 125		04.09 04.09 09.10 05.10 04.09 04.09 04.09 04.09	06.13 06.13 06.13 06.13 06.13 06.13 06.13 06.13	PR: 1LA PR: 1LA PR: 1LA PR: 1LA PR: 1LA PR: 1LA PR: 1LA PR: 1LA	G1020754		23763 20,3 +/W/I	ATE
	1.6 1.8 T 1.8 TSI 1.8 TSI 2.0 TDI 2.0 TDI 2.0 TDI 2.0 TFSI	75 110 88 118 88 105 125		04.09 04.09 09.10 05.10 04.09 04.09 04.09 04.09	06.13 06.13 06.13 06.13 06.13 06.13 06.13 06.13	PR: 1LB,1LT PR: 1LB,1LT PR: 1LB,1LT PR: 1LB,1LT PR: 1LB,1LT PR: 1LB,1LT PR: 1LB,1LT PR: 1LB,1LT	G1020313		23018 20,3 +/W/I	ATE
	1.6 1.8 T 1.8 TSI 1.8 TSI 2.0 TDI 2.0 TDI 2.0 TDI 2.0 TFSI	75 110 88 118 88 105 125		04.09 04.09 09.10 05.10 04.09 04.09 04.09 04.09	06.13 06.13 06.13 06.13 06.13 06.13 06.13 06.13	PR: 1LZ PR: 1LZ PR: 1LZ PR: 1LZ PR: 1LZ PR: 1LZ PR: 1LZ PR: 1LZ	G1020511		21945 19,6 +/W/S	LUC
	1.6 1.8 T 1.8 TSI 1.8 TSI 2.0 TDI 2.0 TDI 2.0 TDI 2.0 TFSI	75 110 88 118 88 105 125		04.09 04.09 09.10 05.10 04.09 04.09 04.09 04.09	06.13 06.13 06.13 06.13 06.13 06.13 06.13 06.13	PR: 1LA PR: 1LA PR: 1LA PR: 1LA PR: 1LA PR: 1LA PR: 1LA PR: 1LA	G2130113		320 30,0 28,0 V L +C	
	1.6 1.8 T 1.8 TSI 1.8 TSI 2.0 TDI 2.0 TDI 2.0 TDI 2.0 TFSI	75 110 88 118 88 105 125		04.09 04.09 09.10 05.10 04.09 04.09 04.09 04.09	06.13 06.13 06.13 06.13 06.13 06.13 06.13 06.13	PR: 1LB PR: 1LB PR: 1LB PR: 1LB PR: 1LB PR: 1LB PR: 1LB PR: 1LB	G2125105		288 25,0 23,0 V L +C	
	1.6 1.8 T 1.8 TSI 1.8 TSI 2.0 TDI	75 110 88 118 88		04.09 04.09 09.10 05.10 04.09	06.13 06.13 06.13 06.13 06.13	PR: 1LT PR: 1LT PR: 1LT PR: 1LT PR: 1LT	G2125137		312 25,0 23,0 V L +C	



									
<b>SEAT EXEO / ST (09-13)</b>									
	2.0 TDI	105		04.09	06.13	PR: 1LT	G2125137	312 25,0 23,0 V L +C	
	2.0 TDI	125		04.09	06.13	PR: 1LT			
	2.0 TFSI			04.09	06.13	PR: 1LT			
		1.6	75		04.09	06.13	PR: 1LZ	G2122152	280 22,0 20,0 V L +C
		1.8 T	110		04.09	06.13	PR: 1LZ		
		1.8 TSI	88		09.10	06.13	PR: 1LZ		
		1.8 TSI	118		05.10	06.13	PR: 1LZ		
		2.0 TDI	88		04.09	06.13	PR: 1LZ		
		2.0 TDI	105		04.09	06.13	PR: 1LZ		
2.0 TDI		125		04.09	06.13	PR: 1LZ			
2.0 TFSI				04.09	06.13	PR: 1LZ			
2.0 TFSI				04.09	06.13	PR: 1LZ			
	1.6	75		04.09	06.13	PR: 1KD,1KP	G1020676	20961 15,8 /S LUC	
	1.8 T	110		04.09	06.13	PR: 1KD,1KP			
	1.8 TSI	88		09.10	06.13	PR: 1KD,1KP			
	1.8 TSI	118		05.10	06.13	PR: 1KD,1KP			
	2.0 TDI	88		04.09	06.13	PR: 1KD,1KP			
	2.0 TDI	105		04.09	06.13	PR: 1KD,1KP			
	2.0 TDI	125		04.09	06.13	PR: 1KD,1KP			
	2.0 TFSI			04.09	06.13	PR: 1KD,1KP			
	2.0 TFSI			04.09	06.13	PR: 1KD,1KP			
	1.6	75		04.09	06.13	PR: 1KW	G1020682	23914 17,1 /WD/Acc/S LUC	
	1.8 T	110		04.09	06.13	PR: 1KW			
	1.8 TSI	88		09.10	06.13	PR: 1KW			
	1.8 TSI	118		05.10	06.13	PR: 1KW			
	2.0 TDI	88		04.09	06.13	PR: 1KW			
	2.0 TDI	105		04.09	06.13	PR: 1KW			
	2.0 TDI	125		04.09	06.13	PR: 1KW			
	2.0 TFSI			04.09	06.13	PR: 1KW			
	2.0 TFSI			04.09	06.13	PR: 1KW			
	1.6	75		04.09	06.13	PR: 1KD	G2110261	245 10,0 8,0 +C	
	1.8 T	110		04.09	06.13	PR: 1KD			
	1.8 TSI	88		09.10	06.13	PR: 1KD			
	1.8 TSI	118		05.10	06.13	PR: 1KD			
	2.0 TDI	88		04.09	06.13	PR: 1KD			
	2.0 TDI	105		04.09	06.13	PR: 1KD			
	2.0 TDI	125		04.09	06.13	PR: 1KD			
	2.0 TFSI			04.09	06.13	PR: 1KD			
	2.0 TFSI			04.09	06.13	PR: 1KD			
<b>SEAT IBIZA I (85-92)</b>									
	0.9			11.86	01.93		G1020141	20775 18,0 /WI BDX	
	1.2			05.85	01.93				
	1.5			05.85	01.93				
	1.5 i			04.88	01.93				
	1.7 D			05.85	01.93				
	1.7 i			01.92	01.93				
<b>SEAT IBIZA II (93-99)</b>									
	1.0 i			02.93	12.96	- ABS	G1020025	20889 17,3 /Acc VW	
	1.3 i			02.93	12.96	- ABS			
	1.4 i			09.93	12.96	- ABS			
	1.0 i				02.93	12.96	+ ABS	G1020009	20887 19,7 +/Acc VW
		1.3 i			02.93	12.96	+ ABS		
		1.4 i			09.93	12.96	+ ABS		
		1.6 i			02.93	12.96			
		1.8 i		6K-ZR003620	02.93				
		1.9 D		6K-ZR003611	02.93				
	1.9 TD		6K-ZR003513	02.93					
	1.8 i		6K-ZR003621		12.96		G1020010 G1020390	20887 15,3 +/Acc VW 21866 15,3 + VW	
	1.9 D		6K-ZR003612		12.96				
	1.9 TD		6K-ZR003514		12.96				
	1.6 i			02.93	12.96		G1020273	20168 16,0 /S LUC	
	1.8 i			02.93	12.96				
1.8 i 16V			02.94	12.96					
2.0 i			02.93	12.96					
2.0 i 16V Cupra 2			07.96	12.96					
1.0 i			01.97	07.99	PR: 1LA	G1020344	20887 17,3 +/Acc VW		
1.3 i			01.97	07.99	PR: 1LA				
1.4 i			01.97	07.99	PR: 1LA				
1.4 i 16V	74		01.97	07.99	PR: 1LA				
1.6 i			01.97	07.99	PR: 1LA				
1.7 SDI			07.97	07.99	PR: 1LA				
1.8 i			01.97	07.99	PR: 1LA				
1.8 i 16V			01.97	07.99	PR: 1LA				
1.9 D			01.97	07.99	PR: 1LA				
1.9 SDI			09.95	07.99	PR: 1LA				
1.9 TD			01.97	07.99	PR: 1LA				
1.9 TDI	66		07.96	07.99	PR: 1LA				
1.9 TDI	81		03.97	07.99	PR: 1LA				
2.0 i			01.97	07.99	PR: 1LA				
2.0 i 16V Cupra 2			01.97	07.99	PR: 1LA				
1.0 i			01.97	07.99	PR: 1LG	G1020390	21866 15,3 + VW		
1.3 i			01.97	07.99	PR: 1LG				
1.4 i			01.97	07.99	PR: 1LG				
1.4 i 16V	74		01.97	07.99	PR: 1LG				
1.6 i			01.97	07.99	PR: 1LG				
1.7 SDI			07.97	07.99	PR: 1LG				
1.8 i			01.97	07.99	PR: 1LG				
1.8 i 16V			01.97	07.99	PR: 1LG				
1.8 i 16V			01.97	07.99	PR: 1LG				



**SEAT IBIZA II (93-99)**

	1.9 D		01.97	07.99	PR: 1LG	G1020390		21866 15,3 +	VW			
	1.9 SDI		09.95	07.99	PR: 1LG							
	1.9 TD		01.97	07.99	PR: 1LG							
	1.9 TDI	66	07.96	07.99	PR: 1LG							
	1.9 TDI	81	03.97	07.99	PR: 1LG							
	2.0 i		01.97	07.99	PR: 1LG							
	2.0 i 16V Cupra 2		01.97	07.99	PR: 1LG							
	1.0 i		01.97	07.99	PR: 1LM					G1020355	21866 19,7 +	VW
	1.3 i		01.97	07.99	PR: 1LM							
	1.4 i		01.97	07.99	PR: 1LM							
1.4 i 16V	74	01.97	07.99	PR: 1LM								
1.6 i		01.97	07.99	PR: 1LM								
1.7 SDI		07.97	07.99	PR: 1LM								
1.8 i		01.97	07.99	PR: 1LM								
1.8 i 16V		01.97	07.99	PR: 1LM								
1.9 D		01.97	07.99	PR: 1LM								
1.9 SDI		09.95	07.99	PR: 1LM								
1.9 TD		01.97	07.99	PR: 1LM								
1.9 TDI	66	07.96	07.99	PR: 1LM								
1.9 TDI	81	03.97	07.99	PR: 1LM								
2.0 i		01.97	07.99	PR: 1LM								
2.0 i 16V Cupra 2		01.97	07.99	PR: 1LM								
1.0 i		01.97	07.99	PR: 1LY,1ZK	G1020444	21945 16,0 /S	LUC					
1.3 i		01.97	07.99	PR: 1LY,1ZK								
1.4 i		01.97	07.99	PR: 1LY,1ZK								
1.4 i 16V	74	01.97	07.99	PR: 1LY,1ZK								
1.6 i		01.97	07.99	PR: 1LY,1ZK								
1.7 SDI		07.97	07.99	PR: 1LY,1ZK								
1.8 i		01.97	07.99	PR: 1LY,1ZK								
1.8 i 16V		01.97	07.99	PR: 1LY,1ZK								
1.9 D		01.97	07.99	PR: 1LY,1ZK								
1.9 SDI		09.95	07.99	PR: 1LY,1ZK								
1.9 TD		01.97	07.99	PR: 1LY,1ZK								
1.9 TDI	66	07.96	07.99	PR: 1LY,1ZK								
1.9 TDI	81	03.97	07.99	PR: 1LY,1ZK								
2.0 i		01.97	07.99	PR: 1LY,1ZK								
2.0 i 16V Cupra 2		01.97	07.99	PR: 1LY,1ZK								
1.0 i		01.97	07.99	PR: 1LD,1LV,1LW	G1020274	20168 19,3 /S	LUC					
1.3 i		01.97	07.99	PR: 1LD,1LV,1LW								
1.4 i		01.97	07.99	PR: 1LD,1LV,1LW								
1.4 i 16V	74	01.97	07.99	PR: 1LD,1LV,1LW								
1.6 i		01.97	07.99	PR: 1LD,1LV,1LW								
1.7 SDI		07.97	07.99	PR: 1LD,1LV,1LW								
1.8 i		01.97	07.99	PR: 1LD,1LV,1LW								
1.8 i 16V		01.97	07.99	PR: 1LD,1LV,1LW								
1.9 D		01.97	07.99	PR: 1LD,1LV,1LW								
1.9 SDI		09.95	07.99	PR: 1LD,1LV,1LW								
1.9 TD		01.97	07.99	PR: 1LD,1LV,1LW								
1.9 TDI	66	07.96	07.99	PR: 1LD,1LV,1LW								
1.9 TDI	81	03.97	07.99	PR: 1LD,1LV,1LW								
2.0 i		01.97	07.99	PR: 1LD,1LV,1LW								
2.0 i 16V Cupra 2		01.97	07.99	PR: 1LD,1LV,1LW								
	1.0 i		02.93	07.99	PR: 1LA	G2110151		239 10,0 8,0 +S +C				
	1.3 i		02.93	07.99	PR: 1LA							
	1.4 i		09.93	07.99	PR: 1LA							
	1.4 i 16V	74	09.96	07.99	PR: 1LA							
	1.6 i		02.93	07.99	PR: 1LA							
	1.7 SDI		07.97	07.99	PR: 1LA							
	1.8 i		02.93	07.99	PR: 1LA							
	1.8 i 16V		02.94	07.99	PR: 1LA							
	1.9 D		02.93	07.99	PR: 1LA							
	1.9 SDI		09.95	07.99	PR: 1LA							
1.9 TD		02.93	07.99	PR: 1LA								
1.9 TDI	66	07.96	07.99	PR: 1LA								
1.9 TDI	81	03.97	07.99	PR: 1LA								
2.0 i		02.93	07.99	PR: 1LA								
2.0 i 16V Cupra 2		07.96	07.99	PR: 1LA								
1.0 i		02.93	07.99	PR: 1LG	G2120123		239 20,0 18,0 V L +S +C					
1.3 i		02.93	07.99	PR: 1LG								
1.4 i		09.93	07.99	PR: 1LG								
1.4 i 16V	74	09.96	07.99	PR: 1LG								
1.6 i		02.93	07.99	PR: 1LG								
1.7 SDI		07.97	07.99	PR: 1LG								
1.8 i		02.93	07.99	PR: 1LG								
1.8 i 16V		02.94	07.99	PR: 1LG								
1.9 D		02.93	07.99	PR: 1LG								
1.9 SDI		09.95	07.99	PR: 1LG								
1.9 TD		02.93	07.99	PR: 1LG								
1.9 TDI	66	07.96	07.99	PR: 1LG								
1.9 TDI	81	03.97	07.99	PR: 1LG								
2.0 i		02.93	07.99	PR: 1LG								
2.0 i 16V Cupra 2		07.96	07.99	PR: 1LG								
1.0 i		01.97	07.99	PR: 1LM	G2120123		239 20,0 18,0 V L +S +C					
1.3 i		01.97	07.99	PR: 1LM								
1.4 i		01.97	07.99	PR: 1LM								
1.4 i 16V	74	01.97	07.99	PR: 1LM								
1.6 i		01.97	07.99	PR: 1LM								







**SEAT IBIZA II (93-99)**

	1.7 SDI		07.97	07.99	PR: 1LM	G2120123		239 20,0 18,0 V L +S +C					
	1.8 i		01.97	07.99	PR: 1LM								
	1.8 i 16V		01.97	07.99	PR: 1LM								
	1.9 D		01.97	07.99	PR: 1LM								
	1.9 SDI		09.95	07.99	PR: 1LM								
	1.9 TD		01.97	07.99	PR: 1LM								
	1.9 TDI	66	07.96	07.99	PR: 1LM								
	1.9 TDI	81	03.97	07.99	PR: 1LM								
	2.0 i		01.97	07.99	PR: 1LM								
	2.0 i 16V Cupra 2		01.97	07.99	PR: 1LM								
	1.0 i		01.97	07.99	PR: 1LY,1ZK	G2120128		256 20,0 18,0 V L +S +C					
	1.3 i		01.97	07.99	PR: 1LY,1ZK								
	1.4 i		01.97	07.99	PR: 1LY,1ZK								
	1.4 i 16V	74	01.97	07.99	PR: 1LY,1ZK								
	1.6 i		01.97	07.99	PR: 1LY,1ZK								
	1.7 SDI		07.97	07.99	PR: 1LY,1ZK								
	1.8 i		01.97	07.99	PR: 1LY,1ZK								
	1.8 i 16V		01.97	07.99	PR: 1LY,1ZK								
	1.9 D		01.97	07.99	PR: 1LY,1ZK								
	1.9 SDI		09.95	07.99	PR: 1LY,1ZK								
1.9 TD		01.97	07.99	PR: 1LY,1ZK									
1.9 TDI	66	07.96	07.99	PR: 1LY,1ZK									
1.9 TDI	81	03.97	07.99	PR: 1LY,1ZK									
2.0 i		01.97	07.99	PR: 1LY,1ZK									
2.0 i 16V Cupra 2		01.97	07.99	PR: 1LY,1ZK									
	1.8 i 16V		02.94	07.99		G1020201		20961 15,2 /WD/Acc/S	LUC				
	1.9 TDI	81	03.97	07.99									
	2.0 i		02.93	07.99									
	2.0 i 16V Cupra 2		07.96	07.99									
	1.0 i		02.93	07.99	PR: 1KK					G1020345		20961 17,0 /WD/Acc/S	LUC
	1.3 i		02.93	07.99	PR: 1KK								
	1.4 i		09.93	07.99	PR: 1KK								
	1.4 i 16V	74	09.96	07.99	PR: 1KK								
	1.6 i		02.93	07.99	PR: 1KK								
	1.7 SDI		07.97	07.99	PR: 1KK								
1.8 i		02.93	07.99	PR: 1KK									
1.8 i 16V		02.94	07.99	PR: 1KK									
1.9 D		02.93	07.99	PR: 1KK									
1.9 SDI		09.95	07.99	PR: 1KK									
1.9 TD		02.93	07.99	PR: 1KK									
1.9 TDI	66	07.96	07.99	PR: 1KK									
1.9 TDI	81	03.97	07.99	PR: 1KK									
2.0 i		02.93	07.99	PR: 1KK									
2.0 i 16V Cupra 2		07.96	07.99	PR: 1KK									
	1.8 i 16V		02.94	07.99		G2110111	without sensor ring <sup>1)</sup>	226 10,0 8,0 +C					
	1.9 TDI	81	03.97	07.99									
	2.0 i		02.93	07.99									
	1.0 i		02.93	07.99	PR: 1KK					G2109124		232 9,0 7,0 +C	
	1.3 i		02.93	07.99	PR: 1KK								
	1.4 i		09.93	07.99	PR: 1KK								
	1.4 i 16V	74	09.96	07.99	PR: 1KK								
	1.6 i		02.93	07.99	PR: 1KK								
	1.7 SDI		07.97	07.99	PR: 1KK								
	1.8 i		02.93	07.99	PR: 1KK								
1.8 i 16V		02.94	07.99	PR: 1KK									
1.9 D		02.93	07.99	PR: 1KK									
1.9 SDI		09.95	07.99	PR: 1KK									
1.9 TD		02.93	07.99	PR: 1KK									
1.9 TDI	66	07.96	07.99	PR: 1KK									
1.9 TDI	81	03.97	07.99	PR: 1KK									
2.0 i		02.93	07.99	PR: 1KK									
2.0 i 16V Cupra 2		07.96	07.99	PR: 1KK									

**SEAT IBIZA III (6K1) (99-02)**

	1.0 i		08.99	01.02	PR: 1LG	G1020390		21866 15,3 +	VW				
	1.4 i	44	08.99	01.02	PR: 1LG								
	1.4 i 16V		08.99	01.02	PR: 1LG								
	1.6 i		08.99	01.02	PR: 1LG								
	1.8 T 20V	115	07.00	01.02	PR: 1LG								
	1.9 SDI		08.99	01.02	PR: 1LG								
	1.9 TDI	66	08.99	01.02	PR: 1LG								
	1.9 TDI	81	08.99	01.02	PR: 1LG								
	1.0 i		08.99	01.02	PR: 1ZK					G1020444		21945 16,0 /S	LUC
	1.4 i	44	08.99	01.02	PR: 1LM,1ZK								
1.4 i 16V		08.99	01.02	PR: 1ZK									
1.6 i		08.99	01.02	PR: 1ZK									
1.8 T 20V	115	07.00	01.02	PR: 1ZK									
1.9 SDI		08.99	01.02	PR: 1LM,1ZK									
1.9 TDI	66	08.99	01.02	PR: 1ZK									
1.9 TDI	81	08.99	01.02	PR: 1ZK									
1.0 i		08.99	01.02	PR: 1LV,1LW	G1020274		20168 19,3 /S	LUC					
1.4 i	44	08.99	01.02	PR: 1LV,1LW									
1.4 i 16V		08.99	01.02	PR: 1LV,1LW									
1.6 i		08.99	01.02	PR: 1LV,1LW									
1.8 T 20V	115	07.00	01.02	PR: 1LV,1LW									
1.9 SDI		08.99	01.02	PR: 1LV,1LW									
1.9 SDI		08.99	01.02	PR: 1LV,1LW									

<sup>1)</sup> senza sensori / sans secours ABS / sin anillo sensor ABS / ohne Sensoring



### SEAT IBIZA III (6K1) (99-02)

	1.9 TDI	66		08.99	01.02	PR: 1LV,1LW	G1020274		20168 19,3 /S	LUC					
	1.9 TDI	81		08.99	01.02	PR: 1LV,1LW									
	1.0 i	44	6K-W-000 500	08.99		PR: 1LA	G1020344		20887 17,3 +/-Acc	VW					
	1.4 i		6K-W-000 500	08.99		PR: 1LA									
	1.4 i 16V		6K-W-000 500	08.99		PR: 1LA									
	1.6 i		6K-W-000 500	08.99		PR: 1LA									
	1.8 T 20V		6K-W-000 500	07.00		PR: 1LA									
	1.9 SDI		6K-W-000 500	08.99		PR: 1LA									
	1.9 TDI		66	6K-W-000 500	08.99						PR: 1LA				
	1.9 TDI		81	6K-W-000 500	08.99						PR: 1LA				
	1.4 i		44		08.99	01.02					PR: 1LM	G2112106		239 12,0 10,0 +S +C	
	1.9 SDI				08.99	01.02					PR: 1LM				
	1.0 i	44		08.99	01.02	PR: 1LG	G2120123		239 20,0 18,0 V L +S +C						
	1.4 i			08.99	01.02	PR: 1LG									
	1.4 i 16V			08.99	01.02	PR: 1LG									
	1.6 i			08.99	01.02	PR: 1LG									
	1.8 T 20V		115		07.00	01.02					PR: 1LG				
	1.9 SDI				08.99	01.02					PR: 1LG				
	1.9 TDI		66		08.99	01.02					PR: 1LG				
	1.9 TDI		81		08.99	01.02					PR: 1LG				
	1.0 i		44		08.99	01.02					PR: 1ZK	G2120128		256 20,0 18,0 V L +S +C	
	1.4 i				08.99	01.02					PR: 1ZK				
1.4 i 16V		08.99		01.02	PR: 1ZK										
1.6 i		08.99		01.02	PR: 1ZK										
1.8 T 20V	115			07.00	01.02	PR: 1ZK									
1.9 SDI				08.99	01.02	PR: 1ZK									
1.9 TDI	66			08.99	01.02	PR: 1ZK									
1.9 TDI	81			08.99	01.02	PR: 1ZK									
1.0 i	44	6K-W-000 500		08.99		PR: 1LA	G2110151	- ABS	239 10,0 8,0 +S +C						
1.4 i		6K-W-000 500		08.99		PR: 1LA									
1.4 i 16V		6K-W-000 500	08.99		PR: 1LA										
1.6 i		6K-W-000 500	08.99		PR: 1LA										
1.8 T 20V		115	6K-W-000 500	07.00		PR: 1LA									
1.9 SDI			6K-W-000 500	08.99		PR: 1LA									
1.9 TDI		66	6K-W-000 500	08.99		PR: 1LA									
1.9 TDI		81	6K-W-000 500	08.99		PR: 1LA									
1.0 i		44		08.99	01.02	PR: 1KE,1KK,1KQ					G1020755		20961 17,1 /Acc/S	LUC	
1.4 i				08.99	01.02	PR: 1KE,1KK,1KQ									
1.4 i 16V			08.99	01.02	PR: 1KE,1KK,1KQ										
1.6 i			08.99	01.02	PR: 1KE,1KK,1KQ										
1.8 i Cupra R	132			04.01	01.02	PR: 1KE,1KK,1KQ									
1.8 T 20V	115			07.00	01.02	PR: 1KE,1KK,1KQ									
1.9 SDI				08.99	01.02	PR: 1KE,1KK,1KQ									
1.9 TDI	66			08.99	01.02	PR: 1KE,1KK,1KQ									
1.9 TDI	81			08.99	01.02	PR: 1KE,1KK,1KQ									
	1.0 i		44		08.99	01.02	PR: 1KE,1KK,1KQ	G2109124		232 9,0 7,0 +C					
	1.4 i			08.99	01.02	PR: 1KE,1KK,1KQ									
	1.4 i 16V			08.99	01.02	PR: 1KE,1KK,1KQ									
	1.6 i			08.99	01.02	PR: 1KE,1KK,1KQ									
	1.8 i Cupra R	132			04.01	01.02	PR: 1KE,1KK,1KQ								
	1.8 T 20V	115			07.00	01.02	PR: 1KE,1KK,1KQ								
	1.9 SDI				08.99	01.02	PR: 1KE,1KK,1KQ								
	1.9 TDI	66			08.99	01.02	PR: 1KE,1KK,1KQ								
	1.9 TDI	81			08.99	01.02	PR: 1KE,1KK,1KQ								

### SEAT IBIZA IV (6L1) (02-10)

	1.2	44		06.07	05.08	PR: 1LQ,1ZF	G1020331		23130 19,7 +	VW
	1.2 i	47		02.02	02.10	PR: 1LQ,1ZF				
	1.2 i 12V	51		05.06	02.10	PR: 1LQ,1ZF	G1020732 G1020733		23581 18,8 /S 23843 18,8 +/-W/S	LUC LUC
	1.4 i 16V	55		02.02	02.10	PR: 1LQ,1ZF				
	1.4 i 16V	63		05.06	02.10	PR: 1LQ,1ZF				
	1.4 i 16V	74		02.02	02.10	PR: 1LQ,1ZF				
	1.4 TDI	51		05.05	02.10	PR: 1LQ,1ZF				
	1.4 TDI	55		02.02	02.10	PR: 1LQ,1ZF				
	1.4 TDI	59		05.05	02.10	PR: 1LQ,1ZF				
	1.6 i 16V			02.03	02.10	PR: 1LQ,1ZF				
	1.8 T FR	110		12.03	02.10	PR: 1LQ,1ZF				
	1.9 SDI	47		02.02	02.10	PR: 1LQ,1ZF				
	1.9 TDI	74		02.02	02.10	PR: 1LQ,1ZF				
	1.9 TDI	96		02.02	02.10	PR: 1LQ,1ZF				
	1.9 TDI Cupra R	110		01.04	02.10	PR: 1LQ,1ZF				
	1.9 TDI Cupra R	118		03.04	02.08	PR: 1LQ,1ZF				
	2.0	85		04.02	02.10	PR: 1LQ,1ZF				
	1.2	44		06.07	05.08	PR: 1LN,1ZH				
	1.2 i	47		02.02	02.10	PR: 1LN,1ZH				
	1.2 i 12V	51		05.06	02.10	PR: 1LN,1ZH				
	1.4 i 16V	55		02.02	02.10	PR: 1LN,1ZH				
	1.4 i 16V	63		05.06	02.10	PR: 1LN,1ZH				
1.4 i 16V	74		02.02	02.10	PR: 1LN,1ZH					
1.4 TDI	51		05.05	02.10	PR: 1LN,1ZH					
1.4 TDI	55		02.02	02.10	PR: 1LN,1ZH					
1.4 TDI	59		05.05	02.10	PR: 1LN,1ZH					
1.6 i 16V			02.03	02.10	PR: 1LN,1ZH					
1.8 T FR	110		12.03	02.10	PR: 1LN,1ZH					
1.9 SDI	47		02.02	02.10	PR: 1LN,1ZH					
1.9 TDI	74		02.02	02.10	PR: 1LN,1ZH					



SEAT IBIZA IV (6L1) (02-10)										
	1.9 TDI	96		02.02	02.10	PR: 1LN,1ZH	G1020732 G1020733		23581 18,8 /S 23843 18,8 +/W/S	LUC LUC
	1.9 TDI Cupra R	110		01.04	02.10	PR: 1LN,1ZH				
	1.9 TDI Cupra R	118		03.04	02.08	PR: 1LN,1ZH				
	2.0	85		04.02	02.10	PR: 1LN,1ZH				
1.8 T Cupra R	132		01.04	02.10		G1020379		21911 20,3 +	ATE	
	1.2	44		06.07	05.08	PR: 1LQ,1ZF	G2122151		256 22,0 19,0 V L +S +C	
	1.2 i	47		02.02	02.10	PR: 1LQ,1ZF				
	1.2 i 12V	51		05.06	02.10	PR: 1LQ,1ZF				
	1.4 i 16V	55		02.02	02.10	PR: 1LQ,1ZF				
	1.4 i 16V	63		05.06	02.10	PR: 1LQ,1ZF				
	1.4 i 16V	74		02.02	02.10	PR: 1LQ,1ZF				
	1.4 TDI	51		05.05	02.10	PR: 1LQ,1ZF				
	1.4 TDI	55		02.02	02.10	PR: 1LQ,1ZF				
	1.4 TDI	59		05.05	02.10	PR: 1LQ,1ZF				
	1.6 i 16V			02.03	02.10	PR: 1LQ,1ZF				
	1.8 T FR	110		12.03	02.10	PR: 1LQ,1ZF				
	1.9 SDI	47		02.02	02.10	PR: 1LQ,1ZF				
	1.9 TDI	74		02.02	02.10	PR: 1LQ,1ZF				
	1.9 TDI	96		02.02	02.10	PR: 1LQ,1ZF				
	1.9 TDI Cupra R	110		01.04	02.10	PR: 1LQ,1ZF				
	1.9 TDI Cupra R	118		03.04	02.08	PR: 1LQ,1ZF				
	2.0	85		04.02	02.10	PR: 1LQ,1ZF				
1.8 T Cupra R	132		01.04	02.10		G2125113		288 25,0 22,0 V L +S +C		
	1.2	44		06.07	05.08	PR: 1LN,1ZH	G1020755 G1020549 G1020566		20961 17,1 /Acc/S 20961 17,1 /WD/S 23554 17,1 +/W/S	LUC LUC LUC
	1.2 i	47		02.02	02.10					
	1.2 i 12V	51		05.06	02.10					
	1.4 i 16V	55		02.02	02.10					
	1.4 i 16V	63		05.06	02.10					
	1.4 i 16V	74		02.02	02.10					
	1.4 TDI	51		05.05	02.10					
	1.4 TDI	55		02.02	02.10					
	1.4 TDI	59		05.05	02.10					
	1.6 i 16V			02.03	02.10					
	1.8 T Cupra R	132		01.04	02.10					
	1.8 T FR	110		12.03	02.10					
	1.9 SDI	47		02.02	02.10					
	1.9 TDI	74		02.02	02.10					
	1.9 TDI	96		02.02	02.10					
	1.9 TDI Cupra R	110		01.04	02.10					
	1.9 TDI Cupra R	118		03.04	02.08					
2.0	85		04.02	02.10						
	1.2	44		06.07	05.08		G2109123		230 9,0 7,0 +S +C	
	1.2 i	47		02.02	02.10					
	1.2 i 12V	51		05.06	02.10					
	1.4 i 16V	55		02.02	02.10					
	1.4 i 16V	63		05.06	02.10					
	1.4 i 16V	74		02.02	02.10					
	1.4 TDI	51		05.05	02.10					
	1.4 TDI	55		02.02	02.10					
	1.4 TDI	59		05.05	02.10					
	1.6 i 16V			02.03	02.10					
	1.8 T Cupra R	132		01.04	02.10					
	1.8 T FR	110		12.03	02.10					
	1.9 SDI	47		02.02	02.10					
	1.9 TDI	74		02.02	02.10					
	1.9 TDI	96		02.02	02.10					
	1.9 TDI Cupra R	110		01.04	02.10					
	1.9 TDI Cupra R	118		03.04	02.08					
2.0	85		04.02	02.10						

SEAT IBIZA V / ST / SPORTCOUPE (08-)										
	1.2	44		07.09		PR: 1LQ,1LR,1ZG	G1020331		23130 19,7 +	VW
	1.2	51		07.08		PR: 1LQ,1LR,1ZG				
	1.2 TDI	55		04.10		PR: 1LQ,1LR,1ZG				
	1.2 TSI	63		08.12		PR: 1LQ,1LR,1ZG				
	1.2 TSI	77		09.10		PR: 1LQ,1LR,1ZG				
	1.4 i 16V	63		07.08		PR: 1LQ,1LR,1ZG				
	1.4 TDI	59		07.08		PR: 1LQ,1LR,1ZG				
	1.4 TSI FR	110		06.09		PR: 1LQ,1LR,1ZG				
1.6 i 16V	77		07.08		PR: 1LQ,1LR,1ZG					





**SEAT IBIZA V / ST / SPORTCOUPE (08-)**

	1.6 LPG	60		05.11	PR: 1LQ,1LR,1ZG	G1020331		23130 19,7 +	VW				
	1.6 TDI	66		06.09	PR: 1LQ,1LR,1ZG								
	1.6 TDI	77		06.09	PR: 1LQ,1LR,1ZG								
	1.9 TDI	66		07.08	PR: 1LQ,1LR,1ZG								
	1.9 TDI	77		07.08	PR: 1LQ,1LR,1ZG								
	2.0	85		10.08	PR: 1LQ,1LR,1ZG								
	2.0 TDI	105		01.10	PR: 1LQ,1LR,1ZG								
	1.2	44		07.09	PR: 1LN,1ZH					G1020680		23587 20,6 +/Wl	ATE
	1.2	51		07.08	PR: 1LN,1ZH								
	1.2 TDI	55		04.10	PR: 1LN,1ZH								
	1.2 TSI	63		08.12	PR: 1LN,1ZH								
	1.2 TSI	77		09.10	PR: 1LN,1ZH								
	1.4 i 16V	63		07.08	PR: 1LN,1ZH								
	1.4 TDI	59		07.08	PR: 1LN,1ZH								
	1.4 TSI FR	110		06.09	PR: 1LN,1ZH								
	1.6 i 16V	77		07.08	PR: 1LN,1ZH								
	1.6 LPG	60		05.11	PR: 1LN,1ZH								
	1.6 TDI	66		06.09	PR: 1LN,1ZH								
	1.6 TDI	77		06.09	PR: 1LN,1ZH								
	1.9 TDI	66		07.08	PR: 1LN,1ZH								
1.9 TDI	77		07.08	PR: 1LN,1ZH									
2.0	85		10.08	PR: 1LN,1ZH									
2.0 TDI	105		01.10	PR: 1LN,1ZH									
	1.2	44		07.09	PR: 1LQ,1LR,1ZG	G2122151		256 22,0 19,0 V L +S +C					
	1.2	51		07.08	PR: 1LQ,1LR,1ZG								
	1.2 TDI	55		04.10	PR: 1LQ,1LR,1ZG								
	1.2 TSI	63		08.12	PR: 1LQ,1LR,1ZG								
	1.2 TSI	77		09.10	PR: 1LQ,1LR,1ZG								
	1.4 i 16V	63		07.08	PR: 1LQ,1LR,1ZG								
	1.4 TDI	59		07.08	PR: 1LQ,1LR,1ZG								
	1.4 TSI FR	110		06.09	PR: 1LQ,1LR,1ZG								
	1.6 i 16V	77		07.08	PR: 1LQ,1LR,1ZG								
	1.6 LPG	60		05.11	PR: 1LQ,1LR,1ZG								
	1.6 TDI	66		06.09	PR: 1LQ,1LR,1ZG								
	1.6 TDI	77		06.09	PR: 1LQ,1LR,1ZG								
	1.9 TDI	66		07.08	PR: 1LQ,1LR,1ZG								
	1.9 TDI	77		07.08	PR: 1LQ,1LR,1ZG								
	2.0	85		10.08	PR: 1LQ,1LR,1ZG								
	2.0 TDI	105		01.10	PR: 1LQ,1LR,1ZG								
	1.2	44		07.09	PR: 1LN,1ZH					G2125113		288 25,0 22,0 V L +S +C	
	1.2	51		07.08	PR: 1LN,1ZH								
	1.2 TDI	55		04.10	PR: 1LN,1ZH								
	1.2 TSI	63		08.12	PR: 1LN,1ZH								
1.2 TSI	77		09.10	PR: 1LN,1ZH									
1.4 i 16V	63		07.08	PR: 1LN,1ZH									
1.4 TDI	59		07.08	PR: 1LN,1ZH									
1.4 TSI FR	110		06.09	PR: 1LN,1ZH									
1.6 i 16V	77		07.08	PR: 1LN,1ZH									
1.6 LPG	60		05.11	PR: 1LN,1ZH									
1.6 TDI	66		06.09	PR: 1LN,1ZH									
1.6 TDI	77		06.09	PR: 1LN,1ZH									
1.9 TDI	66		07.08	PR: 1LN,1ZH									
1.9 TDI	77		07.08	PR: 1LN,1ZH									
2.0	85		10.08	PR: 1LN,1ZH									
2.0 TDI	105		01.10	PR: 1LN,1ZH									
1.4 TSI Cupra	132		06.09	PR: 1LV	G2125123		310 25,0 22,0 V L +C						
	1.2	44		07.09	PR: 1KK,1KT	G1020755		20961 17,1 /Acc/S	LUC				
	1.2	51		07.08	PR: 1KK,1KT								
	1.2 TDI	55		04.10	PR: 1KK,1KT								
	1.2 TSI	63		08.12	PR: 1KK,1KT								
	1.2 TSI	77		09.10	PR: 1KK,1KT								
	1.4 i 16V	63		07.08	PR: 1KK,1KT								
	1.4 TDI	59		07.08	PR: 1KK,1KT								
	1.4 TSI Cupra	132		06.09	PR: 1KK,1KT								
	1.4 TSI FR	110		06.09	PR: 1KK,1KT								
	1.6 i 16V	77		07.08	PR: 1KK,1KT								
	1.6 LPG	60		05.11	PR: 1KK,1KT								
	1.6 TDI	66		06.09	PR: 1KK,1KT								
	1.6 TDI	77		06.09	PR: 1KK,1KT								
	1.9 TDI	66		07.08	PR: 1KK,1KT								
1.9 TDI	77		07.08	PR: 1KK,1KT									
2.0	85		10.08	PR: 1KK,1KT									
2.0 TDI	105		01.10	PR: 1KK,1KT									
1.4 TSI FR	110		06.09	PR: 1KD,1KS	G1020549		20961 17,1 /WD/S	LUC					
1.4 TSI Cupra	132		06.09	PR: 1KP	G1020492		23554 17,1 /WD/S	LUC					
	1.2	44		07.09	PR: 1KK,1KT	G2109123		230 9,0 7,0 +S +C					
	1.2	51		07.08	PR: 1KK,1KT								
	1.2 TDI	55		04.10	PR: 1KK,1KT								
	1.2 TSI	63		08.12	PR: 1KK,1KT								
	1.2 TSI	77		09.10	PR: 1KK,1KT								
	1.4 i 16V	63		07.08	PR: 1KK,1KT								
	1.4 TDI	59		07.08	PR: 1KK,1KT								
	1.4 TSI Cupra	132		06.09	PR: 1KP								
	1.4 TSI FR	110		06.09	PR: 1KD,1KS								
	1.6 i 16V	77		07.08	PR: 1KK,1KT								
1.6 LPG	60		05.11	PR: 1KK,1KT									





**SEAT IBIZA V / ST / SPORTCOUPE (08-)**













	1.6 TDI	66		<b>06.09</b>	PR: 1KK,1KT	<b>G2109123</b>		230 9,0 7,0 +S +C
	1.6 TDI	77		<b>06.09</b>	PR: 1KK,1KT			
	1.9 TDI	66		<b>07.08</b>	PR: 1KK,1KT			
	1.9 TDI	77		<b>07.08</b>	PR: 1KK,1KT			
	2.0	85		<b>07.08</b>	PR: 1KK,1KT			
	2.0 TDI	105		<b>01.10</b>	PR: 1KK,1KT			

**SEAT INCA (6K9) (96-03)**

	1.4 i	44	9K-T-011100	<b>11.95</b>		<b>G1020274</b>		20168 19,3 /S	<b>LUC</b>
	1.4 i 16V	55		<b>04.00</b>	<b>08.03</b>				
	1.6 i	55	9K-T-011100	<b>11.95</b>					
	1.9 D	47	9K-T-011100	<b>11.95</b>					
	1.9 SDI / TDI	47	9K-T-011100	<b>11.95</b>					
	1.4 i	44	9K-T-011101		<b>08.03</b>	<b>G1020444</b>		21945 16,0 /S	<b>LUC</b>
	1.4 i 16V	55		<b>04.00</b>	<b>08.03</b>				
	1.6 i	55	9K-T-011101		<b>08.03</b>				
	1.7 SDI	42		<b>09.96</b>	<b>08.03</b>				
	1.9 D	47	9K-T-011101		<b>08.03</b>				
	1.9 SDI / TDI	47	9K-T-011101		<b>08.03</b>				
	1.4 i	44	9K-T-011100	<b>11.95</b>		<b>G2113178</b>		256 12,9 11,0 +S +C	
	1.4 i 16V	55		<b>04.00</b>	<b>08.03</b>				
	1.6 i	55	9K-T-011100	<b>11.95</b>					
	1.9 D	47	9K-T-011100	<b>11.95</b>					
	1.9 SDI / TDI	47	9K-T-011100	<b>11.95</b>					
	1.4 i	44	9K-T-011101		<b>08.03</b>	<b>G2120128</b>		256 20,0 18,0 V L +S +C	
	1.6 i	55	9K-T-011101		<b>08.03</b>				
	1.7 SDI	42		<b>09.96</b>	<b>08.03</b>				
	1.9 D	47	9K-T-011101		<b>08.03</b>				
	1.9 SDI / TDI	47	9K-T-011101		<b>08.03</b>				

**SEAT LEON I (1M1) (99-05)**

	1.4 i 16V			<b>11.99</b>	<b>07.05</b>	PR: 1LQ	<b>G1020331</b>		23130 19,7 +	<b>VW</b>				
	1.6 i 16V			<b>11.99</b>	<b>07.05</b>	PR: 1LQ								
	1.8 20V T	132		<b>11.99</b>	<b>07.05</b>	PR: 1LQ								
	1.8 20V T 4x4	132		<b>11.99</b>	<b>07.05</b>	PR: 1LQ								
	1.8 i 20V	92		<b>11.99</b>	<b>07.05</b>	PR: 1LQ								
	1.8 T 4x4	154		<b>05.02</b>	<b>07.05</b>	PR: 1LQ								
	1.9 SDI	50		<b>11.99</b>	<b>07.05</b>	PR: 1LQ								
	1.9 TDI			<b>11.99</b>	<b>07.05</b>	PR: 1LQ								
	1.9 TDI			<b>11.99</b>	<b>07.05</b>	PR: 1LQ								
	1.9 TDI	96		<b>05.03</b>	<b>07.05</b>	PR: 1LQ								
	1.9 TDI	110		<b>02.01</b>	<b>07.05</b>	PR: 1LQ								
	1.9 TDI Syncro	110		<b>05.02</b>	<b>07.05</b>	PR: 1LQ								
	2.3 VR5	110		<b>09.00</b>	<b>07.05</b>	PR: 1LQ								
	2.8	150		<b>05.02</b>	<b>07.05</b>	PR: 1LQ								
	1.4 i 16V			<b>11.99</b>	<b>07.05</b>	PR: 1LS					<b>G1020463</b>		23131 19,7 +/Wl	<b>VW</b>
	1.6 i 16V			<b>11.99</b>	<b>07.05</b>	PR: 1LS								
1.8 20V T	132		<b>11.99</b>	<b>07.05</b>	PR: 1LS									
1.8 20V T 4x4	132		<b>11.99</b>	<b>07.05</b>	PR: 1LS									
1.8 i 20V	92		<b>11.99</b>	<b>07.05</b>	PR: 1LS									
1.8 T 4x4	154		<b>05.02</b>	<b>07.05</b>	PR: 1LS									
1.9 SDI	50		<b>11.99</b>	<b>07.05</b>	PR: 1LS									
1.9 TDI			<b>11.99</b>	<b>07.05</b>	PR: 1LS									
1.9 TDI			<b>11.99</b>	<b>07.05</b>	PR: 1LS									
1.9 TDI	96		<b>05.03</b>	<b>07.05</b>	PR: 1LS									
1.9 TDI	110		<b>02.01</b>	<b>07.05</b>	PR: 1LS									
1.9 TDI Syncro	110		<b>05.02</b>	<b>07.05</b>	PR: 1LS									
2.3 VR5	110		<b>09.00</b>	<b>07.05</b>	PR: 1LS									
2.8	150		<b>05.02</b>	<b>07.05</b>	PR: 1LS									
1.4 i 16V			<b>11.99</b>	<b>07.05</b>	PR: 1LE	<b>G1020379</b>		21911 20,3 +	<b>ATE</b>					
1.6 i 16V			<b>11.99</b>	<b>07.05</b>	PR: 1LE									
1.8 20V T	132		<b>11.99</b>	<b>07.05</b>	PR: 1LE									
1.8 20V T 4x4	132		<b>11.99</b>	<b>07.05</b>	PR: 1LE									
1.8 i 20V	92		<b>11.99</b>	<b>07.05</b>	PR: 1LE									
1.9 SDI	50		<b>11.99</b>	<b>07.05</b>	PR: 1LE									
1.9 TDI			<b>11.99</b>	<b>07.05</b>	PR: 1LE									
1.9 TDI			<b>11.99</b>	<b>07.05</b>	PR: 1LE									
1.9 TDI	96		<b>05.03</b>	<b>07.05</b>	PR: 1LE									
1.9 TDI	110		<b>02.01</b>	<b>07.05</b>	PR: 1LE									
1.9 TDI Syncro	110		<b>05.02</b>	<b>07.05</b>	PR: 1LE									
2.3 VR5	110		<b>09.00</b>	<b>07.05</b>	PR: 1LE									
2.8	150		<b>05.02</b>	<b>07.05</b>	PR: 1LE									
1.4 i 16V			<b>11.99</b>	<b>07.05</b>	PR: 1LJ,1ZQ					<b>G1020512</b>		23392 20,3 +/Wl	<b>ATE</b>	
1.6 i 16V			<b>11.99</b>	<b>07.05</b>	PR: 1LJ,1ZQ									
1.8 20V T	132		<b>11.99</b>	<b>07.05</b>	PR: 1LJ,1ZQ									
1.8 20V T 4x4	132		<b>11.99</b>	<b>07.05</b>	PR: 1LJ,1ZQ									
1.8 i 20V	92		<b>11.99</b>	<b>07.05</b>	PR: 1LJ,1ZQ									
1.8 T Cupra R	154		<b>05.02</b>	<b>07.05</b>	PR: 1LT									
1.8 T Cupra R	165		<b>07.03</b>	<b>07.05</b>	PR: 1LT									
1.9 SDI	50		<b>11.99</b>	<b>07.05</b>	PR: 1LJ,1ZQ									
1.9 TDI			<b>11.99</b>	<b>07.05</b>	PR: 1LJ,1ZQ									
1.9 TDI			<b>11.99</b>	<b>07.05</b>	PR: 1LJ,1ZQ									
1.9 TDI	96		<b>05.03</b>	<b>07.05</b>	PR: 1LJ,1ZQ									
1.9 TDI	110		<b>02.01</b>	<b>07.05</b>	PR: 1LJ,1ZQ									
1.9 TDI Syncro	110		<b>05.02</b>	<b>07.05</b>	PR: 1LJ,1ZQ									
2.3 VR5	110		<b>09.00</b>	<b>07.05</b>	PR: 1LJ,1ZQ									
2.8	150		<b>05.02</b>	<b>07.05</b>	PR: 1LJ,1ZQ									

									
<b>SEAT LEON I (1M1) (99-05)</b>									
	2.8 i Cupra 4x4	150		02.01	07.05	PR: 1LT	G1020512	23392 20,3 +/Wl	ATE
	1.4 i 16V 1.6 i 16V 1.8 20V T 1.8 20V T 4x4 1.8 i 20V 1.8 T 4x4 1.9 SDI 1.9 TDI 1.9 TDI 1.9 TDI 1.9 TDI 1.9 TDI Syncro 2.3 VR5 2.8	132 132 92 154 50		11.99 11.99 11.99 11.99 05.02 11.99 11.99 11.99 05.03 02.01 05.02 09.00 05.02	07.05 07.05 07.05 07.05 07.05 07.05 07.05 07.05 07.05 07.05 07.05 07.05 07.05	PR: 1LR,1LS PR: 1LR,1LS PR: 1LR,1LS PR: 1LR,1LS PR: 1LR,1LS PR: 1LR,1LS PR: 1LR,1LS PR: 1LR,1LS PR: 1LR,1LS PR: 1LR,1LS PR: 1LR,1LS PR: 1LR,1LS PR: 1LR,1LS	G2122150	280 22,0 19,0 V L +S +C	
	1.4 i 16V 1.6 i 16V 1.8 20V T 1.8 20V T 4x4 1.8 i 20V 1.8 T 4x4 1.9 SDI 1.9 TDI 1.9 TDI 1.9 TDI 1.9 TDI 1.9 TDI Syncro 2.3 VR5 2.8	132 132 92 154 50		11.99 11.99 11.99 11.99 05.02 11.99 11.99 11.99 05.03 02.01 05.02 09.00 05.02	07.05 07.05 07.05 07.05 07.05 07.05 07.05 07.05 07.05 07.05 07.05 07.05 07.05	PR: 1LQ PR: 1LQ PR: 1LQ PR: 1LQ PR: 1LQ PR: 1LQ PR: 1LQ PR: 1LQ PR: 1LQ PR: 1LQ PR: 1LQ PR: 1LQ PR: 1LQ	G2122151	256 22,0 19,0 V L +S +C	
	1.4 i 16V 1.6 i 16V 1.8 20V T 1.8 20V T 4x4 1.8 i 20V 1.8 T 4x4 1.9 SDI 1.9 TDI 1.9 TDI 1.9 TDI 1.9 TDI 1.9 TDI Syncro 2.3 VR5 2.8	132 132 92 154 50		11.99 11.99 11.99 11.99 05.02 11.99 11.99 11.99 05.03 02.01 05.02 09.00 05.02	07.05 07.05 07.05 07.05 07.05 07.05 07.05 07.05 07.05 07.05 07.05 07.05 07.05	PR: 1LE PR: 1LE PR: 1LE PR: 1LE PR: 1LE PR: 1LE PR: 1LE PR: 1LE PR: 1LE PR: 1LE PR: 1LE PR: 1LE PR: 1LE	G2125113	288 25,0 22,0 V L +S +C	
	1.4 i 16V 1.6 i 16V 1.8 20V T 1.8 20V T 4x4 1.8 i 20V 1.8 T 4x4 1.8 T Cupra R 1.8 T Cupra R 1.9 SDI 1.9 TDI 1.9 TDI 1.9 TDI 1.9 TDI 1.9 TDI Syncro 2.3 VR5 2.8 2.8 i Cupra 4x4	132 132 92 154 154 165 50		11.99 11.99 11.99 11.99 05.02 05.02 07.03 11.99 11.99 11.99 05.03 02.01 05.02 09.00 05.02 02.01	07.05 07.05 07.05 07.05 07.05 07.05 07.05 07.05 07.05 07.05 07.05 07.05 07.05 07.05 07.05 07.05	PR: 1LJ,1ZQ PR: 1LJ,1ZQ PR: 1LJ,1ZQ PR: 1LJ,1ZQ PR: 1LJ,1ZQ PR: 1LT PR: 1LT PR: 1LJ,1ZQ PR: 1LJ,1ZQ PR: 1LJ,1ZQ PR: 1LJ,1ZQ PR: 1LJ,1ZQ PR: 1LJ,1ZQ PR: 1LJ,1ZQ PR: 1LJ,1ZQ PR: 1LT	G2125123	310 25,0 22,0 V L +C	
	1.4 i 16V 1.6 i 16V 1.8 20V T 1.8 20V T 4x4 1.8 i 20V 1.8 T 4x4 1.9 SDI 1.9 TDI 1.9 TDI 1.9 TDI 1.9 TDI 1.9 TDI Syncro 2.3 VR5 2.8	132 132 92 154 50		11.99 11.99 11.99 11.99 05.02 11.99 11.99 11.99 05.03 02.01 05.02 09.00 05.02	07.05 07.05 07.05 07.05 07.05 07.05 07.05 07.05 07.05 07.05 07.05 07.05 07.05	PR: 1KK,1KP,1KQ PR: 1KK,1KP,1KQ PR: 1KK,1KP,1KQ PR: 1KK,1KP,1KQ PR: 1KK,1KP,1KQ PR: 1KK,1KP,1KQ PR: 1KK,1KP,1KQ PR: 1KK,1KP,1KQ PR: 1KK,1KP,1KQ PR: 1KK,1KP,1KQ PR: 1KK,1KP,1KQ PR: 1KK,1KP,1KQ PR: 1KK,1KP,1KQ	G1020755	20961 17,1 /Acc/S	LUC
	1.4 i 16V 1.6 i 16V 1.8 20V T 1.8 20V T 4x4 1.8 i 20V 1.8 T 4x4 1.8 T Cupra R 1.8 T Cupra R 1.9 SDI 1.9 TDI	132 132 92 154 154 165 50		11.99 11.99 11.99 11.99 05.02 05.02 07.03 11.99 11.99	07.05 07.05 07.05 07.05 07.05 07.05 07.05 07.05 07.05 07.05	PR: 1KY,2EE PR: 1KY,2EE PR: 1KY,2EE PR: 1KY,2EE PR: 1KY,2EE PR: 1KY,2EE PR: 1KY,2EM PR: 1KY,2EM PR: 1KY,2EE PR: 1KY,2EE	G1020676	20961 15,8 /S	LUC



**SEAT LEON I (1M1) (99-05)**

	1.9 TDI 1.9 TDI 1.9 TDI 1.9 TDI Syncro 2.3 VR5 2.8 2.8 i Cupra 4x4	96 110 110 110 150 150	11.99 05.03 02.01 05.02 09.00 05.02 02.01	07.05 07.05 07.05 07.05 07.05 07.05 07.05	PR: 1KY,2EE PR: 1KY,2EE PR: 1KY,2EE PR: 1KY,2EE PR: 1KY,2EE PR: 1KY,2EE PR: 1KY,2EM	G1020676		20961 15,8 /S	LUC
	1.4 i 16V 1.6 i 16V 1.8 20V T 1.8 20V T 4x4 1.8 i 20V 1.8 T 4x4 1.8 T Cupra R 1.8 T Cupra R 1.9 SDI 1.9 TDI 1.9 TDI 1.9 TDI 1.9 TDI Syncro 2.3 VR5 2.8 2.8 i Cupra 4x4	  132 132 92 154 154 165 50  96 110 110 110 150 150	11.99 11.99 11.99 11.99 11.99 05.02 05.02 07.03 11.99 11.99 11.99 02.01 05.02 09.00 05.02 02.01	07.05 07.05 07.05 07.05 07.05 07.05 07.05 07.05 07.05 07.05 07.05 07.05 07.05 07.05 07.05 07.05	PR: 1KY,2EE PR: 1KY,2EE PR: 1KY,2EE PR: 1KY,2EE PR: 1KY,2EE PR: 1KY,2EM PR: 1KY,2EM PR: 1KY,2EE PR: 1KY,2EE PR: 1KY,2EE PR: 1KY,2EE PR: 1KY,2EE PR: 1KY,2EE PR: 1KY,2EE PR: 1KY,2EE	G2122163		256 22,0 20,0 V L +C	
	1.4 i 16V 1.6 i 16V 1.8 20V T 1.8 20V T 4x4 1.8 i 20V 1.8 T 4x4 1.9 SDI 1.9 TDI 1.9 TDI 1.9 TDI 1.9 TDI 1.9 TDI Syncro 2.3 VR5 2.8 2.8 i Cupra 4x4	  132 132 92 154 50  96 110 110 110 110 150 150	11.99 11.99 11.99 11.99 11.99 05.02 11.99 11.99 05.03 02.01 05.02 09.00 05.02 05.02	07.05 07.05 07.05 07.05 07.05 07.05 07.05 07.05 07.05 07.05 07.05 07.05 07.05 07.05	PR: 1KK,1KP,1KQ PR: 1KK,1KP,1KQ PR: 1KK,1KP,1KQ PR: 1KK,1KP,1KQ PR: 1KK,1KP,1KQ PR: 1KK,1KP,1KQ PR: 1KK,1KP,1KQ PR: 1KK,1KP,1KQ PR: 1KK,1KP,1KQ PR: 1KK,1KP,1KQ PR: 1KK,1KP,1KQ PR: 1KK,1KP,1KQ PR: 1KK,1KP,1KQ	G2109123		230 9,0 7,0 +S +C	

**SEAT LEON II (1P1) (05-12)**

	1.2 TSI 1.4 i 16V 1.4 i 16V 1.4 TSI 1.6 i 1.6 i 16V 1.6 LPG 1.6 TDI 1.6 TDI Ecomotive 1.8 T 20V 1.8 T 20V 1.8 TSI 1.9 TDI 1.9 TDI 1.9 TDI 2.0 FSI 2.0 i 16V 2.0 TDI 2.0 TDI 2.0 TFSI 2.0 TFSI 2.0 TFSI	77 55 63 92 75 77 75 66 77 132 165 118 81 110 110 100 125 136 155	02.10 08.05 06.06 11.07 08.05 08.05 12.09 11.10 02.10 08.05 08.05 06.07 08.05 08.05 08.05 08.05 08.05 11.06 08.05 09.05	10.12 10.12	PR: 1ZF,1ZM PR: 1ZF,1ZM PR: 1ZF,1ZM PR: 1ZF,1ZM PR: 1ZF,1ZM PR: 1ZF,1ZM PR: 1ZF,1ZM PR: 1ZF,1ZM PR: 1ZF,1ZM PR: 1ZF,1ZM PR: 1ZF,1ZM PR: 1ZF,1ZM PR: 1ZF,1ZM PR: 1ZF,1ZM PR: 1ZF,1ZM PR: 1ZF,1ZM PR: 1ZF,1ZM PR: 1ZF,1ZM PR: 1ZF,1ZM PR: 1ZF,1ZM	G1020463		23131 19,7 +/Wl	VW
	1.2 TSI 1.4 i 16V 1.4 i 16V 1.4 TSI 1.6 i 1.6 i 16V 1.6 LPG 1.6 TDI 1.6 TDI Ecomotive 1.8 T 20V 1.8 T 20V 1.8 TSI 1.9 TDI 1.9 TDI 1.9 TDI 2.0 FSI 2.0 i 16V 2.0 TDI 2.0 TDI 2.0 TFSI 2.0 TFSI 2.0 TFSI	77 55 63 92 75 77 75 66 77 132 165 118 81 110 110 100 125 136 155	02.10 08.05 06.06 11.07 08.05 08.05 12.09 11.10 02.10 08.05 08.05 06.07 08.05 08.05 08.05 08.05 11.06 08.05 09.05	10.12 10.12	PR: 1ZE,1LJ PR: 1ZE,1LJ PR: 1ZE,1LJ PR: 1ZE,1LJ PR: 1ZE,1LJ PR: 1ZE,1LJ PR: 1ZE,1LJ PR: 1ZE,1LJ PR: 1ZE,1LJ PR: 1ZE,1LJ PR: 1ZE,1LJ PR: 1ZE,1LJ PR: 1ZE,1LJ PR: 1ZE,1LJ PR: 1ZE,1LJ PR: 1ZE,1LJ PR: 1ZE,1LJ PR: 1ZE,1LJ PR: 1ZE,1LJ PR: 1ZE,1LJ	G1020680		23587 20,6 +/Wl	ATE
	1.2 TSI 1.4 i 16V 1.4 i 16V	77 55 63	02.10 08.05 06.06	10.12 10.12 10.12	PR: 1LU PR: 1LU PR: 1LU	G1020753		23801 20,3 +/Wl	ATE



**SEAT LEON II (1P1) (05-12)**

	1.4 TSI	92		11.07	10.12	PR: 1LU	G1020753		23801 20,3 +/Wl	ATE
	1.6 i	75		08.05	10.12	PR: 1LU				
	1.6 i 16V	77		08.05	10.12	PR: 1LU				
	1.6 LPG	75		12.09	10.12	PR: 1LU				
	1.6 TDI	66		11.10	10.12	PR: 1LU				
	1.6 TDI Ecomotive	77		02.10	10.12	PR: 1LU				
	1.8 T 20V	132		08.05	10.12	PR: 1LU				
	1.8 T 20V	165		08.05	10.12	PR: 1LU				
	1.8 TSI	118		06.07	10.12	PR: 1LU				
	1.9 TDI			08.05	10.12	PR: 1LU				
	1.9 TDI	81		08.05	10.12	PR: 1LU				
	1.9 TDI	110		08.05	10.12	PR: 1LU				
	2.0 FSI	110		08.05	10.12	PR: 1LU				
	2.0 i 16V	100		08.05	10.12	PR: 1LU				
	2.0 TDI	125		08.05	10.12	PR: 1LU				
	2.0 TDI			02.06	10.12	PR: 1LU				
	2.0 TFSI			11.06	10.12	PR: 1LU				
2.0 TFSI	136		08.05	10.12	PR: 1LU					
2.0 TFSI	155		09.05	10.12	PR: 1LU					
	1.2 TSI	77		02.10	10.12	PR: 1LB	G1020895		23801 20,3 +/Wl	ATE
	1.4 i 16V	55		08.05	10.12	PR: 1LB				
	1.4 i 16V	63		06.06	10.12	PR: 1LB				
	1.4 TSI	92		11.07	10.12	PR: 1LB				
	1.6 i	75		08.05	10.12	PR: 1LB				
	1.6 i 16V	77		08.05	10.12	PR: 1LB				
	1.6 LPG	75		12.09	10.12	PR: 1LB				
	1.6 TDI	66		11.10	10.12	PR: 1LB				
	1.6 TDI Ecomotive	77		02.10	10.12	PR: 1LB				
	1.8 T 20V	132		08.05	10.12	PR: 1LB				
	1.8 T 20V	165		08.05	10.12	PR: 1LB				
	1.8 TSI	118		06.07	10.12	PR: 1LB				
	1.9 TDI			08.05	10.12	PR: 1LB				
	1.9 TDI	81		08.05	10.12	PR: 1LB				
	1.9 TDI	110		08.05	10.12	PR: 1LB				
	2.0 FSI	110		08.05	10.12	PR: 1LB				
	2.0 i 16V	100		08.05	10.12	PR: 1LB				
2.0 TDI	125		08.05	10.12	PR: 1LB					
2.0 TDI			02.06	10.12	PR: 1LB					
2.0 TFSI			11.06	10.12	PR: 1LB					
2.0 TFSI	136		08.05	10.12	PR: 1LB					
2.0 TFSI	155		09.05	10.12	PR: 1LB					
	1.2 TSI	77		02.10	10.12	PR: 1ZF,1ZM	G2122210		280 22,0 19,0 V L +S +C	
	1.4 i 16V	55		08.05	10.12	PR: 1ZF,1ZM				
	1.4 i 16V	63		06.06	10.12	PR: 1ZF,1ZM				
	1.4 TSI	92		11.07	10.12	PR: 1ZF,1ZM				
	1.6 i	75		08.05	10.12	PR: 1ZF,1ZM				
	1.6 i 16V	77		08.05	10.12	PR: 1ZF,1ZM				
	1.6 LPG	75		12.09	10.12	PR: 1ZF,1ZM				
	1.6 TDI	66		11.10	10.12	PR: 1ZF,1ZM				
	1.6 TDI Ecomotive	77		02.10	10.12	PR: 1ZF,1ZM				
	1.8 T 20V	132		08.05	10.12	PR: 1ZF,1ZM				
	1.8 T 20V	165		08.05	10.12	PR: 1ZF,1ZM				
	1.8 TSI	118		06.07	10.12	PR: 1ZF,1ZM				
	1.9 TDI			08.05	10.12	PR: 1ZF,1ZM				
	1.9 TDI	81		08.05	10.12	PR: 1ZF,1ZM				
	1.9 TDI	110		08.05	10.12	PR: 1ZF,1ZM				
	2.0 FSI	110		08.05	10.12	PR: 1ZF,1ZM				
	2.0 i 16V	100		08.05	10.12	PR: 1ZF,1ZM				
2.0 TDI	125		08.05	10.12	PR: 1ZF,1ZM					
2.0 TDI			02.06	10.12	PR: 1ZF,1ZM					
2.0 TFSI			11.06	10.12	PR: 1ZF,1ZM					
2.0 TFSI	136		08.05	10.12	PR: 1ZF,1ZM					
2.0 TFSI	155		09.05	10.12	PR: 1ZF,1ZM					
	1.2 TSI	77		02.10	10.12	PR: 1ZE	G2125145		288 25,0 22,0 V L +S +C	
	1.4 i 16V	55		08.05	10.12	PR: 1ZE				
	1.4 i 16V	63		06.06	10.12	PR: 1ZE				
	1.4 TSI	92		11.07	10.12	PR: 1ZE				
	1.6 i	75		08.05	10.12	PR: 1ZE				
	1.6 i 16V	77		08.05	10.12	PR: 1ZE				
	1.6 LPG	75		12.09	10.12	PR: 1ZE				
	1.6 TDI	66		11.10	10.12	PR: 1ZE				
	1.6 TDI Ecomotive	77		02.10	10.12	PR: 1ZE				
	1.8 T 20V	132		08.05	10.12	PR: 1ZE				
	1.8 T 20V	165		08.05	10.12	PR: 1ZE				
	1.8 TSI	118		06.07	10.12	PR: 1ZE				
	1.9 TDI			08.05	10.12	PR: 1ZE				
	1.9 TDI	81		08.05	10.12	PR: 1ZE				
	1.9 TDI	110		08.05	10.12	PR: 1ZE				
	2.0 FSI	110		08.05	10.12	PR: 1ZE				
	2.0 i 16V	100		08.05	10.12	PR: 1ZE				
2.0 TDI	125		08.05	10.12	PR: 1ZE					
2.0 TDI			02.06	10.12	PR: 1ZE					
2.0 TFSI			11.06	10.12	PR: 1ZE					
2.0 TFSI	136		08.05	10.12	PR: 1ZE					
2.0 TFSI	155		09.05	10.12	PR: 1ZE					
	1.2 TSI	77		02.10	10.12	PR: 1LJ	G2125158		312 25,0 22,0 V L +S +C	
	1.4 i 16V	55		08.05	10.12	PR: 1LJ				





**SEAT LEON II (1P1) (05-12)**

	1.4 i 16V	63	06.06	10.12	PR: 1LJ	<b>G2125158</b>		312 25,0 22,0 V L +S +C
	1.4 TSI	92	11.07	10.12	PR: 1LJ			
	1.6 i	75	08.05	10.12	PR: 1LJ			
	1.6 i 16V	77	08.05	10.12	PR: 1LJ			
	1.6 LPG	75	12.09	10.12	PR: 1LJ			
	1.6 TDI	66	11.10	10.12	PR: 1LJ			
	1.6 TDI Ecomotive	77	02.10	10.12	PR: 1LJ			
	1.8 T 20V	132	08.05	10.12	PR: 1LJ			
	1.8 T 20V	165	08.05	10.12	PR: 1LJ			
	1.8 TSI	118	06.07	10.12	PR: 1LJ			
	1.9 TDI		08.05	10.12	PR: 1LJ			
	1.9 TDI	81	08.05	10.12	PR: 1LJ			
	1.9 TDI	110	08.05	10.12	PR: 1LJ			
	2.0 FSI	110	08.05	10.12	PR: 1LJ			
	2.0 i 16V	100	08.05	10.12	PR: 1LJ			
	2.0 TDI		08.05	10.12	PR: 1LJ			
	2.0 TDI	125	02.06	10.12	PR: 1LJ			
	2.0 TFSI		11.06	10.12	PR: 1LJ			
	2.0 TFSI	136	08.05	10.12	PR: 1LJ			
	2.0 TFSI	155	09.05	10.12	PR: 1LJ			
	1.2 TSI	77	02.10	10.12	PR: 1LB,1LU	<b>G2130115</b>		345 30,0 27,0 V L +C
	1.4 i 16V	55	08.05	10.12	PR: 1LB,1LU			
	1.4 i 16V	63	06.06	10.12	PR: 1LB,1LU			
	1.4 TSI	92	11.07	10.12	PR: 1LB,1LU			
	1.6 i	75	08.05	10.12	PR: 1LB,1LU			
	1.6 i 16V	77	08.05	10.12	PR: 1LB,1LU			
	1.6 LPG	75	12.09	10.12	PR: 1LB,1LU			
	1.6 TDI	66	11.10	10.12	PR: 1LB,1LU			
	1.6 TDI Ecomotive	77	02.10	10.12	PR: 1LB,1LU			
	1.8 T 20V	132	08.05	10.12	PR: 1LB,1LU			
	1.8 T 20V	165	08.05	10.12	PR: 1LB,1LU			
	1.8 TSI	118	06.07	10.12	PR: 1LB,1LU			
	1.9 TDI		08.05	10.12	PR: 1LB,1LU			
	1.9 TDI	81	08.05	10.12	PR: 1LB,1LU			
	1.9 TDI	110	08.05	10.12	PR: 1LB,1LU			
	2.0 FSI	110	08.05	10.12	PR: 1LB,1LU			
	2.0 i 16V	100	08.05	10.12	PR: 1LB,1LU			
	2.0 TDI		08.05	10.12	PR: 1LB,1LU			
	2.0 TDI	125	02.06	10.12	PR: 1LB,1LU			
	2.0 TFSI		11.06	10.12	PR: 1LB,1LU			
2.0 TFSI	136	08.05	10.12	PR: 1LB,1LU				
2.0 TFSI	155	09.05	10.12	PR: 1LB,1LU				
	1.2 TSI	77	02.10	10.12	PR: 1KD	<b>G1020492</b>		23554 17,1 /WD/S <b>LUC</b>
	1.4 i 16V	55	08.05	10.12	PR: 1KD			
	1.4 i 16V	63	06.06	10.12	PR: 1KD			
	1.4 TSI	92	11.07	10.12	PR: 1KD			
	1.6 i	75	08.05	10.12	PR: 1KD			
	1.6 i 16V	77	08.05	10.12	PR: 1KD			
	1.6 LPG	75	11.06	10.12	PR: 1KD			
	1.6 LPG	75	12.09	10.12	PR: 1KD			
	1.6 TDI	66	11.10	10.12	PR: 1KD			
	1.6 TDI Ecomotive	77	02.10	10.12	PR: 1KD			
	1.8 T 20V	132	08.05	10.12	PR: 1KD			
	1.8 T 20V	165	08.05	10.12	PR: 1KD			
	1.8 TSI	118	06.07	10.12	PR: 1KD			
	1.9 TDI		08.05	10.12	PR: 1KD			
	1.9 TDI	81	08.05	10.12	PR: 1KD			
	1.9 TDI	110	08.05	10.12	PR: 1KD			
	2.0 FSI	110	08.05	10.12	PR: 1KD			
	2.0 i 16V	100	08.05	10.12	PR: 1KD			
	2.0 TDI		08.05	10.12	PR: 1KD			
	2.0 TDI	125	02.06	10.12	PR: 1KD			
2.0 TFSI	136	08.05	10.12	PR: 1KD				
2.0 TFSI	155	09.05	10.12	PR: 1KD				
	1.2 TSI	77	02.10	10.12	PR: 1KY,1KZ	<b>G1020682</b>		23914 17,1 /WD/Acc/S <b>LUC</b>
	1.4 i 16V	55	08.05	10.12	PR: 1KY,1KZ			
	1.4 i 16V	63	06.06	10.12	PR: 1KY,1KZ			
	1.4 TSI	92	11.07	10.12	PR: 1KY,1KZ			
	1.6 i	75	08.05	10.12	PR: 1KY,1KZ			
	1.6 i 16V	77	08.05	10.12	PR: 1KY,1KZ			
	1.6 LPG	75	12.09	10.12	PR: 1KY,1KZ			
	1.6 TDI	66	11.10	10.12	PR: 1KY,1KZ			
	1.6 TDI Ecomotive	77	02.10	10.12	PR: 1KY,1KZ			
	1.8 T 20V	132	08.05	10.12	PR: 1KY,1KZ			
	1.8 T 20V	165	08.05	10.12	PR: 1KY,1KZ			
	1.8 TSI	118	06.07	10.12	PR: 1KY,1KZ			
	1.9 TDI		08.05	10.12	PR: 1KY,1KZ			
	1.9 TDI	81	08.05	10.12	PR: 1KY,1KZ			
	1.9 TDI	110	08.05	10.12	PR: 1KY,1KZ			
	2.0 FSI	110	08.05	10.12	PR: 1KY,1KZ			
	2.0 i 16V	100	08.05	10.12	PR: 1KY,1KZ			
	2.0 TDI		08.05	10.12	PR: 1KY,1KZ			
	2.0 TDI	125	02.06	10.12	PR: 1KY,1KZ			
	2.0 TFSI		11.06	10.12	PR: 1KY,1KZ			
2.0 TFSI	136	08.05	10.12	PR: 1KY,1KZ				
2.0 TFSI	155	09.05	10.12	PR: 1KY,1KZ				



**SEAT LEON II (1P1) (05-12)**

	1.2 TSI	77	02.10	10.12	PR: 1KD	G2110277		253 10,0 8,0 +S +C
	1.4 i 16V	55	08.05	10.12	PR: 1KD			
	1.4 i 16V	63	06.06	10.12	PR: 1KD			
	1.4 TSI	92	11.07	10.12	PR: 1KD			
	1.6 i	75	08.05	10.12	PR: 1KD			
	1.6 i 16V	77	08.05	10.12	PR: 1KD			
	1.6 LPG	75	12.09	10.12	PR: 1KD			
	1.6 TDI	66	11.10	10.12	PR: 1KD			
	1.6 TDI Ecomotive	77	02.10	10.12	PR: 1KD			
	1.8 T 20V	132	08.05	10.12	PR: 1KD			
	1.8 T 20V	165	08.05	10.12	PR: 1KD			
	1.8 TSI	118	06.07	10.12	PR: 1KD			
	1.9 TDI		08.05	10.12	PR: 1KD			
	1.9 TDI	81	08.05	10.12	PR: 1KD			
	1.9 TDI	110	08.05	10.12	PR: 1KD			
	2.0 FSI	110	08.05	10.12	PR: 1KD			
	2.0 i 16V	100	08.05	10.12	PR: 1KD			
	2.0 TDI		08.05	10.12	PR: 1KD			
	2.0 TDI	125	02.06	10.12	PR: 1KD			
	2.0 TFSI		11.06	10.12	PR: 1KD			
	2.0 TFSI	136	08.05	10.12	PR: 1KD			
	2.0 TFSI	155	09.05	10.12	PR: 1KD			
	1.2 TSI	77	02.10	10.12	PR: 1KY,1KZ	G2112169		282 12,0 10,0 +S +C
	1.4 i 16V	55	08.05	10.12	PR: 1KY,1KZ			
	1.4 i 16V	63	06.06	10.12	PR: 1KY,1KZ			
	1.4 TSI	92	11.07	10.12	PR: 1KY,1KZ			
	1.6 i	75	08.05	10.12	PR: 1KY,1KZ			
	1.6 i 16V	77	08.05	10.12	PR: 1KY,1KZ			
	1.6 LPG	75	12.09	10.12	PR: 1KY,1KZ			
	1.6 TDI	66	11.10	10.12	PR: 1KY,1KZ			
	1.6 TDI Ecomotive	77	02.10	10.12	PR: 1KY,1KZ			
	1.8 T 20V	132	08.05	10.12	PR: 1KY,1KZ			
	1.8 T 20V	165	08.05	10.12	PR: 1KY,1KZ			
	1.8 TSI	118	06.07	10.12	PR: 1KY,1KZ			
	1.9 TDI		08.05	10.12	PR: 1KY,1KZ			
	1.9 TDI	81	08.05	10.12	PR: 1KY,1KZ			
	1.9 TDI	110	08.05	10.12	PR: 1KY,1KZ			
	2.0 FSI	110	08.05	10.12	PR: 1KY,1KZ			
	2.0 i 16V	100	08.05	10.12	PR: 1KY,1KZ			
	2.0 TDI		08.05	10.12	PR: 1KY,1KZ			
	2.0 TDI	125	02.06	10.12	PR: 1KY,1KZ			
	2.0 TFSI		11.06	10.12	PR: 1KY,1KZ			
	2.0 TFSI	136	08.05	10.12	PR: 1KY,1KZ			
	2.0 TFSI	155	09.05	10.12	PR: 1KY,1KZ			
	1.2 TSI	77	02.10	10.12	PR: 1KS,1KT	G2110356		272 9,7 8,0 +S +C
	1.4 i 16V	55	08.05	10.12	PR: 1KS,1KT			
	1.4 i 16V	63	06.06	10.12	PR: 1KS,1KT			
	1.4 TSI	92	11.07	10.12	PR: 1KS,1KT			
	1.6 i	75	08.05	10.12	PR: 1KS,1KT			
	1.6 i 16V	77	08.05	10.12	PR: 1KS,1KT			
	1.6 LPG	75	12.09	10.12	PR: 1KS,1KT			
	1.6 TDI	66	11.10	10.12	PR: 1KS,1KT			
	1.6 TDI Ecomotive	77	02.10	10.12	PR: 1KS,1KT			
	1.8 T 20V	132	08.05	10.12	PR: 1KS,1KT			
	1.8 T 20V	165	08.05	10.12	PR: 1KS,1KT			
	1.8 TSI	118	06.07	10.12	PR: 1KS,1KT			
	1.9 TDI		08.05	10.12	PR: 1KS,1KT			
	1.9 TDI	81	08.05	10.12	PR: 1KS,1KT			
	1.9 TDI	110	08.05	10.12	PR: 1KS,1KT			
	2.0 FSI	110	08.05	10.12	PR: 1KS,1KT			
	2.0 i 16V	100	08.05	10.12	PR: 1KS,1KT			
	2.0 TDI		08.05	10.12	PR: 1KS,1KT			
	2.0 TDI	125	02.06	10.12	PR: 1KS,1KT			
	2.0 TFSI		11.06	10.12	PR: 1KS,1KT			
	2.0 TFSI	136	08.05	10.12	PR: 1KS,1KT			
	2.0 TFSI	155	09.05	10.12	PR: 1KS,1KT			

**SEAT LEON III (5F) / SC / ST (12-)**

	1.2 TSI	63	09.12		PR: 1ZA	G2125158		312 25,0 22,0 V L +S +C
	1.2 TSI	77	09.12		PR: 1ZA			
	1.4 TSI	90	09.12		PR: 1ZA			
	1.4 TSI	103	09.12		PR: 1ZA			
	1.6 TDI	66	09.12		PR: 1ZA			
	1.6 TDI	77	09.12		PR: 1ZA			
	1.6 TDI	81	09.13		PR: 1ZA			
	1.8 TFSI	132	09.12		PR: 1ZA			
	2.0 TDI	81	05.13		PR: 1ZA			
	2.0 TDI	105	05.13		PR: 1ZA			
	2.0 TDI	110	09.12		PR: 1ZA			
	2.0 TDI	135	09.12		PR: 1ZA			
	1.2 TSI	63	09.12		PR: 1ZE	G2125145		288 25,0 22,0 V L +S +C
	1.2 TSI	77	09.12		PR: 1ZE			
	1.4 TSI	90	09.12		PR: 1ZE			
	1.4 TSI	103	09.12		PR: 1ZE			
	1.6 TDI	66	09.12		PR: 1ZE			
	1.6 TDI	77	09.12		PR: 1ZE			
	1.6 TDI	81	09.13		PR: 1ZE			





SEAT LEON III (5F) / SC / ST (12-)									
	1.8 TFSI	132		09.12	PR: 1ZE	G2125145			288 25,0 22,0 V L +S +C
	2.0 TDI	81		05.13	PR: 1ZE				
	2.0 TDI	105		05.13	PR: 1ZE				
	2.0 TDI	110		09.12	PR: 1ZE				
	2.0 TDI	135		09.12	PR: 1ZE				
	1.2 TSI	63		09.12	PR: 1KD	G2110277			253 10,0 8,0 +S +C
	1.2 TSI	77		09.12	PR: 1KD				
	1.4 TSI	90		09.12	PR: 1KD				
	1.4 TSI	103		09.12	PR: 1KD				
	1.6 TDI	66		09.12	PR: 1KD				
	1.6 TDI	77		09.12	PR: 1KD				
	1.6 TDI	81		09.13	PR: 1KD				
	1.8 TFSI	132		09.12	PR: 1KD				
	2.0 TDI	81		05.13	PR: 1KD				
	2.0 TDI	105		05.13	PR: 1KD				
	2.0 TDI	110		09.12	PR: 1KD				
	2.0 TDI	135		09.12	PR: 1KD				
	1.2 TSI	63		09.12	PR: 1KS	G2110356			272 9,7 8,0 +S +C
	1.2 TSI	77		09.12	PR: 1KS				
	1.4 TSI	90		09.12	PR: 1KS				
	1.4 TSI	103		09.12	PR: 1KS				
	1.6 TDI	66		09.12	PR: 1KS				
	1.6 TDI	77		09.12	PR: 1KS				
	1.6 TDI	81		09.13	PR: 1KS				
	1.8 TFSI	132		09.12	PR: 1KS				
	2.0 TDI	81		05.13	PR: 1KS				
	2.0 TDI	105		05.13	PR: 1KS				
	2.0 TDI	110		09.12	PR: 1KS				
	2.0 TDI	135		09.12	PR: 1KS				
SEAT MALAGA (85-92)									
	1.2			09.85	12.92	G1020141			20775 18,0 /WI BDX
	1.5			09.85	12.92				
	1.5 i			09.87	12.92				
	1.7 D			09.85	12.92				
SEAT MARBELLA (87-98)									
	0.8			01.87	12.92	G1020141			20775 18,0 /WI BDX
	0.9			01.87	10.98				
SEAT Mii (12-)									
	1.0	44		05.12		G1020331			23130 19,7 + VW
	1.0	55		05.12					
	1.0 EcoFuel	50		11.12					
SEAT TERRA (87-96)									
	0.9			03.87	12.96	G1020141			20775 18,0 /WI BDX
	1.3 D			03.90	12.96				
	1.4 D			01.90	12.96				
SEAT TOLEDO I (1L) (91-98)									
	1.6 i			09.91	08.96	G1020009			20887 19,7 +/Acc VW
	1.8 i			09.91	08.96				
	1.9 D			09.91	08.96				
	1.9 TD	55		09.91	08.96				
	1.8 i 16V			09.91	03.94	G1020444			21945 16,0 /S LUC
	1.9 TDI		1L-TR017000		08.96				
	2.0 i	85		09.91	08.96				
	1.9 TDI		1L-TR016999	04.95		G1020274			20168 19,3 /S LUC
	2.0 i 16V	110		03.94	08.96				
	1.6 i			09.96	09.98	PR: 1LK,1LM	G1020355		21866 19,7 + VW
	1.8 i			09.96	09.98	PR: 1LK,1LM			
	1.9 D			09.96	09.98	PR: 1LK,1LM			
	1.9 TD	55		09.96	09.98	PR: 1LK,1LM			
	1.9 TDI			09.96	09.98	PR: 1LK,1LM			
	2.0 i	85		09.96	09.98	PR: 1LK,1LM			
	2.0 i 16V	110		09.96	09.98	PR: 1LK,1LM			
	1.6 i			09.96	09.98	PR: 1LG	G1020390		21866 15,3 + VW
	1.8 i			09.96	09.98	PR: 1LG			
	1.9 D			09.96	09.98	PR: 1LG			
	1.9 TD	55		09.96	09.98	PR: 1LG			
	1.9 TDI			09.96	09.98	PR: 1LG			
	2.0 i	85		09.96	09.98	PR: 1LG			
	2.0 i 16V	110		09.96	09.98	PR: 1LG			
	1.6 i			09.96	09.98	PR: 1LD,1LV	G1020274		20168 19,3 /S LUC
	1.8 i			09.96	09.98	PR: 1LD,1LV			
	1.9 D			09.96	09.98	PR: 1LD,1LV			
	1.9 TD	55		09.96	09.98	PR: 1LD,1LV			
	1.9 TDI			09.96	09.98	PR: 1LD,1LV			
	2.0 i	85		09.96	09.98	PR: 1LD,1LV			
	2.0 i 16V	110		09.96	09.98	PR: 1LD,1LV			
	1.6 i			09.96	09.98	PR: 1LY,1ZK	G1020444		21945 16,0 /S LUC
	1.8 i			09.96	09.98	PR: 1LY,1ZK			
	1.9 D			09.96	09.98	PR: 1LY,1ZK			
	1.9 TD	55		09.96	09.98	PR: 1LY,1ZK			



SEAT TOLEDO I (1L) (91-98)										
	1.9 TDI 2.0 i 2.0 i 16V	85 110		09.96 09.96 09.96	09.98 09.98 09.98	PR: 1LY,1ZK PR: 1LY,1ZK PR: 1LY,1ZK	G1020444		21945 16,0 /S	LUC
	1.6 i 1.8 i 1.9 D 1.9 TD	55		09.91 09.91 09.91 09.91	08.96 08.96 08.96 08.96		G2112106		239 12,0 10,0 +S +C	
	1.9 TDI		1L-TR016999	04.95			G2113178		256 12,9 11,0 +S +C	
	1.8 i 1.8 i 16V 1.9 TDI 2.0 i	85	1L-TR017000	09.91 09.91 09.91 09.91	08.96 03.94 08.96 08.96		G2120128		256 20,0 18,0 V L +S +C	
	1.6 i 1.8 i 1.9 D 1.9 TD 1.9 TDI 2.0 i 2.0 i 16V	55 85 110		09.96 09.96 09.96 09.96 09.96 09.96 09.96	09.98 09.98 09.98 09.98 09.98 09.98 09.98	PR: 1LK,1LM PR: 1LK,1LM PR: 1LK,1LM PR: 1LK,1LM PR: 1LK,1LM PR: 1LK,1LM PR: 1LK,1LM	G2112106		239 12,0 10,0 +S +C	
	1.6 i 1.8 i 1.9 D 1.9 TD 1.9 TDI 2.0 i 2.0 i 16V	55 85 110		09.96 09.96 09.96 09.96 09.96 09.96 09.96	09.98 09.98 09.98 09.98 09.98 09.98 09.98	PR: 1LG PR: 1LG PR: 1LG PR: 1LG PR: 1LG PR: 1LG PR: 1LG	G2120123		239 20,0 18,0 V L +S +C	
	1.6 i 1.8 i 1.9 D 1.9 TD 1.9 TDI 2.0 i 2.0 i 16V	55 85 110		09.96 09.96 09.96 09.96 09.96 09.96 09.96	09.98 09.98 09.98 09.98 09.98 09.98 09.98	PR: 1LY,1ZK PR: 1LY,1ZK PR: 1LY,1ZK PR: 1LY,1ZK PR: 1LY,1ZK PR: 1LY,1ZK PR: 1LY,1ZK	G2120128		256 20,0 18,0 V L +S +C	
	1.8 i 16V 2.0 i	85	1L-ZD328000	09.91 09.91	03.94		G1020201		20961 15,2 /WD/Acc/S	LUC
	1.9 TDI 2.0 i 2.0 i 16V	85 110	1L-ZD328001	04.95 03.94	08.96 08.96		G1020345		20961 17,0 /WD/Acc/S	LUC
	1.6 i 1.8 i 1.9 D 1.9 TD 1.9 TDI 2.0 i 2.0 i 16V	55 85 110		09.96 09.96 09.96 09.96 09.96 09.96 09.96	09.98 09.98 09.98 09.98 09.98 09.98 09.98	PR: 1KD,1KK PR: 1KD,1KK PR: 1KD,1KK PR: 1KD,1KK PR: 1KD,1KK PR: 1KD,1KK PR: 1KD,1KK	G1020345		20961 17,0 /WD/Acc/S	LUC
	1.8 i 16V 1.9 TDI 2.0 i	85		09.91 11.95 09.91	03.94 08.96 08.96		G2110111	without sensor ring <sup>1)</sup>	226 10,0 8,0 +C	
	1.6 i 1.8 i 1.9 D 1.9 TD 1.9 TDI 2.0 i 2.0 i 16V	55 85 110		09.96 09.96 09.96 09.96 09.96 09.96 09.96	09.98 09.98 09.98 09.98 09.98 09.98 09.98	PR: 1KD PR: 1KD PR: 1KD PR: 1KD PR: 1KD PR: 1KD PR: 1KD	G2110111		226 10,0 8,0 +C	

SEAT TOLEDO II (1M2) (98-04)										
	1.4 i 16V 1.6 i 1.8 4x4 1.8 i 20V 1.8 i 20VT 1.9 SDI 1.9 TDI 1.9 TDI 1.9 TDI 1.9 TDI 2.3 i V5 2.8 2.8 4x4	55 132 50 66 81 96 110 150 150		07.99 10.98 05.01 10.98 05.01 11.99 10.98 10.98 05.03 10.00 10.98 10.00 05.02	09.04 09.04 09.04 09.04 09.04 09.04 09.04 09.04 09.04 09.04 09.04 09.04 09.04	PR: 1LQ PR: 1LQ PR: 1LQ PR: 1LQ PR: 1LQ PR: 1LQ PR: 1LQ PR: 1LQ PR: 1LQ PR: 1LQ PR: 1LQ PR: 1LQ	G1020331		23130 19,7 +	VW
	1.4 i 16V 1.6 i 1.8 4x4 1.8 i 20V 1.8 i 20VT 1.9 SDI 1.9 TDI 1.9 TDI 1.9 TDI 1.9 TDI 2.3 i V5 2.8 2.8 4x4	55 132 50 66 81 96 110 150 150		07.99 10.98 05.01 10.98 05.01 11.99 10.98 10.98 05.03 10.00 10.98 10.00 05.02	09.04 09.04 09.04 09.04 09.04 09.04 09.04 09.04 09.04 09.04 09.04 09.04 09.04	PR: 1LR,1LS PR: 1LR,1LS PR: 1LR,1LS PR: 1LR,1LS PR: 1LR,1LS PR: 1LR,1LS PR: 1LR,1LS PR: 1LR,1LS PR: 1LR,1LS PR: 1LR,1LS PR: 1LR,1LS PR: 1LR,1LS	G1020463		23131 19,7 +/Wl	VW
	1.4 i 16V 1.6 i	55	X-800 000 X-800 000	07.99 10.98		PR: 1LN,1LE,1ZE,1ZH PR: 1LN,1LE,1ZE,1ZH	G1020379		21911 20,3 +	ATE













<sup>1)</sup> senza sensori / sans secours ABS / sin anillo sensor ABS / ohne Sensoring







































**SEAT TOLEDO II (1M2) (98-04)**

	1.8 4x4		X-800 000	05.01	PR: 1LN,1LE,1ZE,1ZH	G1020379		21911 20,3 +	ATE
	1.8 i 20V		X-800 000	10.98	PR: 1LN,1LE,1ZE,1ZH				
	1.8 i 20V	132	X-800 000	05.01	PR: 1LN,1LE,1ZE,1ZH				
	1.9 SDI	50	X-800 000	11.99	PR: 1LN,1LE,1ZE,1ZH				
	1.9 TDI	66	X-800 000	10.98	PR: 1LN,1LE,1ZE,1ZH				
	1.9 TDI	81	X-800 000	10.98	PR: 1LN,1LE,1ZE,1ZH				
	1.9 TDI	96	X-800 000	05.03	PR: 1LN,1LE,1ZE,1ZH				
	1.9 TDI	110	X-800 000	10.00	PR: 1LN,1LE,1ZE,1ZH				
	2.3 i V5		X-800 000	10.98	PR: 1LN,1LE,1ZE,1ZH				
	2.8	150	X-800 000	10.00	PR: 1LN,1LE,1ZE,1ZH				
2.8 4x4	150	X-800 000	05.02	PR: 1LN,1LE,1ZE,1ZH					
	1.4 i 16V	55	Y-000 001	09.04	PR: 1LN,1LE,1ZE,1ZH	G1020512		23392 20,3 +/Wl	ATE
	1.6 i		Y-000 001	09.04	PR: 1LN,1LE,1ZE,1ZH				
	1.8 4x4		Y-000 001	09.04	PR: 1LN,1LE,1ZE,1ZH				
	1.8 i 20V		Y-000 001	09.04	PR: 1LN,1LE,1ZE,1ZH				
	1.8 i 20V	132	Y-000 001	09.04	PR: 1LN,1LE,1ZE,1ZH				
	1.9 SDI	50	Y-000 001	09.04	PR: 1LN,1LE,1ZE,1ZH				
	1.9 TDI	66	Y-000 001	09.04	PR: 1LN,1LE,1ZE,1ZH				
	1.9 TDI	81	Y-000 001	09.04	PR: 1LN,1LE,1ZE,1ZH				
	1.9 TDI	96	Y-000 001	09.04	PR: 1LN,1LE,1ZE,1ZH				
	1.9 TDI	110	Y-000 001	09.04	PR: 1LN,1LE,1ZE,1ZH				
2.3 i V5		Y-000 001	09.04	PR: 1LN,1LE,1ZE,1ZH					
2.8	150	Y-000 001	09.04	PR: 1LN,1LE,1ZE,1ZH					
2.8 4x4	150	Y-000 001	09.04	PR: 1LN,1LE,1ZE,1ZH					
	1.4 i 16V	55		07.99	09.04 PR: 1LJ,1ZQ	G1020512		23392 20,3 +/Wl	ATE
	1.6 i			10.98	09.04 PR: 1LJ,1ZQ				
	1.8 4x4			05.01	09.04 PR: 1LJ,1ZQ				
	1.8 i 20V			10.98	09.04 PR: 1LJ,1ZQ				
	1.8 i 20V	132		05.01	09.04 PR: 1LJ,1ZQ				
	1.9 SDI	50		11.99	09.04 PR: 1LJ,1ZQ				
	1.9 TDI	66		04.99	09.04 PR: 1LJ,1ZQ				
	1.9 TDI	81		10.98	09.04 PR: 1LJ,1ZQ				
	1.9 TDI	96		05.03	09.04 PR: 1LJ,1ZQ				
	1.9 TDI	110		10.00	09.04 PR: 1LJ,1ZQ				
2.3 i V5			10.98	09.04 PR: 1LJ,1ZQ					
2.8	150		10.00	09.04 PR: 1LJ,1ZQ					
2.8 4x4	150		05.02	09.04 PR: 1LJ,1ZQ					
	1.4 i 16V	55		07.99	09.04 PR: 1LQ	G2122151		256 22,0 19,0 V L +S +C	
	1.6 i			10.98	09.04 PR: 1LQ				
	1.8 4x4			05.01	09.04 PR: 1LQ				
	1.8 i 20V			10.98	09.04 PR: 1LQ				
	1.8 i 20V	132		05.01	09.04 PR: 1LQ				
	1.9 SDI	50		11.99	09.04 PR: 1LQ				
	1.9 TDI	66		10.98	09.04 PR: 1LQ				
	1.9 TDI	81		10.98	09.04 PR: 1LQ				
	1.9 TDI	96		05.03	09.04 PR: 1LQ				
	1.9 TDI	110		10.00	09.04 PR: 1LQ				
2.3 i V5			10.98	09.04 PR: 1LQ					
2.8	150		10.00	09.04 PR: 1LQ					
2.8 4x4	150		05.02	09.04 PR: 1LQ					
	1.4 i 16V	55		07.99	09.04 PR: 1LR,1LS	G2122150		280 22,0 19,0 V L +S +C	
	1.6 i			10.98	09.04 PR: 1LR,1LS				
	1.8 4x4			05.01	09.04 PR: 1LR,1LS				
	1.8 i 20V			10.98	09.04 PR: 1LR,1LS				
	1.8 i 20V	132		05.01	09.04 PR: 1LR,1LS				
	1.9 SDI	50		11.99	09.04 PR: 1LR,1LS				
	1.9 TDI	66		10.98	09.04 PR: 1LR,1LS				
	1.9 TDI	81		10.98	09.04 PR: 1LR,1LS				
	1.9 TDI	96		05.03	09.04 PR: 1LR,1LS				
	1.9 TDI	110		10.00	09.04 PR: 1LR,1LS				
2.3 i V5			10.98	09.04 PR: 1LR,1LS					
2.8	150		10.00	09.04 PR: 1LR,1LS					
2.8 4x4	150		05.02	09.04 PR: 1LR,1LS					
	1.4 i 16V	55		07.99	09.04 PR: 1LJ,1ZQ	G2125123		310 25,0 22,0 V L +C	
	1.6 i			10.98	09.04 PR: 1LJ,1ZQ				
	1.8 4x4			05.01	09.04 PR: 1LJ,1ZQ				
	1.8 i 20V			10.98	09.04 PR: 1LJ,1ZQ				
	1.8 i 20V	132		05.01	09.04 PR: 1LJ,1ZQ				
	1.9 SDI	50		11.99	09.04 PR: 1LJ,1ZQ				
	1.9 TDI	66		04.99	09.04 PR: 1LJ,1ZQ				
	1.9 TDI	81		10.98	09.04 PR: 1LJ,1ZQ				
	1.9 TDI	96		05.03	09.04 PR: 1LJ,1ZQ				
	1.9 TDI	110		10.00	09.04 PR: 1LJ,1ZQ				
2.3 i V5			10.98	09.04 PR: 1LJ,1ZQ					
2.8	150		10.00	09.04 PR: 1LJ,1ZQ					
2.8 4x4	150		05.02	09.04 PR: 1LJ,1ZQ					
	1.4 i 16V	55		07.99	09.04 PR: 1LN,1LE,1ZE,1ZH	G2125113		288 25,0 22,0 V L +S +C	
	1.6 i			10.98	09.04 PR: 1LN,1LE,1ZE,1ZH				
	1.8 4x4			05.01	09.04 PR: 1LN,1LE,1ZE,1ZH				
	1.8 i 20V			10.98	09.04 PR: 1LN,1LE,1ZE,1ZH				
	1.8 i 20V	132		05.01	09.04 PR: 1LN,1LE,1ZE,1ZH				
	1.9 SDI	50		11.99	09.04 PR: 1LN,1LE,1ZE,1ZH				
	1.9 TDI	66		04.99	09.04 PR: 1LN,1LE,1ZE,1ZH				
	1.9 TDI	81		10.98	09.04 PR: 1LN,1LE,1ZE,1ZH				
	1.9 TDI	96		05.03	09.04 PR: 1LN,1LE,1ZE,1ZH				
	1.9 TDI	110		10.00	09.04 PR: 1LN,1LE,1ZE,1ZH				
2.3 i V5			10.98	09.04 PR: 1LN,1LE,1ZE,1ZH					

								
<b>SEAT TOLEDO II (1M2) (98-04)</b>								
	2.8 2.8 4x4	150 150		10.00 05.02	09.04 09.04	PR: 1LN,1LE,1ZE,1ZH PR: 1LN,1LE,1ZE,1ZH	G2125113	288 25,0 22,0 V L +S +C
	1.4 i 16V 1.6 i 1.8 4x4 1.8 i 20V 1.8 i 20VT 1.9 SDI 1.9 TDI 1.9 TDI 1.9 TDI 1.9 TDI 2.3 i V5 2.8 2.8 4x4	55   132 50 66 81 96 110  150 150		07.99 10.98 05.01 10.98 05.01 11.99 10.98 10.98 05.03 10.00 10.98 10.00 05.02	09.04 09.04 09.04 09.04 09.04 09.04 09.04 09.04 09.04 09.04 09.04 09.04 09.04	PR: 1KK,1KP,1KQ PR: 1KK,1KP,1KQ PR: 1KK,1KP,1KQ PR: 1KK,1KP,1KQ PR: 1KK,1KP,1KQ PR: 1KK,1KP,1KQ PR: 1KK,1KP,1KQ PR: 1KK,1KP,1KQ PR: 1KK,1KP,1KQ PR: 1KK,1KP,1KQ PR: 1KK,1KP,1KQ PR: 1KK,1KP,1KQ	G1020755	20961 17,1 /Acc/S LUC
	1.4 i 16V 1.6 i 1.8 4x4 1.8 i 20V 1.8 i 20VT 1.9 SDI 1.9 TDI 1.9 TDI 1.9 TDI 1.9 TDI 2.3 i V5 2.8 2.8 4x4	55   132 50 66 81 96 110  150 150		07.99 10.98 05.01 10.98 05.01 11.99 10.98 10.98 05.03 10.00 10.98 10.00 05.02	09.04 09.04 09.04 09.04 09.04 09.04 09.04 09.04 09.04 09.04 09.04 09.04 09.04	PR: 1KY,2EE PR: 1KY,2EE PR: 1KY,2EE PR: 1KY,2EE PR: 1KY,2EE PR: 1KY,2EE PR: 1KY,2EE PR: 1KY,2EE PR: 1KY,2EE PR: 1KY,2EE PR: 1KY,2EE PR: 1KY,2EE	G1020676	20961 15,8 /S LUC
	1.4 i 16V 1.6 i 1.8 4x4 1.8 i 20V 1.8 i 20VT 1.9 SDI 1.9 TDI 1.9 TDI 1.9 TDI 1.9 TDI 2.3 i V5 2.8 2.8 4x4	55   132 50 66 81 96 110  150 150		07.99 10.98 05.01 10.98 05.01 11.99 10.98 10.98 05.03 10.00 10.98 10.00 05.02	09.04 09.04 09.04 09.04 09.04 09.04 09.04 09.04 09.04 09.04 09.04 09.04 09.04	PR: 1KK,1KP,1KQ PR: 1KK,1KP,1KQ PR: 1KK,1KP,1KQ PR: 1KK,1KP,1KQ PR: 1KK,1KP,1KQ PR: 1KK,1KP,1KQ PR: 1KK,1KP,1KQ PR: 1KK,1KP,1KQ PR: 1KK,1KP,1KQ PR: 1KK,1KP,1KQ PR: 1KK,1KP,1KQ PR: 1KK,1KP,1KQ	G2109123	230 9,0 7,0 +S +C
	1.4 i 16V 1.6 i 1.8 4x4 1.8 i 20V 1.8 i 20VT 1.9 SDI 1.9 TDI 1.9 TDI 1.9 TDI 1.9 TDI 2.3 i V5 2.8 2.8 4x4	55   132 50 66 81 96 110  150 150		07.99 10.98 05.01 10.98 05.01 11.99 10.98 10.98 05.03 10.00 10.98 10.00 05.02	09.04 09.04 09.04 09.04 09.04 09.04 09.04 09.04 09.04 09.04 09.04 09.04 09.04	PR: 1KY,2EE PR: 1KY,2EE PR: 1KY,2EE PR: 1KY,2EE PR: 1KY,2EE PR: 1KY,2EE PR: 1KY,2EE PR: 1KY,2EE PR: 1KY,2EE PR: 1KY,2EE PR: 1KY,2EE PR: 1KY,2EE	G2122163	256 22,0 20,0 V L +C
<b>SEAT TOLEDO III (5P2) (05-09)</b>								
	1.6 i 16V 1.8 TFSI 1.9 TDI 2.0 FSI 2.0 i 16V 2.0 TDI 2.0 TDI 2.0 TFSI	75 118 77 110 100 125 147		10.04 01.07 10.04 10.04 10.04 01.06 11.05	03.09 03.09 03.09 03.09 03.09 03.09 03.09	PR: 1ZF PR: 1ZF PR: 1ZF PR: 1ZF PR: 1ZF PR: 1ZF PR: 1ZF	G1020463	23131 19,7 +/Wl VW
	1.6 i 16V 1.8 TFSI 1.9 TDI 2.0 FSI 2.0 i 16V 2.0 TDI 2.0 TDI 2.0 TFSI	75 118 77 110 100 125 147		10.04 01.07 10.04 10.04 10.04 01.06 11.05	03.09 03.09 03.09 03.09 03.09 03.09 03.09	PR: 1ZE PR: 1ZE PR: 1ZE PR: 1ZE PR: 1ZE PR: 1ZE PR: 1ZE	G1020680	23587 20,6 +/Wl ATE
	1.6 i 16V 1.8 TFSI 1.9 TDI 2.0 FSI 2.0 i 16V 2.0 TDI 2.0 TDI 2.0 TFSI	75 118 77 110 100 125 147		10.04 01.07 10.04 10.04 10.04 01.06 11.05	03.09 03.09 03.09 03.09 03.09 03.09 03.09	PR: 1ZF PR: 1ZF PR: 1ZF PR: 1ZF PR: 1ZF PR: 1ZF PR: 1ZF	G2122210	280 22,0 19,0 V L +S +C
	1.6 i 16V 1.8 TFSI 1.9 TDI 2.0 FSI 2.0 i 16V	75 118 77 110 100		10.04 01.07 10.04 10.04 10.04	03.09 03.09 03.09 03.09 03.09	PR: 1ZE PR: 1ZE PR: 1ZE PR: 1ZE PR: 1ZE	G2125145	288 25,0 22,0 V L +S +C

								
<b>SEAT TOLEDO III (5P2) (05-09)</b>								
	2.0 TDI 2.0 TDI 2.0 TFSI	125 125 147		10.04 01.06 11.05	03.09 03.09 03.09	PR: 1ZE PR: 1ZE PR: 1ZE	G2125145	288 25,0 22,0 V L +S +C
	1.6 i 16V 1.8 TFSI 1.9 TDI 2.0 FSI 2.0 i 16V 2.0 TDI 2.0 TDI 2.0 TFSI	75 118 77 110 100 125 147		10.04 01.07 10.04 10.04 10.04 10.04 01.06 11.05	03.09 03.09 03.09 03.09 03.09 03.09 03.09 03.09	PR: 1KD PR: 1KD PR: 1KD PR: 1KD PR: 1KD PR: 1KD PR: 1KD PR: 1KD	G1020492	23554 17,1 /WD/S LUC
	1.6 i 16V 1.8 TFSI 1.9 TDI 2.0 FSI 2.0 i 16V 2.0 TDI 2.0 TDI 2.0 TFSI	75 118 77 110 100 125 147		10.04 01.07 10.04 10.04 10.04 10.04 01.06 11.05	03.09 03.09 03.09 03.09 03.09 03.09 03.09 03.09	PR: 1KF,1KJ,1KZ PR: 1KF,1KJ,1KZ PR: 1KF,1KJ,1KZ PR: 1KF,1KJ,1KZ PR: 1KF,1KJ,1KZ PR: 1KF,1KJ,1KZ PR: 1KF,1KJ,1KZ PR: 1KF,1KJ,1KZ	G1020682	23914 17,1 /WD/Acc/S LUC
	1.6 i 16V 1.8 TFSI 1.9 TDI 2.0 FSI 2.0 i 16V 2.0 TDI 2.0 TDI 2.0 TFSI	75 118 77 110 100 125 147		10.04 01.07 10.04 10.04 10.04 10.04 01.06 11.05	03.09 03.09 03.09 03.09 03.09 03.09 03.09 03.09	PR: 1KD PR: 1KD PR: 1KD PR: 1KD PR: 1KD PR: 1KD PR: 1KD PR: 1KD	G2110277	253 10,0 8,0 +S +C
	1.6 i 16V 1.8 TFSI 1.9 TDI 2.0 FSI 2.0 i 16V 2.0 TDI 2.0 TDI 2.0 TFSI	75 118 77 110 100 125 147		10.04 01.07 10.04 10.04 10.04 10.04 01.06 11.05	03.09 03.09 03.09 03.09 03.09 03.09 03.09 03.09	PR: 1KJ,1KZ PR: 1KJ,1KZ PR: 1KJ,1KZ PR: 1KJ,1KZ PR: 1KJ,1KZ PR: 1KJ,1KZ PR: 1KJ,1KZ PR: 1KJ,1KZ	G2112169	282 12,0 10,0 +S +C
	1.6 i 16V 1.8 TFSI 1.9 TDI 2.0 FSI 2.0 i 16V 2.0 TDI 2.0 TDI 2.0 TFSI	75 118 77 110 100 125 147		10.04 01.07 10.04 10.04 10.04 10.04 01.06 11.05	03.09 03.09 03.09 03.09 03.09 03.09 03.09 03.09	PR: 1KF PR: 1KF PR: 1KF PR: 1KF PR: 1KF PR: 1KF PR: 1KF PR: 1KF	G2112158	256 12,0 10,0 +C
<b>SEAT TOLEDO IV (KG3) (12-)</b>								
	1.2 1.2 TSI 1.2 TSI 1.4 TSI 1.6 1.6 TDI	55 63 77 90 77 77		07.12 07.12 07.12 07.12 07.13 07.12		PR: 1ZG PR: 1ZG PR: 1ZG PR: 1ZG PR: 1ZG PR: 1ZG	G1020331	23130 19,7 + VW
	1.2 1.2 TSI 1.2 TSI 1.4 TSI 1.6 1.6 TDI	55 63 77 90 77 77		07.12 07.12 07.12 07.12 07.13 07.12		+ 15" wheel <sup>1)</sup> + 15" wheel <sup>1)</sup> + 15" wheel <sup>1)</sup> + 15" wheel <sup>1)</sup> + 15" wheel <sup>1)</sup> + 15" wheel <sup>1)</sup>	G1020680	23587 20,6 +/WI ATE
	1.2 1.2 TSI 1.2 TSI 1.4 TSI 1.6 1.6 TDI	55 63 77 90 77 77		07.12 07.12 07.12 07.12 07.13 07.12		PR: 1ZG PR: 1ZG PR: 1ZG PR: 1ZG PR: 1ZG PR: 1ZG	G2122151	256 22,0 19,0 V L +S +C
	1.2 1.2 TSI 1.2 TSI 1.4 TSI 1.6 1.6 TDI	55 63 77 90 77 77		07.12 07.12 07.12 07.12 07.13 07.12		+ 15" wheel <sup>1)</sup> + 15" wheel <sup>1)</sup> + 15" wheel <sup>1)</sup> + 15" wheel <sup>1)</sup> + 15" wheel <sup>1)</sup> + 15" wheel <sup>1)</sup>	G2125113	288 25,0 22,0 V L +S +C
	1.2 1.2 TSI 1.2 TSI 1.4 TSI 1.6 1.6 TDI	55 63 77 90 77 77		07.12 07.12 07.12 07.12 07.13 07.12			G1020755	20961 17,1 /Acc/S LUC
	1.2 1.2 TSI 1.2 TSI 1.4 TSI 1.6 1.6 TDI	55 63 77 90 77 77		07.12 07.12 07.12 07.12 07.13 07.12			G2109123	230 9,0 7,0 +S +C

<sup>1)</sup> + ruota 15" / + roue 15" / + rueda 15" / + 15" Rad

									
<b>SKODA CITIGO (12-)</b>									
	1.0	44	05.12		G1020331			23130 19,7 +	VW
	1.0	55	05.12						
	1.0 CNG	50	11.12						
<b>SKODA FABIA I (6Y) (99-07)</b>									
	1.0 i		02.00	08.02	PR: 1LB,1LM	G1020408		21866 17,2 +	VW
	1.2 i		08.02	12.07	PR: 1LB,1LM	G1020409		21868 17,2 +/Wl	VW
	1.4 i		02.00	12.07	PR: 1LB,1LM				
	1.4 i 16V		10.99	12.07	PR: 1LB,1LM				
	1.4 TDI		04.03	12.07	PR: 1LB,1LM				
	1.9 SDI	47	12.99	12.07	PR: 1LB,1LM				
	1.9 TDI	74	02.00	12.07	PR: 1LB,1LM				
	2.0 i	85	12.99	12.07	PR: 1LB,1LM				
	RS 1.9 TDI	96	09.03	12.07	PR: 1LB,1LM				
	1.0 i		02.00	08.02	PR: 1LQ,1LR	G1020331		23130 19,7 +	VW
	1.2 i		08.02	12.07	PR: 1LQ,1LR	G1020463		23131 19,7 +/Wl	VW
	1.4 i		02.00	12.07	PR: 1LQ,1LR				
	1.4 i 16V		10.99	12.07	PR: 1LQ,1LR				
	1.4 TDI		04.03	12.07	PR: 1LQ,1LR				
	1.9 SDI	47	12.99	12.07	PR: 1LQ,1LR				
	1.9 TDI	74	02.00	12.07	PR: 1LQ,1LR				
	2.0 i	85	12.99	12.07	PR: 1LQ,1LR				
	RS 1.9 TDI	96	09.03	12.07	PR: 1LQ,1LR				
	1.0 i		02.00	08.02	PR: 1LN,1LP	G1020732		23581 18,8 /S	LUC
	1.2 i		08.02	12.07	PR: 1LN,1LP	G1020733		23843 18,8 +/Wl/S	LUC
	1.4 i		02.00	12.07	PR: 1LN,1LP				
	1.4 i 16V		10.99	12.07	PR: 1LN,1LP				
	1.4 TDI		04.03	12.07	PR: 1LN,1LP				
	1.9 SDI	47	12.99	12.07	PR: 1LN,1LP				
	1.9 TDI	74	02.00	12.07	PR: 1LN,1LP				
	2.0 i	85	12.99	12.07	PR: 1LN,1LP				
	RS 1.9 TDI	96	09.03	12.07	PR: 1LN,1LP				
	1.0 i		02.00	08.02	PR: 1LB,1LM	G2118137		239 18,0 16,0 V L +S +C	
	1.2 i		08.02	12.07	PR: 1LB,1LM				
	1.4 i		02.00	12.07	PR: 1LB,1LM				
	1.4 i 16V		10.99	12.07	PR: 1LB,1LM				
	1.4 TDI		04.03	12.07	PR: 1LB,1LM				
	1.9 SDI	47	12.99	12.07	PR: 1LB,1LM				
	1.9 TDI	74	02.00	12.07	PR: 1LB,1LM				
	2.0 i	85	12.99	12.07	PR: 1LB,1LM				
	RS 1.9 TDI	96	09.03	12.07	PR: 1LB,1LM				
	1.0 i		02.00	08.02	PR: 1LQ,1LR	G2122151		256 22,0 19,0 V L +S +C	
	1.2 i		08.02	12.07	PR: 1LQ,1LR				
	1.4 i		02.00	12.07	PR: 1LQ,1LR				
	1.4 i 16V		10.99	12.07	PR: 1LQ,1LR				
	1.4 TDI		04.03	12.07	PR: 1LQ,1LR				
	1.9 SDI	47	12.99	12.07	PR: 1LQ,1LR				
	1.9 TDI	74	02.00	12.07	PR: 1LQ,1LR				
	2.0 i	85	12.99	12.07	PR: 1LQ,1LR				
	RS 1.9 TDI	96	09.03	12.07	PR: 1LQ,1LR				
	1.0 i		02.00	08.02	PR: 1LN,1LP	G2125113		288 25,0 22,0 V L +S +C	
	1.2 i		08.02	12.07	PR: 1LN,1LP				
	1.4 i		02.00	12.07	PR: 1LN,1LP				
	1.4 i 16V		10.99	12.07	PR: 1LN,1LP				
	1.4 TDI		04.03	12.07	PR: 1LN,1LP				
	1.9 SDI	47	12.99	12.07	PR: 1LN,1LP				
	1.9 TDI	74	02.00	12.07	PR: 1LN,1LP				
	2.0 i	85	12.99	12.07	PR: 1LN,1LP				
	RS 1.9 TDI	96	09.03	12.07	PR: 1LN,1LP				
	1.4 i 16V		10.99	12.07	PR: 1KK,1KP	G1020755		20961 17,1 /Acc/S	LUC
	1.4 TDI		04.03	12.07	PR: 1KK,1KP				
	1.9 TDI	74	02.00	12.07	PR: 1KK,1KP				
	2.0 i	85	12.99	12.07	PR: 1KK,1KP				
	RS 1.9 TDI	96	09.03	12.07	PR: 1KK,1KP				
	1.4 i 16V		10.99	12.07	PR: 1KK,1KP	G2109123		230 9,0 7,0 +S +C	
	1.4 TDI		04.03	12.07	PR: 1KK,1KP				
	1.9 TDI	74	02.00	12.07	PR: 1KK,1KP				
	2.0 i	85	12.99	12.07	PR: 1KK,1KP				
	RS 1.9 TDI	96	09.03	12.07	PR: 1KK,1KP				
<b>SKODA FABIA II (5J) (07-)</b>									
	1.2	44	03.07		PR: 1LB,1LM	G1020408		21866 17,2 +	VW
	1.2	51	03.07		PR: 1LB,1LM	G1020409		21868 17,2 +/Wl	VW
	1.2 TDI	55	05.10		PR: 1LB,1LM				
	1.2 TSI	63	03.10		PR: 1LB,1LM				
	1.2 TSI	77	03.10		PR: 1LB,1LM				
	1.4 i 16V	63	03.07		PR: 1LB,1LM				
	1.4 TDI	51	03.07		PR: 1LB,1LM				
	1.4 TDI	59	03.07		PR: 1LB,1LM				
	1.4 TSI RS	132	05.10		PR: 1LB,1LM				
	1.6 i 16V	77	03.07		PR: 1LB,1LM				
	1.6 TDI	55	04.10		PR: 1LB,1LM				
	1.6 TDI	66	03.10		PR: 1LB,1LM				
	1.6 TDI	77	03.10		PR: 1LB,1LM				
	1.9 TDI	77	03.07		PR: 1LB,1LM				





**SKODA FABIA II (5J) (07-)**

	1.2	44		03.07	PR: 1LQ,1LR,1ZG	G1020331 G1020463		23130 19,7 + 23131 19,7 +/Wl	VW VW
	1.2	51		03.07	PR: 1LQ,1LR,1ZG				
	1.2 TDI	55		05.10	PR: 1LQ,1LR,1ZG				
	1.2 TSI	63		03.10	PR: 1LQ,1LR,1ZG				
	1.2 TSI	77		03.10	PR: 1LQ,1LR,1ZG				
	1.4 i 16V	63		03.07	PR: 1LQ,1LR,1ZG				
	1.4 TDI	51		03.07	PR: 1LQ,1LR,1ZG				
	1.4 TDI	59		03.07	PR: 1LQ,1LR,1ZG				
	1.4 TSI RS	132		05.10	PR: 1LQ,1LR,1ZG				
	1.6 i 16V	77		03.07	PR: 1LQ,1LR,1ZG				
	1.6 TDI	55		04.10	PR: 1LQ,1LR,1ZG				
	1.6 TDI	66		03.10	PR: 1LQ,1LR,1ZG				
	1.6 TDI	77		03.10	PR: 1LQ,1LR,1ZG				
1.9 TDI	77		03.07	PR: 1LQ,1LR,1ZG					
	1.2	44		03.07	PR: 1LN,1ZH	G1020732 G1020733		23581 18,8 /S 23843 18,8 +/Wl/S	LUC LUC
	1.2	51		03.07	PR: 1LN,1ZH				
	1.2 TDI	55		05.10	PR: 1LN,1ZH				
	1.2 TSI	63		03.10	PR: 1LN,1ZH				
	1.2 TSI	77		03.10	PR: 1LN,1ZH				
	1.4 i 16V	63		03.07	PR: 1LN,1ZH				
	1.4 TDI	51		03.07	PR: 1LN,1ZH				
	1.4 TDI	59		03.07	PR: 1LN,1ZH				
	1.4 TSI RS	132		05.10	PR: 1LN,1ZH				
	1.6 i 16V	77		03.07	PR: 1LN,1ZH				
	1.6 TDI	55		04.10	PR: 1LN,1ZH				
	1.6 TDI	66		03.10	PR: 1LN,1ZH				
	1.6 TDI	77		03.10	PR: 1LN,1ZH				
1.9 TDI	77		03.07	PR: 1LN,1ZH					
	1.2	44		03.07	PR: 1LB,1LM	G2118137		239 18,0 16,0 V L +S +C	
	1.2	51		03.07	PR: 1LB,1LM				
	1.2 TDI	55		05.10	PR: 1LB,1LM				
	1.2 TSI	63		03.10	PR: 1LB,1LM				
	1.2 TSI	77		03.10	PR: 1LB,1LM				
	1.4 i 16V	63		03.07	PR: 1LB,1LM				
	1.4 TDI	51		03.07	PR: 1LB,1LM				
	1.4 TDI	59		03.07	PR: 1LB,1LM				
	1.4 TSI RS	132		05.10	PR: 1LB,1LM				
	1.6 i 16V	77		03.07	PR: 1LB,1LM				
	1.6 TDI	55		04.10	PR: 1LB,1LM				
	1.6 TDI	66		03.10	PR: 1LB,1LM				
	1.6 TDI	77		03.10	PR: 1LB,1LM				
1.9 TDI	77		03.07	PR: 1LB,1LM					
	1.2	44		03.07	PR: 1LQ,1LR,1ZG	G2122151		256 22,0 19,0 V L +S +C	
	1.2	51		03.07	PR: 1LQ,1LR,1ZG				
	1.2 TDI	55		05.10	PR: 1LQ,1LR,1ZG				
	1.2 TSI	63		03.10	PR: 1LQ,1LR,1ZG				
	1.2 TSI	77		03.10	PR: 1LQ,1LR,1ZG				
	1.4 i 16V	63		03.07	PR: 1LQ,1LR,1ZG				
	1.4 TDI	51		03.07	PR: 1LQ,1LR,1ZG				
	1.4 TDI	59		03.07	PR: 1LQ,1LR,1ZG				
	1.4 TSI RS	132		05.10	PR: 1LQ,1LR,1ZG				
	1.6 i 16V	77		03.07	PR: 1LQ,1LR,1ZG				
	1.6 TDI	55		04.10	PR: 1LQ,1LR,1ZG				
	1.6 TDI	66		03.10	PR: 1LQ,1LR,1ZG				
	1.6 TDI	77		03.10	PR: 1LQ,1LR,1ZG				
1.9 TDI	77		03.07	PR: 1LQ,1LR,1ZG					
	1.2	44		03.07	PR: 1LN,1ZH	G2125113		288 25,0 22,0 V L +S +C	
	1.2	51		03.07	PR: 1LN,1ZH				
	1.2 TDI	55		05.10	PR: 1LN,1ZH				
	1.2 TSI	63		03.10	PR: 1LN,1ZH				
	1.2 TSI	77		03.10	PR: 1LN,1ZH				
	1.4 i 16V	63		03.07	PR: 1LN,1ZH				
	1.4 TDI	51		03.07	PR: 1LN,1ZH				
	1.4 TDI	59		03.07	PR: 1LN,1ZH				
	1.4 TSI RS	132		05.10	PR: 1LN,1ZH				
	1.6 i 16V	77		03.07	PR: 1LN,1ZH				
	1.6 TDI	55		04.10	PR: 1LN,1ZH				
	1.6 TDI	66		03.10	PR: 1LN,1ZH				
	1.6 TDI	77		03.10	PR: 1LN,1ZH				
1.9 TDI	77		03.07	PR: 1LN,1ZH					
	1.2	44		03.07	PR: 1KK	G1020755		20961 17,1 /Acc/S	LUC
	1.2	51		03.07	PR: 1KK				
	1.2 TDI	55		05.10	PR: 1KK				
	1.2 TSI	63		03.10	PR: 1KK				
	1.2 TSI	77		03.10	PR: 1KK				
	1.4 i 16V	63		03.07	PR: 1KK				
	1.4 TDI	51		03.07	PR: 1KK				
	1.4 TDI	59		03.07	PR: 1KK				
	1.4 TSI RS	132		05.10	PR: 1KK				
	1.6 i 16V	77		03.07	PR: 1KK				
	1.6 TDI	55		04.10	PR: 1KK				
	1.6 TDI	66		03.10	PR: 1KK				
	1.6 TDI	77		03.10	PR: 1KK				
1.9 TDI	77		03.07	PR: 1KK					
	1.2	44		03.07	PR: 1KT,1KV	G1020492		23554 17,1 /WD/S	LUC
	1.2	51		03.07	PR: 1KT,1KV				
	1.2 TDI	55		05.10	PR: 1KT,1KV				

<b>SKODA FABIA II (5J) (07-)</b>																	
	1.2 TSI	63		03.10		PR: 1KT,1KV		G1020492		23554 17,1 /WD/S	LUC						
	1.2 TSI	77		03.10		PR: 1KT,1KV											
	1.4 i 16V	63		03.07		PR: 1KT,1KV											
	1.4 TDI	51		03.07		PR: 1KT,1KV											
	1.4 TDI	59		03.07		PR: 1KT,1KV											
	1.4 TSI RS	132		05.10		PR: 1KT,1KV											
	1.6 i 16V	77		03.07		PR: 1KT,1KV											
	1.6 TDI	55		04.10		PR: 1KT,1KV											
	1.6 TDI	66		03.10		PR: 1KT,1KV											
1.6 TDI	77		03.10		PR: 1KT,1KV												
1.9 TDI	77		03.07		PR: 1KT,1KV												
	1.2	44		03.07	05.09	PR: 1KK		G2109123		230 9,0 7,0 +S +C							
	1.2	51		03.07	05.09	PR: 1KK											
	1.4 i 16V	63		03.07	05.09	PR: 1KK											
	1.4 TDI	51		03.07	05.09	PR: 1KK											
	1.4 TDI	59		03.07	05.09	PR: 1KK											
	1.6 i 16V	77		03.07	05.09	PR: 1KK											
	1.9 TDI	77		03.07	05.09	PR: 1KK											
	1.2	44		06.09		PR: 1KT,1KV,2EJ			G2109123			230 9,0 7,0 +S +C					
	1.2	51		06.09		PR: 1KT,1KV,2EJ											
1.2 TDI	55		05.10		PR: 1KT,1KV,2EJ												
1.2 TSI	63		03.10		PR: 1KT,1KV,2EJ												
1.2 TSI	77		03.10		PR: 1KT,1KV,2EJ												
1.4 i 16V	63		06.09		PR: 1KT,1KV,2EJ												
1.4 TDI	51		06.09		PR: 1KT,1KV,2EJ												
1.4 TDI	59		06.09		PR: 1KT,1KV,2EJ												
1.4 TSI RS	132		05.10		PR: 1KT,1KV,2EJ												
1.6 i 16V	77		06.09		PR: 1KT,1KV,2EJ												
1.6 TDI	55		04.10		PR: 1KT,1KV,2EJ												
1.6 TDI	66		03.10		PR: 1KT,1KV,2EJ												
1.6 TDI	77		03.10		PR: 1KT,1KV,2EJ												
1.9 TDI	77		06.09		PR: 1KT,1KV,2EJ												
<b>SKODA FAVORIT (781) (87-95)</b>																	
	135			04.94	12.95			G2113182		236 12,8 11,4 +C							
	136			04.94	12.95												
<b>SKODA FELICIA I (791/795) (95-97)</b>																	
	1.3 (135)			10.94	02.98			G2113182		236 12,8 11,4 +C							
	1.3 i (136)	50		10.94	02.98												
	1.6 i			08.95	02.98												
	1.9 D			10.96	02.98												
<b>SKODA FELICIA II (6U) (98-01)</b>																	
	1.3 i			03.98	08.01			G2113182		236 12,8 11,4 +C							
	1.6 i			03.98	08.01												
	1.9 D			03.98	08.01												
<b>SKODA FELICIA PICK-UP (797) (97-00)</b>																	
	1.3	40		06.97	12.00			G2113182		236 12,8 11,4 +C							
	1.3	50		06.97	12.00												
	1.6	55		06.97	12.99												
	1.9 D	47		06.97	12.00												
<b>SKODA FORMAN (785) (91-95)</b>																	
	1.3 i			04.94	12.95			G2113182		236 12,8 11,4 +C							
<b>SKODA OCTAVIA I (1U) (97-10)</b>																	
	1.4 i		1U-X-415000	04.99		PR: 1LQ,1LR,1LS,1ZM		G1020331		23130 19,7 +	VW						
	1.6 i		1U-X-415000	10.96		PR: 1LQ,1LR,1LS,1ZM											
	1.8 i 20V	92	1U-X-415000	10.96		PR: 1LQ,1LR,1LS,1ZM											
	1.8 i 20V Turbo	110	1U-X-415000	03.98		PR: 1LQ,1LR,1LS,1ZM											
	1.9 SDI		1U-X-415000	05.97		PR: 1LQ,1LR,1LS,1ZM											
	1.9 TDI	66	1U-X-415000	10.96		PR: 1LQ,1LR,1LS,1ZM											
	1.9 TDI	81	1U-X-415000	08.97		PR: 1LQ,1LR,1LS,1ZM											
	2.0 i		1U-X-415000	04.99		PR: 1LQ,1LR,1LS,1ZM											
	1.4 i		1U-Y-000001		06.10	PR: 1LQ,1LR,1LS,1ZM			G1020463				23131 19,7 +/Wl	VW			
	1.6 i		1U-Y-000001		06.10	PR: 1LQ,1LR,1LS,1ZM											
1.8 i 20V	92	1U-Y-000001		06.10	PR: 1LQ,1LR,1LS,1ZM												
1.8 i 20V Turbo	110	1U-Y-000001		06.10	PR: 1LQ,1LR,1LS,1ZM												
1.8 i 20V Turbo 4x4	110		05.01	06.10	PR: 1LQ,1LR,1LS,1ZM												
1.9 SDI		1U-Y-000001		06.10	PR: 1LQ,1LR,1LS,1ZM												
1.9 TDI	66	1U-Y-000001		06.10	PR: 1LQ,1LR,1LS,1ZM												
1.9 TDI	74		08.00	06.10	PR: 1LQ,1LR,1LS,1ZM												
1.9 TDI	81	1U-Y-000001		06.10	PR: 1LQ,1LR,1LS,1ZM												
1.9 TDI	96		01.03	06.10	PR: 1LQ,1LR,1LS,1ZM												
1.9 TDI 4x4			11.99	06.10	PR: 1LQ,1LR,1LS,1ZM												
2.0 i		1U-Y-000001		06.10	PR: 1LQ,1LR,1LS,1ZM												
2.0 i 4x4	85		05.01	06.10	PR: 1LQ,1LR,1LS,1ZM												
2.0 i 4x4	88		01.00	06.10	PR: 1LQ,1LR,1LS,1ZM												
1.4 i			04.99	06.10	PR: 1LN,1LE,1ZD,1ZE,1ZH		G1020379 G1020512		21911 20,3 + 23392 20,3 +/Wl	ATE ATE							
1.6 i			10.96	06.10	PR: 1LN,1LE,1ZD,1ZE,1ZH												
1.8 i 20V	92		10.96	06.10	PR: 1LN,1LE,1ZD,1ZE,1ZH												



**SKODA OCTAVIA I (1U) (97-10)**

















	1.8 i 20V Turbo	110		03.98	06.10	PR: 1LN,1LE,1ZD,1ZE,1ZH	G1020379 G1020512		21911 20,3 + 23392 20,3 +/Wl	ATE ATE
	1.8 i 20V Turbo 4x4	110		05.01	06.10	PR: 1LN,1LE,1ZD,1ZE,1ZH				
	1.9 SDI			05.97	06.10	PR: 1LN,1LE,1ZD,1ZE,1ZH				
	1.9 TDI	66		10.96	06.10	PR: 1LN,1LE,1ZD,1ZE,1ZH				
	1.9 TDI	74		08.00	06.10	PR: 1LN,1LE,1ZD,1ZE,1ZH				
	1.9 TDI	81		08.97	06.10	PR: 1LN,1LE,1ZD,1ZE,1ZH				
	1.9 TDI	96		01.03	06.10	PR: 1LN,1LE,1ZD,1ZE,1ZH				
	1.9 TDI 4x4			11.99	06.10	PR: 1LN,1LE,1ZD,1ZE,1ZH				
	2.0 i			04.99	06.10	PR: 1LN,1LE,1ZD,1ZE,1ZH				
	2.0 i 4x4	85		05.01	06.10	PR: 1LN,1LE,1ZD,1ZE,1ZH				
2.0 i 4x4	88		01.00	06.10	PR: 1LN,1LE,1ZD,1ZE,1ZH					
RS 1.8 T 20V	132		05.01	06.10	PR: 1ZN					
	1.4 i			04.99	06.10	PR: 1LQ	G2122151		256 22,0 19,0 V L +S +C	
	1.6 i			10.96	06.10	PR: 1LQ				
	1.8 i 20V	92		10.96	06.10	PR: 1LQ				
	1.8 i 20V Turbo	110		03.98	06.10	PR: 1LQ				
	1.8 i 20V Turbo 4x4	110		05.01	06.10	PR: 1LQ				
	1.9 SDI			05.97	06.10	PR: 1LQ				
	1.9 TDI	66		10.96	06.10	PR: 1LQ				
	1.9 TDI	74		08.00	06.10	PR: 1LQ				
	1.9 TDI	81		08.97	06.10	PR: 1LQ				
	1.9 TDI	96		01.03	06.10	PR: 1LQ				
1.9 TDI 4x4			11.99	06.10	PR: 1LQ					
2.0 i			04.99	06.10	PR: 1LQ					
2.0 i 4x4	85		05.01	06.10	PR: 1LQ					
2.0 i 4x4	88		01.00	06.10	PR: 1LQ					
	1.4 i			04.99	06.10	PR: 1LR,1LS,1ZM	G2122150		280 22,0 19,0 V L +S +C	
	1.6 i			10.96	06.10	PR: 1LR,1LS,1ZM				
	1.8 i 20V	92		10.96	06.10	PR: 1LR,1LS,1ZM				
	1.8 i 20V Turbo	110		03.98	06.10	PR: 1LR,1LS,1ZM				
	1.8 i 20V Turbo 4x4	110		05.01	06.10	PR: 1LR,1LS,1ZM				
	1.9 SDI			05.97	06.10	PR: 1LR,1LS,1ZM				
	1.9 TDI	66		10.96	06.10	PR: 1LR,1LS,1ZM				
	1.9 TDI	74		08.00	06.10	PR: 1LR,1LS,1ZM				
	1.9 TDI	81		08.97	06.10	PR: 1LR,1LS,1ZM				
	1.9 TDI	96		01.03	06.10	PR: 1LR,1LS,1ZM				
1.9 TDI 4x4			11.99	06.10	PR: 1LR,1LS,1ZM					
2.0 i			04.99	06.10	PR: 1LR,1LS,1ZM					
2.0 i 4x4	85		05.01	06.10	PR: 1LR,1LS,1ZM					
2.0 i 4x4	88		01.00	06.10	PR: 1LR,1LS,1ZM					
RS 1.8 T 20V	132		05.01	06.10	PR: 1ZN					
	1.6 i			10.96	06.10	PR: 1KK,1KS,1KP	G1020755		20961 17,1 /Acc/S	LUC
	1.8 i 20V	92		10.96	06.10	PR: 1KK,1KS,1KP				
	1.8 i 20V Turbo	110		03.98	06.10	PR: 1KK,1KS,1KP				
	1.8 i 20V Turbo 4x4	110		05.01	06.10	PR: 1KE				
	1.9 SDI			05.97	06.10	PR: 1KK,1KS,1KP				
	1.9 TDI	66		08.97	06.10	PR: 1KK,1KS,1KP				
	1.9 TDI	74		08.00	06.10	PR: 1KK,1KS,1KP				
	1.9 TDI	81		08.97	06.10	PR: 1KK,1KS,1KP				
	1.9 TDI	96		01.03	06.10	PR: 1KK,1KS,1KP				
	1.9 TDI 4x4			11.99	06.10	PR: 1KE				
2.0 i			04.99	06.10	PR: 1KK,1KS,1KP					
2.0 i 4x4	85		05.01	06.10	PR: 1KE					
2.0 i 4x4	88		01.00	06.10	PR: 1KE					
RS 1.8 T 20V	132		01.03	06.10	PR: 2ED					
	1.8 i 20V	92	1U-W-129 999	10.96	06.10	PR: 1KK,1KS	G2109123		230 9,0 7,0 +S +C	
	1.8 i 20V Turbo	110	1U-W-129 999	03.98	06.10	PR: 1KK,1KS				
	1.9 SDI		1U-W-129 999	05.97	06.10	PR: 1KK,1KS				
	1.9 TDI	81	1U-W-129 999	08.97	06.10	PR: 1KK,1KS				
	1.6 i			10.96	06.10	PR: 1KP				
1.8 i 20V	92	1U-W-130 000		06.10	PR: 1KP					
1.8 i 20V Turbo	110	1U-W-130 000		06.10	PR: 1KP					
1.9 SDI		1U-W-130 000		06.10	PR: 1KP					
1.9 TDI	66	1U-W-130 000		06.10	PR: 1KP					
1.9 TDI	74		08.00	06.10	PR: 1KP					
1.9 TDI	81		08.97	06.10	PR: 1KP					
1.9 TDI	96		01.03	06.10	PR: 1KP					
2.0 i			04.99	06.10	PR: 1KP					
1.8 i 20V Turbo 4x4	110		05.01	06.10	PR: 1KE					
1.9 TDI 4x4			11.99	06.10	PR: 1KE					
2.0 i 4x4	85		05.01	06.10	PR: 1KE					
2.0 i 4x4	88		01.00	06.10	PR: 1KE					
RS 1.8 T 20V	132		01.00	06.10	PR: 1KE					





**SKODA OCTAVIA II (1Z) (04-13)**

	1.2 TSI	77		02.10	01.13	PR: 1KD	G1020492		23554 17,1 /WD/S	LUC
	1.4 i 16V			06.04	01.13	PR: 1KD				
	1.4 TSI	90		11.08	01.13	PR: 1KD				
	1.6	75		09.09	01.13	PR: 1KD				
	1.6 FSI	85		06.04	01.13	PR: 1KD				
	1.6 i 16V	75		06.04	01.13	PR: 1KD				
	1.6 TDI	77		06.09	01.13	PR: 1KD				
	1.8 TSI			06.07	01.13	PR: 1KD				
	1.9 TDI	77		06.04	01.13	PR: 1KD				
	2.0 FSI	110		11.04	01.13	PR: 1KD				
	2.0 TDI	81		03.10	01.13	PR: 1KD				
	2.0 TDI	100		06.04	01.13	PR: 1KD				
2.0 TDI	103		06.04	01.13	PR: 1KD					
2.0 TDi 4x4	81		05.11	01.13	PR: 1KD					
	1.2 TSI	77		02.10	01.13	PR: 1KF	G1020682		23914 17,1 /WD/Acc/S	LUC
	1.4 i 16V			06.04	01.13	PR: 1KF				
	1.4 TSI	90		11.08	01.13	PR: 1KF				
	1.6	75		09.09	01.13	PR: 1KF				
	1.6 FSI	85		06.04	01.13	PR: 1KF				
	1.6 i 16V	75		06.04	01.13	PR: 1KF				
	1.6 TDI	77		06.09	01.13	PR: 1KF				
	1.6 TDI 4x4	77		06.09	01.13	PR: 1KF				
	1.8 TSI			06.07	01.13	PR: 1KF				
	1.8 TSI 4x4			11.08	01.13	PR: 1KF				
	1.9 TDI	77		06.04	01.13	PR: 1KF				
	1.9 TDI 4x4	77		11.04	01.13	PR: 1KF				
	2.0 FSI	110		11.04	01.13	PR: 1KF				
	2.0 FSI 4x4	110		11.04	01.13	PR: 1KF				
	2.0 RS	147		10.05	01.13	PR: 1KP				
	2.0 TDI	81		03.10	01.13	PR: 1KF				
	2.0 TDI	100		06.04	01.13	PR: 1KF				
	2.0 TDI	103		06.04	01.13	PR: 1KF				
	2.0 TDi 4x4	81		05.11	01.13	PR: 1KF				
	2.0 TDi 4x4	103		07.06	01.13	PR: 1KF				
2.0 TDI RS	125		04.06	01.13	PR: 1KP					
	1.2 TSI	77		02.10	01.13	PR: 1KD	G2110277		253 10,0 8,0 +S +C	
	1.4 i 16V			06.04	01.13	PR: 1KD				
	1.4 TSI	90		11.08	01.13	PR: 1KD				
	1.6	75		09.09	01.13	PR: 1KD				
	1.6 FSI	85		06.04	01.13	PR: 1KD				
	1.6 i 16V	75		06.04	01.13	PR: 1KD				
	1.6 TDI	77		06.09	01.13	PR: 1KD				
	1.8 TSI			06.07	01.13	PR: 1KD				
	1.9 TDI	77		06.04	01.13	PR: 1KD				
	2.0 FSI	110		11.04	01.13	PR: 1KD				
	2.0 TDI	81		03.10	01.13	PR: 1KD				
	2.0 TDI	100		06.04	01.13	PR: 1KD				
2.0 TDI	103		06.04	01.13	PR: 1KD					
2.0 TDi 4x4	81		05.11	01.13	PR: 1KD					
	1.2 TSI	77		02.10	01.13	PR: 1KS,1KT	G2110356		272 9,7 8,0 +S +C	
	1.4 i 16V			06.04	01.13	PR: 1KS,1KT				
	1.4 TSI	90		11.08	01.13	PR: 1KS,1KT				
	1.6	75		09.09	01.13	PR: 1KS,1KT				
	1.6 FSI	85		06.04	01.13	PR: 1KS,1KT				
	1.6 i 16V	75		06.04	01.13	PR: 1KS,1KT				
	1.6 TDI	77		06.09	01.13	PR: 1KS,1KT				
	1.6 TDI 4x4	77		06.09	01.13	PR: 1KS,1KT				
	1.8 TSI			06.07	01.13	PR: 1KS,1KT				
	1.8 TSI 4x4			11.08	01.13	PR: 1KS,1KT				
	1.9 TDI	77		06.04	01.13	PR: 1KS,1KT				
	1.9 TDI 4x4	77		11.04	01.13	PR: 1KS,1KT				
2.0 FSI	110		11.04	01.13	PR: 1KS,1KT					
2.0 FSI 4x4	110		11.04	01.13	PR: 1KS,1KT					
2.0 TDI	81		03.10	01.13	PR: 1KS,1KT					
2.0 TDI	100		06.04	01.13	PR: 1KS,1KT					
2.0 TDI	103		06.04	01.13	PR: 1KS,1KT					
2.0 TDi 4x4	81		05.11	01.13	PR: 1KS,1KT					
2.0 TDi 4x4	103		07.06	01.13	PR: 1KS,1KT					
	1.2 TSI	77		02.10	01.13	PR: 1KF	G2112158		256 12,0 10,0 +C	
	1.4 i 16V			06.04	01.13	PR: 1KF				
	1.4 TSI	90		11.08	01.13	PR: 1KF				
	1.6	75		09.09	01.13	PR: 1KF				
	1.6 FSI	85		06.04	01.13	PR: 1KF				
	1.6 i 16V	75		06.04	01.13	PR: 1KF				
	1.6 TDI	77		06.09	01.13	PR: 1KF				
	1.6 TDI 4x4	77		06.09	01.13	PR: 1KF				
	1.8 TSI			06.07	01.13	PR: 1KF				
	1.8 TSI 4x4			11.08	01.13	PR: 1KF				
	1.9 TDI	77		06.04	01.13	PR: 1KF				
	1.9 TDI 4x4	77		11.04	01.13	PR: 1KF				
2.0 FSI	110		11.04	01.13	PR: 1KF					
2.0 FSI 4x4	110		11.04	01.13	PR: 1KF					
2.0 TDI	81		11.04	01.13	PR: 1KF					
2.0 TDI	100		03.10	01.13	PR: 1KF					
2.0 TDI	100		06.04	01.13	PR: 1KF					
2.0 TDI	103		06.04	01.13	PR: 1KF					
2.0 TDi 4x4	81		05.11	01.13	PR: 1KF					
2.0 TDi 4x4	103		07.06	01.13	PR: 1KF					

							
<b>SKODA OCTAVIA II (1Z) (04-13)</b>							
	2.0 RS 2.0 TDI RS	147 125	10.05 04.06	01.13 01.13	PR: 1KP PR: 1KP	G2112169	282 12,0 10,0 +S +C
<b>SKODA OCTAVIA III (5E) (13-)</b>							
	1.2 TSI 1.2 TSI 1.4 TSI 1.6 TDI 1.6 TDI 1.6 TDI 1.6 TDI 4x4 1.8 TSI 1.8 TSI 4x4 2.0 TDI 2.0 TDI 2.0 TDI 2.0 TDI 4x4 2.0 TSI RS	63 77 103 66 77 81 77 132 132 105 110 135 110 162	02.13 02.13 11.12 02.13 02.13 02.13 11.12 11.12 11.12 11.12 02.13 05.13 11.12 05.13	PR: 1ZE PR: 1ZE PR: 1ZE PR: 1ZE PR: 1ZE PR: 1ZE PR: 1ZE PR: 1ZE PR: 1ZE PR: 1ZE PR: 1ZE PR: 1ZE PR: 1ZE PR: 1ZE	G2125145	288 25,0 22,0 V L +S +C	
	1.2 TSI 1.2 TSI 1.4 TSI 1.6 TDI 1.6 TDI 1.6 TDI 1.6 TDI 4x4 1.8 TSI 1.8 TSI 4x4 2.0 TDI 2.0 TDI 2.0 TDI 4x4 2.0 TSI RS	63 77 103 66 77 81 77 132 132 105 110 135 110 162	02.13 02.13 11.12 02.13 02.13 02.13 11.12 11.12 11.12 11.12 02.13 05.13 11.12 05.13	PR: 1ZA,1ZB PR: 1ZA,1ZB PR: 1ZA,1ZB PR: 1ZA,1ZB PR: 1ZA,1ZB PR: 1ZA,1ZB PR: 1ZA,1ZB PR: 1ZA,1ZB PR: 1ZA,1ZB PR: 1ZA,1ZB PR: 1ZA,1ZB PR: 1ZA,1ZB PR: 1ZA,1ZB PR: 1ZA,1ZB	G2125158	312 25,0 22,0 V L +S +C	
	1.2 TSI 1.2 TSI 1.4 TSI 1.6 TDI 1.6 TDI 1.6 TDI 1.6 TDI 4x4 1.8 TSI 1.8 TSI 4x4 2.0 TDI 2.0 TDI 2.0 TDI 4x4 2.0 TSI RS	63 77 103 66 77 81 77 132 132 105 110 135 110 162	02.13 02.13 11.12 02.13 02.13 02.13 11.12 11.12 11.12 11.12 02.13 05.13 11.12 05.13	PR: 1KD PR: 1KD PR: 1KD PR: 1KD PR: 1KD PR: 1KD PR: 1KD PR: 1KD PR: 1KD PR: 1KD PR: 1KD PR: 1KD PR: 1KD	G2110277	253 10,0 8,0 +S +C	
	1.2 TSI 1.2 TSI 1.4 TSI 1.6 TDI 1.6 TDI 1.6 TDI 1.6 TDI 4x4 1.8 TSI 1.8 TSI 4x4 2.0 TDI 2.0 TDI 2.0 TDI 4x4 2.0 TSI RS	63 77 103 66 77 81 77 132 132 105 110 135 110 162	02.13 02.13 11.12 02.13 02.13 02.13 11.12 11.12 11.12 11.12 02.13 05.13 11.12 05.13	PR: 1KS,1KT PR: 1KS,1KT PR: 1KS,1KT PR: 1KS,1KT PR: 1KS,1KT PR: 1KS,1KT PR: 1KS,1KT PR: 1KS,1KT PR: 1KS,1KT PR: 1KS,1KT PR: 1KS,1KT PR: 1KS,1KT PR: 1KS,1KT	G2110356	272 9,7 8,0 +S +C	
<b>SKODA PICK-UP (93-95)</b>							
	1.3		04.94	12.95		G2113182	236 12,8 11,4 +C
<b>SKODA RAPID / RAPID Spaceback (12-)</b>							
	1.2 1.2 TSI 1.2 TSI 1.4 TSI 1.6 1.6 TDI 1.6 TDI	55 63 77 90 77 66 77	10.12 10.12 10.12 10.12 07.13 08.13 10.12	PR: 1ZG PR: 1ZG PR: 1ZG PR: 1ZG PR: 1ZG PR: 1ZG PR: 1ZG	G1020331	23130 19,7 +	VW
	1.2 1.2 TSI 1.2 TSI 1.4 TSI 1.6 1.6 TDI 1.6 TDI	55 63 77 90 77 66 77	10.12 10.12 10.12 10.12 07.13 08.13 10.12	PR: 1ZC PR: 1ZC PR: 1ZC PR: 1ZC PR: 1ZC PR: 1ZC PR: 1ZC	G1020680	23587 20,6 +/Wl	ATE
	1.2 1.2 TSI 1.2 TSI 1.4 TSI	55 63 77 90	10.12 10.12 10.12 10.12	PR: 1ZG PR: 1ZG PR: 1ZG PR: 1ZG	G2122151	256 22,0 19,0 V L +S +C	



**SKODA RAPID / RAPID Spaceback (12-)**

	1.6	77		07.13	PR: 1ZG	G2122151		256 22,0 19,0 V L +S +C
	1.6 TDI	66		08.13	PR: 1ZG			
	1.6 TDI	77		10.12	PR: 1ZG			
	1.2	55		10.12	PR: 1ZC	G2125113		288 25,0 22,0 V L +S +C
	1.2 TSI	63		10.12	PR: 1ZC			
	1.2 TSI	77		10.12	PR: 1ZC			
	1.4 TSI	90		10.12	PR: 1ZC			
	1.6	77		07.13	PR: 1ZC			
1.6 TDI	66		08.13	PR: 1ZC				
1.6 TDI	77		10.12	PR: 1ZC				
	1.2	55		10.12	PR: 1KT	G1020492		23554 17,1 /WD/S LUC
	1.2 TSI	63		10.12	PR: 1KT			
	1.2 TSI	77		10.12	PR: 1KT			
	1.4 TSI	90		10.12	PR: 1KT			
	1.6	77		07.13	PR: 1KT			
	1.6 TDI	66		08.13	PR: 1KT			
	1.6 TDI	77		10.12	PR: 1KT			
	1.2	55		10.12	PR: 1KT	G2109123		230 9,0 7,0 +S +C
	1.2 TSI	63		10.12	PR: 1KT			
	1.2 TSI	77		10.12	PR: 1KT			
	1.4 TSI	90		10.12	PR: 1KT			
	1.6	77		07.13	PR: 1KT			
	1.6 TDI	66		08.13	PR: 1KT			
	1.6 TDI	77		10.12	PR: 1KT			

**SKODA ROOMSTER (5J) (06-)**

	1.0 i	53		07.06	PR: 1LQ,1LR,1ZG	G1020331 G1020463		23130 19,7 + 23131 19,7 +/W/ VW VW	
	1.2			07.06	PR: 1LQ,1LR,1ZG				
	1.2 TDI	55		03.10	PR: 1LQ,1LR,1ZG				
	1.2 TSI	63		03.10	PR: 1LQ,1LR,1ZG				
	1.2 TSI	77		03.10	PR: 1LQ,1LR,1ZG				
	1.4	63		07.06	PR: 1LQ,1LR,1ZG				
	1.4 TDI	51		07.06	PR: 1LQ,1LR,1ZG				
	1.4 TDI	59		07.06	PR: 1LQ,1LR,1ZG				
	1.6	77		07.06	PR: 1LQ,1LR,1ZG				
	1.6 TDI	66		03.10	PR: 1LQ,1LR,1ZG				
	1.6 TDI	77		03.10	PR: 1LQ,1LR,1ZG				
	1.9 TDI			07.06	PR: 1LQ,1LR,1ZG				
	1.0 i	53		07.06	PR: 1LN	G1020732 G1020733		23581 18,8 /S 23843 18,8 +/W/S LUC LUC	
	1.2			07.06	PR: 1LN				
1.2 TDI	55		03.10	PR: 1LN					
1.2 TSI	63		03.10	PR: 1LN					
1.2 TSI	77		03.10	PR: 1LN					
1.4	63		07.06	PR: 1LN					
1.4 TDI	51		07.06	PR: 1LN					
1.4 TDI	59		07.06	PR: 1LN					
1.6	77		07.06	PR: 1LN					
1.6 TDI	66		03.10	PR: 1LN					
1.6 TDI	77		03.10	PR: 1LN					
1.9 TDI			07.06	PR: 1LN					
	1.0 i	53		07.06	PR: 1ZC	G1020680		23587 20,6 +/W/ ATE	
	1.2			07.06	PR: 1ZC				
	1.2 TDI	55		03.10	PR: 1ZC				
	1.2 TSI	63		03.10	PR: 1ZC				
	1.2 TSI	77		03.10	PR: 1ZC				
	1.4	63		07.06	PR: 1ZC				
	1.4 TDI	51		07.06	PR: 1ZC				
	1.4 TDI	59		07.06	PR: 1ZC				
	1.6	77		07.06	PR: 1ZC				
	1.6 TDI	66		03.10	PR: 1ZC				
	1.6 TDI	77		03.10	PR: 1ZC				
	1.9 TDI			07.06	PR: 1ZC				
		1.0 i	53		07.06	PR: 1LQ,1LR,1ZG	G2122151		256 22,0 19,0 V L +S +C
		1.2			07.06	PR: 1LQ,1LR,1ZG			
1.2 TDI		55		03.10	PR: 1LQ,1LR,1ZG				
1.2 TSI		63		03.10	PR: 1LQ,1LR,1ZG				
1.2 TSI		77		03.10	PR: 1LQ,1LR,1ZG				
1.4		63		07.06	PR: 1LQ,1LR,1ZG				
1.4 TDI		51		07.06	PR: 1LQ,1LR,1ZG				
1.4 TDI		59		07.06	PR: 1LQ,1LR,1ZG				
1.6		77		07.06	PR: 1LQ,1LR,1ZG				
1.6 TDI		66		03.10	PR: 1LQ,1LR,1ZG				
1.6 TDI		77		03.10	PR: 1LQ,1LR,1ZG				
1.9 TDI				07.06	PR: 1LQ,1LR,1ZG				
1.0 i		53		07.06	PR: 1LN,1ZC	G2125113		288 25,0 22,0 V L +S +C	
1.2				07.06	PR: 1LN,1ZC				
1.2 TDI	55		03.10	PR: 1LN,1ZC					
1.2 TSI	63		03.10	PR: 1LN,1ZC					
1.2 TSI	77		03.10	PR: 1LN,1ZC					
1.4	63		07.06	PR: 1LN,1ZC					
1.4 TDI	51		07.06	PR: 1LN,1ZC					
1.4 TDI	59		07.06	PR: 1LN,1ZC					
1.6	77		07.06	PR: 1LN,1ZC					
1.6 TDI	66		03.10	PR: 1LN,1ZC					
1.6 TDI	77		03.10	PR: 1LN,1ZC					
1.9 TDI			07.06	PR: 1LN,1ZC					



**SKODA ROOMSTER (5J) (06-)**

	1.0 i	53		07.06	PR: 1KK	G1020755		20961 17,1 /Acc/S	LUC
	1.2			07.06	PR: 1KK				
	1.2 TDI	55		03.10	PR: 1KK				
	1.2 TSI	63		03.10	PR: 1KK				
	1.2 TSI	77		03.10	PR: 1KK				
	1.4	63		07.06	PR: 1KK				
	1.4 TDI	51		07.06	PR: 1KK				
	1.4 TDI	59		07.06	PR: 1KK				
	1.6	77		07.06	PR: 1KK				
	1.6 TDI	66		03.10	PR: 1KK				
1.6 TDI	77		03.10	PR: 1KK					
1.9 TDI			07.06	PR: 1KK					
	1.0 i	53		07.06	PR: 1KT	G1020492		23554 17,1 /WD/S	LUC
	1.2			07.06	PR: 1KT				
	1.2 TDI	55		03.10	PR: 1KT				
	1.2 TSI	63		03.10	PR: 1KT				
	1.2 TSI	77		03.10	PR: 1KT				
	1.4	63		07.06	PR: 1KT				
	1.4 TDI	51		07.06	PR: 1KT				
	1.4 TDI	59		07.06	PR: 1KT				
	1.6	77		07.06	PR: 1KT				
	1.6 TDI	66		03.10	PR: 1KT				
1.6 TDI	77		03.10	PR: 1KT					
1.9 TDI			07.06	PR: 1KT					
	1.0 i	53		07.06	PR: 1KK	G2109123		230 9,0 7,0 +S +C	
	1.2			07.06	PR: 1KK				
	1.2 TDI	55		03.10	PR: 1KK				
	1.2 TSI	63		03.10	PR: 1KK				
	1.2 TSI	77		03.10	PR: 1KK				
	1.4	63		07.06	PR: 1KK				
	1.4 TDI	51		07.06	PR: 1KK				
	1.4 TDI	59		07.06	PR: 1KK				
	1.6	77		07.06	PR: 1KK				
	1.6 TDI	66		03.10	PR: 1KK				
1.6 TDI	77		03.10	PR: 1KK					
1.9 TDI			07.06	PR: 1KK					
	1.0 i	53		07.06	PR: 1KT	G2109123		230 9,0 7,0 +S +C	
	1.2			07.06	PR: 1KT				
	1.2 TDI	55		03.10	PR: 1KT				
	1.2 TSI	63		03.10	PR: 1KT				
	1.2 TSI	77		03.10	PR: 1KT				
	1.4	63		07.06	PR: 1KT				
	1.4 TDI	51		07.06	PR: 1KT				
	1.4 TDI	59		07.06	PR: 1KT				
	1.6	77		07.06	PR: 1KT				
	1.6 TDI	66		03.10	PR: 1KT				
1.6 TDI	77		03.10	PR: 1KT					
1.9 TDI			07.06	PR: 1KT					

**SKODA SUPERB I (02-08)**

	1.8 i 20V Turbo	110		12.01	02.08	G1020313		23018 20,3 +/WI	ATE				
	1.9 TDI	74		08.02	12.07								
	1.9 TDI	77		10.05	12.07								
	1.9 TDI	85		01.07	12.07								
	1.9 TDI	96		12.01	12.07								
	2.0 i	85		12.01	02.08								
	2.0 TDI	103		10.05	12.07								
	2.5 TDI	114		12.01	12.07								
	2.5 TDI	120		06.03	12.07								
	2.8 i V6	142		12.01	12.07								
	1.8 i 20V Turbo	110	3U-39046708	12.01		G2125105		288 25,0 23,0 V L +C					
	1.9 TDI	74	3U-39046708	08.02									
	1.9 TDI	96	3U-39046708	12.01									
	2.0 i	85	3U-39046708	12.01									
	1.8 i 20V Turbo	110	3U-39046709	3U-69101369						G2125171		288 25,0 23,0 V L +C	
	1.9 TDI	74	3U-39046709	3U-69101369									
	1.9 TDI	77		3U-69101369	10.05								
	1.9 TDI	96	3U-39046709	3U-69101369									
	2.0 i	85	3U-39046709	3U-69101369									
	1.8 i 20V Turbo	110	3U-69101370		02.08								
1.9 TDI	74	3U-69101370		12.07									
1.9 TDI	77	3U-69101370		12.07									
1.9 TDI	85		01.07	12.07									
1.9 TDI	96	3U-69101370		12.07									
2.0 i	85	3U-69101370		02.08									
2.0 TDI	103		3U-39043704	10.05	G2125137		312 25,0 23,0 V L +C						
2.5 TDI	114		3U-39043704	12.01									
2.5 TDI	120		3U-39043704	06.03									
2.8 i V6	142		3U-39043704	12.01									
2.0 TDI	103	3U-69100011		12.07					G2125158		312 25,0 22,0 V L +S +C		
2.5 TDI	114	3U-69100011		12.07									
2.5 TDI	120	3U-69100011		12.07									
2.8 i V6	142	3U-69100011		12.07									



















**SKODA SUPERB I (02-08)**

	1.8 i 20V Turbo	110		12.01	02.08	G1020492		23554 17,1 /WD/S	LUC
	1.9 TDI	74		08.02	12.07				
	1.9 TDI	77		10.05	12.07				
	1.9 TDI	85		01.07	12.07				
	1.9 TDI	96		12.01	12.07				
	2.0 i	85		12.01	02.08				
	2.0 TDI	103		10.05	12.07				
	2.5 TDI	114		12.01	12.07				
	2.5 TDI	120		06.03	12.07				
	2.8 i V6	142		12.01	12.07				
	1.8 i 20V Turbo	110		12.01	02.08	G2110201		245 10,0 8,0 +C	
	1.9 TDI	74		08.02	12.07				
	1.9 TDI	77		10.05	12.07				
	1.9 TDI	85		01.07	12.07				
	1.9 TDI	96		12.01	12.07				
	2.0 i	85		12.01	02.08				
	2.0 TDI	103		10.05	12.07				
	2.5 TDI	114		12.01	12.07				
	2.5 TDI	120		06.03	12.07				
	2.8 i V6	142		12.01	12.07				

**SKODA SUPERB II (08-)**

	1.4 TSI	92		08.08		G1020680		23587 20,6 +/Wl	ATE
	1.4 TSI	103		08.08	PR: 1ZE,1LJ,1ZA				
	1.6 i 16V	77		08.08	PR: 1ZE,1LJ,1ZA				
	1.6 TDI	77		09.10	PR: 1ZE,1LJ,1ZA				
	1.8 TFSI			08.08	PR: 1ZE,1LJ,1ZA				
	1.8 TFSI 4x4			10.08	PR: 1ZE,1LJ,1ZA				
	1.9 TDI	77		08.08	PR: 1ZE,1LJ,1ZA				
	2.0 TDI	103		08.08	PR: 1ZE,1LJ,1ZA				
	2.0 TDI 4x4	125		08.08	PR: 1ZE,1LJ,1ZA				
	2.0 TSI	147		05.10	PR: 1ZE,1LJ,1ZA				
3.6 FSI V6 4x4	191		11.08	PR: 1ZE,1LJ,1ZA					
	1.4 TSI	92		08.08		G1020753		23801 20,3 +/Wl	ATE
	1.4 TSI	103		08.08	PR: 1LK				
	1.6 i 16V	77		08.08	PR: 1LK				
	1.6 TDI	77		09.10	PR: 1LK				
	1.8 TFSI			08.08	PR: 1LK				
	1.8 TFSI 4x4			10.08	PR: 1LK				
	1.9 TDI	77		08.08	PR: 1LK				
	2.0 TDI	103		08.08	PR: 1LK				
	2.0 TDI 4x4	125		08.08	PR: 1LK				
	2.0 TSI	147		05.10	PR: 1LK				
3.6 FSI V6 4x4	191		11.08	PR: 1LK					
	1.4 TSI	92		08.08		G2125145		288 25,0 22,0 V L +S +C	
	1.4 TSI	103		08.08	PR: 1ZE				
	1.6 i 16V	77		08.08	PR: 1ZE				
	1.6 TDI	77		09.10	PR: 1ZE				
	1.8 TFSI			08.08	PR: 1ZE				
	1.8 TFSI 4x4			10.08	PR: 1ZE				
	1.9 TDI	77		08.08	PR: 1ZE				
	2.0 TDI	103		08.08	PR: 1ZE				
	2.0 TDI 4x4	125		08.08	PR: 1ZE				
	2.0 TSI	147		05.10	PR: 1ZE				
3.6 FSI V6 4x4	191		11.08	PR: 1ZE					
	1.4 TSI	92		08.08		G2125158		312 25,0 22,0 V L +S +C	
	1.4 TSI	103		08.08	PR: 1LJ,1ZA				
	1.6 i 16V	77		08.08	PR: 1LJ,1ZA				
	1.6 TDI	77		09.10	PR: 1LJ,1ZA				
	1.8 TFSI			08.08	PR: 1LJ,1ZA				
	1.8 TFSI 4x4			10.08	PR: 1LJ,1ZA				
	1.9 TDI	77		08.08	PR: 1LJ,1ZA				
	2.0 TDI	103		08.08	PR: 1LJ,1ZA				
	2.0 TDI 4x4	125		08.08	PR: 1LJ,1ZA				
	2.0 TSI	147		05.10	PR: 1LJ,1ZA				
3.6 FSI V6 4x4	191		11.08	PR: 1LJ,1ZA					
	1.4 TSI	92		08.08		G2130115		345 30,0 27,0 V L +C	
	1.4 TSI	103		08.08	PR: 1LK				
	1.6 i 16V	77		08.08	PR: 1LK				
	1.6 TDI	77		09.10	PR: 1LK				
	1.8 TFSI			08.08	PR: 1LK				
	1.8 TFSI 4x4			10.08	PR: 1LK				
	1.9 TDI	77		08.08	PR: 1LK				
	2.0 TDI	103		08.08	PR: 1LK				
	2.0 TDI 4x4	125		08.08	PR: 1LK				
	2.0 TSI	147		05.10	PR: 1LK				
3.6 FSI V6 4x4	191		11.08	PR: 1LK					
	1.4 TSI	92		08.08		G1020682		23914 17,1 /WD/Acc/S	LUC
	1.4 TSI	103		08.08	PR: 1KF,1KJ				
	1.6 i 16V	77		08.08	PR: 1KF,1KJ				
	1.6 TDI	77		09.10	PR: 1KF,1KJ				
	1.8 TFSI			08.08	PR: 1KF,1KJ				

								
<b>SKODA SUPERB II (08-)</b>								
	1.9 TDI	77	08.08	PR: 1KF,1KJ	G1020682			23914 17,1 /WD/Acc/S LUC
	2.0 TDI	103	08.08	PR: 1KF,1KJ				
	2.0 TDI	125	08.08	PR: 1KF,1KJ				
	2.0 TSI	147	05.10	PR: 1KF,1KJ				
	1.8 TFSI 4x4		10.08	PR: 2EA				
	2.0 TDI 4x4		10.08	PR: 2EA	G1020682			23914 17,1 /WD/Acc/S LUC
	3.6 FSI V6 4x4	191	11.08	PR: 2EA				
	1.4 TSI	92	08.08	PR: 1KF	G2112158			256 12,0 10,0 +C
	1.4 TSI	103	08.08	PR: 1KF				
	1.6 i 16V	77	08.08	PR: 1KF				
	1.6 TDI	77	09.10	PR: 1KF				
	1.8 TFSI		08.08	PR: 1KF				
	1.9 TDI	77	08.08	PR: 1KF				
	2.0 TDI	103	08.08	PR: 1KF				
	2.0 TDI	125	08.08	PR: 1KF				
	2.0 TSI	147	05.10	PR: 1KF				
	1.4 TSI	92	08.08	PR: 1KJ	G2112169			282 12,0 10,0 +S +C
	1.4 TSI	103	08.08	PR: 1KJ				
	1.6 i 16V	77	08.08	PR: 1KJ				
	1.6 TDI	77	09.10	PR: 1KJ				
	1.8 TFSI		08.08	PR: 1KJ				
	1.9 TDI	77	08.08	PR: 1KJ				
	2.0 TDI	103	08.08	PR: 1KJ				
	2.0 TDI	125	08.08	PR: 1KJ				
	2.0 TSI	147	05.10	PR: 1KJ				
	1.4 TSI	92	08.08	PR: 1KS	G2110356			272 9,7 8,0 +S +C
	1.4 TSI	103	08.08	PR: 1KS				
	1.6 i 16V	77	08.08	PR: 1KS				
	1.6 TDI	77	09.10	PR: 1KS				
	1.8 TFSI		08.08	PR: 1KS				
	1.8 TFSI 4x4		10.08	PR: 1KS				
	1.9 TDI	77	08.08	PR: 1KS				
	2.0 TDI	103	08.08	PR: 1KS				
	2.0 TDI	125	08.08	PR: 1KS				
	2.0 TDI 4x4		10.08	PR: 1KS				
2.0 TSI	147	05.10	PR: 1KS					
3.6 FSI V6 4x4	191	11.08	PR: 1KS					
<b>SKODA SUPERB Estate (09-)</b>								
	1.4 TSI	92	11.09	PR: 1LK	G1020753			23801 20,3 +/WI ATE
	1.6 TDI	77	09.10	PR: 1LK				
	1.8 TSI		11.09	PR: 1LK				
	1.8 TSI 4x4		11.09	PR: 1LK				
	1.9 TDI	77	10.09	PR: 1LK				
	2.0 TDI	103	11.09	PR: 1LK				
	2.0 TDI	125	11.09	PR: 1LK				
	2.0 TDI 4x4	125	11.09	PR: 1LK				
	2.0 TSI	147	05.10	PR: 1LK				
	3.6 V6 4x4	191	11.09	PR: 1LK				
	1.4 TSI	92	11.09	PR: 1LJ,1ZA,1ZE	G1020680			23587 20,6 +/WI ATE
	1.6 TDI	77	09.10	PR: 1LJ,1ZA,1ZE				
	1.8 TSI		11.09	PR: 1LJ,1ZA,1ZE				
	1.8 TSI 4x4		11.09	PR: 1LJ,1ZA,1ZE				
	1.9 TDI	77	10.09	PR: 1LJ,1ZA,1ZE				
	2.0 TDI	103	11.09	PR: 1LJ,1ZA,1ZE				
	2.0 TDI	125	11.09	PR: 1LJ,1ZA,1ZE				
	2.0 TDI 4x4	125	11.09	PR: 1LJ,1ZA,1ZE				
	2.0 TSI	147	05.10	PR: 1LJ,1ZA,1ZE				
	3.6 V6 4x4	191	11.09	PR: 1LJ,1ZA,1ZE				
	1.4 TSI	92	11.09	PR: 1LK	G2130115			345 30,0 27,0 V L +C
	1.6 TDI	77	09.10	PR: 1LK				
	1.8 TSI		11.09	PR: 1LK				
	1.8 TSI 4x4		11.09	PR: 1LK				
	1.9 TDI	77	10.09	PR: 1LK				
	2.0 TDI	103	11.09	PR: 1LK				
	2.0 TDI	125	11.09	PR: 1LK				
	2.0 TDI 4x4	125	11.09	PR: 1LK				
	2.0 TSI	147	05.10	PR: 1LK				
	3.6 V6 4x4	191	11.09	PR: 1LK				
	1.4 TSI	92	11.09	PR: 1ZE	G2125145			288 25,0 22,0 V L +S +C
	1.6 TDI	77	09.10	PR: 1ZE				
	1.8 TSI		11.09	PR: 1ZE				
	1.8 TSI 4x4		11.09	PR: 1ZE				
	1.9 TDI	77	10.09	PR: 1ZE				
	2.0 TDI	103	11.09	PR: 1ZE				
	2.0 TDI	125	11.09	PR: 1ZE				
	2.0 TDI 4x4	125	11.09	PR: 1ZE				
	2.0 TSI	147	05.10	PR: 1ZE				
	3.6 V6 4x4	191	11.09	PR: 1ZE				
	1.4 TSI	92	11.09	PR: 1LJ,1ZA	G2125158			312 25,0 22,0 V L +S +C
	1.6 TDI	77	09.10	PR: 1LJ,1ZA				
	1.8 TSI		11.09	PR: 1LJ,1ZA				
	1.8 TSI 4x4		11.09	PR: 1LJ,1ZA				
	1.9 TDI	77	10.09	PR: 1LJ,1ZA				
	2.0 TDI	103	11.09	PR: 1LJ,1ZA				
2.0 TDI	125	11.09	PR: 1LJ,1ZA					











































**SKODA SUPERB Estate (09-)**























	2.0 TDI 4x4	125		11.09	PR: 1LJ,1ZA	G2125158		312 25,0 22,0 V L +S +C					
	2.0 TSI	147		05.10	PR: 1LJ,1ZA								
	3.6 V6 4x4	191		11.09	PR: 1LJ,1ZA								
	1.4 TSI	92		11.09	PR: 1KF,1KJ	G1020682		23914 17,1 /WD/Acc/S	LUC				
	1.6 TDI	77		09.10	PR: 1KF,1KJ								
	1.8 TSI			11.09	PR: 1KF,1KJ								
	1.9 TDI	77		10.09	PR: 1KF,1KJ								
	2.0 TDI	103		11.09	PR: 1KF,1KJ								
	2.0 TDI	125		11.09	PR: 1KF,1KJ								
	2.0 TSI	147		05.10	PR: 1KF,1KJ								
1.8 TSI 4x4			11.09	PR: 2EA	G1020682		23914 17,1 /WD/Acc/S	LUC					
2.0 TDI 4x4	125		11.09	PR: 2EA									
3.6 V6 4x4	191		11.09	PR: 2EA									
	1.4 TSI	92		11.09	PR: 1KF	G2112158		256 12,0 10,0 +C					
	1.6 TDI	77		09.10	PR: 1KF								
	1.8 TSI			11.09	PR: 1KF								
	1.9 TDI	77		10.09	PR: 1KF								
	2.0 TDI	103		11.09	PR: 1KF								
	2.0 TDI	125		11.09	PR: 1KF								
	2.0 TSI	147		05.10	PR: 1KF								
	1.4 TSI	92		11.09	PR: 1KJ					G2112169		282 12,0 10,0 +S +C	
	1.6 TDI	77		09.10	PR: 1KJ								
	1.8 TSI			11.09	PR: 1KJ								
1.9 TDI	77		10.09	PR: 1KJ									
2.0 TDI	103		11.09	PR: 1KJ	G2110356		272 9,7 8,0 +S +C						
2.0 TDI	125		11.09	PR: 1KJ									
2.0 TSI	147		05.10	PR: 1KJ									
3.6 V6 4x4	191		11.09	PR: 1KS									
1.4 TSI	92		11.09	PR: 1KS	G2110356		272 9,7 8,0 +S +C						
1.6 TDI	77		09.10	PR: 1KS									
1.8 TSI			11.09	PR: 1KS									
1.8 TSI 4x4			11.09	PR: 1KS									
1.9 TDI	77		10.09	PR: 1KS	G2110356		272 9,7 8,0 +S +C						
2.0 TDI	103		11.09	PR: 1KS									
2.0 TDI	125		11.09	PR: 1KS									
2.0 TDI 4x4	125		11.09	PR: 1KS									
2.0 TSI	147		05.10	PR: 1KS	G2110356		272 9,7 8,0 +S +C						
2.0 TSI	147		05.10	PR: 1KS									
3.6 V6 4x4	191		11.09	PR: 1KS	G2110356		272 9,7 8,0 +S +C						
3.6 V6 4x4	191		11.09	PR: 1KS									



















**SKODA YETI (09-)**

	1.2 TSI	77		09.09	PR: 1ZF	G1020463		23131 19,7 +/Wl	VW				
	1.4 TSI	90		06.10	PR: 1ZF								
	1.6 TDI	77		11.10	PR: 1ZF								
	1.8 TSI 4x4	118		05.09	PR: 1ZF								
	2.0 TDI	81		11.09	PR: 1ZF								
	2.0 TDI 4x4	81		11.09	PR: 1ZF								
	2.0 TDI 4x4	103		05.09	PR: 1ZF								
	2.0 TDI 4x4	125		11.09	PR: 1ZF								
	1.2 TSI	77		09.09	PR: 1ZA,1ZE	G1020680		23587 20,6 +/Wl	ATE				
	1.4 TSI	90		06.10	PR: 1ZA,1ZE								
	1.6 TDI	77		11.10	PR: 1ZA,1ZE								
	1.8 TSI 4x4	118		05.09	PR: 1ZA,1ZE								
	2.0 TDI	81		11.09	PR: 1ZA,1ZE								
	2.0 TDI 4x4	81		11.09	PR: 1ZA,1ZE								
	2.0 TDI 4x4	103		05.09	PR: 1ZA,1ZE								
	2.0 TDI 4x4	125		11.09	PR: 1ZA,1ZE								
	1.2 TSI	77		09.09	PR: 1ZF	G2122210		280 22,0 19,0 V L +S +C					
	1.4 TSI	90		06.10	PR: 1ZF								
	1.6 TDI	77		11.10	PR: 1ZF								
	1.8 TSI 4x4	118		05.09	PR: 1ZF								
	2.0 TDI	81		11.09	PR: 1ZF								
	2.0 TDI 4x4	81		11.09	PR: 1ZF								
	2.0 TDI 4x4	103		05.09	PR: 1ZF								
	2.0 TDI 4x4	125		11.09	PR: 1ZF								
	1.2 TSI	77		09.09	PR: 1ZE					G2125145		288 25,0 22,0 V L +S +C	
	1.4 TSI	90		06.10	PR: 1ZE								
1.6 TDI	77		11.10	PR: 1ZE									
1.8 TSI 4x4	118		05.09	PR: 1ZE									
2.0 TDI	81		11.09	PR: 1ZE									
2.0 TDI 4x4	81		11.09	PR: 1ZE									
2.0 TDI 4x4	103		05.09	PR: 1ZE	G2125158		312 25,0 22,0 V L +S +C						
2.0 TDI 4x4	125		11.09	PR: 1ZE									
1.2 TSI	77		09.09	PR: 1ZA									
1.4 TSI	90		06.10	PR: 1ZA									
1.6 TDI	77		11.10	PR: 1ZA	G2125158		312 25,0 22,0 V L +S +C						
1.8 TSI 4x4	118		05.09	PR: 1ZA									
2.0 TDI	81		11.09	PR: 1ZA									
2.0 TDI 4x4	81		11.09	PR: 1ZA									
2.0 TDI 4x4	103		05.09	PR: 1ZA	G2125158		312 25,0 22,0 V L +S +C						
2.0 TDI 4x4	125		11.09	PR: 1ZA									
1.2 TSI	77		09.09	PR: 1KD					G1020492		23554 17,1 /WD/S	LUC	
1.4 TSI	90		06.10	PR: 1KD									
1.6 TDI	77		11.10	PR: 1KD									
2.0 TDI	81		11.09	PR: 1KD									
	1.2 TSI	77		09.09	PR: 1KJ	G1020682		23914 17,1 /WD/Acc/S	LUC				
	1.4 TSI	90		06.10	PR: 1KJ								
	1.6 TDI	77		11.10	PR: 1KJ								

									
<b>SKODA YETI (09-)</b>									
	1.8 TSI 4x4 2.0 TDI 2.0 TDI 4x4 2.0 TDI 4x4 2.0 TDI 4x4	118 81 81 103 125		05.09 11.09 11.09 05.09 11.09	PR: 1KJ PR: 1KJ PR: 1KJ PR: 1KJ PR: 1KJ	G1020682		23914 17,1 /WD/Acc/S	LUC
	1.2 TSI 1.4 TSI 1.6 TDI 2.0 TDI	77 90 77 81		09.09 06.10 11.10 11.09	PR: 1KD PR: 1KD PR: 1KD PR: 1KD	G2110277		253 10,0 8,0 +S +C	
	1.2 TSI 1.4 TSI 1.6 TDI 1.8 TSI 4x4 2.0 TDI 2.0 TDI 4x4 2.0 TDI 4x4 2.0 TDI 4x4	77 90 77 118 81 81 103 125		09.09 06.10 11.10 05.09 11.09 11.09 05.09 11.09	PR: 1KJ PR: 1KJ PR: 1KJ PR: 1KJ PR: 1KJ PR: 1KJ PR: 1KJ PR: 1KJ	G2112169		282 12,0 10,0 +S +C	
	1.2 TSI 1.4 TSI 1.6 TDI 1.8 TSI 4x4 2.0 TDI 2.0 TDI 4x4 2.0 TDI 4x4 2.0 TDI 4x4	77 90 77 118 81 81 103 125		11.09 06.10 11.10 11.09 11.09 11.09 11.09 11.09	PR: 1KS PR: 1KS PR: 1KS PR: 1KS PR: 1KS PR: 1KS PR: 1KS PR: 1KS	G2110356		272 9,7 8,0 +S +C	
<b>SMART CONVERTIBLE (BM450) (00-03)</b>									
	0.6 0.6 0.6 0.7 0.7 0.8 CDI	40 45 52 45 55 30		03.00 01.01 06.02 01.03 01.03 03.01	01.04 01.04 01.04 01.04 01.04 01.04	G1020540		21999 15,8 +/Wl	BOS
	0.6 0.6 0.6 0.7 0.7 0.8 CDI	40 45 52 45 55 30		03.00 01.01 06.02 01.03 01.03 03.01	01.04 01.04 01.04 01.04 01.04 01.04	G2109136		280 9,0 8,0 L +C	
<b>SMART CITY COUPE (BM450) (98-04)</b>									
	0.6 0.6 0.6 0.6 0.7 0.7 0.7 0.8 CDI	33 40 45 52 37 45 55 30		07.98 07.98 01.01 06.02 01.03 01.03 01.03 11.99	01.04 01.04 01.04 01.04 01.04 01.04 01.04 01.04	G1020540		21999 15,8 +/Wl	BOS
	0.6 0.6 0.6 0.6 0.7 0.7 0.7 0.8 CDI	33 40 45 52 37 45 55 30		07.98 07.98 01.01 06.02 01.03 01.03 01.03 11.99	01.04 01.04 01.04 01.04 01.04 01.04 01.04 01.04	G2109136		280 9,0 8,0 L +C	
<b>SMART CROSSBLADE (BM450) (02-04)</b>									
	0.6	52		06.02	01.04	G1020540		21999 15,8 +/Wl	BOS
	0.6	52		06.02	01.04 - (D)	G2109136		280 9,0 8,0 L +C	
<b>SMART FORFOUR (BM454) (04-06)</b>									
	1.1 1.3 1.5 1.5 1.5 CDI 1.5 CDI 1.5 BRABUS	70 80 80 90 50 70 130		03.04 03.04 03.04 11.04 08.04 08.04 02.05	12.06 12.06 12.06 12.06 12.06 12.06 12.06	G1020779		21920 16,6 /Wl/Acc/S	LUC
	1.1 1.3 1.5 1.5 1.5 BRABUS 1.5 CDI 1.5 CDI	70 80 80 90 130 50 70		03.04 03.04 03.04 11.04 02.05 08.04 08.04	12.06 12.06 12.06 12.06 12.06 12.06 12.06	G1020537 G1020780		21983 17,2 /Wl/Acc/S 21861 15,2 /Wl/S	LUC LUC

									
<b>SMART FORTWO CONVERTIBLE (BM450) (04-07)</b>									
	0.7 0.7 BRABUS 0.8 CDI	45 55 30		01.04 01.04 01.04	04.07 04.07 04.07		G1020540	21999 15,8 +/Wl	BOS
	0.7 0.7 BRABUS 0.8 CDI	45 55 30		01.04 01.04 01.04	04.07 04.07 04.07		G2109136	280 9,0 8,0 L +C	
<b>SMART FORTWO COUPE (BM450) (04-07)</b>									
	0.7 0.7 0.7 BRABUS 0.8 CDI	37 45 55 30		01.04 01.04 01.04 01.04	04.07 04.07 04.07 04.07		G1020540	21999 15,8 +/Wl	BOS
	0.7 0.7 0.7 BRABUS 0.8 CDI	37 45 55 30		01.04 01.04 01.04 01.04	04.07 04.07 04.07 04.07		G2109136	280 9,0 8,0 L +C	
<b>SMART FORTWO CONVERTIBLE (BM451) (07-)</b>									
	0.8 CDI 0.8 CDi 1.0 1.0 BRABUS 1.0 BRABUS 1.0 MHD Hybrid 1.0 Turbo Electric Drive Electric Drive Electric Drive Electric Drive Electric Drive BRABUS	33 40 52 88 88 71 62 20 30 35 55 60		04.07 08.09 04.07 07.07 04.12 10.07 04.07 12.10 11.09 12.11 04.12 01.13			G1020540	21999 15,8 +/Wl	BOS
<b>SMART FORTWO COUPE (BM451) (07-)</b>									
	0.8 CDI 0.8 CDi 1.0 1.0 1.0 1.0 BRABUS 1.0 MHD Hybrid 1.0 Turbo Electric Drive Electric Drive Electric Drive Electric Drive Electric Drive BRABUS	33 40 45 52 88 72 71 62 20 30 35 55 60		04.07 08.09 04.07 04.07 01.10 07.07 10.07 04.07 12.10 11.09 12.11 04.12 01.13			G1020540	21999 15,8 +/Wl	BOS
<b>SMART ROADSTER (BM452) (03-05)</b>									
	0.7 0.7 0.7 BRABUS	45 60 74		04.03 04.03 03.04	12.05 12.05 12.05		G1020540	21999 15,8 +/Wl	BOS
	0.7 0.7 0.7 BRABUS	45 60 74		04.03 04.03 03.04	12.05 12.05 12.05		G2109136	280 9,0 8,0 L +C	
<b>SMART ROADSTER COUPE (BM452) (03-05)</b>									
	0.7 0.7 0.7 BRABUS	45 60 74		04.05 04.03 03.04	12.05 12.05 12.05		G1020540	21999 15,8 +/Wl	BOS
	0.7 0.7 0.7 BRABUS	45 60 74		04.05 04.03 03.04	12.05 12.05 12.05		G2109136	280 9,0 8,0 L +C	
<b>SUBARU FORESTER (02-08)</b>									
	2.0 2.0 S Turbo 2.0 X 2.5 Allrad 2.5 AWD 2.5 RX AWD 2.5 Turbo 2.5 XT	92 130 116 121 112 115 155 169		09.02 09.02 09.05 07.05 06.02 11.02 12.03 09.05	05.08 05.08 05.08 05.08 05.05 08.05 05.08 05.08		G1205418	23865 17,6 +/Wl/Acc	TOK
<b>SUBARU FORESTER (08-)</b>									
	2.0 i 16V 2.0 TD 2.5 i 16V	110 108 126		01.08 09.08 01.09	03.10 03.10		G1205418	23865 17,6 +/Wl/Acc	TOK
<b>SUBARU IMPREZA Saloon (00-05)</b>									
	2.0 GX (GD)	92		11.02	09.05		G1205418	23865 17,6 +/Wl/Acc	TOK

							
<b>SUBARU IMPREZA Estate (00-05)</b>							
	2.0 GX (GG)	92		11.02	09.05	G1205418	23865 17,6 +/W/Acc TOK
<b>SUBARU IMPREZA (08-)</b>							
	1.5 16V	79		02.08		G1205418	23865 17,6 +/W/Acc TOK
	1.5 16V Allrad	79		02.08			
	2.0 16V	110		02.08			
	2.0 16V Allrad	110		02.08			
	2.0 D Allrad	110		01.09			
<b>SUBARU JUSTY (G3X) (03-07)</b>							
	1.3 i 16V	66		09.03	08.07	G1020605	23605 15,7 +/W/Acc/S BOS
	1.3 i 16V 4WD	69		09.03	08.07		
	1.5 i 16V 4WD	73		09.03	08.07		
<b>SUBARU JUSTY (07-11)</b>							
	1.0 i 12V (AL276)	51		09.07	05.11 + 14" wheel/+ manual transm.	G1201053	24283 15,5 +/W/Acc/S
	1.3 AWD	67		03.08	05.11 + 14" wheel/+ manual transm.		
<b>SUBARU LEGACY (03-09)</b>							
	2.0 i 16V	101		09.03	10.05	G1205418	23865 17,6 +/W/Acc TOK
	2.0 TD	110		02.08	04.09		
	2.0 Turbo R AWD	121		06.05	04.09		
	2.5 i 16V	127		09.07	04.09		
<b>SUBARU LECACY (09-)</b>							
	2.0 16V 4x4	118		09.09		G1205418	23865 17,6 +/W/Acc TOK
	2.0 TD 4x4	110		09.09			
<b>SUBARU OUTBACK (03-09)</b>							
	2.0 16V 4x4	101		09.03	01.05	G1205418	23865 17,6 +/W/Acc TOK
	2.0 TD 4x4	110		09.08	04.09		
	2.5 16V 4x4	121		11.03	04.09		
	2.5 16V 4x4	127		09.08	06.09		
<b>SUBARU OUTBACK (09-)</b>							
	2.0 TD 4x4	110		09.09		G1205418	23865 17,6 +/W/Acc TOK
<b>SUBARU TREZIA (11-)</b>							
	1.3 16V	73		03.11		G1201065	24336 17,5 AKE
	1.4 D	66		03.11			
	1.3 16V	73		03.11		G1020975	24610 15,0 +/W
	1.4 D	66		03.11			
<b>SUZUKI GRAND VITARA (05-)</b>							
	1.6 16V	78		04.05		G1201085	24346 16,4 /W/Acc
	1.6 i 16V 4x4	73		09.05			
	1.6 i 16V 4x4	78		04.05			
	1.9 DDiS	95		10.05	08.08		
	1.9 DDiS 4x4	95		10.05			
	2.0 VVTi 4x4	103		10.05			
	2.7 VVTi 4x4	135		01.07			
	2.7 VVTi 4x4	136		10.05	08.08		
<b>SUZUKI IGNIS II (03-12)</b>							
	1.3 DDiS	51		09.03	12.12	G1020605	23605 15,7 +/W/Acc/S BOS
	1.3 i 16V	69		09.03	12.12		
	1.3 i 16V 4x4	69		09.03	12.12		
	1.5 i 16V	73		09.03	12.12		
	1.5 i 16V 4x4	73		09.03	12.12		
<b>SUZUKI SPLASH (08-)</b>							
	1.0 i 12V	48		01.08		G1201059	24403 17,2 +/W LUC
	1.0 i 12V	50		06.11			
	1.2 16V	63		01.08			
	1.2 VVT	66		06.11			
	1.2 VVT	67		08.12			
	1.2 VVT	69		09.10			
	1.3 CDTi	55		01.08			
	1.0 i 12V	48		01.08		G2120211	252 20,0 18,0 V +S +C
	1.0 i 12V	50		06.11			
	1.2 16V	63		01.08			
	1.2 VVT	66		06.11			
	1.2 VVT	67		08.12			
	1.2 VVT	69		09.10			
	1.3 CDTi	55		01.08			



























							
<b>SUZUKI SWIFT II (96-04)</b>							
	1.0 i (SF310) 1.3 i (SF413) 1.3 i (SF413)	39 50 63	11.96 11.96 06.01	12.04 12.04 12.04	- ABS	G1201056	21730 14,0 +/W/Acc
<b>SUZUKI SWIFT III (05-10)</b>							
	1.3 16V 1.3 16V 4x4 1.3 16V 4x4 1.3 DDiS 1.3 DDiS 1.5 16V 4x4 1.5 VVTi 1.6 VVTi	68 66 68 51 55 74 75 92	02.05 01.06 02.05 08.05 08.05 02.05 02.05 05.06	09.10 09.10 09.10 09.07 09.10 09.10 09.10 09.10		G1201059	24403 17,2 +/W/LUC
	1.3 16V 1.3 16V 4x4 1.3 16V 4x4 1.3 DDiS 1.3 DDiS 1.5 16V 4x4 1.5 VVTi	68 66 68 51 55 74 75	02.05 01.06 02.05 08.05 08.05 02.05 02.05	09.10 09.10 09.10 09.07 09.10 09.10 09.10		G2120211	252 20,0 18,0 V +S +C
<b>SUZUKI SX4 (06-)</b>							
	1.5 i 16V 1.5 VVT 1.6 DDiS 1.6 i 16V 1.6 i 16V 4x4 1.6 VVT 1.6 VVT 4x4 1.9 DDiS 1.9 DDiS 4x4 2.0 DDiS 2.0 DDiS 4x4	73 82 66 88 88 79 79 88 88 99 99	06.06 07.10 04.07 10.07 07.09 06.06 06.06 06.06 06.06 07.09 07.09	country of manufacture (H) <sup>1)</sup> country of manufacture (H) <sup>1)</sup>  country of manufacture (H) <sup>1)</sup> country of manufacture (H) <sup>1)</sup> country of manufacture (H) <sup>1)</sup> country of manufacture (H) <sup>1)</sup>		G1020774	24391 16,6 +/W/Acc/S LUC
<b>SUZUKI WAGON R+ (00-08)</b>							
	1.0 i 12V 1.2 i 16V 1.3 DDiS 1.3 i 16V 1.3 i 16V 1.3 i 16V 1.3 i 16V 4WD 1.3 i 16V 4WD	44 59 51 56 65 69 56 69	06.04 06.04 09.03 05.00 08.01 09.03 10.01 09.03	04.08 04.08 04.08 08.03 04.08 04.08 08.03 04.08		G1020605	23605 15,7 +/W/Acc/S BOS
<b>TOYOTA AURIS (06-12)</b>							
	1.33 Dual-VVTi 1.4 D-4D 1.4 VVTi 1.6 16V 1.6 VVTi 1.8 16V 1.8 VVTi 1.8 Hybrid	74 66 71 97 91 108 100 73	05.09 03.07 03.07 05.09 03.07 02.09 10.06 09.10	09.12 09.12 country of manufacture (GB) <sup>2)</sup> country of manufacture (GB) <sup>2)</sup> country of manufacture (GB) <sup>2)</sup> 09.12 09.12		G1020988	24122 19,0 +/W/Acc
	1.4 VVTi 1.6 16V 1.6 VVTi	71 97 91	03.07 05.09 03.07	09.12 country of manufacture (J) <sup>3)</sup> country of manufacture (J) <sup>3)</sup> country of manufacture (J) <sup>3)</sup>		G1201065	24336 17,5 AKE
	1.4 VVTi 1.6 16V 1.6 VVTi 1.8 Hybrid	71 97 91 73	03.07 05.09 03.07 09.10	09.12 country of manufacture (J) <sup>3)</sup> country of manufacture (J) <sup>3)</sup> country of manufacture (J) <sup>3)</sup> 09.12		G1020975	24610 15,0 +/W/L
	1.33 Dual-VVTi 1.4 D-4D 1.4 VVTi 1.6 16V 1.6 VVTi 1.8 16V 1.8 VVTi 2.0 D-4D 2.2 D-4D	74 66 71 97 91 108 100 93 130	05.09 03.07 03.07 05.09 03.07 02.09 10.06 03.07 03.07	09.12 country of manufacture (GB) <sup>2)</sup> country of manufacture (GB) <sup>2)</sup> country of manufacture (GB) <sup>2)</sup> country of manufacture (GB) <sup>2)</sup> 09.12 09.12		G1020768	24664 15,2 +/W/Acc
<b>TOYOTA AURIS (12-)</b>							
	1.8 Hybrid	73	10.12	+ panoramic sunroof <sup>4)</sup>		G1020994	24337 17,5
	1.3 VVTi 1.4 D-4D 1.6 VVTi	73 66 97	10.12 10.12 10.12	Modelcode ZRE 181		G1020768	24664 15,2 +/W/Acc
<b>TOYOTA AVENSIS (03-09)</b>							
	1.6 i 16V 1.8 i 16V 2.0 D-4D 2.0 D-4D 2.0 i 16V 2.2 D-4D 2.2 D-CAT	81 95 85 93 108 110 130	04.03 04.03 04.03 03.06 04.03 10.05 07.05	12.07 12.07 04.06 12.07 12.07 12.07 12.07		G1020662	23768 19,3 +/W/L BOS

<sup>1)</sup> paese del costruttore (H) / pays du constructeur (H) / país del fabricante (H) / Herst.Land (H)

<sup>2)</sup> paese del costruttore (GB) / pays du constructeur (GB) / país del fabricante (GB) / Herst.Land (GB)

<sup>3)</sup> paese del costruttore (J) / pays du constructeur (J) / país del fabricante (J) / Herst.Land (J)

<sup>4)</sup> + tetto panoramico / + toit panoramique / + techo panorámico / + Panorama-Sonnendach

























								
<b>TOYOTA AVENSIS (03-09)</b>								
	2.4 i 16V 2.4 i 16V	120 125		10.03 09.03	12.07 12.07		G1020662	23768 19,3 +/Wl BOS
	1.6 i 16V 1.8 i 16V 2.0 D-4D 2.0 D-4D 2.0 i 16V 2.2 D-4D 2.2 D-CAT 2.4 i 16V 2.4 i 16V	81 95 85 93 108 110 130 120 125		04.03 04.03 04.03 03.06 04.03 10.05 07.05 10.03 09.03	01.09 01.09 04.06 01.09 01.09 01.09 01.09 01.09 01.09		G1020663	23620 16,4 +/Wl BOS
<b>TOYOTA AYGO (05-)</b>								
	1.0 i 12V 1.0 i 12V GPL 1.4 HDi	50 50 40		07.05 07.05 07.05			G1020830	23959 17,0 /Acc/S BOS
	1.0 i 12V 1.0 i 12V GPL 1.4 HDi	50 50 40		07.05 07.05 07.05	08.10		G2120180	247 20,0 18,0 V +S +C
<b>TOYOTA CAMRY (01-05)</b>								
	2.0 VVTi (ACV31) 2.4 VVTi (ACV30) 3.0 i V6 (MCV30)	110 112 137		12.01 12.01 12.01	12.05 12.05 12.05		G1205242	23928 17,3
<b>TOYOTA CAMRY (06-)</b>								
	2.4 VVTi (ACV40) 2.4 VVTi (ACV40) 2.4 VVTi Hybrid 3.5 VVTi (GSV40)	116 123 105 197		01.06 01.06 01.06 01.06			G1201022	24338 15,5 AKE
<b>TOYOTA CARINA E (92-97)</b>								
	1.6 i (AT190) 2.0 D (CT190)			02.92 02.92	09.97 09.97		G2125124	255 24,9 24,0 V +C
<b>TOYOTA CELICA (93-99)</b>								
	1.8 i (AT200)			11.93	11.99		G2125124	255 24,9 24,0 V +C
<b>TOYOTA CELICA (99-05)</b>								
	1.8 VVTi (ZZT230)	105		11.99	07.02		G1020714	23510 16,5 +/Wl AKE
	1.8 VVTi (ZZT230)	105		11.99	07.02		G2125124	255 24,9 24,0 V +C
<b>TOYOTA COROLLA (02-04)</b>								
	1.4 VVTi (ZZE120) 1.6 VVTi (ZZE121)	71 81		01.02 01.02	05.04 05.04		G1020714	country of manufacture <sup>1)</sup> 23510 16,5 +/Wl AKE
	1.4 VVTi (ZZE120) 1.6 VVTi (ZZE121) 1.8 VVTi TS (ZZE123) 2.0 D-4D (CDE120) 2.0 D-4D (CDE120) 2.0 D-4D (CDE120)	71 81 141 66 81 85		02.02 08.02 01.02 08.02 01.02 05.03	05.04 05.04 05.04 05.04 05.04 05.04		G1020712	country of manufacture <sup>2)</sup> 23766 17,8 +/Wl LUC
	1.4 VVTi (ZZE120) 1.6 VVTi (ZZE121)	71 81		01.02 01.02	05.04 05.04		G2125155	255 25,0 23,0 V +C
	1.4 VVTi (ZZE120) 1.6 VVTi (ZZE121) 1.8 VVTi TS (ZZE123) 2.0 D-4D (CDE120) 2.0 D-4D (CDE120) 2.0 D-4D (CDE120)	71 81 141 66 81 85		02.02 08.02 01.02 08.02 01.02 05.03	05.04 05.04 05.04 05.04 05.04 05.04		G1020713	country of manufacture <sup>2)</sup> 23816 16,0 /Wl LUC
	1.4 VVTi (ZZE120) 1.6 VVTi (ZZE121) 2.0 D-4D (CDE120)	71 81 66		01.02 01.02 01.02	05.04 05.04 05.04		G2109139	country of manufacture <sup>1)</sup> 269 9,0 8,0 +C
<b>TOYOTA COROLLA (04-06)</b>								
	1.4 D-4D (NDE120) 1.4 VVTi (ZZE120) 1.6 VVTi (ZZE121) 1.8 VVTi (ZZE123) 2.0 D-4D (CDE120)	66 71 81 141 85		06.04 06.04 06.04 06.04 06.04	10.06 10.06 10.06 10.06 10.06		G1020712	23766 17,8 +/Wl LUC
	1.4 VVTi (ZZE120) 1.6 VVTi (ZZE121) 1.8 VVTi (ZZE123)	71 81 141		06.04 06.04 06.04	10.06 10.06 10.06		G2125155	255 25,0 23,0 V +C

1) paese del costruttore <sup>1)</sup> / pays du constructeur <sup>1)</sup> / pais del fabricante <sup>1)</sup> / Herst.Land <sup>1)</sup>

2) paese del costruttore <sup>2)</sup> / pays du constructeur <sup>2)</sup> / pais del fabricante <sup>2)</sup> / Herst.Land <sup>2)</sup>



									
<b>TOYOTA COROLLA (04-06)</b>									
	1.4 D-4D (NDE120)	66		06.04	10.06		G1020713	23816 16,0 /WI	LUC
	1.4 VVTi (ZZE120)	71		06.04	10.06				
	1.6 VVTi (ZZE121)	81		06.04	10.06				
	1.8 VVTi (ZZE123)	141		06.04	10.06				
	2.0 D-4D (CDE120)	85		06.04	10.06				
<b>TOYOTA COROLLA (06-)</b>									
	1.4 D-4D (NDE150)	66		01.09			G1020988	24122 19,0 +/WI/Acc	
	1.33 16V (NRE150)	74		10.08			G1201065	24336 17,5	AKE
	1.4 VVTi (ZZE150)	71		11.06	12.08				
	1.6 VVTi (ZRE151)	91		11.06	12.08				
	1.6 VVTi (ZRE151)	97		01.09					
	1.33 16V (NRE150)	74		10.08			G1020975	24610 15,0 +/WI	
	1.4 VVTi (ZZE150)	71		11.06	12.08				
	1.6 VVTi (ZRE151)	91		11.06	12.08				
	1.6 VVTi (ZRE151)	97		01.09					
	1.4 D-4D (NDE150)	66		01.09			G1020768	24664 15,2 +/WI/Acc	
	2.0 D-4D (ADE150)	93		01.07					
<b>TOYOTA COROLLA VERSO (02-04)</b>									
	1.4 VVTi (ZZE120)	71		01.02	05.04		G1020714	23510 16,5 +/WI	AKE
	1.6 VVTi (ZZE121)	81		01.02	05.04				
	1.4 VVTi (ZZE120)	71		01.02	05.04		G2125155	255 25,0 23,0 V +C	
	1.6 VVTi (ZZE121)	81		01.02	05.04				
	1.4 VVTi (ZZE120)	71		01.02	05.04		G2109139	269 9,0 8,0 +C	
	1.6 VVTi (ZZE121)	81		01.02	05.04				
	1.8 VVTi (ZZE122)	99		01.02	05.04				
	2.0 D-4D (CDE120)	66		01.02	05.04				
<b>TOYOTA COROLLA VERSO (04-09)</b>									
	1.6 VVTi (ZNR10)	81		05.04	03.09		G1020662	23768 19,3 +/WI	BOS
	1.8 VVTi (ZNR11)	95		05.04	03.09				
	2.0 D-4D (CUR10)	85		05.04	03.09				
	2.2 D-4D (AUR10)	100		09.05	03.09				
	2.2 D-4D (AUR10)	130		09.05	03.09				
	1.6 VVTi (ZNR10)	81		05.04	03.09		G1020663	23620 16,4 +/WI	BOS
	1.8 VVTi (ZNR11)	95		05.04	03.09				
	2.0 D-4D (CUR10)	85		05.04	03.09				
	2.2 D-4D (AUR10)	100		09.05	03.09				
	2.2 D-4D (AUR10)	130		09.05	03.09				
<b>TOYOTA FJ CRUISER (11-)</b>									
	4.0 VVTi (GSJ10)	178		01.11			G1205333	24024 17,0 +/WI	
	4.0 VVTi 4WD (GSJ15)	178		01.11					
	4.0 VVTi (GSJ10)	178		01.11			G1205404	21947 15,4	
	4.0 VVTi 4WD (GSJ15)	178		01.11					
<b>TOYOTA IQ (09-)</b>									
	1.0 i 12V	50		01.09			G1020714	23510 16,5 +/WI	AKE
	1.33	69		01.09					
	1.33	72		01.09					
	1.4 D-4D	66		01.09					
	1.0 i 12V	50		01.09		+ ABS	G1020975	24610 15,0 +/WI	
	1.33	69		01.09		+ ABS			
	1.33	72		01.09		+ ABS			
	1.4 D-4D	66		01.09		+ ABS			
<b>TOYOTA LAND CRUISER 70-75 (90-96)</b>									
	2.4 (RJ70/73)			01.90	12.96		G1205404	21947 15,4	
	2.4 TD (LJ70/73)			01.90	05.96				
	4.2 TD (HZJ70/73)			01.90	12.96				
<b>TOYOTA LAND CRUISER ESTATE 80 ( 90-97)</b>									
	4.0 i (FJ80)			01.90	08.92		G1205404	21947 15,4	
	4.2 D (HZJ80)			01.90	12.97				
	4.2 TD (HDJ80)			01.90	12.97				
	4.5 i 24V (FZJ80)			08.92	12.97				
<b>TOYOTA LAND CRUISER 90-95 (96-02)</b>									
	3.0 D-4D (KDJ90/95)	120		08.00	08.02		G1205404	21947 15,4	
	3.0 TD (KZJ90/95)	92		04.96	07.00				
	3.4 i 24V (VZJ90/95)	131		04.96	08.02				
<b>TOYOTA LAND CRUISER 120 (03-)</b>									
	3.0 D-4D	120		01.03			G1205333	24024 17,0 +/WI	
	3.0 D-4D	122		01.05	10.06				
	3.0 D-4D	127		11.06					
	4.0 VVTi	183		01.03					

								
<b>TOYOTA LAND CRUISER 120 (03-)</b>								
	3.0 D-4D	120	01.03				G1205404	21947 15,4
	3.0 D-4D	122	01.05	10.06				
	3.0 D-4D	127	11.06					
	4.0 VVTi	183	01.03					
<b>TOYOTA LAND CRUISER 150 (10-)</b>								
	2.7 4WD	120	01.10				G1205333	24024 17,0 +/WI
	3.0 D-4D	127	03.10					
	3.0 D-4D	140	01.10					
	4.0 V6 Dual VVTi	205	01.10					
	4.0 V6 VVTi	207	01.10					
	2.7 4WD	120	01.10				G1205404	21947 15,4
	3.0 D-4D	127	03.10					
	3.0 D-4D	140	01.10					
	4.0 V6 Dual VVTi	205	01.10					
	4.0 V6 VVTi	207	01.10					
<b>TOYOTA MR2 (00-05)</b>								
	1.8 VVTi (ZZW30)	103	04.00	09.05			G1020714	23510 16,5 +/WI AKE
	1.8 VVTi (ZZW30)	103	04.00	09.05			G2120175	255 20,0 18,0 V +C
<b>TOYOTA PREVIA (05-)</b>								
	2.4 i 16V (ACR50)	125	10.05				G1020663	23620 16,4 +/WI BOS
	2.4 i 16V 4x4 (ACR50)	125	10.05					
	3.5 i V6 (GSR50)	206	11.06					
	3.5 i V6 4x4 (GSR50)	206	11.06					
<b>TOYOTA PRIUS (00-03)</b>								
	1.5 i 16V (NHW11)	53	05.00	07.03			G1020714	23510 16,5 +/WI AKE
	1.5 i 16V (NHW11)	53	05.00	07.03			G2125155	255 25,0 23,0 V +C
	1.5 i 16V (NHW11)	53	05.00	07.03			G2109139	269 9,0 8,0 +C
<b>TOYOTA PRIUS (03-09)</b>								
	1.5 VVTi (NHW20)	57	08.03	03.09			G1020714	23510 16,5 +/WI AKE
	1.5 VVTi (NHW20)	57	08.03	03.09			G2122258	255 22,0 20,0 V +C
<b>TOYOTA PRIUS (09-12)</b>								
	1.8 Hybrid (ZVW30)	73	01.09	03.12			G1020975	24610 15,0 +/WI
<b>TOYOTA PRIUS PLUS (12-)</b>								
	1.8 Hybrid (ZVW40)	73	03.12				G1020994	24337 17,5
<b>TOYOTA RAV4 III (05-)</b>								
	2.0 16V	116	12.08				G1020994	24337 17,5
	2.0 16V 4WD	116	12.08					
	2.0 VVT-i	109	03.09					
	2.0 VVT-i	112	03.09					
	2.0 VVT-i 4WD	109	03.09					
	2.0 VVT-i 4WD	112	03.06					
	2.2 D-4D	110	12.08					
	2.2 D-4D 4WD	100	03.06					
	2.2 D-4D 4WD	110	12.08					
	2.2 D-CAT 4WD	130	03.06					
	2.4 VVT-i	125	11.05					
	2.4 VVT-i 4WD	125	11.05					
	3.5 VVT-i 4WD	201	11.05				G1201065	24336 17,5 AKE
	3.5 VVT-i 4WD	206	08.07					
	2.0 16V	116	12.08				G1201022	24338 15,5 AKE
	2.0 16V 4WD	116	12.08					
	2.0 VVT-i	109	03.09					
	2.0 VVT-i	112	03.09					
	2.0 VVT-i 4WD	109	03.09					
	2.0 VVT-i 4WD	112	03.06					
	2.2 D-4D	110	12.08					
	2.2 D-4D 4WD	100	03.06					
	2.2 D-4D 4WD	110	12.08					
	2.2 D-CAT 4WD	130	03.06					
↓	↓							

### TOYOTA RAV4 III (05-)

	2.4 VVT-i 2.4 VVT-i 4WD 3.5 VVT-i 4WD 3.5 VVT-i 4WD	125 125 201 206	11.05 11.05 11.05 08.07		G1201022		24338 15,5	AKE
--	--	--------------------------	----------------------------------	--	----------	--	------------	-----

### TOYOTA RAV4 IV (12-)

	2.0 VVT-i 2.0 VVT-i 4WD 2.5 VVT-i 4WD	107 111 132	12.12 12.12 12.12		G1020994		24337 17,5	
	2.0 D4-D 2.0 VVT-i 2.0 VVT-i 4WD 2.2 D4-D 4WD 2.5 VVT-i 4WD	91 107 111 110 132	12.12 12.12 12.12 12.12 12.12		G1201022		24338 15,5	AKE

### TOYOTA URBAN CRUISER (09-)

	1.33 16V 1.33 16V 1.4 D-4D 1.4 D-4D 4x4	73 74 66 66	04.10 04.09 04.09 04.09		G1201065		24336 17,5	AKE
	1.33 16V 1.33 16V 1.4 D-4D 1.4 D-4D 4x4	73 74 66 66	04.10 04.09 04.09 04.09	11.11	G1020975		24610 15,0 +/WI	



### TOYOTA VERSO (09-)

	1.6 16V 1.6 16V 1.8 16V 1.8 16V 2.0 D-4D 2.2 D-4D 2.2 D-4D 2.2 D-CAT	81 97 95 108 93 100 110 130	02.09 02.09 02.09 02.09 02.09 02.09 02.09 02.09		G1201209		24926 16,5 +/WI/Acc	BOS
--	---	--	--	--	----------	--	---------------------	-----

### TOYOTA VERSO S (10-)

	1.33 1.33 1.4 D4-D	70 73 66	11.10 11.10 11.10		G1201065		24336 17,5	AKE
	1.33 1.33 1.4 D4-D	70 73 66	11.10 11.10 11.10		G1020975		24610 15,0 +/WI	

### TOYOTA YARIS (99-05)

	1.0 i 16V 1.0 i 16V 1.3 i 16V 1.4 D-4D	48 50 64 55	04.03 08.99 04.02 04.03	08.05 + RA drum brake 1) 03.03 + RA drum brake 1) 08.05 + RA drum brake 1) 08.05 + RA drum brake 1)	G1020478		23340 17,0 +/WI	BOS
	1.0 i 16V 1.0 i 16V 1.3 i 16V 1.3 i 16V 1.4 D-4D 1.5 VVTi Sport 1.5 VVTi Sport 1.5 VVTi Turbo Sport	48 50 63 64 55 77 78 110	04.03 08.99 09.99 04.02 12.01 01.03 04.01 04.03	08.05 + RA disc brake 2) 03.03 + RA disc brake 2) 10.04 + RA disc brake 2) 03.03 + RA disc brake 2) 08.05 + RA disc brake 2) 08.05 + RA disc brake 2) 03.03 + RA disc brake 2) 10.04 + RA disc brake 2)	G1020714		23510 16,5 +/WI	AKE
	1.0 i 16V 1.0 i 16V 1.3 i 16V 1.3 i 16V 1.4 D-4D	48 50 63 64 55	04.03 03.99 09.99 04.02 12.01	08.05 + RA drum brake 1) 07.99 + RA drum brake 1) 10.04 + RA drum brake 1) 08.05 + RA drum brake 1) 08.05 + RA drum brake 1)	G2118131		235 17,9 16,0 V + C	
	1.0 i 16V 1.0 i 16V 1.3 i 16V 1.3 i 16V 1.4 D-4D 1.5 VVTi Sport 1.5 VVTi Sport 1.5 VVTi Turbo Sport	48 50 63 64 55 77 78 110	04.03 08.99 09.99 04.02 12.01 01.03 04.01 04.03	08.05 + RA disc brake 2) 03.03 + RA disc brake 2) 10.04 + RA disc brake 2) 08.05 + RA disc brake 2) 08.05 + RA disc brake 2) 08.05 + RA disc brake 2) 03.03 + RA disc brake 2) 10.04 + RA disc brake 2)	G2120175		255 20,0 18,0 V + C	
	1.0 i 16V 1.0 i 16V 1.3 i 16V 1.3 i 16V 1.4 D-4D 1.5 VVTi Sport 1.5 VVTi Sport 1.5 VVTi Turbo Sport	48 50 63 64 55 77 78 110	04.03 03.99 09.99 04.02 12.01 01.03 04.01 04.03	08.05 + ABS 03.03 + ABS 10.04 + ABS 08.05 + ABS 08.05 + ABS 08.05 03.03 10.04	G2109139		269 9,0 8,0 + C	

### TOYOTA YARIS (06-11)

	1.0 GPL 1.0 VVT-i 1.8 VVT-i	51 51 98	01.06 01.06 01.07	08.11 + ABS 08.11 + ABS 08.11	G1020974	country of manufacture (D) 3)	24347 17,5	AKE
	1.0 GPL 1.0 VVT-i 1.3 VVT-i 1.3 VVT-i	51 51 63 64	01.06 01.06 01.06 01.06	08.11 08.11 08.11 08.11	G1020798	country of manufacture (F) 4)	24022 17,8 +/WI	ATE

1) + P freno a tamburo / + frein à tambour essieu AR / + ET-tambores de freno / + HA-Trommelbremse  
 2) + P disco freno / + frein à disque essieu AR / + ET-disco de freno / + HA-Scheibenbremse  
 3) paese del costruttore (D) / pays du constructeur (D) / pais del fabricante (D) / Herst.Land (D)  
 4) paese del costruttore (F) / pays du constructeur (F) / pais del fabricante (F) / Herst.Land (F)



TOYOTA YARIS (06-11)										
	1.33 VVT-i 1.4 D-4D	74 66		03.09 01.06	08.11 08.11		G1020798	country of manufacture (P) 1)	24022 17,8 +/Wl	ATE
	1.0 GPL 1.0 VVT-i 1.3 VVT-i 1.3 VVT-i 1.33 VVT-i 1.4 D-4D	51 51 63 64 74 66		01.06 01.06 01.06 01.06 03.09 01.06	08.11 08.11 08.11 08.11 08.11 08.11		G2122240	country of manufacture (P) 1)	258 22,0 20,0 V +C	
	1.0 GPL 1.0 VVT-i 1.8 VVT-i	51 51 98		01.06 01.06 01.07	08.11 08.11 08.11	+ ABS + ABS	G1020975	country of manufacture (J) 2)	24610 15,0 +/Wl	
	1.0 GPL 1.0 VVT-i 1.3 VVT-i 1.3 VVT-i 1.33 VVT-i 1.4 D-4D	51 51 63 64 74 66		01.06 01.06 01.06 01.06 03.09 01.06	08.11 08.11 08.11 08.11 08.11 08.11	+ ABS + ABS + ABS + ABS + ABS + ABS	G1020666	country of manufacture (P) 1)	24574 15,0 +/Wl	ATE
	1.0 GPL 1.0 VVT-i 1.3 VVT-i 1.3 VVT-i 1.33 VVT-i 1.4 D-4D	51 51 63 64 74 66		01.06 01.06 01.06 01.06 03.09 01.06	08.11 08.11 08.11 08.11 08.11 08.11	+ ABS + ABS + ABS + ABS + ABS + ABS	G2109142	country of manufacture (P) 1)	278 9,0 7,0 +C	

TOYOTA YARIS (11-)										
	1.0 VVTi 1.3 VVTi 1.3 VVTi 1.3 VVTi 1.3 VVTi 4WD 1.4 D-4D	51 63 70 73 70 66		09.11 01.11 09.11 09.11 09.11 09.11		country of manufacture (P) 1) country of manufacture (P) 1) country of manufacture (P) 1) country of manufacture (P) 1) country of manufacture (P) 1)	G1020798		24022 17,8 +/Wl	ATE
	1.3 VVTi 1.3 VVTi 1.3 VVTi 1.3 VVTi 4WD	63 70 73 70		01.11 09.11 09.11 09.11		country of manufacture (J) 2) country of manufacture (J) 2) country of manufacture (J) 2) country of manufacture (J) 2)	G1020974		24347 17,5	AKE
	1.0 VVTi 1.3 VVTi 1.3 VVTi 1.3 VVTi 1.3 VVTi 4WD 1.4 D-4D	51 63 70 73 70 66		09.11 01.11 09.11 09.11 09.11 09.11		country of manufacture (P) 1) country of manufacture (P) 1) country of manufacture (P) 1) country of manufacture (P) 1) country of manufacture (P) 1)	G2122240		258 22,0 20,0 V +C	
	1.0 VVTi 1.3 VVTi 1.3 VVTi 1.3 VVTi 1.3 VVTi 4WD 1.4 D-4D 1.5 Hybrid	51 63 70 73 70 66 55		09.11 01.11 09.11 09.11 09.11 09.11 03.12		country of manufacture (P) 1) country of manufacture (P) 1) country of manufacture (P) 1) country of manufacture (P) 1) country of manufacture (P) 1)	G1020666	+ ESP	24574 15,0 +/Wl	ATE
	1.0 VVTi 1.3 VVTi 1.3 VVTi 1.3 VVTi 1.3 VVTi 4WD 1.4 D-4D 1.5 Hybrid	51 63 70 73 70 66 55		09.11 01.11 09.11 09.11 09.11 09.11 03.12		country of manufacture (P) 1) country of manufacture (P) 1) country of manufacture (P) 1) country of manufacture (P) 1) country of manufacture (P) 1)	G2109142	+ ESP	278 9,0 7,0 +C	

TOYOTA YARIS VERSO (99-05)										
	1.3 i 16V 1.3 i 16V 1.4 D-4D 1.5 VVTi 1.5 VVTi Sport	62 63 55 77 78		01.03 11.99 12.01 05.03 03.00	09.05 03.03 09.05 09.05 03.03		G1020478 G1020714		23340 17,0 +/Wl 23510 16,5 +/Wl	BOS AKE
	1.3 i 16V 1.3 i 16V 1.4 D-4D 1.5 VVTi 1.5 VVTi Sport	62 63 55 77 78		01.03 11.99 12.01 05.03 03.00	09.05 03.03 09.05 09.05 03.03		G2120175		255 20,0 18,0 V +C	
	1.3 i 16V 1.3 i 16V 1.4 D-4D 1.5 VVTi 1.5 VVTi Sport	62 63 55 77 78		01.03 11.99 12.01 05.03 03.00	09.05 03.03 09.05 09.05 03.03	+ ABS + ABS + ABS + ABS + ABS	G2109139		269 9,0 8,0 +C	

VOLKSWAGEN BORA (98-04)										
	1.4 16V 1.6 1.8 1.8 4motion 1.9 SDI 1.9 TDI 1.9 TDI 1.9 TDI 1.9 TDI 4motion 1.9 TDI 4motion 2.0	92 92 66 81 85 66 85 85		1J-X-800000 1J-X-800000 1J-X-800000 1J-X-800000 1J-X-800000 1J-X-800000 1J-X-800000 1J-X-800000 1J-X-800000 1J-X-800000 1J-X-800000	09.98 09.98 09.98 02.99 09.98 09.98 02.99 09.98 02.99 02.99 09.98	PR: 1LR,1LS,1LQ,1ZM PR: 1LR,1LS,1LQ,1ZM PR: 1LR,1LS,1LQ,1ZM PR: 1LR,1LS,1LQ,1ZM PR: 1LR,1LS,1LQ,1ZM PR: 1LR,1LS,1LQ,1ZM PR: 1LR,1LS,1LQ,1ZM PR: 1LR,1LS,1LQ,1ZM PR: 1LR,1LS,1LQ,1ZM PR: 1LR,1LS,1LQ,1ZM PR: 1LR,1LS,1LQ,1ZM	G1020331		23130 19,7 +	VW

1) paese del costruttore (P) / pays du constructeur (P) / pais del fabricante (P) / Herst.Land (P)  
 2) paese del costruttore (J) / pays du constructeur (J) / pais del fabricante (J) / Herst.Land (J)







**VOLKSWAGEN BORA (98-04)**

	1.9 TDI	74		09.00	12.04	PR: 1LQ	<b>G2122151</b>		256 22,0 19,0 V L +S +C
	1.9 TDI	81		09.98	06.01	PR: 1LQ			
	1.9 TDI	85		02.99	06.01	PR: 1LQ			
	1.9 TDI	96		04.01	12.04	PR: 1LQ			
	1.9 TDI	110		10.00	12.04	PR: 1LQ			
	1.9 TDI 4motion	66		02.99	06.01	PR: 1LQ			
	1.9 TDI 4motion	74		09.00	12.04	PR: 1LQ			
	1.9 TDI 4motion	85		02.99	06.01	PR: 1LQ			
	1.9 TDI 4motion	96		04.01	12.04	PR: 1LQ			
	1.9 TDI 4motion	110		10.00	12.04	PR: 1LQ			
	2.0	85		09.98	12.04	PR: 1LQ			
	2.0 4motion	85		04.00	12.04	PR: 1LQ			
	2.3 V5			09.98	12.04	PR: 1LQ			
	2.3 V5 4motion			02.99	12.04	PR: 1LQ			
	2.8 V6 4motion	150		05.99	12.04	PR: 1LQ			
	1.4 16V			09.98	12.04	PR: 1LN,1ZD,1ZE,1ZH	<b>G2125113</b>		288 25,0 22,0 V L +S +C
	1.6			09.98	12.04	PR: 1LN,1ZD,1ZE,1ZH			
	1.6 16V			02.00	12.04	PR: 1LN,1ZD,1ZE,1ZH			
	1.6 FSI			01.02	12.04	PR: 1LN,1ZD,1ZE,1ZH			
	1.8	92		09.98	12.04	PR: 1LN,1ZD,1ZE,1ZH			
	1.8 4motion	92		02.99	12.04	PR: 1LN,1ZD,1ZE,1ZH			
	1.8 T	110		09.00	12.04	PR: 1LN,1ZD,1ZE,1ZH			
	1.8 T	132		05.02	12.04	PR: 1LN,1ZD,1ZE,1ZH			
	1.9 SDI			09.98	12.04	PR: 1LN,1ZD,1ZE,1ZH			
	1.9 TDI	66		09.98	06.01	PR: 1LN,1ZD,1ZE,1ZH			
	1.9 TDI	74		09.00	12.04	PR: 1LN,1ZD,1ZE,1ZH			
	1.9 TDI	81		09.98	06.01	PR: 1LN,1ZD,1ZE,1ZH			
	1.9 TDI	85		02.99	06.01	PR: 1LN,1ZD,1ZE,1ZH			
	1.9 TDI	96		04.01	12.04	PR: 1LN,1ZD,1ZE,1ZH			
	1.9 TDI	110		10.00	12.04	PR: 1LN,1ZD,1ZE,1ZH			
	1.9 TDI 4motion	66		02.99	06.01	PR: 1LN,1ZD,1ZE,1ZH			
	1.9 TDI 4motion	74		09.00	12.04	PR: 1LN,1ZD,1ZE,1ZH			
	1.9 TDI 4motion	85		02.99	06.01	PR: 1LN,1ZD,1ZE,1ZH			
	1.9 TDI 4motion	96		04.01	12.04	PR: 1LN,1ZD,1ZE,1ZH			
	1.9 TDI 4motion	110		10.00	12.04	PR: 1LN,1ZD,1ZE,1ZH			
	2.0	85		09.98	12.04	PR: 1LN,1ZD,1ZE,1ZH			
	2.0 4motion	85		04.00	12.04	PR: 1LN,1ZD,1ZE,1ZH			
	2.3 V5			09.98	12.04	PR: 1LN,1ZD,1ZE,1ZH			
	2.3 V5 4motion			02.99	12.04	PR: 1LN,1ZD,1ZE,1ZH			
	2.8 V6 4motion	150		05.99	12.04	PR: 1LN,1ZD,1ZE,1ZH			
	1.4 16V			09.98	12.04	PR: 1LJ,1ZQ	<b>G2125123</b>		310 25,0 22,0 V L +C
	1.6			09.98	12.04	PR: 1LJ,1ZQ			
	1.6 16V			02.00	12.04	PR: 1LJ,1ZQ			
	1.6 FSI			01.02	12.04	PR: 1LJ,1ZQ			
	1.8	92		09.98	12.04	PR: 1LJ,1ZQ			
	1.8 4motion	92		02.99	12.04	PR: 1LJ,1ZQ			
	1.8 T	110		09.00	12.04	PR: 1LJ,1ZQ			
	1.8 T	132		05.02	12.04	PR: 1LJ,1ZQ			
	1.9 SDI			09.98	12.04	PR: 1LJ,1ZQ			
	1.9 TDI	66		09.98	06.01	PR: 1LJ,1ZQ			
	1.9 TDI	74		09.00	12.04	PR: 1LJ,1ZQ			
	1.9 TDI	81		09.98	06.01	PR: 1LJ,1ZQ			
	1.9 TDI	85		02.99	06.01	PR: 1LJ,1ZQ			
	1.9 TDI	96		04.01	12.04	PR: 1LJ,1ZQ			
	1.9 TDI	110		10.00	12.04	PR: 1LJ,1ZQ			
1.9 TDI 4motion	66		02.99	06.01	PR: 1LJ,1ZQ				
1.9 TDI 4motion	74		09.00	12.04	PR: 1LJ,1ZQ				
1.9 TDI 4motion	85		02.99	06.01	PR: 1LJ,1ZQ				
1.9 TDI 4motion	96		04.01	12.04	PR: 1LJ,1ZQ				
1.9 TDI 4motion	110		10.00	12.04	PR: 1LJ,1ZQ				
2.0	85		09.98	12.04	PR: 1LJ,1ZQ				
2.0 4motion	85		04.00	12.04	PR: 1LJ,1ZQ				
2.3 V5			09.98	12.04	PR: 1LJ,1ZQ				
2.3 V5 4motion			02.99	12.04	PR: 1LJ,1ZQ				
2.8 V6 4motion	150		05.99	12.04	PR: 1LJ,1ZQ				
	1.4 16V			09.98	12.04	PR: 1KE,1KP,1KT	<b>G1020755</b>		20961 17,1 /Acc/S <b>LUC</b>
	1.6			09.98	12.04	PR: 1KE,1KP,1KT			
	1.6 16V			02.00	12.04	PR: 1KE,1KP,1KT			
	1.6 FSI			01.02	12.04	PR: 1KE,1KP,1KT			
	1.8	92		09.98	12.04	PR: 1KE,1KP,1KT			
	1.8 4motion	92		02.99	12.04	PR: 1KE,1KP,1KT			
	1.8 T	110		09.00	12.04	PR: 1KE,1KP,1KT			
	1.8 T	132		05.02	12.04	PR: 1KE,1KP,1KT			
	1.9 SDI			09.98	12.04	PR: 1KE,1KP,1KT			
	1.9 TDI	66		09.98	06.01	PR: 1KE,1KP,1KT			
	1.9 TDI	74		09.00	12.04	PR: 1KE,1KP,1KT			
	1.9 TDI	81		09.98	06.01	PR: 1KE,1KP,1KT			
	1.9 TDI	85		02.99	06.01	PR: 1KE,1KP,1KT			
	1.9 TDI	96		04.01	12.04	PR: 1KE,1KP,1KT			
	1.9 TDI	110		10.00	12.04	PR: 1KE,1KP,1KT			
1.9 TDI 4motion	66		02.99	06.01	PR: 1KE,1KP,1KT				
1.9 TDI 4motion	74		09.00	12.04	PR: 1KE,1KP,1KT				
1.9 TDI 4motion	85		02.99	06.01	PR: 1KE,1KP,1KT				
1.9 TDI 4motion	96		04.01	12.04	PR: 1KE,1KP,1KT				
1.9 TDI 4motion	110		10.00	12.04	PR: 1KE,1KP,1KT				
2.0	85		09.98	12.04	PR: 1KE,1KP,1KT				
2.0 4motion	85		04.00	12.04	PR: 1KE,1KP,1KT				





**VOLKSWAGEN BORA (98-04)**

	2.3 V5		09.98	12.04	PR: 1KE,1KP,1KT	G1020755		20961 17,1 /Acc/S	LUC					
	2.3 V5 4motion		02.99	12.04	PR: 1KE,1KP,1KT									
	2.8 V6 4motion	150	05.99	12.04	PR: 1KE,1KP,1KT									
	1.4 16V		09.98	12.04	PR: 1KY	G1020676		20961 15,8 /S	LUC					
	1.6		09.98	12.04	PR: 1KY									
	1.6 16V		02.00	12.04	PR: 1KY									
	1.6 FSI		01.02	12.04	PR: 1KY									
	1.8	92	09.98	12.04	PR: 1KY									
	1.8 4motion	92	02.99	12.04	PR: 1KY									
	1.8 T	110	09.00	12.04	PR: 1KY									
	1.8 T	132	05.02	12.04	PR: 1KY									
	1.9 SDI		09.98	12.04	PR: 1KY									
	1.9 TDI	66	09.98	06.01	PR: 1KY									
	1.9 TDI	74	09.00	12.04	PR: 1KY									
	1.9 TDI	81	09.98	06.01	PR: 1KY									
	1.9 TDI	85	02.99	06.01	PR: 1KY									
	1.9 TDI	96	04.01	12.04	PR: 1KY									
	1.9 TDI	110	10.00	12.04	PR: 1KY									
	1.9 TDI 4motion	66	02.99	06.01	PR: 1KY									
	1.9 TDI 4motion	74	09.00	12.04	PR: 1KY									
	1.9 TDI 4motion	85	02.99	06.01	PR: 1KY									
	1.9 TDI 4motion	96	04.01	12.04	PR: 1KY									
	1.9 TDI 4motion	110	10.00	12.04	PR: 1KY									
	2.0	85	09.98	12.04	PR: 1KY									
	2.0 4motion	85	04.00	12.04	PR: 1KY									
	2.3 V5		09.98	12.04	PR: 1KY									
	2.3 V5 4motion		02.99	12.04	PR: 1KY									
	2.8 V6 4motion	150	05.99	12.04	PR: 1KY									
		1.4 16V		09.98	12.04					PR: 1KU,2EE	G1020492		23554 17,1 /WD/S	LUC
		1.6		09.98	12.04					PR: 1KU,2EE				
		1.6 16V		02.00	12.04					PR: 1KU,2EE				
1.6 FSI			01.02	12.04	PR: 1KU,2EE									
1.8		92	09.98	12.04	PR: 1KU,2EE									
1.8 4motion		92	02.99	12.04	PR: 1KU,2EE									
1.8 T		110	09.00	12.04	PR: 1KU,2EE									
1.8 T		132	05.02	12.04	PR: 1KU,2EE									
1.9 SDI			09.98	12.04	PR: 1KU,2EE									
1.9 TDI		66	09.98	06.01	PR: 1KU,2EE									
1.9 TDI		74	09.00	12.04	PR: 1KU,2EE									
1.9 TDI		81	09.98	06.01	PR: 1KU,2EE									
1.9 TDI		85	02.99	06.01	PR: 1KU,2EE									
1.9 TDI		96	04.01	12.04	PR: 1KU,2EE									
1.9 TDI		110	10.00	12.04	PR: 1KU,2EE									
1.9 TDI 4motion		66	02.99	06.01	PR: 1KU,2EE									
1.9 TDI 4motion		74	09.00	12.04	PR: 1KU,2EE									
1.9 TDI 4motion		85	02.99	06.01	PR: 1KU,2EE									
1.9 TDI 4motion		96	04.01	12.04	PR: 1KU,2EE									
1.9 TDI 4motion		110	10.00	12.04	PR: 1KU,2EE									
2.0		85	09.98	12.04	PR: 1KU,2EE									
2.0 4motion		85	04.00	12.04	PR: 1KU,2EE									
2.3 V5			09.98	12.04	PR: 1KU,2EE									
2.3 V5 4motion			02.99	12.04	PR: 1KU,2EE									
2.8 V6 4motion		150	05.99	12.04	PR: 1KU,2EE									
		1.4 16V		09.98	12.04	PR: 1KP,1KT	G2109123		230 9,0 7,0 +S +C					
		1.6		09.98	12.04	PR: 1KP,1KT								
		1.6 16V		02.00	12.04	PR: 1KP,1KT								
	1.6 FSI		01.02	12.04	PR: 1KP,1KT									
	1.8	92	09.98	12.04	PR: 1KP,1KT									
	1.8 4motion	92	02.99	12.04	PR: 1KP,1KT									
	1.8 T	110	09.00	12.04	PR: 1KP,1KT									
	1.8 T	132	05.02	12.04	PR: 1KP,1KT									
	1.9 SDI		09.98	12.04	PR: 1KP,1KT									
	1.9 TDI	66	09.98	06.01	PR: 1KP,1KT									
	1.9 TDI	74	09.00	12.04	PR: 1KP,1KT									
	1.9 TDI	81	09.98	06.01	PR: 1KP,1KT									
	1.9 TDI	85	02.99	06.01	PR: 1KP,1KT									
	1.9 TDI	96	04.01	12.04	PR: 1KP,1KT									
	1.9 TDI	110	10.00	12.04	PR: 1KP,1KT									
	1.9 TDI 4motion	66	02.99	06.01	PR: 1KP,1KT									
	1.9 TDI 4motion	74	09.00	12.04	PR: 1KP,1KT									
	1.9 TDI 4motion	85	02.99	06.01	PR: 1KP,1KT									
	1.9 TDI 4motion	96	04.01	12.04	PR: 1KP,1KT									
	1.9 TDI 4motion	110	10.00	12.04	PR: 1KP,1KT									
	2.0	85	09.98	12.04	PR: 1KP,1KT									
	2.0 4motion	85	04.00	12.04	PR: 1KP,1KT									
	2.3 V5		09.98	12.04	PR: 1KP,1KT									
	2.3 V5 4motion		02.99	12.04	PR: 1KP,1KT									
	2.8 V6 4motion	150	05.99	12.04	PR: 1KP,1KT									
		1.4 16V		09.98	12.04	PR: 1KE					G2109133		239 8,9 7,0 +S +C	
		1.6		09.98	12.04	PR: 1KE								
		1.6 16V		02.00	12.04	PR: 1KE								
1.6 FSI			01.02	12.04	PR: 1KE									
1.8		92	09.98	12.04	PR: 1KE									
1.8 4motion		92	02.99	12.04	PR: 1KE									
1.8 T		110	09.00	12.04	PR: 1KE									
1.8 T		132	05.02	12.04	PR: 1KE									
1.9 SDI			09.98	12.04	PR: 1KE									



### VOLKSWAGEN BORA (98-04)

	1.9 TDI	66		09.98	06.01	PR: 1KE	<b>G2109133</b>		239 8,9 7,0 +S +C			
	1.9 TDI	74		09.98	12.04	PR: 1KE						
	1.9 TDI	81		09.98	06.01	PR: 1KE						
	1.9 TDI	85		02.99	06.01	PR: 1KE						
	1.9 TDI	96		04.01	12.04	PR: 1KE						
	1.9 TDI	110		10.00	12.04	PR: 1KE						
	1.9 TDI 4motion	66		02.99	06.01	PR: 1KE						
	1.9 TDI 4motion	74		09.00	12.04	PR: 1KE						
	1.9 TDI 4motion	85		02.99	06.01	PR: 1KE						
	1.9 TDI 4motion	96		04.01	12.04	PR: 1KE						
	1.9 TDI 4motion	110		10.00	12.04	PR: 1KE						
	2.0	85		09.98	12.04	PR: 1KE						
	2.0 4motion	85		04.00	12.04	PR: 1KE						
	2.3 V5			09.98	12.04	PR: 1KE						
	2.3 V5 4motion			02.99	12.04	PR: 1KE						
	2.8 V6 4motion	150		05.99	12.04	PR: 1KE						
	1.4 16V			09.98	12.04	PR: 1KU,1KY,2EE				<b>G2122163</b>		256 22,0 20,0 V L +C
	1.6			09.98	12.04	PR: 1KU,1KY,2EE						
	1.6 16V			02.00	12.04	PR: 1KU,1KY,2EE						
	1.6 FSI			01.02	12.04	PR: 1KU,1KY,2EE						
	1.8	92		09.98	12.04	PR: 1KU,1KY,2EE						
1.8 4motion	92		02.99	12.04	PR: 1KU,1KY,2EE							
1.8 T	110		09.00	12.04	PR: 1KU,1KY,2EE							
1.8 T	132		05.02	12.04	PR: 1KU,1KY,2EE							
1.9 SDI			09.98	12.04	PR: 1KU,1KY,2EE							
1.9 TDI	66		09.98	06.01	PR: 1KU,1KY,2EE							
1.9 TDI	74		09.00	12.04	PR: 1KU,1KY,2EE							
1.9 TDI	81		09.98	06.01	PR: 1KU,1KY,2EE							
1.9 TDI	85		02.99	06.01	PR: 1KU,1KY,2EE							
1.9 TDI	96		04.01	12.04	PR: 1KU,1KY,2EE							
1.9 TDI	110		10.00	12.04	PR: 1KU,1KY,2EE							
1.9 TDI 4motion	66		02.99	06.01	PR: 1KU,1KY,2EE							
1.9 TDI 4motion	74		09.00	12.04	PR: 1KU,1KY,2EE							
1.9 TDI 4motion	85		02.99	06.01	PR: 1KU,1KY,2EE							
1.9 TDI 4motion	96		04.01	12.04	PR: 1KU,1KY,2EE							
1.9 TDI 4motion	110		10.00	12.04	PR: 1KU,1KY,2EE							
2.0	85		09.98	12.04	PR: 1KU,1KY,2EE							
2.0 4motion	85		04.00	12.04	PR: 1KU,1KY,2EE							
2.3 V5			09.98	12.04	PR: 1KU,1KY,2EE							
2.3 V5 4motion			02.99	12.04	PR: 1KU,1KY,2EE							
2.8 V6 4motion	150		05.99	12.04	PR: 1KU,1KY,2EE							

### VOLKSWAGEN CADDY II (96-03)

	1.4		9K-T-514500	11.95			<b>G1020274</b>		20168 19,3 /S	LUC
	1.6		9K-T-514500	11.95						
	1.9 D		9K-T-514500	11.95						
	1.9 SDI		9K-T-514500	11.95						
	1.4	9K-T-514501			06.03					
1.6	9K-T-514501			06.03						
1.7 SDI			07.96	06.03						
1.9 D	9K-T-514501			06.03						
1.9 SDI	9K-T-514501			06.03						
1.9 TDI			09.96	06.03						
	1.4		9K-T-514500	11.95			<b>G2113178</b>		256 12,9 11,0 +S +C	
	1.6		9K-T-514500	11.95						
	1.9 D		9K-T-514500	11.95						
	1.9 SDI		9K-T-514500	11.95						
	1.4	9K-T-514501			06.03					
1.6	9K-T-514501			06.03						
1.7 SDI			07.96	06.03						
1.9 D	9K-T-514501			06.03						
1.9 SDI	9K-T-514501			06.03						
1.9 TDI			09.96	06.03						

### VOLKSWAGEN CADDY III (04-)

	1.2 TSI			09.10		PR: 1ZF,1ZM	<b>G1020463</b>		23131 19,7 +/WI	VW				
	1.4			02.04		PR: 1ZF,1ZM								
	1.4 16V	59		05.06		PR: 1ZF,1ZM								
	1.6			04.04		PR: 1ZF,1ZM								
	1.6 TDI			08.10		PR: 1ZF,1ZM								
	1.9 TDI	55		09.05		PR: 1ZF,1ZM								
	1.9 TDI	77		02.04		PR: 1ZF,1ZM								
	1.9 TDI 4motion	77		05.08		PR: 1ZF,1ZM								
	2.0 Eco Fuel	80		04.06		PR: 1ZF,1ZM								
	2.0 SDI	51		02.04		PR: 1ZF,1ZM								
	2.0 TDI	81		10.10		PR: 1ZF,1ZM								
	2.0 TDI	103		09.07		PR: 1ZF,1ZM								
	2.0 TDI	125		05.12		PR: 1ZF,1ZM								
	2.0 TDI 4motion	81		10.10		PR: 1ZF,1ZM								
	1.2 TSI			09.10		PR: 1ZE,1LJ,1ZA					<b>G1020680</b>		23587 20,6 +/WI	ATE
	1.4	55		02.04		PR: 1ZE,1LJ,1ZA								
	1.4 16V	59		05.06		PR: 1ZE,1LJ,1ZA								
1.6			04.04		PR: 1ZE,1LJ,1ZA									
1.6 TDI			08.10		PR: 1ZE,1LJ,1ZA									
1.9 TDI	55		09.05		PR: 1ZE,1LJ,1ZA									
1.9 TDI	77		02.04		PR: 1ZE,1LJ,1ZA									
1.9 TDI 4motion	77		05.08		PR: 1ZE,1LJ,1ZA									





















**VOLKSWAGEN CADDY III (04-)**

	2.0 Eco Fuel 2.0 SDI 2.0 TDI 2.0 TDI 2.0 TDI 2.0 TDI 4motion	80 51 81 103 125 81		04.06 02.04 10.10 09.07 05.12 10.10	PR: 1ZE,1LJ,1ZA PR: 1ZE,1LJ,1ZA PR: 1ZE,1LJ,1ZA PR: 1ZE,1LJ,1ZA PR: 1ZE,1LJ,1ZA PR: 1ZE,1LJ,1ZA	G1020680		23587 20,6 +/Wl	ATE
	1.2 TSI 1.4 1.4 16V 1.6 1.6 TDI 1.9 TDI 1.9 TDI 1.9 TDI 4motion 2.0 Eco Fuel 2.0 SDI 2.0 TDI 2.0 TDI 2.0 TDI 2.0 TDI 4motion	55 59 55 77 77 80 51 81 103 125 81		09.10 02.04 05.06 04.04 08.10 09.05 02.04 05.08 04.06 02.04 10.10 09.07 05.12 10.10	PR: 1ZF,1ZM PR: 1ZF,1ZM PR: 1ZF,1ZM PR: 1ZF,1ZM PR: 1ZF,1ZM PR: 1ZF,1ZM PR: 1ZF,1ZM PR: 1ZF,1ZM PR: 1ZF,1ZM PR: 1ZF,1ZM PR: 1ZF,1ZM PR: 1ZF,1ZM PR: 1ZF,1ZM PR: 1ZF,1ZM	G2122210		280 22,0 19,0 V L +S +C	
	1.2 TSI 1.4 1.4 16V 1.6 1.6 TDI 1.9 TDI 1.9 TDI 1.9 TDI 4motion 2.0 Eco Fuel 2.0 SDI 2.0 TDI 2.0 TDI 2.0 TDI 2.0 TDI 4motion	55 59 55 77 77 80 51 81 103 125 81		09.10 02.04 05.06 04.04 08.10 09.05 02.04 05.08 04.06 02.04 10.10 09.07 05.12 10.10	PR: 1ZE PR: 1ZE PR: 1ZE PR: 1ZE PR: 1ZE PR: 1ZE PR: 1ZE PR: 1ZE PR: 1ZE PR: 1ZE PR: 1ZE PR: 1ZE PR: 1ZE	G2125145		288 25,0 22,0 V L +S +C	
	1.2 TSI 1.4 1.4 16V 1.6 1.6 TDI 1.9 TDI 1.9 TDI 1.9 TDI 4motion 2.0 Eco Fuel 2.0 SDI 2.0 TDI 2.0 TDI 2.0 TDI 2.0 TDI 4motion	55 59 55 77 77 80 51 81 103 125 81		09.10 02.04 05.06 04.04 08.10 09.05 02.04 05.08 04.06 02.04 10.10 09.07 05.12 10.10	PR: 1LJ,1ZA PR: 1LJ,1ZA PR: 1LJ,1ZA PR: 1LJ,1ZA PR: 1LJ,1ZA PR: 1LJ,1ZA PR: 1LJ,1ZA PR: 1LJ,1ZA PR: 1LJ,1ZA PR: 1LJ,1ZA PR: 1LJ,1ZA PR: 1LJ,1ZA PR: 1LJ,1ZA	G2125158		312 25,0 22,0 V L +S +C	
	1.4 1.4 16V 1.6 1.9 TDI 1.9 TDI 2.0 Eco Fuel 2.0 SDI 2.0 TDI	55 59 55 77 77 80 51 103		02.04 05.06 04.04 09.05 02.04 04.06 02.04 09.07	11.07 11.07 11.07 11.07 11.07 11.07 11.07 11.07	G1020682		23914 17,1 /WD/Acc/S	LUC
	1.2 TSI 1.4 1.4 16V 1.6 1.6 TDI 1.9 TDI 1.9 TDI 1.9 TDI 4motion 2.0 Eco Fuel 2.0 SDI 2.0 TDI 2.0 TDI 2.0 TDI 2.0 TDI 4motion	55 59 55 77 77 80 51 81 103 125 81		09.10 12.07 12.07 12.07 08.10 12.07 12.07 05.08 12.07 12.07 10.10 12.07 05.12 10.10	PR: 1ZF,2E2 PR: 1ZF,2E2 PR: 1ZF,2E2 PR: 1ZF,2E2 PR: 1ZF,2E2 PR: 1ZF,2E2 PR: 1ZF,2E2 PR: 1ZF,2E2 PR: 1ZF,2E2 PR: 1ZF,2E2 PR: 1ZF,2E2 PR: 1ZF,2E2 PR: 1ZF,2E2	G1020492		23554 17,1 /WD/S	LUC
	1.2 TSI 1.4 1.4 16V 1.6 1.6 TDI 1.9 TDI 1.9 TDI 1.9 TDI 4motion 2.0 Eco Fuel 2.0 SDI 2.0 TDI 2.0 TDI 2.0 TDI 4motion	55 59 55 77 77 80 51 81 103 125 81	2K-B-200 000 2K-B-200 000 2K-B-200 000 2K-B-200 000 2K-B-200 000 2K-B-200 000 2K-B-200 000 2K-B-200 000 2K-B-200 000 2K-B-200 000 2K-B-200 000 2K-B-200 000 2K-B-200 000	09.10 12.07 12.07 12.07 08.10 12.07 12.07 05.08 12.07 12.07 10.10 12.07 10.10	PR: 1ZE,1LJ PR: 1ZE,1LJ PR: 1ZE,1LJ PR: 1ZE,1LJ PR: 1ZE,1LJ PR: 1ZE,1LJ PR: 1ZE,1LJ PR: 1ZE,1LJ PR: 1ZE,1LJ PR: 1ZE,1LJ PR: 1ZE,1LJ PR: 1ZE,1LJ PR: 1ZE,1LJ	G1020682		23914 17,1 /WD/Acc/S	LUC

VOLKSWAGEN CADDY III (04-)		VOLKSWAGEN CADDY Pickup (97-02)		VOLKSWAGEN CC COUPE (11-)			
	1.4 1.4 16V 1.6 1.9 TDI 1.9 TDI 2.0 Eco Fuel 2.0 SDI 2.0 TDI	55 59 55 77 80 51 103		02.04 11.07 05.06 11.07 04.04 11.07 09.05 11.07 02.04 11.07 04.06 11.07 02.04 11.07 09.07 11.07	G2112158	256 12,0 10,0 +C	
	1.2 TSI 1.4 1.4 16V 1.6 1.6 TDI 1.9 TDI 1.9 TDI 1.9 TDI 4motion 2.0 Eco Fuel 2.0 SDI 2.0 TDI 2.0 TDI 2.0 TDI 2.0 TDI 4motion	55 59 55 77 77 80 51 81 103 125 81		09.10 12.07 12.07 12.07 08.10 12.07 12.07 12.07 05.08 12.07 12.07 10.10 12.07 05.12 10.10	PR: 1ZF,2E2 PR: 1ZF,2E2 PR: 1ZF,2E2 PR: 1ZF,2E2 PR: 1ZF,2E2 PR: 1ZF,2E2 PR: 1ZF,2E2 PR: 1ZF,2E2 PR: 1ZF,2E2 PR: 1ZF,2E2 PR: 1ZF,2E2 PR: 1ZF,2E2 PR: 1ZF,2E2 PR: 1ZF,2E2 PR: 1ZF,2E2	G2110277	253 10,0 8,0 +S +C
	1.2 TSI 1.4 1.4 16V 1.6 1.6 TDI 1.9 TDI 1.9 TDI 1.9 TDI 4motion 2.0 Eco Fuel 2.0 SDI 2.0 TDI 2.0 TDI 2.0 TDI 4motion	55 59 55 77 77 80 51 81 103 81	2K-B-200 000 2K-B-200 000 2K-B-200 000 2K-B-200 000 2K-B-200 000 2K-B-200 000 2K-B-200 000 2K-B-200 000 2K-B-200 000 2K-B-200 000 2K-B-200 000 2K-B-200 000 2K-B-200 000 2K-B-200 000 2K-B-200 000	09.10 12.07 12.07 12.07 08.10 12.07 12.07 05.08 12.07 12.07 10.10 12.07 10.10 12.07	PR: 1ZE,1LJ PR: 1ZE,1LJ PR: 1ZE,1LJ PR: 1ZE,1LJ PR: 1ZE,1LJ PR: 1ZE,1LJ PR: 1ZE,1LJ PR: 1ZE,1LJ PR: 1ZE,1LJ PR: 1ZE,1LJ PR: 1ZE,1LJ PR: 1ZE,1LJ PR: 1ZE,1LJ PR: 1ZE,1LJ PR: 1ZE,1LJ	G2112158	256 12,0 10,0 +C
	1.2 TSI 1.4 1.4 16V 1.6 1.6 TDI 1.9 TDI 1.9 TDI 1.9 TDI 4motion 2.0 Eco Fuel 2.0 SDI 2.0 TDI 2.0 TDI 2.0 TDI 4motion	55 59 55 77 77 80 51 81 103 125 81	2K-B-200 001 2K-B-200 001 2K-B-200 001 2K-B-200 001 2K-B-200 001 2K-B-200 001 2K-B-200 001 2K-B-200 001 2K-B-200 001 2K-B-200 001 2K-B-200 001 2K-B-200 001 2K-B-200 001 2K-B-200 001 2K-B-200 001		PR: 1ZA,1ZE,2E3 PR: 1ZA,1ZE,2E3 PR: 1ZA,1ZE,2E3 PR: 1ZA,1ZE,2E3 PR: 1ZA,1ZE,2E3 PR: 1ZA,1ZE,2E3 PR: 1ZA,1ZE,2E3 PR: 1ZA,1ZE,2E3 PR: 1ZA,1ZE,2E3 PR: 1ZA,1ZE,2E3 PR: 1ZA,1ZE,2E3 PR: 1ZA,1ZE,2E3 PR: 1ZA,1ZE,2E3 PR: 1ZA,1ZE,2E3 PR: 1ZA,1ZE,2E3	G2110356	272 9,7 8,0 +S +C
	1.6 1.9 D			10.97 12.00 10.97 12.00	G2113182	236 12,8 11,4 +C	
	1.4 TSI 1.8 TSI 2.0 TDI 2.0 TDI 2.0 TDI 2.0 TDI 2.0 TDI 4motion 2.0 TDI 4motion 2.0 TDI 4motion 2.0 TSI 3.6 V6 4motion	118 118 100 103 125 130 103 125 130 155 220		11.11 11.11 11.11 11.11 11.11 12.12 11.11 11.11 12.12 11.11 11.11 11.11	PR: 1ZM,1ZG PR: 1ZM,1ZG PR: 1ZM,1ZG PR: 1ZM,1ZG PR: 1ZM,1ZG PR: 1ZM,1ZG PR: 1ZM,1ZG PR: 1ZM,1ZG PR: 1ZM,1ZG PR: 1ZM,1ZG PR: 1ZM,1ZG PR: 1ZM,1ZG	G1020680	23587 20,6 +/WI ATE
	1.4 TSI 1.8 TSI 2.0 TDI 2.0 TDI 2.0 TDI 2.0 TDI 2.0 TDI 4motion 2.0 TDI 4motion 2.0 TDI 4motion 2.0 TSI 3.6 V6 4motion	118 118 100 103 125 130 103 125 130 155 220		11.11 11.11 11.11 11.11 11.11 12.12 11.11 11.11 12.12 11.11 11.11 11.11	PR: 1ZM,1ZG PR: 1ZM,1ZG PR: 1ZM,1ZG PR: 1ZM,1ZG PR: 1ZM,1ZG PR: 1ZM,1ZG PR: 1ZM,1ZG PR: 1ZM,1ZG PR: 1ZM,1ZG PR: 1ZM,1ZG PR: 1ZM,1ZG PR: 1ZM,1ZG	G2125158	312 25,0 22,0 V L +S +C
	1.4 TSI 1.8 TSI 2.0 TDI 2.0 TDI 2.0 TDI 2.0 TDI 2.0 TDI 4motion 2.0 TDI 4motion 2.0 TDI 4motion	118 118 100 103 125 130 103 125 130		11.11 11.11 11.11 11.11 12.12 11.11 11.11 11.11 12.12	PR: 1KW PR: 1KW PR: 1KW PR: 1KW PR: 1KW PR: 1KW PR: 1KW PR: 1KW PR: 1KW	G1020993	electric parking brake <sup>1)</sup> 24483 16,9 /Acc/S LUC

<sup>1)</sup> fr.di stazionamento elettrico / frein à main électrique / freno de mano eléctrico / elektrishe Feststellbremse

												
<b>VOLKSWAGEN CC COUPE (11-)</b>												
	2.0 TSI	155	11.11	PR: 1KW	G1020993	electric parking brake <sup>1)</sup>	24483 16,9 /Acc/S	LUC				
	3.6 V6 4motion	220	11.11	PR: 1KW								
	1.4 TSI	118	11.11	PR: 2EA	G1020734	electric parking brake <sup>1)</sup>	23914 17,1 /WD/Acc/S	LUC				
	1.8 TSI	118	11.11	PR: 2EA								
	2.0 TDI	100	11.11	PR: 2EA								
	2.0 TDI	103	11.11	PR: 2EA								
	2.0 TDI	125	11.11	PR: 2EA								
	2.0 TDI	130	12.12	PR: 2EA								
	2.0 TDI 4motion	103	11.11	PR: 2EA								
	2.0 TDI 4motion	125	11.11	PR: 2EA								
2.0 TDI 4motion	130	12.12	PR: 2EA									
2.0 TSI	155	11.11	PR: 2EA									
3.6 V6 4motion	220	11.11	PR: 2EA									
	1.4 TSI	118	11.11	PR: 1KW	G2112169	electric parking brake <sup>1)</sup>	282 12,0 10,0 +S +C					
	1.8 TSI	118	11.11	PR: 1KW								
	2.0 TDI	100	11.11	PR: 1KW								
	2.0 TDI	103	11.11	PR: 1KW								
	2.0 TDI	125	11.11	PR: 1KW								
	2.0 TDI	130	12.12	PR: 1KW								
	2.0 TDI 4motion	103	11.11	PR: 1KW								
	2.0 TDI 4motion	125	11.11	PR: 1KW								
	2.0 TDI 4motion	130	12.12	PR: 1KW								
	2.0 TSI	155	11.11	PR: 1KW								
3.6 V6 4motion	220	11.11	PR: 1KW									
<b>VOLKSWAGEN CRAFTER (06-)</b>												
	2.0 TDI 4motion	120	11.11	PR: OWC, OWL	G1020769		29192 20,7 /WD/Acc	BRE				
	2.0 TDI BlueMotion	80	07.11	PR: OWC, OWL								
	2.0 TDI BlueMotion	100	07.11	PR: OWC, OWL								
	2.0 TDI BlueMotion	120	07.11	PR: OWC, OWL								
	2.5 TDI	65	04.06	PR: OWC, OWL								
	2.5 TDI	80	04.06	PR: OWC, OWL								
	2.5 TDI	100	04.06	PR: OWC, OWL								
	2.5 TDI	120	04.06	PR: OWC, OWL								
	2.5 TDI	65	04.06	06.11 PR: OWF					G1020770		29200 21,0 /WD/Acc	BRE
	2.5 TDI	80	04.06	06.11 PR: OWF								
2.5 TDI	100	04.06	06.11 PR: OWF									
2.5 TDI	120	04.06	06.11 PR: OWF									
2.0 TDI 4motion	120	11.11	PR: OWF	G1020770		29200 21,0 /WD/Acc	BRE					
2.0 TDI BlueMotion	80	07.11	PR: OWF									
2.0 TDI BlueMotion	100	07.11	PR: OWF									
2.0 TDI BlueMotion	120	07.11	PR: OWF									
2.5 TDI	65	07.11	PR: OWF									
2.5 TDI	80	07.11	PR: OWF									
2.5 TDI	100	07.11	PR: OWF									
2.5 TDI	120	07.11	PR: OWF									
	2.0 TDI 4motion	120	11.11	PR: OWC, OWF, OWL	G2128203		300 28,0 25,0 V L +S +C					
	2.0 TDI BlueMotion	80	07.11	PR: OWC, OWF, OWL								
	2.0 TDI BlueMotion	100	07.11	PR: OWC, OWF, OWL								
	2.0 TDI BlueMotion	120	07.11	PR: OWC, OWF, OWL								
	2.5 TDI	65	04.06	PR: OWC, OWF, OWL								
	2.5 TDI	80	04.06	PR: OWC, OWF, OWL								
	2.5 TDI	100	04.06	PR: OWC, OWF, OWL								
	2.5 TDI	120	04.06	PR: OWC, OWF, OWL								
	2.0 TDI 4motion	120	11.11	PR: OWC, OWL	G1020766		29190 20,2 +/WD/S	BOS				
	2.0 TDI BlueMotion	80	07.11	PR: OWC, OWL								
	2.0 TDI BlueMotion	100	07.11	PR: OWC, OWL								
	2.0 TDI BlueMotion	120	07.11	PR: OWC, OWL								
	2.5 TDI	65	04.06	PR: OWC, OWL								
	2.5 TDI	80	04.06	PR: OWC, OWL								
	2.5 TDI	100	04.06	PR: OWC, OWL								
	2.5 TDI	120	04.06	PR: OWC, OWL								
	2.0 TDI 4motion	120	11.11	PR: OWF					G1020940		29217 20,5 /S	BOS
	2.0 TDI BlueMotion	80	07.11	PR: OWF								
2.0 TDI BlueMotion	100	07.11	PR: OWF									
2.0 TDI BlueMotion	120	07.11	PR: OWF									
2.5 TDI	65	04.06	PR: OWF									
2.5 TDI	80	04.06	PR: OWF									
2.5 TDI	100	04.06	PR: OWF									
2.5 TDI	120	04.06	PR: OWF									
<b>VOLKSWAGEN EOS (06-)</b>												
	1.4 TSI	90	10.07	PR: 1LJ,1ZA,1ZD,1ZE	G1020680		23587 20,6 +/Wl	ATE				
	1.4 TSI	92	11.13	PR: 1LJ,1ZA,1ZD,1ZE								
	1.4 TSI	110	11.13	PR: 1LJ,1ZA,1ZD,1ZE								
	1.4 TSI	118	05.08	PR: 1LJ,1ZA,1ZD,1ZE								
	1.6 FSI	85	05.06	PR: 1LJ,1ZA,1ZD,1ZE								
	2.0 FSI	110	05.06	PR: 1LJ,1ZA,1ZD,1ZE								
	2.0 TDI	100	11.10	PR: 1LJ,1ZA,1ZD,1ZE								
	2.0 TDI	103	05.06	PR: 1LJ,1ZA,1ZD,1ZE								
	2.0 TDI 16V	103	05.08	PR: 1LJ,1ZA,1ZD,1ZE								
	2.0 TFSI	147	05.06	PR: 1LJ,1ZA,1ZD,1ZE								
	2.0 TFSI	162	11.13	PR: 1LJ,1ZA,1ZD,1ZE								
	2.0 TSI	155	11.09	PR: 1LJ,1ZA,1ZD,1ZE								
	3.2 V6	184	05.06	PR: 1LJ,1ZA,1ZD,1ZE								
3.6 V6	191	05.09	PR: 1LJ,1ZA,1ZD,1ZE									

<sup>1)</sup> fr. di stazionamento elettrico / frein à main électrique / freno de mano eléctrico / elektrische Feststellbremse



**VOLKSWAGEN EOS (06-)**

	1.4 TSI	90	10.07	PR: 1LK	G1020753	23801 20,3 +/Wl	ATE
	1.4 TSI	92	11.13	PR: 1LK			
	1.4 TSI	110	11.13	PR: 1LK			
	1.4 TSI	118	05.08	PR: 1LK			
	1.6 FSI	85	05.06	PR: 1LK			
	2.0 FSI	110	05.06	PR: 1LK			
	2.0 TDI	100	11.10	PR: 1LK			
	2.0 TDI	103	05.06	PR: 1LK			
	2.0 TDI 16V	103	05.08	PR: 1LK			
	2.0 TFSI	147	05.06	PR: 1LK			
	2.0 TFSI	162	11.13	PR: 1LK			
2.0 TSI	155	11.09	PR: 1LK				
3.2 V6	184	05.06	PR: 1LK				
3.6 V6	191	05.09	PR: 1LK				
	1.4 TSI	90	10.07	PR: 1ZE	G2125145	288 25,0 22,0 V L +S +C	
	1.4 TSI	92	11.13	PR: 1ZE			
	1.4 TSI	110	11.13	PR: 1ZE			
	1.4 TSI	118	05.08	PR: 1ZE			
	1.6 FSI	85	05.06	PR: 1ZE			
	2.0 FSI	110	05.06	PR: 1ZE			
	2.0 TDI	100	11.10	PR: 1ZE			
	2.0 TDI	103	05.06	PR: 1ZE			
	2.0 TDI 16V	103	05.08	PR: 1ZE			
	2.0 TFSI	147	05.06	PR: 1ZE			
	2.0 TFSI	162	11.13	PR: 1ZE			
2.0 TSI	155	11.09	PR: 1ZE				
3.2 V6	184	05.06	PR: 1ZE				
3.6 V6	191	05.09	PR: 1ZE				
	1.4 TSI	90	10.07	PR: 1LJ,1ZA,1ZD	G2125158	312 25,0 22,0 V L +S +C	
	1.4 TSI	92	11.13	PR: 1LJ,1ZA,1ZD			
	1.4 TSI	110	11.13	PR: 1LJ,1ZA,1ZD			
	1.4 TSI	118	05.08	PR: 1LJ,1ZA,1ZD			
	1.6 FSI	85	05.06	PR: 1LJ,1ZA,1ZD			
	2.0 FSI	110	05.06	PR: 1LJ,1ZA,1ZD			
	2.0 TDI	100	11.10	PR: 1LJ,1ZA,1ZD			
	2.0 TDI	103	05.06	PR: 1LJ,1ZA,1ZD			
	2.0 TDI 16V	103	05.08	PR: 1LJ,1ZA,1ZD			
	2.0 TFSI	147	05.06	PR: 1LJ,1ZA,1ZD			
	2.0 TFSI	162	11.13	PR: 1LJ,1ZA,1ZD			
2.0 TSI	155	11.09	PR: 1LJ,1ZA,1ZD				
3.2 V6	184	05.06	PR: 1LJ,1ZA,1ZD				
3.6 V6	191	05.09	PR: 1LJ,1ZA,1ZD				
	1.4 TSI	90	10.07	PR: 1LK	G2130115	345 30,0 27,0 V L +C	
	1.4 TSI	92	11.13	PR: 1LK			
	1.4 TSI	110	11.13	PR: 1LK			
	1.4 TSI	118	05.08	PR: 1LK			
	1.6 FSI	85	05.06	PR: 1LK			
	2.0 FSI	110	05.06	PR: 1LK			
	2.0 TDI	100	11.10	PR: 1LK			
	2.0 TDI	103	05.06	PR: 1LK			
	2.0 TDI 16V	103	05.08	PR: 1LK			
	2.0 TFSI	147	05.06	PR: 1LK			
	2.0 TFSI	162	11.13	PR: 1LK			
2.0 TSI	155	11.09	PR: 1LK				
3.2 V6	184	05.06	PR: 1LK				
3.6 V6	191	05.09	PR: 1LK				
	1.4 TSI	90	10.07	PR: 1KD	G1020492	23554 17,1 /WD/S	LUC
	1.4 TSI	92	11.13	PR: 1KD			
	1.4 TSI	110	11.13	PR: 1KD			
	1.4 TSI	118	05.08	PR: 1KD			
	1.6 FSI	85	05.06	PR: 1KD			
	2.0 FSI	110	05.06	PR: 1KD			
	2.0 TDI	100	11.10	PR: 1KD			
	2.0 TDI	103	05.06	PR: 1KD			
	2.0 TDI 16V	103	05.08	PR: 1KD			
	2.0 TFSI	147	05.06	PR: 1KD			
	2.0 TFSI	162	11.13	PR: 1KD			
2.0 TSI	155	11.09	PR: 1KD				
3.2 V6	184	05.06	PR: 1KD				
3.6 V6	191	05.09	PR: 1KD				
	1.4 TSI	90	10.07	PR: 1KJ,1KZ	G1020682	23914 17,1 /WD/Acc/S	LUC
	1.4 TSI	92	11.13	PR: 1KJ,1KZ			
	1.4 TSI	110	11.13	PR: 1KJ,1KZ			
	1.4 TSI	118	05.08	PR: 1KJ,1KZ			
	1.6 FSI	85	05.06	PR: 1KJ,1KZ			
	2.0 FSI	110	05.06	PR: 1KJ,1KZ			
	2.0 TDI	100	11.10	PR: 1KJ,1KZ			
	2.0 TDI	103	05.06	PR: 1KJ,1KZ			
	2.0 TDI 16V	103	05.08	PR: 1KJ,1KZ			
	2.0 TFSI	147	05.06	PR: 1KJ,1KZ			
	2.0 TFSI	162	11.13	PR: 1KJ,1KZ			
2.0 TSI	155	11.09	PR: 1KJ,1KZ				
3.2 V6	184	05.06	PR: 1KJ,1KZ				
3.6 V6	191	05.09	PR: 1KJ,1KZ				
	1.4 TSI	90	10.07	PR: 2EA	G1020682	23914 17,1 /WD/Acc/S	LUC
	1.4 TSI	92	11.13	PR: 2EA			
	1.4 TSI	110	11.13	PR: 2EA			



VOLKSWAGEN EOS (06-)									
	1.4 TSI	118		05.08	PR: 2EA	G1020682		23914 17,1 /WD/Acc/S	LUC
	1.6 FSI	85		05.06	PR: 2EA				
	2.0 FSI	110		05.06	PR: 2EA				
	2.0 TDI	100		11.10	PR: 2EA				
	2.0 TDI	103		05.06	PR: 2EA				
	2.0 TDI 16V	103		05.08	PR: 2EA				
	2.0 TFSI	147		05.06	PR: 2EA				
	2.0 TFSI	162		11.13	PR: 2EA				
	2.0 TSI	155		11.09	PR: 2EA				
	3.2 V6	184		05.06	PR: 2EA				
	3.6 V6	191		05.09	PR: 2EA				
	1.4 TSI	90		10.07	PR: 1KD	G2110277		253 10,0 8,0 +S +C	
	1.4 TSI	92		11.13	PR: 1KD				
	1.4 TSI	110		11.13	PR: 1KD				
	1.4 TSI	118		05.08	PR: 1KD				
	1.6 FSI	85		05.06	PR: 1KD				
	2.0 FSI	110		05.06	PR: 1KD				
	2.0 TDI	100		11.10	PR: 1KD				
	2.0 TDI	103		05.06	PR: 1KD				
	2.0 TDI 16V	103		05.08	PR: 1KD				
	2.0 TFSI	147		05.06	PR: 1KD				
	2.0 TFSI	162		11.13	PR: 1KD				
	2.0 TSI	155		11.09	PR: 1KD				
	3.2 V6	184		05.06	PR: 1KD				
	3.6 V6	191		05.09	PR: 1KD				
	1.4 TSI	90		10.07	PR: 1KS	G2110356		272 9,7 8,0 +S +C	
	1.4 TSI	92		11.13	PR: 1KS				
	1.4 TSI	110		11.13	PR: 1KS				
	1.4 TSI	118		05.08	PR: 1KS				
	1.6 FSI	85		05.06	PR: 1KS				
	2.0 FSI	110		05.06	PR: 1KS				
	2.0 TDI	100		11.10	PR: 1KS				
	2.0 TDI	103		05.06	PR: 1KS				
	2.0 TDI 16V	103		05.08	PR: 1KS				
	2.0 TFSI	147		05.06	PR: 1KS				
	2.0 TFSI	162		11.13	PR: 1KS				
	2.0 TSI	155		11.09	PR: 1KS				
	3.2 V6	184		05.06	PR: 1KS				
	3.6 V6	191		05.09	PR: 1KS				
	1.4 TSI	90		10.07	PR: 1KJ,1KZ	G2112169		282 12,0 10,0 +S +C	
	1.4 TSI	92		11.13	PR: 1KJ,1KZ				
	1.4 TSI	110		11.13	PR: 1KJ,1KZ				
	1.4 TSI	118		05.08	PR: 1KJ,1KZ				
	1.6 FSI	85		05.06	PR: 1KJ,1KZ				
	2.0 FSI	110		05.06	PR: 1KJ,1KZ				
	2.0 TDI	100		11.10	PR: 1KJ,1KZ				
	2.0 TDI	103		05.06	PR: 1KJ,1KZ				
	2.0 TDI 16V	103		05.08	PR: 1KJ,1KZ				
	2.0 TFSI	147		05.06	PR: 1KJ,1KZ				
	2.0 TFSI	162		11.13	PR: 1KJ,1KZ				
	2.0 TSI	155		11.09	PR: 1KJ,1KZ				
	3.2 V6	184		05.06	PR: 1KJ,1KZ				
	3.6 V6	191		05.09	PR: 1KJ,1KZ				
VOLKSWAGEN FOX (05-)									
	1.0			10.03	PR: 1ZN	G1020408		21866 17,2 +	VW
	1.2			04.05	PR: 1ZN				
	1.4	55		04.05	PR: 1ZN				
	1.4 TDI	51		04.05	PR: 1ZN				
	1.6			10.03	PR: 1ZN				
	1.9 D	47		12.07	PR: 1ZN				
	1.0			10.03	PR: 1ZF	G1020331		23130 19,7 +	VW
	1.2			04.05	PR: 1ZF				
	1.4	55		04.05	PR: 1ZF				
	1.4 TDI	51		04.05	PR: 1ZF				
	1.6			10.03	PR: 1ZF				
	1.9 D	47		12.07	PR: 1ZF				
	1.0			10.03	PR: 1ZN	G2118137		239 18,0 16,0 V L +S +C	
	1.2			04.05	PR: 1ZN				
	1.4	55		04.05	PR: 1ZN				
	1.4 TDI	51		04.05	PR: 1ZN				
	1.6			10.03	PR: 1ZN				
	1.9 D	47		12.07	PR: 1ZN				
	1.0			10.03	PR: 1ZF	G2122151		256 22,0 19,0 V L +S +C	
	1.2			04.05	PR: 1ZF				
	1.4	55		04.05	PR: 1ZF				
	1.4 TDI	51		04.05	PR: 1ZF				
	1.6			10.03	PR: 1ZF				
	1.9 D	47		12.07	PR: 1ZF				
VOLKSWAGEN GOLF II (84-93)									
	1.0		19-E-855000	08.83		G1020025		20889 17,3 /Acc	VW
	1.0			08.86	10.91 - ABS				
	1.0			08.83	07.86				
	1.3		19-E-855000	08.83					
	1.3			08.86	12.93 - ABS				
	1.3			08.83	07.86				



**VOLKSWAGEN GOLF II (84-93)**

	1.6 1.6 D 1.6 D 1.6 D	53	19-E-855000	08.83 08.83 08.86 08.83	07.86 08.83 07.92 07.86	- (⊖) + manual transmission 1) - (⊖)	G1020025		20889 17,3 /Acc	VW
	1.0 1.0 1.3 1.3 1.6 1.6 1.6 D 1.6 D 1.6 D 1.6 TD 1.8 1.8 1.8 Syncro	19-E-855001 19-E-855001 55 19-E-855001 62 66		08.89 08.89 08.86 08.83 08.86 08.83 08.83 08.83 01.84 01.84	10.91 07.86 12.93 07.86 12.93 07.86 07.92 07.86 12.93 07.92 07.92	+ ABS + ABS + autom.transmission 2) + (⊕) - (⊖) - ABS/ - GT - ABS/ - GT	G1020009		20887 19,7 +/-Acc	VW
	1.8 1.8 1.8 1.8 GT 1.8 GT Special 1.8 GTI 1.8 GTI 16V 1.8 GTI 16V	62 66 77	19-JH560001 19-JH560001	08.88 08.85 08.85 01.84	07.92 07.92 07.92 07.92	+ ABS + ABS + (⊕)	G1020010		20887 15,3 +/-Acc	VW
	1.8 GTI 16V 1.8 GTI 16V	1G-KB075001 1G-KW240001	1G-KW240000 1G-KB075000	02.86 02.86	07.92 07.92		G1020273		20168 16,0 /S	LUC
	1.8 G60 1.8 Rallye 1.8 Syncro G60			04.90 04.89 04.89	07.92 07.92 07.92		G1020274		20168 19,3 /S	LUC
	1.0 1.0 1.0 1.3 1.3 1.3 1.6 1.6 D 1.6 D 1.6 D	53	19-E-855000 19-E-855000 19-E-855000	08.83 08.86 08.83 08.83 08.86 08.83 08.83 08.83	07.86 10.91 07.86 12.93 07.86 07.86 07.92 07.86	- ABS - ABS - ABS - (⊖) + manual transmission 1) - (⊖)	G2110151		239 10,0 8,0 +S +C	
	1.0 1.0 1.3 1.3 1.6 1.6 1.6 D 1.6 D 1.6 D 1.6 TD 1.8 1.8 1.8 Syncro	19-E-855001 19-E-855001 55 19-E-855001 62 66		08.89 08.89 08.86 08.83 08.86 08.83 08.83 08.83 01.84 01.84	10.91 07.86 12.93 07.86 12.93 07.86 07.92 07.86 12.93 07.92 07.92	+ ABS + ABS + autom.transmission 2) - (⊖) + (⊕) - ABS/ - GT - ABS/ - GT	G2112106		239 12,0 10,0 +S +C	
	1.8 1.8 1.8 1.8 GT 1.8 GT Special 1.8 GTI 1.8 GTI 16V 1.8 GTI 16V	62 66 77	19-JH560001 19-JH560001	01.84 07.92 07.92 08.88 08.85 08.85 01.84	07.92 07.92 07.92 07.92 07.92 07.92	+ ABS + ABS + (⊕)	G2120123		239 20,0 18,0 V L +S +C	
	1.8 GTI 16V 1.8 GTI 16V	1G-KB075001 1G-KW240001	1G-KB075000 1G-KW240000	07.92 07.92	07.92 07.92		G2120128		256 20,0 18,0 V L +S +C	
	1.8 1.8 1.8 G60 1.8 GT 1.8 GT Special 1.8 GTI 1.8 GTI 16V 1.8 Rallye 1.8 Syncro G60	62 66	19-JH480001 19-JH480001	04.90 08.85 08.85 01.84 02.86 04.89 04.89	07.92 07.92 07.92 07.92 07.92 07.92 07.92	+ ABS + ABS	G1020201		20961 15,2 /WD/Acc/S	LUC
	1.8 1.8 1.8 G60 1.8 GT 1.8 GT Special 1.8 GTI 1.8 GTI 16V	62 66	19-JH480001 19-JH480001	04.90 08.85 08.85 01.84 02.86	07.92 07.92 07.92 07.92 07.92	+ ABS + ABS	G2110111	without sensor ring 3)	226 10,0 8,0 +C	
	1.8 Rallye 1.8 Syncro G60			04.89 04.89	07.92 07.92		G2110151		239 10,0 8,0 +S +C	

1) + scatola cambio velocità / + transmission mécanique / + cambio de velocidad / + Schaltgetriebe  
 2) + scatola cambio automatico / + transmission automatique / + cambio automático / + Automatikgetriebe  
 3) senza sensori / sans secours ABS / sin anillo sensor ABS / ohne Sensorring



**VOLKSWAGEN GOLF III (92-97)**

	1.4 1.6 1.8 CL/GL 1.8 CL/GL 1.8 Syncro 1.9 D 1.9 D Ecomatic 1.9 SDI 1.9 TD	55        55		1H-T-028354 1H-T-028354 1H-T-028354 1H-S-246940 1H-S-089450 1H-T-028354 1H-S-246940 1H-T-028354 1H-T-028354	11.91 09.92 11.91 11.91 01.93 11.91 08.93 07.95 11.91					G1020009		20887 19,7 +/Acc	VW
	1.4 1.6 1.8 CL/GL 1.9 D 1.9 SDI 1.9 TD	55 55 55 55 55	1H-T-028355 1H-T-028355 1H-T-028355 1H-T-028355 1H-T-028355 1H-T-028355		08.97 08.97 08.97 08.97 08.97 08.97	- ABS - ABS - ABS/ + manual transmission <sup>3)</sup> - ABS - ABS - ABS				G1020355		21866 19,7 +	VW
	1.6 CL/GL 1.8 CL/GL 1.8 Syncro 1.9 TDI 1.9 TDI 1.9 TDI Syncro 2.0 GTI 2.0 GTI 16V	74 74 66 81 66 85	1H-S-246941 1H-S-089451 1H-S-560001 1H-S-560001	07.94 10.93 02.96 03.95	08.97 04.96 04.96 04.96 04.96	- ABS - ABS - ABS + red caliper <sup>4)</sup> - ABS				G1020274		20168 19,3 /S	LUC
	1.9 TDI 2.0 GTI 2.0 GTI 16V 2.8 VR6 2.9 VR6 Syncro	81 85 85	1H-S-400001	05.96 05.96 05.96	08.97 08.97 08.97 08.97 08.97	+ red caliper <sup>4)</sup> - ABS - ABS - ABS - ABS				G1020379		21911 20,3 +	ATE
	1.4 1.6 1.6 GT 1.8 1.8 GT 1.8 Syncro 1.9 D 1.9 D Ecomatic 1.9 SDI 1.9 TD 1.9 TDI 1.9 TDI 1.9 TDI 1.9 TDI Syncro 2.0 2.0 Syncro	55 74 66 81 66 81 66	1H-S-246941	05.96 05.96 07.94 05.96 11.91 01.93 05.96 05.96 05.96 05.96 05.96 02.96 05.96 11.91 07.95	09.96 09.96 08.97 08.97 08.97 08.97 08.97 09.96 09.96 08.97 08.97 08.97 08.97 08.97 08.97	+ ABS + ABS  + ABS  + ABS + ABS + ABS + ABS + ABS + ABS + ABS + ABS + ABS + ABS + ABS + ABS				G1020444		21945 16,0 /S	LUC
	1.4 1.6 1.9 D 1.9 SDI 1.9 TD	55 55 55		10.96 10.96 10.96 10.96	08.97 08.97 08.97 08.97 08.97	+ ABS + ABS + ABS + ABS + ABS				G1020390		21866 15,3 +	VW
	1.4 1.6 1.8 1.8 1.8 Syncro 1.9 D 1.9 D Ecomatic 1.9 SDI 1.9 TD	55	1H-S-246940 1H-S-089450 1H-S-246940	11.91 09.92 11.91 11.91 01.93 11.91 11.91 07.95 11.91	08.97 08.97 08.97 08.97 08.97 08.97 08.97 08.97 08.97	- ABS - ABS - ABS/ - GT/ + autom.transm. <sup>6)</sup> - ABS/ - GT/ + manual transm. <sup>7)</sup> - ABS - ABS - ABS - ABS - ABS				G2112106		239 12,0 10,0 +S +C	
	1.6 CL/GL 1.8 1.8 Syncro 1.9 TDI 1.9 TDI Syncro	74 66 66	1H-S-246941 1H-S-089451	07.94 10.93 03.95	08.97 08.97 04.96 04.96	- ABS - ABS/ + autom.transmission <sup>8)</sup> - ABS				G2113178		256 12,9 11,0 +S +C	
	1.4 1.6 1.6 GT 1.8 1.8 GT 1.8 Syncro 1.9 D 1.9 D Ecomatic 1.9 SDI 1.9 TD 1.9 TDI 1.9 TDI 1.9 TDI 1.9 TDI Syncro 2.0 2.0 Syncro	55 74 66 81 66	1H-S-246941	05.96 05.96 07.94 05.96 11.91 01.93 05.96 05.96 05.96 05.96 05.96 02.96 05.96 11.91 07.95	09.96 09.96 08.97 08.97 08.97 08.97 08.97 09.96 09.96 08.97 08.97 08.97 08.97 08.97 08.97	+ ABS + ABS + ABS + ABS + ABS + ABS + ABS + ABS + ABS + ABS + ABS + ABS + ABS + ABS + ABS				G2120128	for 4 bore wheel rim <sup>9)</sup>	256 20,0 18,0 V L +S +C	
	1.4 1.6 1.9 D 1.9 SDI 1.9 TD	55 55		10.96 10.96 10.96 10.96	08.97 08.97 08.97 08.97 08.97	+ ABS + ABS + ABS + ABS + ABS				G2120123		239 20,0 18,0 V L +S +C	

1) + scatola cambio velocità / + transmission mécanique / + cambio de velocidad / + Schaltgetriebe  
 2) + scatola cambio automatico / + transmission automatique / + cambio automático / + Automatikgetriebe  
 3) - ABS/+ scatola camb.velocità / - ABS/ + transmission mécanique / - ABS/ + cambio de velocidad / - ABS/ + Schaltgetriebe  
 4) + pinza rossa / + étrier rouge / + pinza roja / + roter Sattel  
 5) - pinza rossa / - étrier rouge / - pinza roja / - roter Sattel  
 6) - ABS/ - GT/+ scatola camb.autom. / - ABS/ - GT/ + transmiss. automatique / - ABS/ - GT/ + cambio automático / - ABS/ - GT/ + Automatikgetriebe

7) - ABS/ - GT/+ scatola camb.velocità / - ABS/ - GT/ + transmiss. mécanique / - ABS/ - GT/ + cambio de velocidad / - ABS/ - GT/+ Schaltgetriebe  
 8) - ABS/ + scatola cambio autom. / - ABS/ + transmission automatique / - ABS/ + cambio automático / - ABS/ + Automatikgetriebe  
 9) per cerchione a 4 fori / pour jante à 4 trous / para Llantas de 4 taladros / für 4-Loch-Felge



VOLKSWAGEN GOLF III (92-97)											
	1.8 GT			11.91	08.97	G1020201			20961 15,2 /WD/Acc/S	LUC	
	2.0 GL			11.91	08.97						
	2.0 GTI	85		1H-P-240000	11.91						
	2.0 GTI 16V			1H-P-240000	11.91						
	2.8 VR6			1H-P-240000	01.92						
1.6 GT	74			07.94	08.97	G1020345		20961 17,0 /WD/Acc/S	LUC		
1.9 TDI	81			02.96	08.97						
2.0 GTI	85	1H-P-240001			08.97						
2.0 GTI 16V		1H-P-240001			08.97						
2.8 VR6		1H-P-240001			08.97						
2.9 VR6 Syncro				10.94	08.97						
	1.6 GT	74			07.94	G2110111		for 4-hole rim/-sensor ring <sup>1)</sup>	226 10,0 8,0 +C		
	1.8 GT				11.91						08.97
	1.9 TDI	81			02.96						08.97
	2.0 GL	85			11.91						08.97

















VOLKSWAGEN GOLF III Variant (93-99)																
	1.4			1H-TB015953	07.93	G1020009			20887 19,7 +/Acc	VW						
	1.8 Syncro			1H-SW369000	07.94											
	1.4				05.96	G1020355			21866 19,7 +	VW						
	1.4		1H-TB015954		04.96						- ABS					
	1.6	55			05.96	G1020274			20168 19,3 /S	LUC						
	1.6	55			09.92						04.96	- ABS				
	1.6	74			07.94						04.96					
	1.8				05.96						04.99	- ABS				
	1.8				07.93						04.96					
	1.8 Syncro		1H-SW369001	1H-TD365209												
	1.9 D				05.96						04.99	- ABS				
	1.9 D				07.93						04.96					
	1.9 SDI				05.96						04.99	- ABS				
	1.9 SDI				07.95						04.96					
	1.9 TD				05.96						04.99	- ABS				
	1.9 TD	55			07.93						04.96					
	1.9 TDI	66			05.96						04.99	- ABS				
	1.9 TDI	66			07.93						04.96					
	1.4				05.96						09.96	+ ABS	G1020444		21945 16,0 /S	LUC
	1.6	55			05.96						09.96	+ ABS				
	1.6	74			05.96						04.99					
	1.8				05.96						04.99	+ ABS				
	1.8 Syncro		1H-TD365210								04.99					
	1.9 D				05.96						09.96	+ ABS				
1.9 SDI				05.96	09.96	+ ABS										
1.9 TD				05.96	09.96	+ ABS										
1.9 TDI	66			05.96	04.99	+ ABS										
1.9 TDI	81			02.96	04.99											
1.9 TDI Syncro	66			07.95	04.99											
2.0				07.93	04.99											
2.0 Syncro				07.95	04.99											
1.4				10.96	04.99	+ ABS	G1020390		21866 15,3 +	VW						
1.6	55			10.96	04.99	+ ABS										
1.9 D				10.96	04.99	+ ABS										
1.9 SDI				10.96	04.99	+ ABS										
1.9 TD				10.96	04.99	+ ABS										
2.9 VR6				07.95	04.99		G1020379		21911 20,3 +	ATE						
	1.4				05.96	04.99	- ABS	G2112106		239 12,0 10,0 +S +C						
	1.4				07.93	04.96										
	1.8 Syncro			1H-SW369000	07.94											
	1.6	55			05.96	04.99	- ABS	G2113178		256 12,9 11,0 +S +C						
	1.6	55			07.94	04.96										
	1.6	74			07.94	04.96										
	1.8				05.96	04.99	- ABS									
	1.8				07.93	04.96										
	1.8 Syncro		1H-SW369001	1H-TD365209												
	1.9 D				05.96	04.99	- ABS									
	1.9 D				07.93	04.96										
	1.9 SDI				05.96	04.99	- ABS									
	1.9 SDI				07.95	04.96										
	1.9 TD	55			05.96	04.99	- ABS									
	1.9 TD	55			07.93	04.96										
	1.9 TDI	66			05.96	04.99	- ABS									
	1.9 TDI	66			07.93	04.96										
	1.4				05.96	09.96	+ ABS					G2120128		256 20,0 18,0 V L +S +C		
	1.6	55			05.96	09.96	+ ABS									
	1.6	74			05.96	04.99										
1.8				05.96	04.99	+ ABS										
1.8 Syncro		1H-TD365210			04.99											
1.9 D				05.96	09.96	+ ABS										
1.9 SDI				05.96	09.96	+ ABS										
1.9 TD	55			05.96	09.96	+ ABS										
1.9 TDI	66			05.96	04.99	+ ABS										
1.9 TDI	81			02.96	04.99											
1.9 TDI Syncro	66			07.95	04.99											
2.0				07.93	04.99											
2.0 Syncro				07.95	04.99											
1.4				10.96	04.99	+ ABS	G2120123		239 20,0 18,0 V L +S +C							
1.6	55			10.96	04.99	+ ABS										

<sup>1)</sup> per cerch.4 fori/-sensore ruota / pour jante 4 trous/-roue codeuse / para llanta cuatro agujeros/-anillo sensor / für 4-Loch-Felge/- Sensorring

<sup>2)</sup> - pinza rossa / - étrier rouge / - pinza roja / - roter Sattel





									
<b>VOLKSWAGEN GOLF III Variant (93-99)</b>									
	1.9 D 1.9 SDI 1.9 TD	55	1E-T-030000	10.96 10.96 10.96	04.99 + ABS 04.99 + ABS 04.99 + ABS	G2120123		239 20,0 VL +S +C	
	2.9 VR6			07.95	04.99	G1020345		20961 17,0 /WD/Acc/S LUC	
<b>VOLKSWAGEN GOLF III Convertible (94-02)</b>									
	1.6 1.8 1.8 1.9 TDI	55 66 66 66	1E-T-030000 1E-T-030000 1E-T-030000 1E-T-030000	10.94 09.93 09.93 08.95		G1020274		20168 19,3 /S LUC	
	1.6 1.8 1.8 1.9 TDI 1.9 TDI 2.0	1E-V-000001 55 1E-V-000001 66 1E-V-000001 66 1E-V-000001 81 85			02.02 02.02 02.02 02.02 09.96 09.93	G1020444		21945 16,0 /S LUC	
	1.6 1.8 1.8 1.9 TDI	55 66 66 66	1E-T-030000 1E-T-030000 1E-T-030000 1E-T-030000	10.94 09.93 09.93 08.95		G2113178		256 12,9 11,0 +S +C	
	1.6 1.8 1.8 1.9 TDI 1.9 TDI 2.0	1E-V-000001 55 1E-V-000001 66 1E-V-000001 66 1E-V-000001 81 85			02.02 02.02 02.02 02.02 09.96 09.93	G2120128		256 20,0 18,0 VL +S +C	
	1.6 1.8 1.9 TDI 1.9 TDI 2.0	66 81 85	1E-X-016000 1E-X-016000 1E-X-016000 1E-X-016000 1E-X-016000	04.98 04.98 04.98 09.96 04.98		G1020201		20961 15,2 /WD/Acc/S LUC	
	1.6 1.8 1.9 TDI 1.9 TDI 2.0	1E-X-016001 1E-X-016001 66 1E-X-016001 81 1E-X-016001 85 1E-X-016001	1E-2-015 000		02.02 02.02 02.02 + ABS 02.02 + ABS	G1020345		20961 17,0 /WD/Acc/S LUC	
	2.0	85	1E-2-800 001		02.02	G1020755		20961 17,1 /Acc/S LUC	
	1.9 TDI 1.9 TDI	66 81	1E-X-016001 1E-X-016001		02.02 - ABS 02.02 - ABS	G1020201		20961 15,2 /WD/Acc/S LUC	
	1.6 1.8 1.9 TDI 1.9 TDI 2.0	66 81 85		04.98 04.98 04.98 09.96 04.98	02.02 02.02 02.02 02.02 02.02	G2110111	without sensor ring <sup>1)</sup>	226 10,0 8,0 +C	
<b>VOLKSWAGEN GOLF IV (98-05)</b>									
	1.4 1.6 1.8 1.9 SDI 1.9 TDI 1.9 TDI 1.9 TDI	50 66 74 81 85	1J-X-800000 1J-X-800000 1J-X-800000 1J-X-800000 1J-X-800000 1J-X-800000 1J-X-800000	10.97 10.97 10.97 10.97 09.00 10.97 05.99	PR: 1LQ,1LR,1ZF PR: 1LQ,1LR,1ZF PR: 1LQ,1LR,1ZF PR: 1LQ,1LR,1ZF PR: 1LQ,1LR,1ZF PR: 1LQ,1LR,1ZF PR: 1LQ,1LR,1ZF	G1020331		23130 19,7 + VW	
	1.4 1.6 1.6 FSI 1.8 1.8 4motion 1.9 SDI 1.9 TDI 1.9 TDI 1.9 TDI 1.9 TDI 1.9 TDI 4motion 1.9 TDI 4motion 1.9 TDI 4motion 2.0 2.0 4motion	1J-Y-000001 1J-Y-000001 1J-Y-000001 92 50 66 74 81 85 66 74 85 85 85			10.03 10.03 10.03 10.03 10.03 10.03 06.01 06.05 10.03 06.01 07.98 06.01 09.00 11.99 06.01 08.98 04.00	PR: 1LS,1LQ,1ZF,1ZM PR: 1LS,1LQ,1ZF,1ZM PR: 1LS,1LQ,1ZF,1ZM PR: 1LS,1LQ,1ZF,1ZM PR: 1LS,1LQ,1ZF,1ZM PR: 1LS,1LQ,1ZF,1ZM PR: 1LS,1LQ,1ZF,1ZM PR: 1LS,1LQ,1ZF,1ZM PR: 1LS,1LQ,1ZF,1ZM PR: 1LS,1LQ,1ZF,1ZM PR: 1LS,1LQ,1ZF,1ZM PR: 1LS,1LQ,1ZF,1ZM PR: 1LS,1LQ,1ZF,1ZM PR: 1LS,1LQ,1ZF,1ZM PR: 1LS,1LQ,1ZF,1ZM PR: 1LS,1LQ,1ZF,1ZM	G1020463		23131 19,7 +/WI VW
	1.8 T GTI 2.3 V5 2.3 V5 4motion 2.8 V6 4motion	132	1J-X-800000 1J-X-800000 1J-X-800000	10.97 10.97 11.98 01.99	10.03 PR: 1LE,1LN,1ZE,1ZH PR: 1LE,1LN,1ZE,1ZH PR: 1LE,1LN,1ZE,1ZH	G1020379		21911 20,3 + ATE	
	1.8 1.8 4motion 1.9 TDI 1.9 TDI 1.9 TDI 4motion 1.9 TDI 4motion 2.3 V5 2.3 V5 4motion 2.8 V6 4motion	92 96 110 96 110 1J-Y-000001 1J-Y-000001 1J-Y-000001		10.97 07.98 04.01 09.00 04.01 09.00	10.03 PR: 1LJ,1ZE,1ZQ PR: 1LJ,1ZE,1ZQ PR: 1LJ,1ZE,1ZQ PR: 1LJ,1ZE,1ZQ PR: 1LJ,1ZE,1ZQ PR: 1LJ,1ZE,1ZQ PR: 1LJ,1ZE,1ZQ PR: 1LJ,1ZE,1ZQ PR: 1LJ,1ZE,1ZQ	G1020512		23392 20,3 +/WI ATE	
	3.2 R32 4motion			06.02	10.03 PR: 1ZT	G1020683		21484 20,5 +/WD ATE	

<sup>1)</sup> senza sensori / sans secours ABS / sin anillo sensor ABS / ohne Sensorring



**VOLKSWAGEN GOLF IV (98-05)**

	1.4		10.97	10.03	PR: 1LQ,1ZF	G2122151	256 22,0 19,0 V L +S +C	
	1.6		10.97	10.03	PR: 1LQ,1ZF			
	1.6 FSI		01.02	10.03	PR: 1LQ,1ZF			
	1.8		10.97	10.03	PR: 1LQ,1ZF			
	1.8 4motion	92	07.98	10.03	PR: 1LQ,1ZF			
	1.9 SDI	50	10.97	10.03	PR: 1LQ,1ZF			
	1.9 TDI	66	10.97	06.01	PR: 1LQ,1ZF			
	1.9 TDI	74	09.00	06.05	PR: 1LQ,1ZF			
	1.9 TDI	81	10.97	10.03	PR: 1LQ,1ZF			
	1.9 TDI	85	05.99	06.01	PR: 1LQ,1ZF			
	1.9 TDI	96	04.01	10.03	PR: 1LQ,1ZF			
	1.9 TDI	110	09.00	10.03	PR: 1LQ,1ZF			
	1.9 TDI 4motion	66	07.98	06.01	PR: 1LQ,1ZF			
	1.9 TDI 4motion	74	09.00	06.05	PR: 1LQ,1ZF			
	1.9 TDI 4motion	85	11.99	06.01	PR: 1LQ,1ZF			
	1.9 TDI 4motion	96	04.01	10.03	PR: 1LQ,1ZF			
	1.9 TDI 4motion	110	09.00	10.03	PR: 1LQ,1ZF			
	2.0	85	08.98	10.03	PR: 1LQ,1ZF			
	2.0 4motion	85	04.00	10.03	PR: 1LQ,1ZF			
	2.3 V5		10.97	10.03	PR: 1LQ,1ZF			
2.3 V5 4motion		11.98	10.03	PR: 1LQ,1ZF				
	1.4		10.97	10.03	PR: 1LR,1LS,1ZM	G2122150	280 22,0 19,0 V L +S +C	
	1.6		10.97	10.03	PR: 1LR,1LS,1ZM			
	1.6 FSI		01.02	10.03	PR: 1LR,1LS,1ZM			
	1.8		10.97	10.03	PR: 1LR,1LS,1ZM			
	1.8 4motion	92	07.98	10.03	PR: 1LR,1LS,1ZM			
	1.9 SDI	50	10.97	10.03	PR: 1LR,1LS,1ZM			
	1.9 TDI	66	10.97	06.01	PR: 1LR,1LS,1ZM			
	1.9 TDI	74	09.00	06.05	PR: 1LR,1LS,1ZM			
	1.9 TDI	81	10.97	10.03	PR: 1LR,1LS,1ZM			
	1.9 TDI	85	05.99	06.01	PR: 1LR,1LS,1ZM			
	1.9 TDI	96	04.01	10.03	PR: 1LR,1LS,1ZM			
	1.9 TDI	110	09.00	10.03	PR: 1LR,1LS,1ZM			
	1.9 TDI 4motion	66	07.98	06.01	PR: 1LR,1LS,1ZM			
	1.9 TDI 4motion	74	09.00	06.05	PR: 1LR,1LS,1ZM			
	1.9 TDI 4motion	85	11.99	06.01	PR: 1LR,1LS,1ZM			
	1.9 TDI 4motion	96	04.01	10.03	PR: 1LR,1LS,1ZM			
	1.9 TDI 4motion	110	09.00	10.03	PR: 1LR,1LS,1ZM			
	2.0	85	08.98	10.03	PR: 1LR,1LS,1ZM			
	2.0 4motion	85	04.00	10.03	PR: 1LR,1LS,1ZM			
	2.3 V5		10.97	10.03	PR: 1LR,1LS,1ZM			
2.3 V5 4motion		11.98	10.03	PR: 1LR,1LS,1ZM				
	1.4		10.97	10.03	PR: 1LE,1LN,1ZE,1ZH	G2125113	288 25,0 22,0 V L +S +C	
	1.6		10.97	10.03	PR: 1LE,1LN,1ZE,1ZH			
	1.6 FSI		01.02	10.03	PR: 1LE,1LN,1ZE,1ZH			
	1.8		10.97	10.03	PR: 1LE,1LN,1ZE,1ZH			
	1.8 4motion	92	10.97	06.01	PR: 1LE,1LN,1ZE,1ZH			
	1.9 SDI	50	10.97	10.03	PR: 1LE,1LN,1ZE,1ZH			
	1.9 TDI	66	10.97	06.01	PR: 1LE,1LN,1ZE,1ZH			
	1.9 TDI	74	09.00	06.05	PR: 1LE,1LN,1ZE,1ZH			
	1.9 TDI	81	10.97	10.03	PR: 1LE,1LN,1ZE,1ZH			
	1.9 TDI	85	05.99	06.01	PR: 1LE,1LN,1ZE,1ZH			
	1.9 TDI	96	04.01	10.03	PR: 1LE,1LN,1ZE,1ZH			
	1.9 TDI	110	09.00	10.03	PR: 1LE,1LN,1ZE,1ZH			
	1.9 TDI 4motion	66	07.98	06.01	PR: 1LE,1LN,1ZE,1ZH			
	1.9 TDI 4motion	74	09.00	06.05	PR: 1LE,1LN,1ZE,1ZH			
	1.9 TDI 4motion	85	11.99	06.01	PR: 1LE,1LN,1ZE,1ZH			
	1.9 TDI 4motion	96	04.01	10.03	PR: 1LE,1LN,1ZE,1ZH			
	1.9 TDI 4motion	110	09.00	10.03	PR: 1LE,1LN,1ZE,1ZH			
	2.0	85	08.98	10.03	PR: 1LE,1LN,1ZE,1ZH			
	2.0 4motion	85	04.00	10.03	PR: 1LE,1LN,1ZE,1ZH			
	2.3 V5		10.97	10.03	PR: 1LE,1LN,1ZE,1ZH			
2.3 V5 4motion		11.98	10.03	PR: 1LE,1LN,1ZE,1ZH				
	1.8 T GTI	132	10.97	10.03		G2125123	310 25,0 22,0 V L +C	
	2.3 V5		10.97	10.03	PR: 1LJ,1ZQ			
	2.3 V5 4motion		11.98	10.03	PR: 1LJ,1ZQ			
	2.8 V6 4motion		01.99	10.03	PR: 1LJ,1ZQ			
	1.4		10.97	10.03	PR: 1KK,1KS,1KV	G1020755	20961 17,1 /Acc/S	LUC
	1.6		10.97	10.03	PR: 1KK,1KS,1KV			
	1.6 FSI		01.02	10.03	PR: 1KK,1KS,1KV			
	1.8		10.97	10.03	PR: 1KK,1KS,1KV			
	1.8 4motion	92	07.98	10.03	PR: 1KE			
	1.9 SDI	50	10.97	10.03	PR: 1KK,1KS,1KV			
	1.9 TDI	66	10.97	06.01	PR: 1KK,1KS,1KV			
	1.9 TDI	74	09.00	06.05	PR: 1KK,1KS,1KV			
	1.9 TDI	81	10.97	10.03	PR: 1KK,1KS,1KV			
	1.9 TDI	85	05.99	06.01	PR: 1KK,1KS,1KV			
	1.9 TDI	96	04.01	10.03	PR: 1KK,1KS,1KV			
	1.9 TDI	110	09.00	10.03	PR: 1KK,1KS,1KV			
	1.9 TDI 4motion	66	07.98	06.01	PR: 1KE			
	1.9 TDI 4motion	74	09.00	06.05	PR: 1KE			
	1.9 TDI 4motion	85	11.99	06.01	PR: 1KE			
	1.9 TDI 4motion	96	04.01	10.03	PR: 1KE			
	1.9 TDI 4motion	110	09.00	10.03	PR: 1KE			
2.0	85	08.98	10.03	PR: 1KK,1KS,1KV				
2.0 4motion	85	04.00	10.03	PR: 1KE				
2.3 V5		10.97	10.03	PR: 1KK,1KS,1KV				





**VOLKSWAGEN GOLF IV (98-05)**

	2.3 V5 4motion			11.98	10.03	PR: 1KE	G1020755		20961 17,1 /Acc/S	LUC				
	2.8 V6 4motion			01.99	10.03	PR: 1KE								
	3.2 R32 4motion			06.02	10.03	PR: 1KE								
	1.4			10.97	10.03	PR: 1KY	G1020676		20961 15,8 /S	LUC				
	1.6			10.97	10.03	PR: 1KY								
	1.6 FSI			01.02	10.03	PR: 1KY								
	1.8			10.97	10.03	PR: 1KY								
	1.8 T GTI	132		10.97	10.03									
	1.9 SDI	50		10.97	10.03	PR: 1KY								
	1.9 TDI	66		10.97	06.01	PR: 1KY								
	1.9 TDI	74		09.00	06.05	PR: 1KY								
	1.9 TDI	81		10.97	10.03	PR: 1KY								
1.9 TDI	85		05.99	06.01	PR: 1KY									
1.9 TDI	96		04.01	10.03	PR: 1KY									
1.9 TDI	110		09.00	10.03	PR: 1KY									
2.0	85		08.98	10.03	PR: 1KY									
2.3 V5			10.97	10.03	PR: 1KY									
1.8 4motion	92		07.98	10.03	PR: 1KU,2EE,2EL	G1020492		23554 17,1 /WD/S	LUC					
1.9 TDI 4motion	66		07.98	06.01	PR: 1KU,2EE,2EL									
1.9 TDI 4motion	74		09.00	06.05	PR: 1KU,2EE,2EL									
1.9 TDI 4motion	85		11.99	06.01	PR: 1KU,2EE,2EL									
1.9 TDI 4motion	96		04.01	10.03	PR: 1KU,2EE,2EL									
1.9 TDI 4motion	110		09.00	10.03	PR: 1KU,2EE,2EL									
2.0 4motion	85		04.00	10.03	PR: 1KU,2EE,2EL									
2.3 V5 4motion			11.98	10.03	PR: 1KU,2EE,2EL									
2.8 V6 4motion			01.99	10.03	PR: 1KU,2EE,2EL									
3.2 R32 4motion			06.02	10.03	PR: 1KU,2EE,2EL									
	1.4			10.97	10.03					PR: 1KK,1KS,1KV	G2109123		230 9,0 7,0 +S +C	
	1.6			10.97	10.03					PR: 1KK,1KS,1KV				
	1.6 FSI			01.02	10.03	PR: 1KK,1KS,1KV								
	1.8			10.97	10.03	PR: 1KK,1KS,1KV								
	1.9 SDI	50		10.97	10.03	PR: 1KK,1KS,1KV								
	1.9 TDI	66		10.97	06.01	PR: 1KK,1KS,1KV								
	1.9 TDI	74		09.00	06.05	PR: 1KK,1KS,1KV								
	1.9 TDI	81		10.97	10.03	PR: 1KK,1KS,1KV								
	1.9 TDI	85		05.99	06.01	PR: 1KK,1KS,1KV								
	1.9 TDI	96		04.01	10.03	PR: 1KK,1KS,1KV								
	1.9 TDI	110		09.00	10.03	PR: 1KK,1KS,1KV								
	2.0	85		08.98	10.03	PR: 1KK,1KS,1KV								
2.3 V5			10.97	10.03	PR: 1KK,1KS,1KV									
1.8 4motion	92		07.98	10.03	PR: 1KE	G2109133		239 8,9 7,0 +S +C						
1.9 TDI 4motion	66		07.98	06.01	PR: 1KE									
1.9 TDI 4motion	74		09.00	06.05	PR: 1KE									
1.9 TDI 4motion	85		11.99	06.01	PR: 1KE									
1.9 TDI 4motion	96		04.01	10.03	PR: 1KE									
1.9 TDI 4motion	110		09.00	10.03	PR: 1KE									
2.0 4motion	85		04.00	10.03	PR: 1KE									
2.3 V5 4motion			11.98	10.03	PR: 1KE									
2.3 V5 4motion			11.98	10.03	PR: 1KU,2EE,2EL					G2122163		256 22,0 20,0 V L +C		
2.8 V6 4motion			01.99	10.03	PR: 1KU,2EE,2EL									
3.2 R32 4motion			06.02	10.03	PR: 1KU,2EE,2EL									
1.4			10.97	10.03	PR: 1KY					G2122163		256 22,0 20,0 V L +C		
1.6			10.97	10.03	PR: 1KY									
1.6 FSI			01.02	10.03	PR: 1KY									
1.8			10.97	10.03	PR: 1KY									
1.8 T GTI	132		10.97	10.03										
1.9 SDI	50		10.97	10.03	PR: 1KY									
1.9 TDI	66		10.97	06.01	PR: 1KY									
1.9 TDI	74		09.00	06.05	PR: 1KY									
1.9 TDI	81		10.97	10.03	PR: 1KY									
1.9 TDI	85		05.99	06.01	PR: 1KY									
1.9 TDI	96		04.01	10.03	PR: 1KY									
1.9 TDI	110		09.00	10.03	PR: 1KY									
2.0	85		08.98	10.03	PR: 1KY									
2.3 V5			10.97	10.03	PR: 1KY									

**VOLKSWAGEN GOLF IV Variant (99-06)**

	1.4			05.99	06.06	PR: 1LR,1LS,1ZF,1ZP,1ZM	G1020463		23131 19,7 +/WI	VW
	1.6			05.99	06.06	PR: 1LR,1LS,1ZF,1ZP,1ZM				
	1.6 FSI			01.02	06.06	PR: 1LR,1LS,1ZF,1ZP,1ZM				
	1.8 4motion	92		05.99	06.06	PR: 1LR,1LS,1ZF,1ZP,1ZM				
	1.9 SDI			05.99	06.06	PR: 1LR,1LS,1ZF,1ZP,1ZM				
	1.9 TDI	66		05.99	06.06	PR: 1LR,1LS,1ZF,1ZP,1ZM				
	1.9 TDI	74		09.00	06.06	PR: 1LR,1LS,1ZF,1ZP,1ZM				
	1.9 TDI	81		05.99	06.06	PR: 1LR,1LS,1ZF,1ZP,1ZM				
	1.9 TDI	85		05.99	06.06	PR: 1LR,1LS,1ZF,1ZP,1ZM				
	1.9 TDI 4motion	66		05.99	06.06	PR: 1LR,1LS,1ZF,1ZP,1ZM				
	1.9 TDI 4motion	74		09.00	06.06	PR: 1LR,1LS,1ZF,1ZP,1ZM				
	1.9 TDI 4motion	85		11.99	06.06	PR: 1LR,1LS,1ZF,1ZP,1ZM				
2.0	85		05.99	06.06	PR: 1LR,1LS,1ZF,1ZP,1ZM					
2.0 4motion			04.00	06.06	PR: 1LR,1LS,1ZF,1ZP,1ZM					
2.3 V5		1J-X-800000	05.99		PR: 1ZE	G1020379		21911 20,3 +	ATE	
2.3 V5 4motion		1J-X-800000	05.99		PR: 1ZE					
2.8 V6 4motion			05.99	06.06						
1.8 T	110		05.00	06.06	PR: 1ZD,1ZE	G1020512		23392 20,3 +/WI	ATE	
1.9 TDI	96		04.01	06.06	PR: 1ZD,1ZE					



**VOLKSWAGEN GOLF IV Variant (99-06)**

	1.9 TDI 4motion 2.3 V5 2.3 V5 4motion	1J-Y-000001 1J-Y-000001	04.01	06.06 PR: 1ZD,1ZE 06.06 PR: 1ZD,1ZE 06.06 PR: 1ZD,1ZE	G1020512		23392 20,3 +/WI	ATE
	1.4 1.6 1.6 FSI 1.8 4motion 1.9 SDI 1.9 TDI 1.9 TDI 1.9 TDI 1.9 TDI 1.9 TDI 4motion 1.9 TDI 4motion 1.9 TDI 4motion 2.0 2.0 4motion	92 66 74 81 85 66 74 85 85	05.99 05.99 01.02 05.99 05.99 05.99 09.00 05.99 05.99 05.99 09.00 11.99 05.99 04.00	06.06 PR: 1LR,1LS,1ZF,1ZP,1ZM 06.06 PR: 1LR,1LS,1ZF,1ZP,1ZM 06.06 PR: 1LR,1LS,1ZF,1ZP,1ZM 06.06 PR: 1LR,1LS,1ZF,1ZP,1ZM 06.06 PR: 1LR,1LS,1ZF,1ZP,1ZM 06.06 PR: 1LR,1LS,1ZF,1ZP,1ZM 06.06 PR: 1LR,1LS,1ZF,1ZP,1ZM 06.06 PR: 1LR,1LS,1ZF,1ZP,1ZM 06.06 PR: 1LR,1LS,1ZF,1ZP,1ZM 06.06 PR: 1LR,1LS,1ZF,1ZP,1ZM 06.06 PR: 1LR,1LS,1ZF,1ZP,1ZM 06.06 PR: 1LR,1LS,1ZF,1ZP,1ZM 06.06 PR: 1LR,1LS,1ZF,1ZP,1ZM 06.06 PR: 1LR,1LS,1ZF,1ZP,1ZM	G2122150		280 22,0 19,0 V L +S +C	
	1.8 T 1.9 TDI 1.9 TDI 4motion 2.3 V5 2.3 V5 4motion	110 96	05.00 04.01 04.01 05.99 05.99	06.06 PR: 1ZD,1ZE 06.06 PR: 1ZD,1ZE 06.06 PR: 1ZD,1ZE 06.06 PR: 1ZD,1ZE 06.06 PR: 1ZD,1ZE	G2125113		288 25,0 22,0 V L +S +C	
	1.4 1.6 1.6 FSI 1.8 4motion 1.8 T 1.9 SDI 1.9 TDI 1.9 TDI 1.9 TDI 1.9 TDI 1.9 TDI 1.9 TDI 1.9 TDI 4motion 1.9 TDI 4motion 1.9 TDI 4motion 1.9 TDI 4motion 2.0 2.0 4motion 2.3 V5 2.3 V5 4motion	92 110 66 74 81 85 96 66 74 85 85	05.99 05.99 01.02 05.99 05.00 05.99 05.99 09.00 05.99 05.99 04.01 04.01 05.99 09.00 11.99 05.99 04.00 05.99 05.99	06.06 PR: 1KE,1KP,1KT 06.06 PR: 1KE,1KP,1KT 06.06 PR: 1KE,1KP,1KT 06.06 PR: 1KE,1KP,1KT 06.06 PR: 1KE,1KP,1KT 06.06 PR: 1KE,1KP,1KT 06.06 PR: 1KE,1KP,1KT 06.06 PR: 1KE,1KP,1KT 06.06 PR: 1KE,1KP,1KT 06.06 PR: 1KE,1KP,1KT 06.06 PR: 1KE,1KP,1KT 06.06 PR: 1KE,1KP,1KT 06.06 PR: 1KE,1KP,1KT 06.06 PR: 1KE,1KP,1KT 06.06 PR: 1KE,1KP,1KT 06.06 PR: 1KE,1KP,1KT 06.06 PR: 1KE,1KP,1KT 06.06 PR: 1KE,1KP,1KT 06.06 PR: 1KE,1KP,1KT	G1020755		20961 17,1 /Acc/S	LUC
	1.8 4motion 1.9 TDI 4motion 1.9 TDI 4motion 1.9 TDI 4motion 1.9 TDI 4motion 2.0 4motion 2.3 V5 2.3 V5 4motion	92 66 74 85	05.99 04.01 05.99 09.00 11.99 04.00 05.99 05.99	06.06 PR: 2EE,2EL 06.06 PR: 2EE,2EL 06.06 PR: 2EE,2EL 06.06 PR: 2EE,2EL 06.06 PR: 2EE,2EL 06.06 PR: 2EE,2EL 06.06 PR: 2EE,2EL 06.06 PR: 2EE,2EL	G1020492		23554 17,1 /WD/S	LUC
	1.4 1.6 1.6 FSI 1.8 T 1.9 SDI 1.9 TDI 1.9 TDI 1.9 TDI 1.9 TDI 1.9 TDI 2.0 2.3 V5	110 66 74 81 85 96 85	05.99 05.99 01.02 05.00 05.99 05.99 09.00 05.99 05.99 04.01 05.99 05.99	06.06 PR: 1KP,1KT 06.06 PR: 1KP,1KT 06.06 PR: 1KP,1KT 06.06 PR: 1KP,1KT 06.06 PR: 1KP,1KT 06.06 PR: 1KP,1KT 06.06 PR: 1KP,1KT 06.06 PR: 1KP,1KT 06.06 PR: 1KP,1KT 06.06 PR: 1KP,1KT 06.06 PR: 1KP,1KT 06.06 PR: 1KP,1KT	G2109123		230 9,0 7,0 +S +C	
	1.8 4motion 1.9 TDI 4motion 1.9 TDI 4motion 1.9 TDI 4motion 2.0 4motion 2.3 V5 4motion 2.8 V6 4motion	92 66 74 85	05.99 04.01 05.99 09.00 11.99 04.00 05.99	06.06 PR: 1KE 06.06 PR: 1KE 06.06 PR: 1KE 06.06 PR: 1KE 06.06 PR: 1KE 06.06 PR: 1KE 06.06 PR: 1KE	G2109133		239 8,9 7,0 +S +C	
	1.8 4motion 1.9 TDI 4motion 1.9 TDI 4motion 1.9 TDI 4motion 2.0 4motion 2.3 V5 4motion	92 66 74 85	05.99 04.01 05.99 09.00 11.99 04.00 05.99	06.06 PR: 2EE,2EL 06.06 PR: 2EE,2EL 06.06 PR: 2EE,2EL 06.06 PR: 2EE,2EL 06.06 PR: 2EE,2EL 06.06 PR: 2EE,2EL 06.06 PR: 2EE,2EL	G2122163		256 22,0 20,0 V L +C	

**VOLKSWAGEN GOLF V (03-08)**

	1.4 16V 1.4 FSI 1.4 TSI 1.4 TSI 1.4 TSI 1.6 16V 1.6 FSI	66 103 125 75 85	10.03 05.07 05.06 11.05 01.04 10.03	09.08 PR: 1ZF,1ZM,1ZC 09.08 PR: 1ZF,1ZM,1ZC 09.08 PR: 1ZF,1ZM,1ZC 09.08 PR: 1ZF,1ZM,1ZC 09.08 PR: 1ZF,1ZM,1ZC 09.08 PR: 1ZF,1ZM,1ZC 09.08 PR: 1ZF,1ZM,1ZC	G1020463		23131 19,7 +/WI	VW
--	---	------------------------------	--	---	----------	--	-----------------	----





**VOLKSWAGEN GOLF V (03-08)**

	1.9 TDI	66		05.04	09.08	PR: 1ZF,1ZM,1ZC	<b>G1020463</b>		23131 19,7 +/Wl	<b>VW</b>
	1.9 TDI	77		10.03	09.08	PR: 1ZF,1ZM,1ZC				
	1.9 TDI 4motion	77		08.04	09.08	PR: 1ZF,1ZM,1ZC				
	2.0 FSI	110		10.03	09.08	PR: 1ZF,1ZM,1ZC				
	2.0 FSI 4motion	110		08.04	09.08	PR: 1ZF,1ZM,1ZC				
	2.0 GTI	147		09.04	09.08	PR: 1ZF,1ZM,1ZC				
	2.0 GTI	169		09.06	09.08	PR: 1ZF,1ZM,1ZC				
	2.0 SDI	55		01.04	09.08	PR: 1ZF,1ZM,1ZC				
	2.0 TDI	100		10.03	09.08	PR: 1ZF,1ZM,1ZC				
	2.0 TDI	103		10.03	09.08	PR: 1ZF,1ZM,1ZC				
	2.0 TDI	125		11.05	09.08	PR: 1ZF,1ZM,1ZC				
	2.0 TDI 4motion	103		08.04	09.08	PR: 1ZF,1ZM,1ZC				
	3.2 R32	184		11.05	09.08	PR: 1ZF,1ZM,1ZC				
	1.4 16V			10.03	09.08	PR: 1LJ,1LL,1LV,1ZD,1ZP,1ZE				
1.4 FSI	66		10.03	09.08	PR: 1LJ,1LL,1LV,1ZD,1ZP,1ZE					
1.4 TSI	90		05.07	09.08	PR: 1LJ,1LL,1LV,1ZD,1ZP,1ZE					
1.4 TSI	103		05.06	09.08	PR: 1LJ,1LL,1LV,1ZD,1ZP,1ZE					
1.4 TSI	125		11.05	09.08	PR: 1LJ,1LL,1LV,1ZD,1ZP,1ZE					
1.6 16V	75		01.04	09.08	PR: 1LJ,1LL,1LV,1ZD,1ZP,1ZE					
1.6 FSI	85		10.03	09.08	PR: 1LJ,1LL,1LV,1ZD,1ZP,1ZE					
1.9 TDI	66		05.04	09.08	PR: 1LJ,1LL,1LV,1ZD,1ZP,1ZE					
1.9 TDI	77		10.03	09.08	PR: 1LJ,1LL,1LV,1ZD,1ZP,1ZE					
1.9 TDI 4motion	77		08.04	09.08	PR: 1LJ,1LL,1LV,1ZD,1ZP,1ZE					
2.0 FSI	110		10.03	09.08	PR: 1LJ,1LL,1LV,1ZD,1ZP,1ZE					
2.0 FSI 4motion	110		08.04	09.08	PR: 1LJ,1LL,1LV,1ZD,1ZP,1ZE					
2.0 GTI	147		09.04	09.08	PR: 1LJ,1LL,1LV,1ZD,1ZP,1ZE					
2.0 GTI	169		09.06	09.08	PR: 1LJ,1LL,1LV,1ZD,1ZP,1ZE					
2.0 SDI	55		01.04	09.08	PR: 1LJ,1LL,1LV,1ZD,1ZP,1ZE					
2.0 TDI	100		10.03	09.08	PR: 1LJ,1LL,1LV,1ZD,1ZP,1ZE					
2.0 TDI	103		10.03	09.08	PR: 1LJ,1LL,1LV,1ZD,1ZP,1ZE					
2.0 TDI	125		11.05	09.08	PR: 1LJ,1LL,1LV,1ZD,1ZP,1ZE					
2.0 TDI 4motion	103		08.04	09.08	PR: 1LJ,1LL,1LV,1ZD,1ZP,1ZE					
3.2 R32	184		11.05	09.08	PR: 1LJ,1LL,1LV,1ZD,1ZP,1ZE					
1.4 16V			10.03	09.08	PR: 1LK,1LM	<b>G1020753</b>		23801 20,3 +/Wl	<b>ATE</b>	
1.4 FSI	66		10.03	09.08	PR: 1LK,1LM					
1.4 TSI	90		05.07	09.08	PR: 1LK,1LM					
1.4 TSI	103		05.06	09.08	PR: 1LK,1LM					
1.4 TSI	125		11.05	09.08	PR: 1LK,1LM					
1.6 16V	75		01.04	09.08	PR: 1LK,1LM					
1.6 FSI	85		10.03	09.08	PR: 1LK,1LM					
1.9 TDI	66		05.04	09.08	PR: 1LK,1LM					
1.9 TDI	77		10.03	09.08	PR: 1LK,1LM					
1.9 TDI 4motion	77		08.04	09.08	PR: 1LK,1LM					
2.0 FSI	110		10.03	09.08	PR: 1LK,1LM					
2.0 FSI 4motion	110		08.04	09.08	PR: 1LK,1LM					
2.0 GTI	147		09.04	09.08	PR: 1LK,1LM					
2.0 GTI	169		09.06	09.08	PR: 1LK,1LM					
2.0 SDI	55		01.04	09.08	PR: 1LK,1LM					
2.0 TDI	100		10.03	09.08	PR: 1LK,1LM					
2.0 TDI	103		10.03	09.08	PR: 1LK,1LM					
2.0 TDI	125		11.05	09.08	PR: 1LK,1LM					
2.0 TDI 4motion	103		08.04	09.08	PR: 1LK,1LM					
3.2 R32	184		11.05	09.08	PR: 1LK,1LM					
	1.4 16V			10.03	09.08	PR: 1ZF,1ZM,1ZC	<b>G2122210</b>		280 22,0 19,0 V L +S +C	
	1.4 FSI	66		10.03	09.08	PR: 1ZF,1ZM,1ZC				
	1.4 TSI	90		05.07	09.08	PR: 1ZF,1ZM,1ZC				
	1.4 TSI	103		05.06	09.08	PR: 1ZF,1ZM,1ZC				
	1.4 TSI	125		11.05	09.08	PR: 1ZF,1ZM,1ZC				
	1.6 16V	75		01.04	09.08	PR: 1ZF,1ZM,1ZC				
	1.6 FSI	85		10.03	09.08	PR: 1ZF,1ZM,1ZC				
	1.9 TDI	66		05.04	09.08	PR: 1ZF,1ZM,1ZC				
	1.9 TDI	77		10.03	09.08	PR: 1ZF,1ZM,1ZC				
	1.9 TDI 4motion	77		08.04	09.08	PR: 1ZF,1ZM,1ZC				
	2.0 FSI	110		10.03	09.08	PR: 1ZF,1ZM,1ZC				
	2.0 FSI 4motion	110		08.04	09.08	PR: 1ZF,1ZM,1ZC				
	2.0 GTI	147		09.04	09.08	PR: 1ZF,1ZM,1ZC				
	2.0 GTI	169		09.06	09.08	PR: 1ZF,1ZM,1ZC				
2.0 SDI	55		01.04	09.08	PR: 1ZF,1ZM,1ZC					
2.0 TDI	100		10.03	09.08	PR: 1ZF,1ZM,1ZC					
2.0 TDI	103		10.03	09.08	PR: 1ZF,1ZM,1ZC					
2.0 TDI	125		11.05	09.08	PR: 1ZF,1ZM,1ZC					
2.0 TDI 4motion	103		08.04	09.08	PR: 1ZF,1ZM,1ZC					
3.2 R32	184		11.05	09.08	PR: 1ZF,1ZM,1ZC					
1.4 16V			10.03	09.08	PR: 1ZE,1ZP	<b>G2125145</b>		288 25,0 22,0 V L +S +C		
1.4 FSI	66		10.03	09.08	PR: 1ZE,1ZP					
1.4 TSI	90		05.07	09.08	PR: 1ZE,1ZP					
1.4 TSI	103		05.06	09.08	PR: 1ZE,1ZP					
1.4 TSI	125		11.05	09.08	PR: 1ZE,1ZP					
1.6 16V	75		01.04	09.08	PR: 1ZE,1ZP					
1.6 FSI	85		10.03	09.08	PR: 1ZE,1ZP					
1.9 TDI	66		05.04	09.08	PR: 1ZE,1ZP					
1.9 TDI	77		10.03	09.08	PR: 1ZE,1ZP					
1.9 TDI 4motion	77		08.04	09.08	PR: 1ZE,1ZP					
2.0 FSI	110		10.03	09.08	PR: 1ZE,1ZP					
2.0 FSI 4motion	110		08.04	09.08	PR: 1ZE,1ZP					
2.0 GTI	147		09.04	09.08	PR: 1ZE,1ZP					
2.0 GTI	169		09.06	09.08	PR: 1ZE,1ZP					



**VOLKSWAGEN GOLF V (03-08)**

	2.0 SDI	55	01.04	09.08	PR: 1ZE,1ZP	G2125145		288 25,0 22,0 V L +S +C	
	2.0 TDI	100	10.03	09.08	PR: 1ZE,1ZP				
	2.0 TDI	103	10.03	09.08	PR: 1ZE,1ZP				
	2.0 TDI	125	11.05	09.08	PR: 1ZE,1ZP				
	2.0 TDI 4motion	103	08.04	09.08	PR: 1ZE,1ZP				
	3.2 R32	184	11.05	09.08	PR: 1ZE,1ZP	G2125145		288 25,0 22,0 V L +S +C	
		1.4 16V		10.03	09.08	PR: 1LJ,1LL,1LV,1ZD	G2125158		312 25,0 22,0 V L +S +C
		1.4 FSI	66	10.03	09.08	PR: 1LJ,1LL,1LV,1ZD			
		1.4 TSI	90	05.07	09.08	PR: 1LJ,1LL,1LV,1ZD			
		1.4 TSI	103	05.06	09.08	PR: 1LJ,1LL,1LV,1ZD			
		1.4 TSI	125	11.05	09.08	PR: 1LJ,1LL,1LV,1ZD			
		1.6 16V	75	01.04	09.08	PR: 1LJ,1LL,1LV,1ZD			
		1.6 FSI	85	10.03	09.08	PR: 1LJ,1LL,1LV,1ZD			
		1.9 TDI	66	05.04	09.08	PR: 1LJ,1LL,1LV,1ZD			
		1.9 TDI	77	10.03	09.08	PR: 1LJ,1LL,1LV,1ZD			
1.9 TDI 4motion		77	08.04	09.08	PR: 1LJ,1LL,1LV,1ZD				
2.0 FSI		110	10.03	09.08	PR: 1LJ,1LL,1LV,1ZD				
2.0 FSI 4motion		110	08.04	09.08	PR: 1LJ,1LL,1LV,1ZD				
2.0 GTI		147	09.04	09.08	PR: 1LJ,1LL,1LV,1ZD				
2.0 GTI		169	09.06	09.08	PR: 1LJ,1LL,1LV,1ZD				
2.0 SDI		55	01.04	09.08	PR: 1LJ,1LL,1LV,1ZD				
2.0 TDI		100	10.03	09.08	PR: 1LJ,1LL,1LV,1ZD				
2.0 TDI		103	10.03	09.08	PR: 1LJ,1LL,1LV,1ZD				
2.0 TDI		125	11.05	09.08	PR: 1LJ,1LL,1LV,1ZD				
2.0 TDI 4motion		103	08.04	09.08	PR: 1LJ,1LL,1LV,1ZD				
3.2 R32		184	11.05	09.08	PR: 1LJ,1LL,1LV,1ZD				
	1.4 16V		10.03	09.08	PR: 1LK,1LM	G2130115		345 30,0 27,0 V L +C	
	1.4 FSI	66	10.03	09.08	PR: 1LK,1LM				
	1.4 TSI	90	05.07	09.08	PR: 1LK,1LM				
	1.4 TSI	103	05.06	09.08	PR: 1LK,1LM				
	1.4 TSI	125	11.05	09.08	PR: 1LK,1LM				
	1.6 16V	75	01.04	09.08	PR: 1LK,1LM				
	1.6 FSI	85	10.03	09.08	PR: 1LK,1LM				
	1.9 TDI	66	05.04	09.08	PR: 1LK,1LM				
	1.9 TDI	77	10.03	09.08	PR: 1LK,1LM				
	1.9 TDI 4motion	77	08.04	09.08	PR: 1LK,1LM				
	2.0 FSI	110	10.03	09.08	PR: 1LK,1LM				
	2.0 FSI 4motion	110	08.04	09.08	PR: 1LK,1LM				
	2.0 GTI	147	09.04	09.08	PR: 1LK,1LM				
	2.0 GTI	169	09.06	09.08	PR: 1LK,1LM				
	2.0 SDI	55	01.04	09.08	PR: 1LK,1LM				
	2.0 TDI	100	10.03	09.08	PR: 1LK,1LM				
	2.0 TDI	103	10.03	09.08	PR: 1LK,1LM				
	2.0 TDI	125	11.05	09.08	PR: 1LK,1LM				
	2.0 TDI 4motion	103	08.04	09.08	PR: 1LK,1LM				
	3.2 R32	184	11.05	09.08	PR: 1LK,1LM				
	1.4 16V		10.03	09.08	PR: 1KD,1KQ	G1020492		23554 17,1 /WD/S LUC	
	1.4 FSI	66	10.03	09.08	PR: 1KD,1KQ				
	1.4 TSI	90	05.07	09.08	PR: 1KD,1KQ				
	1.4 TSI	103	05.06	09.08	PR: 1KD,1KQ				
	1.4 TSI	125	11.05	09.08	PR: 1KD,1KQ				
	1.6 16V	75	01.04	09.08	PR: 1KD,1KQ				
	1.6 FSI	85	10.03	09.08	PR: 1KD,1KQ				
	1.9 TDI	66	05.04	09.08	PR: 1KD,1KQ				
	1.9 TDI	77	10.03	09.08	PR: 1KD,1KQ				
	2.0 FSI	110	10.03	09.08	PR: 1KD,1KQ				
	2.0 GTI	147	09.04	09.08	PR: 1KD,1KQ				
	2.0 GTI	169	09.06	09.08	PR: 1KD,1KQ				
	2.0 SDI	55	01.04	09.08	PR: 1KD,1KQ				
	2.0 TDI	100	10.03	09.08	PR: 1KD,1KQ				
	2.0 TDI	103	10.03	09.08	PR: 1KD,1KQ				
2.0 TDI	125	11.05	09.08	PR: 1KD,1KQ					
	1.4 16V		10.03	09.08	PR: 1KY,1KZ,1KF,1KE,2EL	G1020682		23914 17,1 /WD/Acc/S LUC	
	1.4 FSI	66	10.03	09.08	PR: 1KY,1KZ,1KF,1KE,2EL				
	1.4 TSI	90	05.07	09.08	PR: 1KY,1KZ,1KF,1KE,2EL				
	1.4 TSI	103	05.06	09.08	PR: 1KY,1KZ,1KF,1KE,2EL				
	1.4 TSI	125	11.05	09.08	PR: 1KY,1KZ,1KF,1KE,2EL				
	1.6 16V	75	01.04	09.08	PR: 1KY,1KZ,1KF,1KE,2EL				
	1.6 FSI	85	10.03	09.08	PR: 1KY,1KZ,1KF,1KE,2EL				
	1.9 TDI	66	05.04	09.08	PR: 1KY,1KZ,1KF,1KE,2EL				
	1.9 TDI	77	10.03	09.08	PR: 1KY,1KZ,1KF,1KE,2EL				
	1.9 TDI 4motion	77	08.04	09.08	PR: 1KY,1KZ,1KF,1KE,2EL				
	2.0 FSI	110	10.03	09.08	PR: 1KY,1KZ,1KF,1KE,2EL				
	2.0 FSI 4motion	110	08.04	09.08	PR: 1KY,1KZ,1KF,1KE,2EL				
	2.0 GTI	147	09.04	09.08	PR: 1KY,1KZ,1KF,1KE,2EL				
	2.0 GTI	169	09.06	09.08	PR: 1KY,1KZ,1KF,1KE,2EL				
	2.0 SDI	55	01.04	09.08	PR: 1KY,1KZ,1KF,1KE,2EL				
2.0 TDI	100	10.03	09.08	PR: 1KY,1KZ,1KF,1KE,2EL					
2.0 TDI	103	10.03	09.08	PR: 1KY,1KZ,1KF,1KE,2EL					
2.0 TDI 4motion	103	08.04	09.08	PR: 1KY,1KZ,1KF,1KE,2EL					
3.2 R32	184	11.05	09.08	PR: 1KY,1KZ,1KF,1KE,2EL					
	1.4 16V		10.03	09.08	PR: 1KD,1KQ	G2110277		253 10,0 8,0 +S +C	
	1.4 FSI	66	10.03	09.08	PR: 1KD,1KQ				
	1.4 TSI	90	05.07	09.08	PR: 1KD,1KQ				
	1.4 TSI	103	05.06	09.08	PR: 1KD,1KQ				
	1.4 TSI	125	11.05	09.08	PR: 1KD,1KQ				

















**VOLKSWAGEN GOLF V (03-08)**

	1.6 16V	75		01.04	09.08	PR: 1KD,1KQ	G2110277		253 10,0 8,0 +S +C
	1.6 FSI	85		10.03	09.08	PR: 1KD,1KQ			
	1.9 TDI	66		05.04	09.08	PR: 1KD,1KQ			
	1.9 TDI	77		10.03	09.08	PR: 1KD,1KQ			
	2.0 FSI	110		10.03	09.08	PR: 1KD,1KQ			
	2.0 GTI	147		09.04	09.08	PR: 1KD,1KQ			
	2.0 GTI	169		09.06	09.08	PR: 1KD,1KQ			
	2.0 SDI	55		01.04	09.08	PR: 1KD,1KQ			
	2.0 TDI	100		10.03	09.08	PR: 1KD,1KQ			
	2.0 TDI	103		10.03	09.08	PR: 1KD,1KQ			
2.0 TDI	125		11.05	09.08	PR: 1KD,1KQ				
	1.4 16V			10.03	09.08	PR: 1KE,1KF	G2112158		256 12,0 10,0 +C
	1.4 FSI	66		10.03	09.08	PR: 1KE,1KF			
	1.4 TSI	90		05.07	09.08	PR: 1KE,1KF			
	1.4 TSI	103		05.06	09.08	PR: 1KE,1KF			
	1.4 TSI	125		11.05	09.08	PR: 1KE,1KF			
	1.6 16V	75		01.04	09.08	PR: 1KE,1KF			
	1.6 FSI	85		10.03	09.08	PR: 1KE,1KF			
	1.9 TDI	66		05.04	09.08	PR: 1KE,1KF			
	1.9 TDI	77		10.03	09.08	PR: 1KE,1KF			
	1.9 TDI 4motion	77		08.04	09.08	PR: 1KE,1KF			
	2.0 FSI	110		10.03	09.08	PR: 1KE,1KF			
	2.0 FSI 4motion	110		08.04	09.08	PR: 1KE,1KF			
	2.0 GTI	147		09.04	09.08	PR: 1KE,1KF			
	2.0 GTI	169		09.06	09.08	PR: 1KE,1KF			
	2.0 SDI	55		01.04	09.08	PR: 1KE,1KF			
	2.0 TDI	100		10.03	09.08	PR: 1KE,1KF			
	2.0 TDI	103		10.03	09.08	PR: 1KE,1KF			
	2.0 TDI	125		11.05	09.08	PR: 1KE,1KF			
2.0 TDI 4motion	103		08.04	09.08	PR: 1KE,1KF				
3.2 R32	184		11.05	09.08	PR: 1KE,1KF				
	1.4 16V			10.03	09.08	PR: 1KY,1KZ,1KV	G2112169		282 12,0 10,0 +S +C
	1.4 FSI	66		10.03	09.08	PR: 1KY,1KZ,1KV			
	1.4 TSI	90		05.07	09.08	PR: 1KY,1KZ,1KV			
	1.4 TSI	103		05.06	09.08	PR: 1KY,1KZ,1KV			
	1.4 TSI	125		11.05	09.08	PR: 1KY,1KZ,1KV			
	1.6 16V	75		01.04	09.08	PR: 1KY,1KZ,1KV			
	1.6 FSI	85		10.03	09.08	PR: 1KY,1KZ,1KV			
	1.9 TDI	66		05.04	09.08	PR: 1KY,1KZ,1KV			
	1.9 TDI	77		10.03	09.08	PR: 1KY,1KZ,1KV			
	2.0 FSI	110		10.03	09.08	PR: 1KY,1KZ,1KV			
	2.0 GTI	147		09.04	09.08	PR: 1KY,1KZ,1KV			
	2.0 GTI	169		09.06	09.08	PR: 1KY,1KZ,1KV			
	2.0 SDI	55		01.04	09.08	PR: 1KY,1KZ,1KV			
	2.0 TDI	100		10.03	09.08	PR: 1KY,1KZ,1KV			
	2.0 TDI	103		10.03	09.08	PR: 1KY,1KZ,1KV			
	2.0 TDI	125		11.05	09.08	PR: 1KY,1KZ,1KV			

**VOLKSWAGEN GOLF V Variant (07-09)**

	1.4	59		06.07	06.09	PR: 1ZM	G1020463		23131 19,7 +/Wl	VW
	1.4 TSI	90		06.07	06.09	PR: 1ZM				
	1.4 TSI	103		05.07	06.09	PR: 1ZM				
	1.4 TSI	118		07.08	06.09	PR: 1ZM				
	1.4 TSI	125		05.07	06.09	PR: 1ZM				
	1.6	75		05.07	06.09	PR: 1ZM				
	1.9 TDI	77		05.07	06.09	PR: 1ZM				
	1.9 TDI 4motion	77		12.07	06.09	PR: 1ZM				
	2.0	147		06.07	06.09	PR: 1ZM				
	2.0 TDI			05.07	06.09	PR: 1ZM				
	1.4	59		06.07	06.09	PR: 1LJ,1ZD,1ZE,1ZP	G1020680		23587 20,6 +/Wl	ATE
	1.4 TSI	90		06.07	06.09	PR: 1LJ,1ZD,1ZE,1ZP				
	1.4 TSI	103		05.07	06.09	PR: 1LJ,1ZD,1ZE,1ZP				
	1.4 TSI	118		07.08	06.09	PR: 1LJ,1ZD,1ZE,1ZP				
	1.4 TSI	125		05.07	06.09	PR: 1LJ,1ZD,1ZE,1ZP				
	1.6	75		05.07	06.09	PR: 1LJ,1ZD,1ZE,1ZP				
	1.9 TDI	77		05.07	06.09	PR: 1LJ,1ZD,1ZE,1ZP				
	1.9 TDI 4motion	77		12.07	06.09	PR: 1LJ,1ZD,1ZE,1ZP				
	2.0	147		06.07	06.09	PR: 1LJ,1ZD,1ZE,1ZP				
	2.0 TDI			05.07	06.09	PR: 1LJ,1ZD,1ZE,1ZP				
	1.4	59		06.07	06.09	PR: 1ZM	G2122210		280 22,0 19,0 V L +S +C	
	1.4 TSI	90		06.07	06.09	PR: 1ZM				
	1.4 TSI	103		05.07	06.09	PR: 1ZM				
	1.4 TSI	118		07.08	06.09	PR: 1ZM				
	1.4 TSI	125		05.07	06.09	PR: 1ZM				
	1.6	75		05.07	06.09	PR: 1ZM				
	1.9 TDI	77		05.07	06.09	PR: 1ZM				
	1.9 TDI 4motion	77		12.07	06.09	PR: 1ZM				
	2.0	147		06.07	06.09	PR: 1ZM				
	2.0 TDI			05.07	06.09	PR: 1ZM				
	1.4	59		06.07	06.09	PR: 1ZE,1ZP	G2125145		288 25,0 22,0 V L +S +C	
	1.4 TSI	90		06.07	06.09	PR: 1ZE,1ZP				
	1.4 TSI	103		05.07	06.09	PR: 1ZE,1ZP				
	1.4 TSI	118		07.08	06.09	PR: 1ZE,1ZP				
	1.4 TSI	125		05.07	06.09	PR: 1ZE,1ZP				
	1.6	75		05.07	06.09	PR: 1ZE,1ZP				
	1.9 TDI	77		05.07	06.09	PR: 1ZE,1ZP				
	1.9 TDI 4motion	77		12.07	06.09	PR: 1ZE,1ZP				

									
<b>VOLKSWAGEN GOLF V Variant (07-09)</b>									
	2.0	147		06.07	06.09	PR: 1ZE,1ZP	G2125145		288 25,0 22,0 V L +S +C
	2.0 TDI			05.07	06.09	PR: 1ZE,1ZP			
	1.4	59		06.07	06.09	PR: 1LJ,1ZD	G2125158		312 25,0 22,0 V L +S +C
	1.4 TSI	90		06.07	06.09	PR: 1LJ,1ZD			
	1.4 TSI	103		05.07	06.09	PR: 1LJ,1ZD			
	1.4 TSI	118		07.08	06.09	PR: 1LJ,1ZD			
	1.4 TSI	125		05.07	06.09	PR: 1LJ,1ZD			
	1.6	75		05.07	06.09	PR: 1LJ,1ZD			
	1.9 TDI	77		05.07	06.09	PR: 1LJ,1ZD			
	1.9 TDI 4motion	77		12.07	06.09	PR: 1LJ,1ZD			
2.0	147		06.07	06.09	PR: 1LJ,1ZD				
2.0 TDI			05.07	06.09	PR: 1LJ,1ZD				
	1.4	59		06.07	06.09	PR: 1KE,1KF,1KJ	G1020682		23914 17,1 /WD/Acc/S LUC
	1.4 TSI	90		06.07	06.09	PR: 1KE,1KF,1KJ			
	1.4 TSI	103		05.07	06.09	PR: 1KE,1KF,1KJ			
	1.4 TSI	118		07.08	06.09	PR: 1KE,1KF,1KJ			
	1.4 TSI	125		05.07	06.09	PR: 1KE,1KF,1KJ			
	1.6	75		05.07	06.09	PR: 1KE,1KF,1KJ			
	1.9 TDI	77		05.07	06.09	PR: 1KE,1KF,1KJ			
	1.9 TDI 4motion	77		12.07	06.09	PR: 1KE,1KF,1KJ			
	2.0	147		06.07	06.09	PR: 1KE,1KF,1KJ			
	2.0 TDI			05.07	06.09	PR: 1KE,1KF,1KJ			
	1.4	59		06.07	06.09	PR: 1KE,1KF	G2112158		256 12,0 10,0 +C
	1.4 TSI	90		06.07	06.09	PR: 1KE,1KF			
	1.4 TSI	103		05.07	06.09	PR: 1KE,1KF			
	1.4 TSI	118		07.08	06.09	PR: 1KE,1KF			
	1.4 TSI	125		05.07	06.09	PR: 1KE,1KF			
	1.6	75		05.07	06.09	PR: 1KE,1KF			
	1.9 TDI	77		05.07	06.09	PR: 1KE,1KF			
	1.9 TDI 4motion	77		12.07	06.09	PR: 1KE,1KF			
	2.0	147		06.07	06.09	PR: 1KE,1KF			
	2.0 TDI			05.07	06.09	PR: 1KE,1KF			
	1.4	59		06.07	06.09	PR: 1KJ	G2112169		282 12,0 10,0 +S +C
	1.4 TSI	90		06.07	06.09	PR: 1KJ			
	1.4 TSI	103		05.07	06.09	PR: 1KJ			
	1.4 TSI	118		07.08	06.09	PR: 1KJ			
	1.4 TSI	125		05.07	06.09	PR: 1KJ			
	1.6	75		05.07	06.09	PR: 1KJ			
	1.9 TDI	77		05.07	06.09	PR: 1KJ			
	1.9 TDI 4motion	77		12.07	06.09	PR: 1KJ			
	2.0	147		06.07	06.09	PR: 1KJ			
	2.0 TDI			05.07	06.09	PR: 1KJ			
<b>VOLKSWAGEN GOLF VI (08-)</b>									
	1.2 TSI			05.09		PR: 1ZF	G1020463		23131 19,7 +/WI WW
	1.4	59		10.08		PR: 1ZF			
	1.4 TSI	90		10.08		PR: 1ZF			
	1.4 TSI	118		10.08		PR: 1ZF			
	1.6	75		10.08		PR: 1ZF			
	1.6 Bi-Fuel	75		03.09		PR: 1ZF			
	1.6 TDI	66		02.09		PR: 1ZF			
	1.6 TDI	77		02.09		PR: 1ZF			
	1.8 TSI	118		06.09		PR: 1ZF			
	2.0 GTi			04.09		PR: 1ZF			
	2.0 R 4motion			11.09		PR: 1ZF			
	2.0 TDI	81		10.08		PR: 1ZF			
	2.0 TDI	100		10.08		PR: 1ZF			
	2.0 TDI	103		10.08		PR: 1ZF			
	2.0 TDI	125		04.09		PR: 1ZF			
2.0 TDI 4motion	103		10.08		PR: 1ZF				
	1.2 TSI			05.09		PR: 1ZA,1ZB,1ZD,1ZE,1ZP,1LJ,1LL	G1020680		23587 20,6 +/WI ATE
	1.4	59		10.08		PR: 1ZA,1ZB,1ZD,1ZE,1ZP,1LJ,1LL			
	1.4 TSI	90		10.08		PR: 1ZA,1ZB,1ZD,1ZE,1ZP,1LJ,1LL			
	1.4 TSI	118		10.08		PR: 1ZA,1ZB,1ZD,1ZE,1ZP,1LJ,1LL			
	1.6	75		10.08		PR: 1ZA,1ZB,1ZD,1ZE,1ZP,1LJ,1LL			
	1.6 Bi-Fuel	75		03.09		PR: 1ZA,1ZB,1ZD,1ZE,1ZP,1LJ,1LL			
	1.6 TDI	66		02.09		PR: 1ZA,1ZB,1ZD,1ZE,1ZP,1LJ,1LL			
	1.6 TDI	77		02.09		PR: 1ZA,1ZB,1ZD,1ZE,1ZP,1LJ,1LL			
	1.8 TSI	118		06.09		PR: 1ZA,1ZB,1ZD,1ZE,1ZP,1LJ,1LL			
	2.0 GTi			04.09		PR: 1ZA,1ZB,1ZD,1ZE,1ZP,1LJ,1LL			
	2.0 R 4motion			11.09		PR: 1ZA,1ZB,1ZD,1ZE,1ZP,1LJ,1LL			
	2.0 TDI	81		10.08		PR: 1ZA,1ZB,1ZD,1ZE,1ZP,1LJ,1LL			
	2.0 TDI	100		10.08		PR: 1ZA,1ZB,1ZD,1ZE,1ZP,1LJ,1LL			
	2.0 TDI	103		10.08		PR: 1ZA,1ZB,1ZD,1ZE,1ZP,1LJ,1LL			
	2.0 TDI	125		04.09		PR: 1ZA,1ZB,1ZD,1ZE,1ZP,1LJ,1LL			
2.0 TDI 4motion	103		10.08		PR: 1ZA,1ZB,1ZD,1ZE,1ZP,1LJ,1LL				
	1.2 TSI			05.09		PR: 1LM	G1020753		23801 20,3 +/WI ATE
	1.4	59		10.08		PR: 1LM			
	1.4 TSI	90		10.08		PR: 1LM			
	1.4 TSI	118		10.08		PR: 1LM			
	1.6	75		10.08		PR: 1LM			
	1.6 Bi-Fuel	75		03.09		PR: 1LM			
	1.6 TDI	66		02.09		PR: 1LM			
	1.6 TDI	77		02.09		PR: 1LM			
	1.8 TSI	118		06.09		PR: 1LM			
	2.0 GTi			04.09		PR: 1LM			
2.0 R 4motion			11.09		PR: 1LM				





**VOLKSWAGEN GOLF VI (08-)**

	2.0 TDI	81	10.08	PR: 1LM	G1020753	23801 20,3 +/Wl	ATE
	2.0 TDI	100	10.08	PR: 1LM			
	2.0 TDI	103	10.08	PR: 1LM			
	2.0 TDI	125	04.09	PR: 1LM			
	2.0 TDI 4motion	103	10.08	PR: 1LM			
	1.2 TSI		05.09	PR: 1ZK	G1020895	23801 20,3 +/Wl	ATE
	1.4	59	10.08	PR: 1ZK			
	1.4 TSI	90	10.08	PR: 1ZK			
	1.4 TSI	118	10.08	PR: 1ZK			
	1.6	75	10.08	PR: 1ZK			
1.6 Bi-Fuel	75	03.09	PR: 1ZK				
1.6 TDI	66	02.09	PR: 1ZK				
1.6 TDI	77	02.09	PR: 1ZK				
1.8 TSI	118	06.09	PR: 1ZK				
2.0 GTi		04.09	PR: 1ZK				
2.0 R 4motion		11.09	PR: 1ZK				
2.0 TDI	81	10.08	PR: 1ZK				
2.0 TDI	100	10.08	PR: 1ZK				
2.0 TDI	103	10.08	PR: 1ZK				
2.0 TDI	125	04.09	PR: 1ZK				
2.0 TDI 4motion	103	10.08	PR: 1ZK				
	1.2 TSI		05.09	PR: 1ZF	G2122210	280 22,0 19,0 V L +S +C	
	1.4	59	10.08	PR: 1ZF			
	1.4 TSI	90	10.08	PR: 1ZF			
	1.4 TSI	118	10.08	PR: 1ZF			
	1.6	75	10.08	PR: 1ZF			
	1.6 Bi-Fuel	75	03.09	PR: 1ZF			
	1.6 TDI	66	02.09	PR: 1ZF			
	1.6 TDI	77	02.09	PR: 1ZF			
	1.8 TSI	118	06.09	PR: 1ZF			
	2.0 GTi		04.09	PR: 1ZF			
2.0 R 4motion		11.09	PR: 1ZF				
2.0 TDI	81	10.08	PR: 1ZF				
2.0 TDI	100	10.08	PR: 1ZF				
2.0 TDI	103	10.08	PR: 1ZF				
2.0 TDI	125	04.09	PR: 1ZF				
2.0 TDI 4motion	103	10.08	PR: 1ZF				
	1.2 TSI		05.09	PR: 1ZE,1ZP	G2125145	288 25,0 22,0 V L +S +C	
	1.4	59	10.08	PR: 1ZE,1ZP			
	1.4 TSI	90	10.08	PR: 1ZE,1ZP			
	1.4 TSI	118	10.08	PR: 1ZE,1ZP			
	1.6	75	10.08	PR: 1ZE,1ZP			
	1.6 Bi-Fuel	75	03.09	PR: 1ZE,1ZP			
	1.6 TDI	66	02.09	PR: 1ZE,1ZP			
	1.6 TDI	77	02.09	PR: 1ZE,1ZP			
	1.8 TSI	118	06.09	PR: 1ZE,1ZP			
	2.0 GTi		04.09	PR: 1ZE,1ZP			
2.0 R 4motion		11.09	PR: 1ZE,1ZP				
2.0 TDI	81	10.08	PR: 1ZE,1ZP				
2.0 TDI	100	10.08	PR: 1ZE,1ZP				
2.0 TDI	103	10.08	PR: 1ZE,1ZP				
2.0 TDI	125	04.09	PR: 1ZE,1ZP				
2.0 TDI 4motion	103	10.08	PR: 1ZE,1ZP				
	1.2 TSI		05.09	PR: 1LJ,1LL,1LV,1ZA,1ZB,1ZD	G2125158	312 25,0 22,0 V L +S +C	
	1.4	59	10.08	PR: 1LJ,1LL,1LV,1ZA,1ZB,1ZD			
	1.4 TSI	90	10.08	PR: 1LJ,1LL,1LV,1ZA,1ZB,1ZD			
	1.4 TSI	118	10.08	PR: 1LJ,1LL,1LV,1ZA,1ZB,1ZD			
	1.6	75	10.08	PR: 1LJ,1LL,1LV,1ZA,1ZB,1ZD			
	1.6 Bi-Fuel	75	03.09	PR: 1LJ,1LL,1LV,1ZA,1ZB,1ZD			
	1.6 TDI	66	02.09	PR: 1LJ,1LL,1LV,1ZA,1ZB,1ZD			
	1.6 TDI	77	02.09	PR: 1LJ,1LL,1LV,1ZA,1ZB,1ZD			
	1.8 TSI	118	06.09	PR: 1LJ,1LL,1LV,1ZA,1ZB,1ZD			
	2.0 GTi		04.09	PR: 1LJ,1LL,1LV,1ZA,1ZB,1ZD			
2.0 R 4motion		11.09	PR: 1LJ,1LL,1LV,1ZA,1ZB,1ZD				
2.0 TDI	81	10.08	PR: 1LJ,1LL,1LV,1ZA,1ZB,1ZD				
2.0 TDI	100	10.08	PR: 1LJ,1LL,1LV,1ZA,1ZB,1ZD				
2.0 TDI	103	10.08	PR: 1LJ,1LL,1LV,1ZA,1ZB,1ZD				
2.0 TDI	125	04.09	PR: 1LJ,1LL,1LV,1ZA,1ZB,1ZD				
2.0 TDI 4motion	103	10.08	PR: 1LJ,1LL,1LV,1ZA,1ZB,1ZD				
	1.2 TSI		05.09	PR: 1LM,1ZK	G2130115	345 30,0 27,0 V L +C	
	1.4	59	10.08	PR: 1LM,1ZK			
	1.4 TSI	90	10.08	PR: 1LM,1ZK			
	1.4 TSI	118	10.08	PR: 1LM,1ZK			
	1.6	75	10.08	PR: 1LM,1ZK			
	1.6 Bi-Fuel	75	03.09	PR: 1LM,1ZK			
	1.6 TDI	66	02.09	PR: 1LM,1ZK			
	1.6 TDI	77	02.09	PR: 1LM,1ZK			
	1.8 TSI	118	06.09	PR: 1LM,1ZK			
	2.0 GTi		04.09	PR: 1LM,1ZK			
2.0 R 4motion		11.09	PR: 1LM,1ZK				
2.0 TDI	81	10.08	PR: 1LM,1ZK				
2.0 TDI	100	10.08	PR: 1LM,1ZK				
2.0 TDI	103	10.08	PR: 1LM,1ZK				
2.0 TDI	125	04.09	PR: 1LM,1ZK				
2.0 TDI 4motion	103	10.08	PR: 1LM,1ZK				



**VOLKSWAGEN GOLF VI (08-)**

	1.2 TSI		05.09	PR: 1KD	G1020492	23554 17,1 /WD/S	LUC
	1.4	59	10.08	PR: 1KD			
	1.4 TSI	90	10.08	PR: 1KD			
	1.4 TSI	118	10.08	PR: 1KD			
	1.6	75	10.08	PR: 1KD			
	1.6 Bi-Fuel	75	03.09	PR: 1KD			
	1.6 TDI	66	02.09	PR: 1KD			
	1.6 TDI	77	02.09	PR: 1KD			
	1.8 TSI	118	06.09	PR: 1KD			
	2.0 GTi		04.09	PR: 1KD			
	2.0 TDI	81	10.08	PR: 1KD			
	2.0 TDI	100	10.08	PR: 1KD			
	2.0 TDI	103	10.08	PR: 1KD			
	2.0 TDI	125	04.09	PR: 1KD			
	1.2 TSI		05.09	PR: 1KF,1KY,1KZ,1KE,1KV	G1020682	23914 17,1 /WD/Acc/S	LUC
	1.4	59	10.08	PR: 1KF,1KY,1KZ,1KE,1KV			
	1.4 TSI	90	10.08	PR: 1KF,1KY,1KZ,1KE,1KV			
	1.4 TSI	118	10.08	PR: 1KF,1KY,1KZ,1KE,1KV			
	1.6	75	10.08	PR: 1KF,1KY,1KZ,1KE,1KV			
	1.6 Bi-Fuel	75	03.09	PR: 1KF,1KY,1KZ,1KE,1KV			
	1.6 TDI	66	02.09	PR: 1KF,1KY,1KZ,1KE,1KV			
	1.6 TDI	77	02.09	PR: 1KF,1KY,1KZ,1KE,1KV			
	1.8 TSI	118	06.09	PR: 1KF,1KY,1KZ,1KE,1KV			
	2.0 GTi		04.09	PR: 1KF,1KY,1KZ,1KE,1KV			
	2.0 R 4motion		11.09	PR: 1KF,1KY,1KZ,1KE,1KV,2EL			
	2.0 TDI	81	10.08	PR: 1KF,1KY,1KZ,1KE,1KV			
	2.0 TDI	100	10.08	PR: 1KF,1KY,1KZ,1KE,1KV			
	2.0 TDI	103	10.08	PR: 1KF,1KY,1KZ,1KE,1KV			
2.0 TDI	125	04.09	PR: 1KF,1KY,1KZ,1KE,1KV				
2.0 TDI 4motion	103	10.08	PR: 1KF,1KY,1KZ,1KE,1KV,2EL				
	1.2 TSI		05.09	PR: 1KD	G2110277	253 10,0 8,0 +S +C	
	1.4	59	10.08	PR: 1KD			
	1.4 TSI	90	10.08	PR: 1KD			
	1.4 TSI	118	10.08	PR: 1KD			
	1.6	75	10.08	PR: 1KD			
	1.6 Bi-Fuel	75	03.09	PR: 1KD			
	1.6 TDI	66	02.09	PR: 1KD			
	1.6 TDI	77	02.09	PR: 1KD			
	1.8 TSI	118	06.09	PR: 1KD			
	2.0 GTi		04.09	PR: 1KD			
	2.0 TDI	81	10.08	PR: 1KD			
	2.0 TDI	100	10.08	PR: 1KD			
	2.0 TDI	103	10.08	PR: 1KD			
	2.0 TDI	125	04.09	PR: 1KD			
	1.2 TSI		05.09	PR: 1KV,1KY,1KZ	G2112169	282 12,0 10,0 +S +C	
	1.4	59	10.08	PR: 1KV,1KY,1KZ			
	1.4 TSI	90	10.08	PR: 1KV,1KY,1KZ			
	1.4 TSI	118	10.08	PR: 1KV,1KY,1KZ			
	1.6	75	10.08	PR: 1KV,1KY,1KZ			
	1.6 Bi-Fuel	75	03.09	PR: 1KV,1KY,1KZ			
	1.6 TDI	66	02.09	PR: 1KV,1KY,1KZ			
	1.6 TDI	77	02.09	PR: 1KV,1KY,1KZ			
	1.8 TSI	118	06.09	PR: 1KV,1KY,1KZ			
	2.0 GTi		04.09	PR: 1KV,1KY,1KZ			
	2.0 TDI	81	10.08	PR: 1KV,1KY,1KZ			
	2.0 TDI	100	10.08	PR: 1KV,1KY,1KZ			
	2.0 TDI	103	10.08	PR: 1KV,1KY,1KZ			
	2.0 TDI	125	04.09	PR: 1KV,1KY,1KZ			
	1.2 TSI		05.09	PR: 1KE,1KF	G2112158	256 12,0 10,0 +C	
	1.4	59	10.08	PR: 1KE,1KF			
	1.4 TSI	90	10.08	PR: 1KE,1KF			
	1.4 TSI	118	10.08	PR: 1KE,1KF			
	1.6	75	10.08	PR: 1KE,1KF			
	1.6 Bi-Fuel	75	03.09	PR: 1KE,1KF			
	1.6 TDI	66	02.09	PR: 1KE,1KF			
	1.6 TDI	77	02.09	PR: 1KE,1KF			
	1.8 TSI	118	06.09	PR: 1KE,1KF			
	2.0 GTi		04.09	PR: 1KE,1KF			
	2.0 R 4motion		11.09	PR: 1KE,1KF			
	2.0 TDI	81	10.08	PR: 1KE,1KF			
	2.0 TDI	100	10.08	PR: 1KE,1KF			
	2.0 TDI	103	10.08	PR: 1KE,1KF			
2.0 TDI	125	04.09	PR: 1KE,1KF				
2.0 TDI 4motion	103	10.08	PR: 1KE,1KF				
	1.2 TSI		05.09	PR: 1KS,1KT	G2110356	272 9,7 8,0 +S +C	
	1.4	59	10.08	PR: 1KS,1KT			
	1.4 TSI	90	10.08	PR: 1KS,1KT			
	1.4 TSI	118	10.08	PR: 1KS,1KT			
	1.6	75	10.08	PR: 1KS,1KT			
	1.6 Bi-Fuel	75	03.09	PR: 1KS,1KT			
	1.6 TDI	66	02.09	PR: 1KS,1KT			
	1.6 TDI	77	02.09	PR: 1KS,1KT			
	1.8 TSI	118	06.09	PR: 1KS,1KT			
	2.0 GTi		04.09	PR: 1KS,1KT			
	2.0 R 4motion		11.09	PR: 1KS,1KT			
	2.0 TDI	81	10.08	PR: 1KS,1KT			
	2.0 TDI	100	10.08	PR: 1KS,1KT			
	2.0 TDI	103	10.08	PR: 1KS,1KT			
2.0 TDI	125	10.08	PR: 1KS,1KT				



















**VOLKSWAGEN GOLF VI (08-)**

	2.0 TDI	103		<b>10.08</b>	PR: 1KS,1KT	<b>G2110356</b>		272 9,7 8,0 +S +C
	2.0 TDI	125		<b>04.09</b>	PR: 1KS,1KT			
	2.0 TDI 4motion	103		<b>10.08</b>	PR: 1KS,1KT			

**VOLKSWAGEN GOLF VI Variant (09-)**

	1.2 TSI			<b>08.09</b>	PR: 12M	<b>G1020463</b>		<b>23131</b> 19,7 +/WI <b>VW</b>
	1.4	59		<b>07.09</b>	PR: 12M			
	1.4 TSI	90		<b>07.09</b>	PR: 12M			
	1.4 TSI	118		<b>07.09</b>	PR: 12M			
	1.6	75		<b>07.09</b>	PR: 12M			
	1.6 MultiFuel	75		<b>07.09</b>	PR: 12M			
	1.6 TDI			<b>07.09</b>	PR: 12M			
	1.6 TDI 4motion	77		<b>07.09</b>	PR: 12M			
	2.0	147		<b>07.09</b>	PR: 12M			
	2.0 TDI			<b>07.09</b>	PR: 12M			
	1.2 TSI			<b>08.09</b>	PR: 12A,12D,1ZE,12P,1LJ	<b>G1020680</b>		<b>23587</b> 20,6 +/WI <b>ATE</b>
	1.4	59		<b>07.09</b>	PR: 12A,12D,1ZE,12P,1LJ			
	1.4 TSI	90		<b>07.09</b>	PR: 12A,12D,1ZE,12P,1LJ			
	1.4 TSI	118		<b>07.09</b>	PR: 12A,12D,1ZE,12P,1LJ			
	1.6	75		<b>07.09</b>	PR: 12A,12D,1ZE,12P,1LJ			
	1.6 MultiFuel	75		<b>07.09</b>	PR: 12A,12D,1ZE,12P,1LJ			
	1.6 TDI			<b>07.09</b>	PR: 12A,12D,1ZE,12P,1LJ			
	1.6 TDI 4motion	77		<b>07.09</b>	PR: 12A,12D,1ZE,12P,1LJ			
	2.0	147		<b>07.09</b>	PR: 12A,12D,1ZE,12P,1LJ			
	2.0 TDI			<b>07.09</b>	PR: 12A,12D,1ZE,12P,1LJ			
	1.2 TSI			<b>08.09</b>	PR: 12M	<b>G2122210</b>		280 22,0 19,0 V L +S +C
	1.4	59		<b>07.09</b>	PR: 12M			
	1.4 TSI	90		<b>07.09</b>	PR: 12M			
	1.4 TSI	118		<b>07.09</b>	PR: 12M			
	1.6	75		<b>07.09</b>	PR: 12M			
	1.6 MultiFuel	75		<b>07.09</b>	PR: 12M			
	1.6 TDI			<b>07.09</b>	PR: 12M			
	1.6 TDI 4motion	77		<b>07.09</b>	PR: 12M			
	2.0	147		<b>07.09</b>	PR: 12M			
	2.0 TDI			<b>07.09</b>	PR: 12M			
	1.2 TSI			<b>08.09</b>	PR: 1LJ,1ZA,12D	<b>G2125158</b>		312 25,0 22,0 V L +S +C
	1.4	59		<b>07.09</b>	PR: 1LJ,1ZA,12D			
	1.4 TSI	90		<b>07.09</b>	PR: 1LJ,1ZA,12D			
	1.4 TSI	118		<b>07.09</b>	PR: 1LJ,1ZA,12D			
	1.6	75		<b>07.09</b>	PR: 1LJ,1ZA,12D			
	1.6 MultiFuel	75		<b>07.09</b>	PR: 1LJ,1ZA,12D			
	1.6 TDI			<b>07.09</b>	PR: 1LJ,1ZA,12D			
	1.6 TDI 4motion	77		<b>07.09</b>	PR: 1LJ,1ZA,12D			
	2.0	147		<b>07.09</b>	PR: 1LJ,1ZA,12D			
	2.0 TDI			<b>07.09</b>	PR: 1LJ,1ZA,12D			
	1.2 TSI			<b>08.09</b>	PR: 1ZE,1ZP	<b>G2125145</b>		288 25,0 22,0 V L +S +C
	1.4	59		<b>07.09</b>	PR: 1ZE,1ZP			
	1.4 TSI	90		<b>07.09</b>	PR: 1ZE,1ZP			
	1.4 TSI	118		<b>07.09</b>	PR: 1ZE,1ZP			
	1.6	75		<b>07.09</b>	PR: 1ZE,1ZP			
	1.6 MultiFuel	75		<b>07.09</b>	PR: 1ZE,1ZP			
	1.6 TDI			<b>07.09</b>	PR: 1ZE,1ZP			
	1.6 TDI 4motion	77		<b>07.09</b>	PR: 1ZE,1ZP			
	2.0	147		<b>07.09</b>	PR: 1ZE,1ZP			
	2.0 TDI			<b>07.09</b>	PR: 1ZE,1ZP			
	1.2 TSI			<b>08.09</b>	PR: 1KE,1KF,1KJ	<b>G1020682</b>		<b>23914</b> 17,1 /WD/Acc/S <b>LUC</b>
	1.4	59		<b>07.09</b>	PR: 1KE,1KF,1KJ			
	1.4 TSI	90		<b>07.09</b>	PR: 1KE,1KF,1KJ			
	1.4 TSI	118		<b>07.09</b>	PR: 1KE,1KF,1KJ			
	1.6	75		<b>07.09</b>	PR: 1KE,1KF,1KJ			
	1.6 MultiFuel	75		<b>07.09</b>	PR: 1KE,1KF,1KJ			
	1.6 TDI			<b>07.09</b>	PR: 1KE,1KF,1KJ			
	1.6 TDI 4motion	77		<b>07.09</b>	PR: 1KE,1KF,1KJ			
	2.0	147		<b>07.09</b>	PR: 1KE,1KF,1KJ			
	2.0 TDI			<b>07.09</b>	PR: 1KE,1KF,1KJ			
	1.2 TSI			<b>08.09</b>	PR: 1KS	<b>G2110356</b>		272 9,7 8,0 +S +C
	1.4	59		<b>07.09</b>	PR: 1KS			
	1.4 TSI	90		<b>07.09</b>	PR: 1KS			
	1.4 TSI	118		<b>07.09</b>	PR: 1KS			
	1.6	75		<b>07.09</b>	PR: 1KS			
	1.6 MultiFuel	75		<b>07.09</b>	PR: 1KS			
	1.6 TDI			<b>07.09</b>	PR: 1KS			
	1.6 TDI 4motion	77		<b>07.09</b>	PR: 1KS			
	2.0	147		<b>07.09</b>	PR: 1KS			
	2.0 TDI			<b>07.09</b>	PR: 1KS			
	1.2 TSI			<b>08.09</b>	PR: 1KE,1KF	<b>G2112158</b>		256 12,0 10,0 +C
	1.4	59		<b>07.09</b>	PR: 1KE,1KF			
	1.4 TSI	90		<b>07.09</b>	PR: 1KE,1KF			
	1.4 TSI	118		<b>07.09</b>	PR: 1KE,1KF			
	1.6	75		<b>07.09</b>	PR: 1KE,1KF			
	1.6 MultiFuel	75		<b>07.09</b>	PR: 1KE,1KF			
	1.6 TDI			<b>07.09</b>	PR: 1KE,1KF			
	1.6 TDI 4motion	77		<b>07.09</b>	PR: 1KE,1KF			
	2.0	147		<b>07.09</b>	PR: 1KE,1KF			
	2.0 TDI			<b>07.09</b>	PR: 1KE,1KF			
	1.2 TSI			<b>08.09</b>	PR: 1KJ	<b>G2112169</b>		282 12,0 10,0 +S +C

								
<b>VOLKSWAGEN GOLF VI Variant (09-)</b>								
	1.4	59		07.09	PR: 1KJ	G2112169		282 12,0 10,0 +S +C
	1.4 TSI	90		07.09	PR: 1KJ			
	1.4 TSI	118		07.09	PR: 1KJ			
	1.6	75		07.09	PR: 1KJ			
	1.6 MultiFuel	75		07.09	PR: 1KJ			
	1.6 TDI	77		07.09	PR: 1KJ			
	1.6 TDI 4motion	77		07.09	PR: 1KJ			
	2.0	147		07.09	PR: 1KJ			
	2.0 TDI			07.09	PR: 1KJ			
<b>VOLKSWAGEN GOLF VI Convertible (11-)</b>								
	1.2 TSI	77		06.11	PR: 1ZE,1ZD,1ZP,1ZA,1ZB	G1020680		23587 20,6 +/WI ATE
	1.4 TSI	90		06.11	PR: 1ZE,1ZD,1ZP,1ZA,1ZB			
	1.4 TSI	118		06.11	PR: 1ZE,1ZD,1ZP,1ZA,1ZB			
	1.6 TDI	77		06.11	PR: 1ZE,1ZD,1ZP,1ZA,1ZB			
	2.0 R	195		01.13	PR: 1ZE,1ZD,1ZP,1ZA,1ZB			
	2.0 TDI	103		06.11	PR: 1ZE,1ZD,1ZP,1ZA,1ZB			
	2.0 TSI	155		06.11	PR: 1ZE,1ZD,1ZP,1ZA,1ZB			
	1.2 TSI	77		06.11	PR: 1ZK	G1020895		23801 20,3 +/WI ATE
	1.4 TSI	90		06.11	PR: 1ZK			
	1.4 TSI	118		06.11	PR: 1ZK			
	1.6 TDI	77		06.11	PR: 1ZK			
	2.0 R	195		01.13	PR: 1ZK			
	2.0 TDI	103		06.11	PR: 1ZK			
	2.0 TSI	155		06.11	PR: 1ZK			
	1.2 TSI	77		06.11	PR: 1ZE,1ZP	G2125145		288 25,0 22,0 V L +S +C
	1.4 TSI	90		06.11	PR: 1ZE,1ZP			
	1.4 TSI	118		06.11	PR: 1ZE,1ZP			
	1.6 TDI	77		06.11	PR: 1ZE,1ZP			
	2.0 R	195		01.13	PR: 1ZE,1ZP			
	2.0 TDI	103		06.11	PR: 1ZE,1ZP			
	2.0 TSI	155		06.11	PR: 1ZE,1ZP			
	1.2 TSI	77		06.11	PR: 1ZA,1ZD,1ZB	G2125158		312 25,0 22,0 V L +S +C
	1.4 TSI	90		06.11	PR: 1ZA,1ZD,1ZB			
	1.4 TSI	118		06.11	PR: 1ZA,1ZD,1ZB			
	1.6 TDI	77		06.11	PR: 1ZA,1ZD,1ZB			
	2.0 R	195		01.13	PR: 1ZA,1ZD,1ZB			
	2.0 TDI	103		06.11	PR: 1ZA,1ZD,1ZB			
	2.0 TSI	155		06.11	PR: 1ZA,1ZD,1ZB			
	1.2 TSI	77		06.11	PR: 1ZK	G2130115		345 30,0 27,0 V L +C
	1.4 TSI	90		06.11	PR: 1ZK			
	1.4 TSI	118		06.11	PR: 1ZK			
	1.6 TDI	77		06.11	PR: 1ZK			
	2.0 R	195		01.13	PR: 1ZK			
	2.0 TDI	103		06.11	PR: 1ZK			
	2.0 TSI	155		06.11	PR: 1ZK			
	1.2 TSI	77		06.11	PR: 1KD	G1020492		23554 17,1 /WD/S LUC
	1.4 TSI	90		06.11	PR: 1KD			
	1.4 TSI	118		06.11	PR: 1KD			
	1.6 TDI	77		06.11	PR: 1KD			
	2.0 R	195		01.13	PR: 1KD			
	2.0 TDI	103		06.11	PR: 1KD			
	2.0 TSI	155		06.11	PR: 1KD			
	1.2 TSI	77		06.11	PR: 1KW	G1020682		23914 17,1 /WD/Acc/S LUC
	1.4 TSI	90		06.11	PR: 1KW			
	1.4 TSI	118		06.11	PR: 1KW			
	1.6 TDI	77		06.11	PR: 1KW			
	2.0 R	195		01.13	PR: 1KW			
	2.0 TDI	103		06.11	PR: 1KW			
	2.0 TSI	155		06.11	PR: 1KW			
	1.2 TSI	77		06.11	PR: 1KS,1KT	G2110356		272 9,7 8,0 +S +C
	1.4 TSI	90		06.11	PR: 1KS,1KT			
	1.4 TSI	118		06.11	PR: 1KS,1KT			
	1.6 TDI	77		06.11	PR: 1KS,1KT			
	2.0 R	195		01.13	PR: 1KS,1KT			
	2.0 TDI	103		06.11	PR: 1KS,1KT			
	2.0 TSI	155		06.11	PR: 1KS,1KT			
	1.2 TSI	77		06.11	PR: 1KD	G2110277		253 10,0 8,0 +S +C
	1.4 TSI	90		06.11	PR: 1KD			
	1.4 TSI	118		06.11	PR: 1KD			
	1.6 TDI	77		06.11	PR: 1KD			
	2.0 R	195		01.13	PR: 1KD			
	2.0 TDI	103		06.11	PR: 1KD			
	2.0 TSI	155		06.11	PR: 1KD			
<b>VOLKSWAGEN GOLF VII (12-)</b>								
	1.2 TSI	63		11.12	PR: 1ZE,1ZP	G2125145		288 25,0 22,0 V L +S +C
	1.2 TSI	77		11.12	PR: 1ZE,1ZP			
	1.4 TSI	90		11.12	PR: 1ZE,1ZP			
	1.4 TSI	103		11.12	PR: 1ZE,1ZP			
	1.6 TDI	66		04.13	PR: 1ZE,1ZP			
	1.6 TDI	77		11.12	PR: 1ZE,1ZP			
	1.6 TDI	81		06.13	PR: 1ZE,1ZP			
	1.6 TDI 4motion	77		11.12	PR: 1ZE,1ZP			
	1.6 TDI 4motion	81		01.13	PR: 1ZE,1ZP			
	2.0 GTD	135		03.13	PR: 1ZE,1ZP			



**VOLKSWAGEN GOLF VII (12-)**

	2.0 GTI	162		03.13	PR: 1ZE,1ZP	<b>G2125145</b>		288 25,0 22,0 V L +S +C
	2.0 GTI Performance	169		03.13	PR: 1ZE,1ZP			
	2.0 R 4motion	221		09.13	PR: 1ZE,1ZP			
	2.0 TDI	81		11.12	PR: 1ZE,1ZP			
	2.0 TDI	105		08.12	PR: 1ZE,1ZP			
	2.0 TDI	110		11.12	PR: 1ZE,1ZP			
	2.0 TDI 4motion	110		11.12	PR: 1ZE,1ZP			
	1.2 TSI	63		11.12	PR: 1ZA,1ZB,1ZD,1LV	<b>G2125158</b>	312 25,0 22,0 V L +S +C	
	1.2 TSI	77		11.12	PR: 1ZA,1ZB,1ZD,1LV			
	1.4 TSI	90		11.12	PR: 1ZA,1ZB,1ZD,1LV			
	1.4 TSI	103		11.12	PR: 1ZA,1ZB,1ZD,1LV			
	1.6 TDI	66		04.13	PR: 1ZA,1ZB,1ZD,1LV			
	1.6 TDI	77		11.12	PR: 1ZA,1ZB,1ZD,1LV			
	1.6 TDI	81		06.13	PR: 1ZA,1ZB,1ZD,1LV			
	1.6 TDI 4motion	77		11.12	PR: 1ZA,1ZB,1ZD,1LV			
	1.6 TDI 4motion	81		01.13	PR: 1ZA,1ZB,1ZD,1LV			
	2.0 GTD	135		03.13	PR: 1ZA,1ZB,1ZD,1LV			
	2.0 GTI	162		03.13	PR: 1ZA,1ZB,1ZD,1LV			
	2.0 GTI Performance	169		03.13	PR: 1ZA,1ZB,1ZD,1LV			
	2.0 R 4motion	221		09.13	PR: 1ZA,1ZB,1ZD,1LV			
2.0 TDI	81		11.12	PR: 1ZA,1ZB,1ZD,1LV				
2.0 TDI	105		08.12	PR: 1ZA,1ZB,1ZD,1LV				
2.0 TDI	110		11.12	PR: 1ZA,1ZB,1ZD,1LV				
2.0 TDI 4motion	110		11.12	PR: 1ZA,1ZB,1ZD,1LV				
	1.2 TSI	63		11.12	PR: 1KE	<b>G2110356</b>	electric parking brake <sup>1)</sup>	272 9,7 8,0 +S +C
	1.2 TSI	77		11.12	PR: 1KE			
	1.4 TSI	90		11.12	PR: 1KE			
	1.4 TSI	103		11.12	PR: 1KE			
	1.6 TDI	66		04.13	PR: 1KE			
	1.6 TDI	77		11.12	PR: 1KE			
	1.6 TDI	81		06.13	PR: 1KE			
	1.6 TDI 4motion	77		11.12	PR: 1KE			
	1.6 TDI 4motion	81		01.13	PR: 1KE			
	2.0 GTD	135		03.13	PR: 1KE			
	2.0 GTI	162		03.13	PR: 1KE			
	2.0 GTI Performance	169		03.13	PR: 1KE			
	2.0 R 4motion	221		09.13	PR: 1KE			
	2.0 TDI	81		11.12	PR: 1KE			
2.0 TDI	105		08.12	PR: 1KE				
2.0 TDI	110		11.12	PR: 1KE				
2.0 TDI 4motion	110		11.12	PR: 1KE				

**VOLKSWAGEN GOLF VII Variant (13-)**

	1.2 TSI	63		07.13	PR: 1ZE,1ZP	<b>G2125145</b>		288 25,0 22,0 V L +S +C
	1.2 TSI	77		07.13	PR: 1ZE,1ZP			
	1.4 TSI	90		07.13	PR: 1ZE,1ZP			
	1.4 TSI	103		07.13	PR: 1ZE,1ZP			
	1.4 TSI BiFuel	81		09.13	PR: 1ZE,1ZP			
	1.4 TSI CNG	81		09.13	PR: 1ZE,1ZP			
	1.6 TDI	66		07.13	PR: 1ZE,1ZP			
	1.6 TDI	77		07.13	PR: 1ZE,1ZP			
	1.6 TDI	81		07.13	PR: 1ZE,1ZP			
	1.6 TDI 4motion	77		07.13	PR: 1ZE,1ZP			
	2.0 GTD	135		07.13	PR: 1ZE,1ZP			
	2.0 TDI	81		07.13	PR: 1ZE,1ZP			
	2.0 TDI	110		07.13	PR: 1ZE,1ZP			
	2.0 TDI 4motion	110		07.13	PR: 1ZE,1ZP			
	1.2 TSI	63		07.13	PR: 1ZA,1ZD	<b>G2125158</b>		312 25,0 22,0 V L +S +C
	1.2 TSI	77		07.13	PR: 1ZA,1ZD			
	1.4 TSI	90		07.13	PR: 1ZA,1ZD			
	1.4 TSI	103		07.13	PR: 1ZA,1ZD			
	1.4 TSI BiFuel	81		09.13	PR: 1ZA,1ZD			
	1.4 TSI CNG	81		09.13	PR: 1ZA,1ZD			
	1.6 TDI	66		07.13	PR: 1ZA,1ZD			
	1.6 TDI	77		07.13	PR: 1ZA,1ZD			
	1.6 TDI	81		07.13	PR: 1ZA,1ZD			
	1.6 TDI 4motion	77		07.13	PR: 1ZA,1ZD			
	2.0 GTD	135		07.13	PR: 1ZA,1ZD			
	2.0 TDI	81		07.13	PR: 1ZA,1ZD			
	2.0 TDI	110		07.13	PR: 1ZA,1ZD			
	2.0 TDI 4motion	110		07.13	PR: 1ZA,1ZD			
	1.2 TSI	63		07.13	PR: 1KE	<b>G2110356</b>	electric parking brake <sup>1)</sup>	272 9,7 8,0 +S +C
	1.2 TSI	77		07.13	PR: 1KE			
	1.4 TSI	90		07.13	PR: 1KE			
	1.4 TSI	103		07.13	PR: 1KE			
	1.4 TSI BiFuel	81		09.13	PR: 1KE			
	1.4 TSI CNG	81		09.13	PR: 1KE			
	1.6 TDI	66		07.13	PR: 1KE			
	1.6 TDI	77		07.13	PR: 1KE			
	1.6 TDI	81		07.13	PR: 1KE			
	1.6 TDI 4motion	77		07.13	PR: 1KE			
	2.0 GTD	135		07.13	PR: 1KE			
	2.0 TDI	81		07.13	PR: 1KE			
	2.0 TDI	110		07.13	PR: 1KE			
	2.0 TDI 4motion	110		07.13	PR: 1KE			

<sup>1)</sup> fr.di stazionamento elettrico / frein à main électrique / freno de mano eléctrico / elektrische Feststellbremse



**VOLKSWAGEN GOLF Plus (05-)**

	1.2 TSI		08.09	PR: 1ZF,1ZM	G1020463	23131 19,7 +/Wl	VW
	1.4 16V		01.05	PR: 1ZF,1ZM			
	1.4 FSI	66	07.05	PR: 1ZF,1ZM			
	1.4 TSI	90	06.07	PR: 1ZF,1ZM			
	1.4 TSI	103	05.06	PR: 1ZF,1ZM			
	1.4 TSI	118	06.08	PR: 1ZF,1ZM			
	1.4 TSI	125	05.06	PR: 1ZF,1ZM			
	1.6	75	05.05	PR: 1ZF,1ZM			
	1.6 BiFuel	75	05.09	PR: 1ZF,1ZM			
	1.6 FSI	85	01.05	PR: 1ZF,1ZM			
	1.6 TDI		02.09	PR: 1ZF,1ZM			
	1.9 TDI	66	05.05	PR: 1ZF,1ZM			
	1.9 TDI	77	01.05	PR: 1ZF,1ZM			
	2.0 FSI	110	05.05	PR: 1ZF,1ZM			
2.0 TDI	81	01.09	PR: 1ZF,1ZM				
2.0 TDI	103	01.05	PR: 1ZF,1ZM				
	1.2 TSI		08.09	PR: 1ZA,1ZP,1ZE,1LJ	G1020680	23587 20,6 +/Wl	ATE
	1.4 16V		01.05	PR: 1ZA,1ZP,1ZE,1LJ			
	1.4 FSI	66	07.05	PR: 1ZA,1ZP,1ZE,1LJ			
	1.4 TSI	90	06.07	PR: 1ZA,1ZP,1ZE,1LJ			
	1.4 TSI	103	05.06	PR: 1ZA,1ZP,1ZE,1LJ			
	1.4 TSI	118	06.08	PR: 1ZA,1ZP,1ZE,1LJ			
	1.4 TSI	125	05.06	PR: 1ZA,1ZP,1ZE,1LJ			
	1.6	75	05.05	PR: 1ZA,1ZP,1ZE,1LJ			
	1.6 BiFuel	75	05.09	PR: 1ZA,1ZP,1ZE,1LJ			
	1.6 FSI	85	01.05	PR: 1ZA,1ZP,1ZE,1LJ			
	1.6 TDI		02.09	PR: 1ZA,1ZP,1ZE,1LJ			
	1.9 TDI	66	05.05	PR: 1ZA,1ZP,1ZE,1LJ			
	1.9 TDI	77	01.05	PR: 1ZA,1ZP,1ZE,1LJ			
	2.0 FSI	110	05.05	PR: 1ZA,1ZP,1ZE,1LJ			
2.0 TDI	81	01.09	PR: 1ZA,1ZP,1ZE,1LJ				
2.0 TDI	103	01.05	PR: 1ZA,1ZP,1ZE,1LJ				
	1.2 TSI		08.09	PR: 1ZF,1ZM	G2122210	280 22,0 19,0 V L +S +C	
	1.4 16V		01.05	PR: 1ZF,1ZM			
	1.4 FSI	66	07.05	PR: 1ZF,1ZM			
	1.4 TSI	90	06.07	PR: 1ZF,1ZM			
	1.4 TSI	103	05.06	PR: 1ZF,1ZM			
	1.4 TSI	118	06.08	PR: 1ZF,1ZM			
	1.4 TSI	125	05.06	PR: 1ZF,1ZM			
	1.6	75	05.05	PR: 1ZF,1ZM			
	1.6 BiFuel	75	05.09	PR: 1ZF,1ZM			
	1.6 FSI	85	01.05	PR: 1ZF,1ZM			
	1.6 TDI		02.09	PR: 1ZF,1ZM			
	1.9 TDI	66	05.05	PR: 1ZF,1ZM			
	1.9 TDI	77	01.05	PR: 1ZF,1ZM			
	2.0 FSI	110	05.05	PR: 1ZF,1ZM			
2.0 TDI	81	01.09	PR: 1ZF,1ZM				
2.0 TDI	103	01.05	PR: 1ZF,1ZM				
	1.2 TSI		08.09	PR: 1ZE,1ZP	G2125145	288 25,0 22,0 V L +S +C	
	1.4 16V		01.05	PR: 1ZE,1ZP			
	1.4 FSI	66	07.05	PR: 1ZE,1ZP			
	1.4 TSI	90	06.07	PR: 1ZE,1ZP			
	1.4 TSI	103	05.06	PR: 1ZE,1ZP			
	1.4 TSI	118	06.08	PR: 1ZE,1ZP			
	1.4 TSI	125	05.06	PR: 1ZE,1ZP			
	1.6	75	05.05	PR: 1ZE,1ZP			
	1.6 BiFuel	75	05.09	PR: 1ZE,1ZP			
	1.6 FSI	85	01.05	PR: 1ZE,1ZP			
	1.6 TDI		02.09	PR: 1ZE,1ZP			
	1.9 TDI	66	05.05	PR: 1ZE,1ZP			
	1.9 TDI	77	01.05	PR: 1ZE,1ZP			
	2.0 FSI	110	05.05	PR: 1ZE,1ZP			
2.0 TDI	81	01.09	PR: 1ZE,1ZP				
2.0 TDI	103	01.05	PR: 1ZE,1ZP				
	1.2 TSI		08.09	PR: 1LJ,1ZA	G2125158	312 25,0 22,0 V L +S +C	
	1.4 16V		01.05	PR: 1LJ,1ZA			
	1.4 FSI	66	07.05	PR: 1LJ,1ZA			
	1.4 TSI	90	06.07	PR: 1LJ,1ZA			
	1.4 TSI	103	05.06	PR: 1LJ,1ZA			
	1.4 TSI	118	06.08	PR: 1LJ,1ZA			
	1.4 TSI	125	05.06	PR: 1LJ,1ZA			
	1.6	75	05.05	PR: 1LJ,1ZA			
	1.6 BiFuel	75	05.09	PR: 1LJ,1ZA			
	1.6 FSI	85	01.05	PR: 1LJ,1ZA			
	1.6 TDI		02.09	PR: 1LJ,1ZA			
	1.9 TDI	66	05.05	PR: 1LJ,1ZA			
	1.9 TDI	77	01.05	PR: 1LJ,1ZA			
	2.0 FSI	110	05.05	PR: 1LJ,1ZA			
2.0 TDI	81	01.09	PR: 1LJ,1ZA				
2.0 TDI	103	01.05	PR: 1LJ,1ZA				





**VOLKSWAGEN GOLF Plus (05-)**

	1.4 16V		01.05	PR: 1KD	G1020492	23554 17,1 /WD/S	LUC
	1.4 FSI	66	07.05	PR: 1KD			
	1.4 TSI	90	06.07	PR: 1KD			
	1.4 TSI	103	05.06	PR: 1KD			
	1.4 TSI	118	06.08	PR: 1KD			
	1.4 TSI	125	05.06	PR: 1KD			
	1.6	75	05.05	PR: 1KD			
	1.6 BiFuel	75	05.09	PR: 1KD			
	1.6 BiFuel	75	05.09	PR: 1KD			
	1.6 FSI	85	01.05	PR: 1KD			
	1.6 TDI		02.09	PR: 1KD			
	1.6 TDI		02.09	PR: 1KD			
	1.9 TDI	66	05.05	PR: 1KD			
	1.9 TDI	77	01.05	PR: 1KD			
	2.0 FSI	110	05.05	PR: 1KD			
2.0 TDI		05.05	PR: 1KD				
2.0 TDI	81	01.09	PR: 1KD				
2.0 TDI	103	01.05	PR: 1KD				
	1.2 TSI		08.09	PR: 1KE,1KZ	G1020682	23914 17,1 /WD/Acc/S	LUC
	1.4 16V		01.05	PR: 1KE,1KZ			
	1.4 FSI	66	07.05	PR: 1KE,1KZ			
	1.4 TSI	90	06.07	PR: 1KE,1KZ			
	1.4 TSI	103	05.06	PR: 1KE,1KZ			
	1.4 TSI	118	06.08	PR: 1KE,1KZ			
	1.4 TSI	125	05.06	PR: 1KE,1KZ			
	1.6	75	05.05	PR: 1KE,1KZ			
	1.6 BiFuel	75	05.09	PR: 1KE,1KZ			
	1.6 FSI	85	01.05	PR: 1KE,1KZ			
	1.6 TDI		02.09	PR: 1KE,1KZ			
	1.9 TDI	66	05.05	PR: 1KE,1KZ			
	1.9 TDI	77	01.05	PR: 1KE,1KZ			
	2.0 FSI	110	05.05	PR: 1KE,1KZ			
	2.0 TDI		05.05	PR: 1KE,1KZ			
2.0 TDI	81	01.09	PR: 1KE,1KZ				
2.0 TDI	103	01.05	PR: 1KE,1KZ				
	1.2 TSI		08.09	PR: 1KD	G2110277	253 10,0 8,0 +S +C	
	1.4 16V		01.05	PR: 1KD			
	1.4 FSI	66	07.05	PR: 1KD			
	1.4 TSI	90	06.07	PR: 1KD			
	1.4 TSI	103	05.06	PR: 1KD			
	1.4 TSI	118	06.08	PR: 1KD			
	1.4 TSI	125	05.06	PR: 1KD			
	1.6	75	05.05	PR: 1KD			
	1.6 BiFuel	75	05.09	PR: 1KD			
	1.6 FSI	85	01.05	PR: 1KD			
	1.6 TDI		02.09	PR: 1KD			
	1.9 TDI	66	05.05	PR: 1KD			
	1.9 TDI	77	01.05	PR: 1KD			
	2.0 FSI	110	05.05	PR: 1KD			
	2.0 TDI		05.05	PR: 1KD			
2.0 TDI	81	01.09	PR: 1KD				
2.0 TDI	103	01.05	PR: 1KD				
	1.2 TSI		08.09	PR: 1KE	G2112158	256 12,0 10,0 +C	
	1.4 16V		01.05	PR: 1KE			
	1.4 FSI	66	07.05	PR: 1KE			
	1.4 TSI	90	06.07	PR: 1KE			
	1.4 TSI	103	05.06	PR: 1KE			
	1.4 TSI	118	06.08	PR: 1KE			
	1.4 TSI	125	05.06	PR: 1KE			
	1.6	75	05.05	PR: 1KE			
	1.6 BiFuel	75	05.09	PR: 1KE			
	1.6 FSI	85	01.05	PR: 1KE			
	1.6 TDI		02.09	PR: 1KE			
	1.9 TDI	66	05.05	PR: 1KE			
	1.9 TDI	77	01.05	PR: 1KE			
	2.0 FSI	110	05.05	PR: 1KE			
	2.0 TDI		05.05	PR: 1KE			
2.0 TDI	81	01.09	PR: 1KE				
2.0 TDI	103	01.05	PR: 1KE				
	1.2 TSI		08.09	PR: 1KZ	G2112169	282 12,0 10,0 +S +C	
	1.4 16V		01.05	PR: 1KZ			
	1.4 FSI	66	07.05	PR: 1KZ			
	1.4 TSI	90	06.07	PR: 1KZ			
	1.4 TSI	103	05.06	PR: 1KZ			
	1.4 TSI	118	06.08	PR: 1KZ			
	1.4 TSI	125	05.06	PR: 1KZ			
	1.6	75	05.05	PR: 1KZ			
	1.6 BiFuel	75	05.09	PR: 1KZ			
	1.6 FSI	85	01.05	PR: 1KZ			
	1.6 TDI		02.09	PR: 1KZ			
	1.9 TDI	66	05.05	PR: 1KZ			
	1.9 TDI	77	01.05	PR: 1KZ			
	2.0 FSI	110	05.05	PR: 1KZ			
	2.0 TDI		05.05	PR: 1KZ			
2.0 TDI	81	01.09	PR: 1KZ				
2.0 TDI	103	01.05	PR: 1KZ				



**VOLKSWAGEN JETTA V (05-10)**

	1.4 TSI	90	05.07	10.10	PR: 12M	G1020463	23131 19,7 +/WI	VW
	1.4 TSI	103	06.06	10.10	PR: 12M			
	1.4 TSI	118	07.08	10.10	PR: 12M			
	1.4 TSI	125	06.06	10.10	PR: 12M			
	1.6 FSI	85	08.05	10.10	PR: 12M			
	1.6 i 16V	75	08.05	10.10	PR: 12M			
	1.6 TDI	77	06.09	10.10	PR: 12M			
	1.9 TDI	77	08.05	10.10	PR: 12M			
	2.0 FSI	110	08.05	10.10	PR: 12M			
	2.0 TDI	100	09.05	10.10	PR: 12M			
	2.0 TDI	103	08.05	10.10	PR: 12M			
	2.0 TDI	125	06.06	10.10	PR: 12M			
	2.0 TFSI		10.05	10.10	PR: 12M			
	2.5 FSI		07.08	10.10	PR: 12M			
		1.4 TSI	90	05.07	10.10			
1.4 TSI		103	06.06	10.10	PR: 1ZE,1ZP,1ZD,1LJ			
1.4 TSI		118	07.08	10.10	PR: 1ZE,1ZP,1ZD,1LJ			
1.4 TSI		125	06.06	10.10	PR: 1ZE,1ZP,1ZD,1LJ			
1.6 FSI		85	08.05	10.10	PR: 1ZE,1ZP,1ZD,1LJ			
1.6 i 16V		75	08.05	10.10	PR: 1ZE,1ZP,1ZD,1LJ			
1.6 TDI		77	06.09	10.10	PR: 1ZE,1ZP,1ZD,1LJ			
1.9 TDI		77	08.05	10.10	PR: 1ZE,1ZP,1ZD,1LJ			
2.0 FSI		110	08.05	10.10	PR: 1ZE,1ZP,1ZD,1LJ			
2.0 TDI		100	09.05	10.10	PR: 1ZE,1ZP,1ZD,1LJ			
2.0 TDI		103	08.05	10.10	PR: 1ZE,1ZP,1ZD,1LJ			
2.0 TDI		125	06.06	10.10	PR: 1ZE,1ZP,1ZD,1LJ			
2.0 TFSI			10.05	10.10	PR: 1ZE,1ZP,1ZD,1LJ			
2.5 FSI			07.08	10.10	PR: 1ZE,1ZP,1ZD,1LJ			
		1.4 TSI	90	05.07	10.10	PR: 12M	G2122210	280 22,0 19,0 V L +S +C
	1.4 TSI	103	06.06	10.10	PR: 12M			
	1.4 TSI	118	07.08	10.10	PR: 12M			
	1.4 TSI	125	06.06	10.10	PR: 12M			
	1.6 FSI	85	08.05	10.10	PR: 12M			
	1.6 i 16V	75	08.05	10.10	PR: 12M			
	1.6 TDI	77	06.09	10.10	PR: 12M			
	1.9 TDI	77	08.05	10.10	PR: 12M			
	2.0 FSI	110	08.05	10.10	PR: 12M			
	2.0 TDI	100	09.05	10.10	PR: 12M			
	2.0 TDI	103	08.05	10.10	PR: 12M			
	2.0 TDI	125	06.06	10.10	PR: 12M			
	2.0 TFSI		10.05	10.10	PR: 12M			
	2.5 FSI		07.08	10.10	PR: 12M			
		1.4 TSI	90	05.07	10.10	PR: 1ZE,1ZP		
1.4 TSI		103	06.06	10.10	PR: 1ZE,1ZP			
1.4 TSI		118	07.08	10.10	PR: 1ZE,1ZP			
1.4 TSI		125	06.06	10.10	PR: 1ZE,1ZP			
1.6 FSI		85	08.05	10.10	PR: 1ZE,1ZP			
1.6 i 16V		75	08.05	10.10	PR: 1ZE,1ZP			
1.6 TDI		77	06.09	10.10	PR: 1ZE,1ZP			
1.9 TDI		77	08.05	10.10	PR: 1ZE,1ZP			
2.0 FSI		110	08.05	10.10	PR: 1ZE,1ZP			
2.0 TDI		100	09.05	10.10	PR: 1ZE,1ZP			
2.0 TDI		103	08.05	10.10	PR: 1ZE,1ZP			
2.0 TDI		125	06.06	10.10	PR: 1ZE,1ZP			
2.0 TFSI			10.05	10.10	PR: 1ZE,1ZP			
2.5 FSI			07.08	10.10	PR: 1ZE,1ZP			
		1.4 TSI	90	05.07	10.10	PR: 1LJ,1ZD	G2125158	312 25,0 22,0 V L +S +C
	1.4 TSI	103	06.06	10.10	PR: 1LJ,1ZD			
	1.4 TSI	118	07.08	10.10	PR: 1LJ,1ZD			
	1.4 TSI	125	06.06	10.10	PR: 1LJ,1ZD			
	1.6 FSI	85	08.05	10.10	PR: 1LJ,1ZD			
	1.6 i 16V	75	08.05	10.10	PR: 1LJ,1ZD			
	1.6 TDI	77	06.09	10.10	PR: 1LJ,1ZD			
	1.9 TDI	77	08.05	10.10	PR: 1LJ,1ZD			
	2.0 FSI	110	08.05	10.10	PR: 1LJ,1ZD			
	2.0 TDI	100	09.05	10.10	PR: 1LJ,1ZD			
	2.0 TDI	103	08.05	10.10	PR: 1LJ,1ZD			
	2.0 TDI	125	06.06	10.10	PR: 1LJ,1ZD			
	2.0 TFSI		10.05	10.10	PR: 1LJ,1ZD			
	2.5 FSI		07.08	10.10	PR: 1LJ,1ZD			
		1.4 TSI	90	05.07	10.10	PR: 1KE,1KF,1KJ,1KV		
1.4 TSI		103	06.06	10.10	PR: 1KE,1KF,1KJ,1KV			
1.4 TSI		118	07.08	10.10	PR: 1KE,1KF,1KJ,1KV			
1.4 TSI		125	06.06	10.10	PR: 1KE,1KF,1KJ,1KV			
1.6 FSI		85	08.05	10.10	PR: 1KE,1KF,1KJ,1KV			
1.6 i 16V		75	08.05	10.10	PR: 1KE,1KF,1KJ,1KV			
1.6 TDI		77	06.09	10.10	PR: 1KE,1KF,1KJ,1KV			
1.9 TDI		77	08.05	10.10	PR: 1KE,1KF,1KJ,1KV			
2.0 FSI		110	08.05	10.10	PR: 1KE,1KF,1KJ,1KV			
2.0 TDI		100	09.05	10.10	PR: 1KE,1KF,1KJ,1KV			
2.0 TDI		103	08.05	10.10	PR: 1KE,1KF,1KJ,1KV			
2.0 TDI		125	06.06	10.10	PR: 1KE,1KF,1KJ,1KV			
2.0 TFSI			10.05	10.10	PR: 1KE,1KF,1KJ,1KV			
2.5 FSI			07.08	10.10	PR: 1KE,1KF,1KJ,1KV			























**VOLKSWAGEN JETTA V (05-10)**

	1.4 TSI	90		05.07	10.10	PR: 1KE,1KF	<b>G2112158</b>		256 12,0 10,0 +C			
	1.4 TSI	103		06.06	10.10	PR: 1KE,1KF						
	1.4 TSI	118		07.08	10.10	PR: 1KE,1KF						
	1.4 TSI	125		06.06	10.10	PR: 1KE,1KF						
	1.6 FSI	85		08.05	10.10	PR: 1KE,1KF						
	1.6 i 16V	75		08.05	10.10	PR: 1KE,1KF						
	1.6 TDI			06.09	10.10	PR: 1KE,1KF						
	1.9 TDI	77		08.05	10.10	PR: 1KE,1KF						
	2.0 FSI	110		08.05	10.10	PR: 1KE,1KF						
	2.0 TDI	100		09.05	10.10	PR: 1KE,1KF						
	2.0 TDI	103		08.05	10.10	PR: 1KE,1KF						
	2.0 TDI	125		06.06	10.10	PR: 1KE,1KF						
	2.0 TFSI			10.05	10.10	PR: 1KE,1KF						
	2.5 FSI			07.08	10.10	PR: 1KE,1KF						
	1.4 TSI	90		05.07	10.10	PR: 1KJ,1KV				<b>G2112169</b>		282 12,0 10,0 +S +C
	1.4 TSI	103		06.06	10.10	PR: 1KJ,1KV						
	1.4 TSI	118		07.08	10.10	PR: 1KJ,1KV						
	1.4 TSI	125		06.06	10.10	PR: 1KJ,1KV						
	1.6 FSI	85		08.05	10.10	PR: 1KJ,1KV						
	1.6 i 16V	75		08.05	10.10	PR: 1KJ,1KV						
1.6 TDI			06.09	10.10	PR: 1KJ,1KV							
1.9 TDI	77		08.05	10.10	PR: 1KJ,1KV							
2.0 FSI	110		08.05	10.10	PR: 1KJ,1KV							
2.0 TDI	100		09.05	10.10	PR: 1KJ,1KV							
2.0 TDI	103		08.05	10.10	PR: 1KJ,1KV							
2.0 TDI	125		06.06	10.10	PR: 1KJ,1KV							
2.0 TFSI			10.05	10.10	PR: 1KJ,1KV							
2.5 FSI			07.08	10.10	PR: 1KJ,1KV							

**VOLKSWAGEN JETTA VI (11-)**

	1.2 TSI	77		04.11		PR: 1ZM	<b>G1020463</b>		23131 19,7 +/WI	<b>VW</b>				
	1.4 TSI			04.11		PR: 1ZM								
	1.4 TSI	90		04.11		PR: 1ZM								
	1.4 TSI Hybrid	110		04.11		PR: 1ZM								
	1.6	77		12.11		PR: 1ZM								
	1.6 TDI	77		04.11		PR: 1ZM								
	2.0 TDI	103		04.11		PR: 1ZM								
	2.0 TSI	147		04.11		PR: 1ZM								
	2.0 TSI	155		12.12		PR: 1ZM								
	1.2 TSI	77		04.11		PR: 1ZQ					<b>G1020331</b>		23130 19,7 +	<b>VW</b>
	1.4 TSI			04.11		PR: 1ZQ								
	1.4 TSI	90		04.11		PR: 1ZQ								
	1.4 TSI Hybrid	110		04.11		PR: 1ZQ								
	1.6	77		12.11		PR: 1ZQ								
1.6 TDI	77		04.11		PR: 1ZQ									
2.0 TDI	103		04.11		PR: 1ZQ									
2.0 TSI	147		04.11		PR: 1ZQ									
2.0 TSI	155		12.12		PR: 1ZQ									
1.2 TSI	77		04.11		PR: 1ZA,1ZB,1ZE	<b>G1020680</b>		23587 20,6 +/WI	<b>ATE</b>					
1.4 TSI			04.11		PR: 1ZA,1ZB,1ZE									
1.4 TSI	90		04.11		PR: 1ZA,1ZB,1ZE									
1.4 TSI Hybrid	110		04.11		PR: 1ZA,1ZB,1ZE									
1.6	77		12.11		PR: 1ZA,1ZB,1ZE									
1.6 TDI	77		04.11		PR: 1ZA,1ZB,1ZE									
2.0 TDI	103		04.11		PR: 1ZA,1ZB,1ZE									
2.0 TSI	147		04.11		PR: 1ZA,1ZB,1ZE									
2.0 TSI	155		12.12		PR: 1ZA,1ZB,1ZE									
	1.2 TSI	77		04.11						PR: 1ZM,1ZQ	<b>G2122210</b>		280 22,0 19,0 V L +S +C	
	1.4 TSI			04.11						PR: 1ZM,1ZQ				
	1.4 TSI	90		04.11						PR: 1ZM,1ZQ				
	1.4 TSI Hybrid	110		04.11						PR: 1ZM,1ZQ				
	1.6	77		12.11						PR: 1ZM,1ZQ				
	1.6 TDI	77		04.11		PR: 1ZM,1ZQ								
	2.0 TDI	103		04.11		PR: 1ZM,1ZQ								
	2.0 TSI	147		04.11		PR: 1ZM,1ZQ								
	2.0 TSI	155		12.12		PR: 1ZM,1ZQ								
	1.2 TSI	77		04.11		PR: 1ZE,1ZP	<b>G2125145</b>		288 25,0 22,0 V L +S +C					
	1.4 TSI			04.11		PR: 1ZE,1ZP								
	1.4 TSI	90		04.11		PR: 1ZE,1ZP								
	1.4 TSI Hybrid	110		04.11		PR: 1ZE,1ZP								
	1.6	77		12.11		PR: 1ZE,1ZP								
1.6 TDI	77		04.11		PR: 1ZE,1ZP									
2.0 TDI	103		04.11		PR: 1ZE,1ZP									
2.0 TSI	147		04.11		PR: 1ZE,1ZP									
2.0 TSI	155		12.12		PR: 1ZE,1ZP									
1.2 TSI	77		04.11		PR: 1ZA,1ZB,1LV	<b>G2125158</b>					312 25,0 22,0 V L +S +C			
1.4 TSI			04.11		PR: 1ZA,1ZB,1LV									
1.4 TSI	90		04.11		PR: 1ZA,1ZB,1LV									
1.4 TSI Hybrid	110		04.11		PR: 1ZA,1ZB,1LV									
1.6	77		12.11		PR: 1ZA,1ZB,1LV									
1.6 TDI	77		04.11		PR: 1ZA,1ZB,1LV									
2.0 TDI	103		04.11		PR: 1ZA,1ZB,1LV									
2.0 TSI	147		04.11		PR: 1ZA,1ZB,1LV									
2.0 TSI	155		12.12		PR: 1ZA,1ZB,1LV									

								
<b>VOLKSWAGEN JETTA VI (11-)</b>								
	1.2 TSI	77		04.11	PR: 1KD	G2110277	253 10,0 8,0 +S +C	
	1.4 TSI			04.11	PR: 1KD			
	1.4 TSI	90		04.11	PR: 1KD			
	1.4 TSI Hybrid	110		04.11	PR: 1KD			
	1.6	77		12.11	PR: 1KD			
	1.6 TDI	77		04.11	PR: 1KD			
	2.0 TDI	103		04.11	PR: 1KD			
	2.0 TSI	147		04.11	PR: 1KD			
	2.0 TSI	155		12.12	PR: 1KD			
	1.2 TSI	77		04.11	PR: 1KS,1KT	G2110356	272 9,7 8,0 +S +C	
	1.4 TSI			04.11	PR: 1KS,1KT			
	1.4 TSI	90		04.11	PR: 1KS,1KT			
	1.4 TSI Hybrid	110		04.11	PR: 1KS,1KT			
	1.6	77		12.11	PR: 1KS,1KT			
1.6 TDI	77		04.11	PR: 1KS,1KT				
2.0 TDI	103		04.11	PR: 1KS,1KT				
2.0 TSI	147		04.11	PR: 1KS,1KT				
2.0 TSI	155		12.12	PR: 1KS,1KT				
<b>VOLKSWAGEN LT/LT 4x4 (96-06)</b>								
	LT 28			05.96	07.06	G1020742	21576 20,7 +/WD	ATE
	LT 35			05.96	07.06			
	LT 46			05.96	07.06	G1020891	29153 20,0 /WD/Acc/S	PER
	LT 28			05.96	07.06	G2122161	276 22,0 19,0 V L +S +C	
	LT 35			05.96	07.06			
	LT 46			05.96	07.06			
	LT 28			05.96	07.06	G1020396	21621 17,3 +/WD	ATE
	LT 35		2D-X-002 119	05.96		G1020397	21592 18,8 +/WD	ATE
	LT 35		2D-X-002 120		07.06	G1020583	23021 18,9 /WD	BOS
	LT 46			05.96	07.06	G1020891	29153 20,0 /WD/Acc/S	PER
<b>VOLKSWAGEN LUPO (98-05)</b>								
	1.0			04.98	08.05	G1020408	21866 17,2 +	VW
	1.4	44		09.00	08.05			
	1.4 16V	55		10.98	08.05			
	1.4 16V	74		01.99	08.05			
	1.4 FSI	77		09.00	08.05			
	1.4 TDI	55		01.99	08.05			
	1.6 GTI	92		09.00	08.05			
	1.7 SDI			04.98	08.05			
	1.0			04.98	08.05	G1020444	21945 16,0 /S	LUC
	1.4	44		09.00	08.05			
	1.4 16V	55		10.98	08.05			
	1.4 16V	74		01.99	08.05			
	1.4 FSI	77		09.00	08.05			
	1.4 TDI	55		01.99	08.05			
1.6 GTI	92		09.00	08.05				
1.7 SDI			04.98	08.05				
	1.0			04.98	08.05	G2118106	239 18,0 16,0 V L +S +C	
	1.4	44		09.00	08.05			
	1.4 16V	55		10.98	08.05			
	1.4 16V	74		01.99	08.05			
	1.4 FSI	77		09.00	08.05			
	1.4 TDI	55		01.99	08.05			
	1.6 GTI	92		09.00	08.05			
	1.7 SDI			04.98	08.05			
	1.0			04.98	08.05	G2120128	256 20,0 18,0 V L +S +C	
	1.4	44		09.00	08.05			
	1.4 16V	55		10.98	08.05			
	1.4 16V	74		01.99	08.05			
	1.4 FSI	77		09.00	08.05			
	1.4 TDI	55		01.99	08.05			
1.6 GTI	92		09.00	08.05				
1.7 SDI			04.98	08.05				
	1.4 16V	74		01.99	08.05	G1020549	20961 17,1 /WD/S	LUC
	1.4 FSI	77		09.00	08.05	G1020566	23554 17,1 +/W/S	LUC
	1.6 GTI	92		09.00	08.05			
	1.4 16V	74		01.99	08.05	G2109124	232 9,0 7,0 +C	
	1.4 FSI	77		09.00	08.05			
	1.6 GTI	92		09.00	08.05			
<b>VOLKSWAGEN NEW BEETLE (98-10)</b>								
	1.9 TDI	66	9C-X-999000	01.98		G1020331	23130 19,7 +	VW
	2.0	85	9C-X-999000	01.98				
	1.4	55		08.01	05.10	G1020463	23131 19,7 +/W/I	VW
	1.6			11.99	05.10			
	1.8 T	110		10.99	05.10			
	1.8 T	132		11.01	06.05			
	1.9 TDI	66	9C-Y-600001	02.01				
	1.9 TDI	74		10.00	05.10			
	1.9 TDI	77		07.05	05.10			
	2.0	85	9C-Y-600001	05.10				
	1.9 TDI	66	9C-X-699000	01.98		G1020379	21911 20,3 +	ATE
	2.0	85	9C-X-699000	01.98				

































**VOLKSWAGEN NEW BEETLE (98-10)**

	1.4 1.6 1.8 T 1.8 T 1.9 TDI 1.9 TDI 1.9 TDI 2.0 2.3 V5 3.2 RSI	55 110 132 66 74 77 85 125	9C-Y-600001 9C-Y-600001	08.01 11.99 10.99 11.01 02.01 10.00 07.05 10.00 04.00	05.10 05.10 05.10 06.05 05.10 05.10 05.10 05.05 03.03	PR: 1ZD,1ZE PR: 1ZD,1ZE PR: 1ZD,1ZE PR: 1ZD,1ZE PR: 1ZD,1ZE PR: 1ZD,1ZE PR: 1ZD,1ZE PR: 1ZD,1ZE	G1020512		23392 20,3 +/WI	ATE
	1.4 1.6 1.8 T 1.8 T 1.9 TDI 1.9 TDI 1.9 TDI 2.0	55 110 132 66 74 77 85		08.01 11.99 10.99 11.01 01.98 10.00 07.05 01.98	05.10 05.10 05.10 06.05 02.01 05.10 05.10 05.10	PR: 1ZP,1ZM PR: 1ZP,1ZM PR: 1ZP,1ZM PR: 1ZP,1ZM PR: 1ZP,1ZM PR: 1ZP,1ZM PR: 1ZP,1ZM PR: 1ZP,1ZM	G2122150		280 22,0 19,0 V L +S +C	
	1.4 1.6 1.8 T 1.8 T 1.9 TDI 1.9 TDI 1.9 TDI 2.0	55 110 132 66 74 77 85		08.01 11.99 10.99 11.01 01.98 10.00 07.05 01.98	05.10 05.10 05.10 06.05 02.01 05.10 05.10 05.10	PR: 1ZD,1ZE PR: 1ZD,1ZE PR: 1ZD,1ZE PR: 1ZD,1ZE PR: 1ZD,1ZE PR: 1ZD,1ZE PR: 1ZD,1ZE PR: 1ZD,1ZE	G2125113		288 25,0 22,0 V L +S +C	
	2.3 V5 3.2 RSI	125		10.00 04.00	12.05 03.03		G2125123		310 25,0 22,0 V L +C	
	1.4 1.6 1.8 T 1.8 T 1.9 TDI 1.9 TDI 1.9 TDI 2.0 2.3 V5 3.2 RSI	55 110 132 66 74 77 85 125		08.01 11.99 10.99 11.01 01.98 10.00 07.05 01.98 10.00 04.00	05.10 05.10 05.10 06.05 02.01 05.10 05.10 05.10 05.05 03.03	PR: 1KS,1KV PR: 1KS,1KV PR: 1KS,1KV PR: 1KS,1KV PR: 1KS,1KV PR: 1KS,1KV PR: 1KS,1KV PR: 1KS,1KV PR: 1KY PR: 1KY	G1020755		20961 17,1 /Acc/S	LUC
	1.8 T 2.3 V5 3.2 RSI	132 125		11.01 10.00 04.00	06.05 05.05 03.03	PR: 1KY PR: 1KY	G1020676		20961 15,8 /S	LUC
	1.4 1.6 1.8 T 1.8 T 1.9 TDI 1.9 TDI 1.9 TDI 2.0	55 110 132 66 74 77 85		08.01 11.99 10.99 11.01 01.98 10.00 07.05 01.98	05.10 05.10 05.10 06.05 02.01 05.10 05.10 05.10	PR: 1KS,1KV PR: 1KS,1KV PR: 1KS,1KV PR: 1KS,1KV PR: 1KS,1KV PR: 1KS,1KV PR: 1KS,1KV PR: 1KS,1KV	G1020492		23554 17,1 /WD/S	LUC
	1.4 1.6 1.8 T 1.8 T 1.9 TDI 1.9 TDI 1.9 TDI 2.0	55 110 132 66 74 77 85		08.01 11.99 10.99 11.01 01.98 10.00 07.05 01.98	05.10 05.10 05.10 06.05 02.01 05.10 05.10 05.10	PR: 1KS,1KV PR: 1KS,1KV PR: 1KS,1KV PR: 1KS,1KV PR: 1KS,1KV PR: 1KS,1KV PR: 1KS,1KV PR: 1KS,1KV	G2109123		230 9,0 7,0 +S +C	
	1.8 T 2.3 V5 3.2 RSI	132 125		11.01 10.00 04.00	06.05 05.05 03.03	PR: 1KY PR: 1KY	G2122163		256 22,0 20,0 V L +C	

**VOLKSWAGEN NEW BEETLE Convertible (03-10)**

	1.4 1.6 1.8 T 1.9 TDI 1.9 TDI 2.0	55 75 110 74 77 85		01.03 01.03 12.03 07.03 07.05 01.03	05.10 05.10 05.10 05.10 05.10 05.10	PR: 1ZP,1ZM PR: 1ZP,1ZM PR: 1ZP,1ZM PR: 1ZP,1ZM PR: 1ZP,1ZM PR: 1ZP,1ZM	G1020463		23131 19,7 +/WI	VW
	1.4 1.6 1.8 T 1.9 TDI 1.9 TDI 2.0	55 75 110 74 77 85		01.03 01.03 12.03 07.03 07.05 01.03	05.10 05.10 05.10 05.10 05.10 05.10	PR: 1ZD,1ZE PR: 1ZD,1ZE PR: 1ZD,1ZE PR: 1ZD,1ZE PR: 1ZD,1ZE PR: 1ZD,1ZE	G1020512		23392 20,3 +/WI	ATE
	1.4 1.6 1.8 T 1.9 TDI 1.9 TDI 2.0	55 75 110 74 77 85		01.03 01.03 12.03 07.03 07.05 01.03	05.10 05.10 05.10 05.10 05.10 05.10	PR: 1ZP,1ZM PR: 1ZP,1ZM PR: 1ZP,1ZM PR: 1ZP,1ZM PR: 1ZP,1ZM PR: 1ZP,1ZM	G2122150		280 22,0 19,0 V L +S +C	
	1.4 1.6 1.8 T 1.9 TDI 1.9 TDI 2.0	55 75 110 74 77 85		01.03 01.03 12.03 07.03 07.05 01.03	05.10 05.10 05.10 05.10 05.10 05.10	PR: 1ZD,1ZE PR: 1ZD,1ZE PR: 1ZD,1ZE PR: 1ZD,1ZE PR: 1ZD,1ZE PR: 1ZD,1ZE	G2125113		288 25,0 22,0 V L +S +C	
	1.4 1.6 1.8 T 1.9 TDI 1.9 TDI 2.0	55 75 110 74 77 85		01.03 01.03 12.03 07.03 07.05 01.03	05.10 05.10 05.10 05.10 05.10 05.10	PR: 1KS,1KV PR: 1KS,1KV PR: 1KS,1KV PR: 1KS,1KV PR: 1KS,1KV PR: 1KS,1KV	G1020755		20961 17,1 /Acc/S	LUC

								
<b>VOLKSWAGEN NEW BEETLE Convertible (03-10)</b>								
	1.4 1.6 1.8 T 1.9 TDI 1.9 TDI 2.0	55 75 110 74 77 85	01.03 01.03 12.03 07.03 07.05 01.03	05.10 05.10 05.10 05.10 05.10 05.10	PR: 1KS,1KV PR: 1KS,1KV PR: 1KS,1KV PR: 1KS,1KV PR: 1KS,1KV PR: 1KS,1KV	G2109123		230 9,0 7,0 +S +C
<b>VOLKSWAGEN BEETLE (11-)</b>								
	1.2 TSI 1.4 TSI 1.6 TDI 2.0 TDI 2.0 TSI 2.0 TSI 2.5	77 118 77 103 147 155 125	07.11 04.11 10.11 04.11 04.11 05.13 04.11		PR: 1ZQ PR: 1ZQ PR: 1ZQ PR: 1ZQ PR: 1ZQ PR: 1ZQ PR: 1ZQ	G1020331		23130 19,7 + <b>VW</b>
	1.2 TSI 1.4 TSI 1.6 TDI 2.0 TDI 2.0 TSI 2.0 TSI 2.5	77 118 77 103 147 155 125	10.11 10.11 10.11 10.11 10.11 05.13 04.11		PR: 1ZA,1ZB,1ZE PR: 1ZA,1ZB,1ZE PR: 1ZA,1ZB,1ZE PR: 1ZA,1ZB,1ZE PR: 1ZA,1ZB,1ZE PR: 1ZA,1ZB,1ZE PR: 1ZA,1ZB,1ZE	G1020680		23587 20,6 +/Wl <b>ATE</b>
	1.2 TSI 1.4 TSI 1.6 TDI 2.0 TDI 2.0 TSI 2.0 TSI 2.5	77 118 77 103 147 155 125	07.11 04.11 10.11 04.11 04.11 05.13 04.11		PR: 1LV,1ZD,1ZM,1ZP PR: 1LV,1ZD,1ZM,1ZP PR: 1LV,1ZD,1ZM,1ZP PR: 1LV,1ZD,1ZM,1ZP PR: 1LV,1ZD,1ZM,1ZP PR: 1LV,1ZD,1ZM,1ZP PR: 1LV,1ZD,1ZM,1ZP	G1020463		23131 19,7 +/Wl <b>VW</b>
	1.2 TSI 1.4 TSI 1.6 TDI 2.0 TDI 2.0 TSI 2.0 TSI 2.5	77 118 77 103 147 155 125	07.11 04.11 10.11 04.11 04.11 05.13 04.11		PR: 1ZM,1ZQ PR: 1ZM,1ZQ PR: 1ZM,1ZQ PR: 1ZM,1ZQ PR: 1ZM,1ZQ PR: 1ZM,1ZQ PR: 1ZM,1ZQ	G2122210		280 22,0 19,0 V L +S +C
	1.2 TSI 1.4 TSI 1.6 TDI 2.0 TDI 2.0 TSI 2.0 TSI 2.5	77 118 77 103 147 155 125	07.11 04.11 10.11 04.11 04.11 05.13 04.11		PR: 1ZA,1ZB,1ZD,1LV PR: 1ZA,1ZB,1ZD,1LV PR: 1ZA,1ZB,1ZD,1LV PR: 1ZA,1ZB,1ZD,1LV PR: 1ZA,1ZB,1ZD,1LV PR: 1ZA,1ZB,1ZD,1LV PR: 1ZA,1ZB,1ZD,1LV	G2125158		312 25,0 22,0 V L +S +C
	1.2 TSI 1.4 TSI 1.6 TDI 2.0 TDI 2.0 TSI 2.0 TSI 2.5	77 118 77 103 147 155 125	07.11 04.11 10.11 04.11 04.11 05.13 04.11		PR: 1ZE,1ZP PR: 1ZE,1ZP PR: 1ZE,1ZP PR: 1ZE,1ZP PR: 1ZE,1ZP PR: 1ZE,1ZP PR: 1ZE,1ZP	G2125145		288 25,0 22,0 V L +S +C
	1.2 TSI 1.4 TSI 1.6 TDI 2.0 TDI 2.0 TSI 2.0 TSI 2.5	77 118 77 103 147 155 125	07.11 04.11 10.11 04.11 04.11 05.13 04.11		PR: 1KS,1KT PR: 1KS,1KT PR: 1KS,1KT PR: 1KS,1KT PR: 1KS,1KT PR: 1KS,1KT PR: 1KS,1KT	G2110356		272 9,7 8,0 +S +C
<b>VOLKSWAGEN BEETLE Convertible (12-)</b>								
	1.2 TSI 1.4 TSI 1.6 TDI 2.0 TDI 2.0 TSI 2.0 TSI	77 118 77 103 147 155	11.12 11.12 11.12 11.12 11.12 05.13		PR: 1ZQ PR: 1ZQ PR: 1ZQ PR: 1ZQ PR: 1ZQ PR: 1ZQ	G1020331		23130 19,7 + <b>VW</b>
	1.2 TSI 1.4 TSI 1.6 TDI 2.0 TDI 2.0 TSI 2.0 TSI	77 118 77 103 147 155	11.12 11.12 11.12 11.12 11.12 05.13		PR: 1ZM PR: 1ZM PR: 1ZM PR: 1ZM PR: 1ZM PR: 1ZM	G1020463		23131 19,7 +/Wl <b>VW</b>
	1.2 TSI 1.4 TSI 1.6 TDI 2.0 TDI 2.0 TSI 2.0 TSI	77 118 77 103 147 155	11.12 11.12 11.12 11.12 11.12 05.13		PR: 1ZA,1ZB,1ZE PR: 1ZA,1ZB,1ZE PR: 1ZA,1ZB,1ZE PR: 1ZA,1ZB,1ZE PR: 1ZA,1ZB,1ZE PR: 1ZA,1ZB,1ZE	G1020680		23587 20,6 +/Wl <b>ATE</b>
	1.2 TSI 1.4 TSI 1.6 TDI 2.0 TDI 2.0 TSI 2.0 TSI	77 118 77 103 147 155	11.12 11.12 11.12 11.12 11.12 05.13		PR: 1ZM,1ZQ PR: 1ZM,1ZQ PR: 1ZM,1ZQ PR: 1ZM,1ZQ PR: 1ZM,1ZQ PR: 1ZM,1ZQ	G2122210		280 22,0 19,0 V L +S +C
	1.2 TSI 1.4 TSI 1.6 TDI	77 118 77	11.12 11.12 11.12		PR: 1ZE,1ZP PR: 1ZE,1ZP PR: 1ZE,1ZP	G2125145		288 25,0 22,0 V L +S +C

										
<b>VOLKSWAGEN BEETLE Convertible (12-)</b>										
	2.0 TDI	103		11.12	PR: 1ZE,1ZP	G2125145		288 25,0 22,0 V L +S +C		
	2.0 TSI	147		11.12	PR: 1ZE,1ZP					
	2.0 TSI	155		05.13	PR: 1ZE,1ZP					
	1.2 TSI	77		11.12	PR: 1ZA,1ZB,1LV	G2125158		312 25,0 22,0 V L +S +C		
	1.4 TSI	118		11.12	PR: 1ZA,1ZB,1LV					
	1.6 TDI	77		11.12	PR: 1ZA,1ZB,1LV					
2.0 TDI	103		11.12	PR: 1ZA,1ZB,1LV						
2.0 TSI	147		11.12	PR: 1ZA,1ZB,1LV						
2.0 TSI	155		05.13	PR: 1ZA,1ZB,1LV						
	1.2 TSI	77		11.12	PR: 1KS,1KT	G2110356		272 9,7 8,0 +S +C		
	1.4 TSI	118		11.12	PR: 1KS,1KT					
	1.6 TDI	77		11.12	PR: 1KS,1KT					
	2.0 TDI	103		11.12	PR: 1KS,1KT					
	2.0 TSI	147		11.12	PR: 1KS,1KT					
	2.0 TSI	155		05.13	PR: 1KS,1KT					
<b>VOLKSWAGEN PASSAT (88-93)</b>										
	1.6 Saloon			04.88	09.89 - ABS	G1020009 G1020274		20887 19,7 +/Acc 20168 19,3 /S	VW LUC	
	1.6 Saloon			04.88	10.93 + ABS	G1020274		20168 19,3 /S	LUC	
	1.6 Saloon			10.89	10.93 - ABS					
	1.6 TD			08.88	10.93					
	1.6 Variant			04.88	10.93					
	1.8	55		04.88	10.93					
	1.8	66		04.88	10.93					
	1.8 Syncro G60			08.88	10.93					
	1.9 D			05.89	10.93					
	1.9 TD			03.91	10.93					
	2.8 VR6			06.91	10.93					
	1.8	79		04.88	07.90	G1020273		20168 16,0 /S	LUC	
	1.8	82		04.88	07.90					
	1.8 16V			04.88	07.92					
2.0			03.90	10.93						
2.0 16V			08.88	10.93						
2.0 Syncro			10.90	10.93						
	1.6			04.88	10.93	G2113178		256 12,9 11,0 +S +C		
	1.6 TD			08.88	10.93					
	1.8	55		04.88	10.93					
	1.8	66		04.88	10.93					
	1.9 D			05.89	10.93					
	1.9 TD			03.91	10.93					
	1.8	79		04.88	07.90	G2120128		256 20,0 18,0 V L +S +C		
	1.8	82		04.88	07.90					
	1.8 16V			04.88	07.92					
	2.0			03.90	10.93					
	2.0 16V			08.88	10.93					
	2.0 Syncro			10.90	10.93					
		1.8	79		04.88	07.90	G1020201		20961 15,2 /WD/Acc/S	LUC
		1.8	82		04.88	07.90				
1.8 16V				04.88	07.92					
1.8 Syncro G60				31-P-080000	08.88					
2.0				31-PE080000	03.90					
2.0				31-PB080000	03.90					
2.0 16V				31-PE080000	08.88					
2.0 16V				31-PB080000	08.88					
2.0 Syncro				31-P-080000	10.90					
2.8 VR6				31-PE080000	06.91					
2.8 VR6				31-PB080000	06.91					
1.8 Syncro G60		31-P-080001		10.93		G1020345		20961 17,0 /WD/Acc/S	LUC	
2.0		31-PB080001		10.93						
2.0		31-PE080001		10.93						
2.0 16V	31-PB080001		10.93							
2.0 16V	31-PE080001		10.93							
2.0 Syncro	31-P-080001		10.93							
2.8 VR6	31-PB080001		10.93							
2.8 VR6	31-PE080001		10.93							
	1.8	79		04.88	07.90	G2110111	without sensor ring 1)	226 10,0 8,0 +C		
	1.8	82		04.88	07.90					
	1.8 16V			04.88	07.92					
	2.0			03.90	10.93					
	2.0 16V			08.88	10.93					
	1.8 Syncro G60			08.88	10.93	G2110151		239 10,0 8,0 +S +C		
2.0 Syncro			10.90	10.93						
<b>VOLKSWAGEN PASSAT (94-96)</b>										
	1.6		3A-T-130756	10.94		G1020274		20168 19,3 /S	LUC	
	1.8			10.93	12.96					
	1.9 TD	55		10.93	12.96					
	1.9 TDI	66	3A-S-300000	10.93						
	1.9 TDI	81		03.96	12.96					
	1.6		3A-T-130757		12.96		G1020273		20168 16,0 /S	LUC
1.9 TDI	66	3A-T-000001		12.96						
2.0			10.93	12.96						
2.0 Syncro			01.94	12.96						
2.0 16V			01.94	12.96	G1020379		21911 20,3 +	ATE		

1) senza sensori / sans secours ABS / sin anillo sensor ABS / ohne Sensoring



**VOLKSWAGEN PASSAT (97-05)**

	2.3 4motion 2.5 TDI 2.5 TDI 4motion 2.8 2.8 2.8 4motion	3B-Y-000001 3B-Y-000001 3B-Y-000001 132 3B-Y-000001 142 3B-Y-000001 3B-Y-000001		06.05 PR: 1LE, 1LT 06.05 PR: 1LE, 1LT 06.05 PR: 1LE, 1LT 06.05 +  / + GUS States <sup>1)</sup> 06.05 PR: 1LE, 1LT 06.05 PR: 1LE, 1LT	<b>G1020313</b>		23018 20,3 +/Wl	<b>ATE</b>
	4.0 W8 4motion		09.01	06.05 PR: 1ZF,1ZG	<b>G1020683</b>	- armoured vehicles <sup>2)</sup>	21484 20,5 +/WD	<b>ATE</b>
	1.6 1.8 1.8 1.8 4motion 1.9 TDI	85 92 66		10.96 09.00 PR: 1LZ,1ZJ 01.97 09.00 +  / + GUS States <sup>1)</sup> 10.96 09.00 PR: 1LZ,1ZJ 10.96 09.00 PR: 1LZ,1ZJ 10.96 09.00 PR: 1LZ,1ZJ	<b>G2122152</b>		280 22,0 20,0 V L +C	
	1.6 1.8 1.8 4motion 1.8 T 1.9 TDI 1.9 TDI 1.9 TDI 1.9 TDI 4motion 2.3 2.3 4motion 2.8 2.8 2.8 4motion	92 66 81 85 85	3B-X-124107 3B-X-124107 3B-X-124107 3B-X-124107 3B-X-124107 3B-X-124107 3B-X-124107 3B-X-124107 3B-X-124107 3B-X-124107 3B-X-124107 3B-X-124107 3B-X-124107	10.96 10.96 10.96 10.96 10.96 10.96 10.96 10.96 10.96 06.97 01.97 08.96 10.96	PR: 1LB,1ZC PR: 1LB,1ZC PR: 1LB,1ZC PR: 1LB,1ZC PR: 1LB,1ZC PR: 1LB,1ZC PR: 1LB,1ZC PR: 1LB,1ZC PR: 1LB,1ZC PR: 1LB,1ZC +  / + GUS States <sup>1)</sup> PR: 1LB,1ZC PR: 1LB,1ZC	<b>G2125115</b>	283 25,0 23,0 V L +C	
	1.6 1.8 1.8 4motion 1.8 T 1.9 TDI 1.9 TDI 1.9 TDI 1.9 TDI 1.9 TDI 4motion 1.9 TDI 4motion 2.0 2.0 2.0 4motion 2.0 TDI 2.3 2.3 4motion 2.5 TDI 2.5 TDI 4motion	92 66 74 81 85 96 96 85 85 100	3B-X-124108 3B-X-124108 3B-X-124108 3B-X-124108 3B-X-124108 3B-X-124108 3B-X-124108 3B-X-124108 3B-X-124108 3B-X-124108 3B-X-124108 3B-X-124108 3B-X-124108	10.00 10.00 10.00 10.00 10.00 10.00 10.00 10.00 10.00 10.00 12.03 09.00 09.00 08.98 08.98	PR: 1LB,1LE,1ZC PR: 1LB,1LE,1ZC PR: 1LB,1LE,1ZC PR: 1LB,1LE,1ZC PR: 1LB,1LE,1ZC PR: 1LB,1LE,1ZC PR: 1LB,1LE,1ZC PR: 1LB,1LE,1ZC PR: 1LB,1LE,1ZC PR: 1LB,1LE,1ZC PR: 1LB,1LE,1ZC PR: 1LB,1LE,1ZC PR: 1LB,1LE,1ZC PR: 1LB,1LE,1ZC PR: 1LB,1LE,1ZC PR: 1LB,1LE,1ZC PR: 1LB,1LE,1ZC	<b>G2125171</b>	288 25,0 23,0 V L +C	
	2.8 2.8 2.8 4motion	132 142 3B-X-124108	3B-X-124108 3B-X-124108 3B-X-124108	06.05 +  / + GUS States <sup>1)</sup> 09.00 PR: 1LB,1LE,1ZC 09.00 PR: 1LB,1LE,1ZC	<b>G2125171</b>		288 25,0 23,0 V L +C	
	1.6 1.8 1.8 1.8 4motion 1.8 T 1.9 TDI 1.9 TDI 1.9 TDI 1.9 TDI 1.9 TDI 1.9 TDI 4motion 1.9 TDI 4motion 2.0 2.0 2.0 4motion 2.0 TDI 2.3 2.3 4motion 2.5 TDI 2.5 TDI 4motion	85 92 66 74 81 85 96 96 85 85 100		10.96 06.05 PR: 1KD,1KE,1KF,1KW 01.97 09.00 +  / + GUS States <sup>1)</sup> 10.96 09.00 PR: 1KD,1KE,1KF,1KW 10.96 09.00 PR: 1KD,1KE,1KF,1KW 10.96 06.05 PR: 1KD,1KE,1KF,1KW 10.96 09.00 PR: 1KD,1KE,1KF,1KW 10.00 06.05 PR: 1KD,1KE,1KF,1KW 10.96 06.05 PR: 1KD,1KE,1KF,1KW 08.98 06.05 PR: 1KD,1KE,1KF,1KW 10.00 06.05 PR: 1KD,1KE,1KF,1KW 10.96 06.05 PR: 1KD,1KE,1KF,1KW 10.00 06.05 PR: 1KD,1KE,1KF,1KW 10.00 06.05 PR: 1KD,1KE,1KF,1KW 05.02 06.05 PR: 1KD,1KE,1KF,1KW 10.00 06.05 PR: 1KD,1KE,1KF,1KW 12.03 06.05 PR: 1KD,1KE,1KF,1KW 10.96 06.05 PR: 1KD,1KE,1KF,1KW 06.97 06.05 PR: 1KD,1KE,1KF,1KW 08.98 06.05 PR: 1KD,1KE,1KF,1KW 08.98 06.05 PR: 1KD,1KE,1KF,1KW 01.97 06.05 +  / + GUS States <sup>1)</sup> 08.96 06.05 PR: 1KD,1KE,1KF,1KW 10.96 06.05 PR: 1KD,1KE,1KF,1KW 09.01 06.05 PR: 1KD,1KE,1KF,1KW	<b>G1020492</b>		23554 17,1 /WD/S	<b>LUC</b>
	1.6 1.8 1.8 1.8 T 1.9 TDI 1.9 TDI 1.9 TDI 1.9 TDI 1.9 TDI 1.9 TDI 1.9 TDI 4motion 1.9 TDI 4motion 2.0 2.0 2.0 4motion 2.0 TDI 2.3 2.3 4motion 2.5 TDI 2.5 TDI	85 92 66 74 81 85 96 96 85 85 100		10.96 06.05 PR: 1KD,1KE,1KF,1KW 01.97 09.00 +  / + GUS States <sup>1)</sup> 10.96 09.00 PR: 1KD,1KE,1KF,1KW 10.96 06.05 PR: 1KD,1KE,1KF,1KW 10.96 09.00 PR: 1KD,1KE,1KF,1KW 10.00 06.05 PR: 1KD,1KE,1KF,1KW 10.96 06.05 PR: 1KD,1KE,1KF,1KW 10.00 06.05 PR: 1KD,1KE,1KF,1KW 10.96 06.05 PR: 1KD,1KE,1KF,1KW 10.00 06.05 PR: 1KD,1KE,1KF,1KW 10.96 06.05 PR: 1KD,1KE,1KF,1KW 10.00 06.05 PR: 1KD,1KE,1KF,1KW 10.00 06.05 PR: 1KD,1KE,1KF,1KW 05.02 06.05 PR: 1KD,1KE,1KF,1KW 10.00 06.05 PR: 1KD,1KE,1KF,1KW 12.03 06.05 PR: 1KD,1KE,1KF,1KW 10.96 06.05 PR: 1KD,1KE,1KF,1KW 08.98 06.05 PR: 1KD,1KE,1KF,1KW 08.98 06.05 PR: 1KD,1KE,1KF,1KW 01.97 06.05 +  / + GUS States <sup>1)</sup> 08.96 06.05 PR: 1KD,1KE,1KF,1KW 10.96 06.05 PR: 1KD,1KE,1KF,1KW 09.01 06.05 PR: 1KD,1KE,1KF,1KW	<b>G2110201</b>		245 10,0 8,0 +C	

<sup>1)</sup> + / + Stati del GUS / + / + Etats de la CEI / + / + estados del GUS / + / + GUS-Staaten

<sup>2)</sup> - veicoli blindati / - véhicule blindé / - vehiculo blindado / - gepanzerte Fahrzeuge

VOLKSWAGEN PASSAT (97-05)		08.96		06.05		PR: 1KD,1KE,1KF,1KW		G2110201		245 10,0 8,0 +C	
<b>VOLKSWAGEN PASSAT Saloon (05-10)</b>											
	1.4 TSI	75	10.07	07.10	PR: 1LJ,1LH,1ZG,1ZM		G1020680			23587 20,6 +/WI	ATE
	1.6	85	03.05	07.10	PR: 1LJ,1LH,1ZG,1ZM						
	1.6 FSI	85	03.05	07.10	PR: 1LJ,1LH,1ZG,1ZM						
	1.6 TDI	77	08.09	07.10	PR: 1LJ,1LH,1ZG,1ZM						
	1.8 TSI	112	11.09	07.10	PR: 1LJ,1LH,1ZG,1ZM						
	1.8 TSI	118	10.07	07.10	PR: 1LJ,1LH,1ZG,1ZM						
	1.9 TDI	77	03.05	07.10	PR: 1LJ,1LH,1ZG,1ZM						
	2.0 FSI	110	03.05	07.10	PR: 1LJ,1LH,1ZG,1ZM						
	2.0 FSI 4motion	110	03.05	07.10	PR: 1LJ,1LH,1ZG,1ZM						
	2.0 TDI		03.05	07.10	PR: 1LJ,1LH,1ZG,1ZM						
	2.0 TDI	120	03.05	07.10	PR: 1LJ,1LH,1ZG,1ZM						
	2.0 TDI	125	08.05	07.10	PR: 1LJ,1LH,1ZG,1ZM						
	2.0 TDI 16V	103	08.05	07.10	PR: 1LJ,1LH,1ZG,1ZM						
	2.0 TDI 4motion	103	03.05	07.10	PR: 1LJ,1LH,1ZG,1ZM						
	2.0 TDI 4motion	125	03.05	07.10	PR: 1LJ,1LH,1ZG,1ZM						
	2.0 TFSI	147	05.09	07.10	PR: 1LJ,1LH,1ZG,1ZM						
	3.2 V6 FSI	184	03.05	07.10	PR: 1LJ,1LH,1ZG,1ZM						
	3.2 V6 FSI 4motion	184	11.05	07.10	PR: 1LJ,1LH,1ZG,1ZM						
	3.6 R36	220	09.05	07.10	PR: 1LJ,1LH,1ZG,1ZM						
			04.07	07.10	PR: 1LJ,1LH,1ZG,1ZM						
	1.4 TSI	75	10.07	07.10	PR: 1LK,1LM		G1020753			23801 20,3 +/WI	ATE
	1.6	85	03.05	07.10	PR: 1LK,1LM						
	1.6 FSI	85	03.05	07.10	PR: 1LK,1LM						
	1.6 TDI	77	08.09	07.10	PR: 1LK,1LM						
	1.8 TSI	112	11.09	07.10	PR: 1LK,1LM						
	1.8 TSI	118	10.07	07.10	PR: 1LK,1LM						
	1.9 TDI	77	03.05	07.10	PR: 1LK,1LM						
	2.0 FSI	110	03.05	07.10	PR: 1LK,1LM						
	2.0 FSI 4motion	110	03.05	07.10	PR: 1LK,1LM						
	2.0 TDI		03.05	07.10	PR: 1LK,1LM						
	2.0 TDI	120	03.05	07.10	PR: 1LK,1LM						
	2.0 TDI	125	08.05	07.10	PR: 1LK,1LM						
	2.0 TDI 16V	103	08.05	07.10	PR: 1LK,1LM						
	2.0 TDI 4motion	103	03.05	07.10	PR: 1LK,1LM						
	2.0 TDI 4motion	125	05.09	07.10	PR: 1LK,1LM						
	2.0 TFSI	147	03.05	07.10	PR: 1LK,1LM						
	3.2 V6 FSI	184	11.05	07.10	PR: 1LK,1LM						
	3.2 V6 FSI 4motion	184	09.05	07.10	PR: 1LK,1LM						
	3.6 R36	220	04.07	07.10	PR: 1LK,1LM						
		1.4 TSI	75	10.07	07.10	PR: 1LJ,1LH,1ZG,1ZM					
1.6		85	03.05	07.10	PR: 1LJ,1LH,1ZG,1ZM						
1.6 FSI		85	03.05	07.10	PR: 1LJ,1LH,1ZG,1ZM						
1.6 TDI		77	08.09	07.10	PR: 1LJ,1LH,1ZG,1ZM						
1.8 TSI		112	11.09	07.10	PR: 1LJ,1LH,1ZG,1ZM						
1.8 TSI		118	10.07	07.10	PR: 1LJ,1LH,1ZG,1ZM						
1.9 TDI		77	03.05	07.10	PR: 1LJ,1LH,1ZG,1ZM						
2.0 FSI		110	03.05	07.10	PR: 1LJ,1LH,1ZG,1ZM						
2.0 FSI 4motion		110	03.05	07.10	PR: 1LJ,1LH,1ZG,1ZM						
2.0 TDI			03.05	07.10	PR: 1LJ,1LH,1ZG,1ZM						
2.0 TDI		120	03.05	07.10	PR: 1LJ,1LH,1ZG,1ZM						
2.0 TDI		125	08.05	07.10	PR: 1LJ,1LH,1ZG,1ZM						
2.0 TDI 16V		103	08.05	07.10	PR: 1LJ,1LH,1ZG,1ZM						
2.0 TDI 4motion		103	03.05	07.10	PR: 1LJ,1LH,1ZG,1ZM						
2.0 TDI 4motion		125	03.05	07.10	PR: 1LJ,1LH,1ZG,1ZM						
2.0 TFSI		147	05.09	07.10	PR: 1LJ,1LH,1ZG,1ZM						
3.2 V6 FSI		184	03.05	07.10	PR: 1LJ,1LH,1ZG,1ZM						
3.2 V6 FSI 4motion		184	11.05	07.10	PR: 1LJ,1LH,1ZG,1ZM						
3.6 R36		220	09.05	07.10	PR: 1LJ,1LH,1ZG,1ZM						
			04.07	07.10	PR: 1LJ,1LH,1ZG,1ZM						
	1.4 TSI	75	10.07	07.10	PR: 1LK,1LM		G2130115			345 30,0 27,0 V L +C	
	1.6	85	03.05	07.10	PR: 1LK,1LM						
	1.6 FSI	85	03.05	07.10	PR: 1LK,1LM						
	1.6 TDI	77	08.09	07.10	PR: 1LK,1LM						
	1.8 TSI	112	11.09	07.10	PR: 1LK,1LM						
	1.8 TSI	118	10.07	07.10	PR: 1LK,1LM						
	1.9 TDI	77	03.05	07.10	PR: 1LK,1LM						
	2.0 FSI	110	03.05	07.10	PR: 1LK,1LM						
	2.0 FSI 4motion	110	03.05	07.10	PR: 1LK,1LM						
	2.0 TDI		03.05	07.10	PR: 1LK,1LM						
	2.0 TDI	120	03.05	07.10	PR: 1LK,1LM						
	2.0 TDI	125	08.05	07.10	PR: 1LK,1LM						
	2.0 TDI 16V	103	08.05	07.10	PR: 1LK,1LM						
	2.0 TDI 4motion	103	03.05	07.10	PR: 1LK,1LM						
	2.0 TDI 4motion	125	05.09	07.10	PR: 1LK,1LM						
	2.0 TFSI	147	03.05	07.10	PR: 1LK,1LM						
	3.2 V6 FSI	184	11.05	07.10	PR: 1LK,1LM						
	3.2 V6 FSI 4motion	184	09.05	07.10	PR: 1LK,1LM						
	3.6 R36	220	04.07	07.10	PR: 1LK,1LM						

















**VOLKSWAGEN PASSAT Saloon (05-10)**

	1.4 TSI		10.07	07.10	PR: 1KU,1KW	G1020682 G1020993	electric parking brake <sup>1)</sup> electric parking brake <sup>1)</sup>	23914 17,1 /WD/Acc/S 24483 16,9 /Acc/S	LUC LUC
	1.6	75	03.05	07.10	PR: 1KU,1KW				
	1.6 FSI	85	03.05	07.10	PR: 1KU,1KW				
	1.6 TDI	77	08.09	07.10	PR: 1KU,1KW				
	1.8 TSI	112	11.09	07.10	PR: 1KU,1KW				
	1.8 TSI	118	10.07	07.10	PR: 1KU,1KW				
	1.9 TDI	77	03.05	07.10	PR: 1KU,1KW				
	2.0 FSI	110	03.05	07.10	PR: 1KU,1KW				
	2.0 FSI 4motion	110	03.05	07.10	PR: 1KU,1KW				
	2.0 TDI		03.05	07.10	PR: 1KU,1KW				
	2.0 TDI		03.05	07.10	PR: 1KU,1KW				
	2.0 TDI	120	08.05	07.10	PR: 1KU,1KW				
	2.0 TDI	125	08.05	07.10	PR: 1KU,1KW				
	2.0 TDI 16V	103	03.05	07.10	PR: 1KU,1KW				
	2.0 TDI 4motion	103	03.05	07.10	PR: 1KU,1KW				
	2.0 TDI 4motion	125	05.09	07.10	PR: 1KU,1KW				
	2.0 TFSI	147	03.05	07.10	PR: 1KU,1KW				
	3.2 V6 FSI	184	11.05	07.10	PR: 1KU,1KW				
	3.2 V6 FSI 4motion	184	09.05	07.10	PR: 1KU,1KW				
	3.6 R36	220	04.07	07.10	PR: 1KU,1KW				
	1.4 TSI		10.07	07.10	PR: 2EA,2EL	G1020734	electric parking brake <sup>1)</sup>	23914 17,1 /WD/Acc/S	LUC
	1.6	75	03.05	07.10	PR: 2EA,2EL				
	1.6 FSI	85	03.05	07.10	PR: 2EA,2EL				
	1.6 TDI	77	08.09	07.10	PR: 2EA,2EL				
	1.8 TSI	112	11.09	07.10	PR: 2EA,2EL				
	1.8 TSI	118	10.07	07.10	PR: 2EA,2EL				
	1.9 TDI	77	03.05	07.10	PR: 2EA,2EL				
	2.0 FSI	110	03.05	07.10	PR: 2EA,2EL				
	2.0 FSI 4motion	110	03.05	07.10	PR: 2EA,2EL				
	2.0 TDI		03.05	07.10	PR: 2EA,2EL				
	2.0 TDI	120	08.05	07.10	PR: 2EA,2EL				
	2.0 TDI	125	08.05	07.10	PR: 2EA,2EL				
	2.0 TDI 16V	103	03.05	07.10	PR: 2EA,2EL				
	2.0 TDI 4motion	103	03.05	07.10	PR: 2EA,2EL				
	2.0 TDI 4motion	125	05.09	07.10	PR: 2EA,2EL				
	2.0 TFSI	147	03.05	07.10	PR: 2EA,2EL				
	3.2 V6 FSI	184	11.05	07.10	PR: 2EA,2EL				
	3.2 V6 FSI 4motion	184	09.05	07.10	PR: 2EA,2EL				
	3.6 R36	220	04.07	07.10	PR: 2EA,2EL				
		1.4 TSI		10.07	07.10				
1.6		75	03.05	07.10	PR: 1KU,1KW				
1.6 FSI		85	03.05	07.10	PR: 1KU,1KW				
1.6 TDI		77	08.09	07.10	PR: 1KU,1KW				
1.8 TSI		112	11.09	07.10	PR: 1KU,1KW				
1.8 TSI		118	10.07	07.10	PR: 1KU,1KW				
1.9 TDI		77	03.05	07.10	PR: 1KU,1KW				
2.0 FSI		110	03.05	07.10	PR: 1KU,1KW				
2.0 FSI 4motion		110	03.05	07.10	PR: 1KU,1KW				
2.0 TDI			03.05	07.10	PR: 1KU,1KW				
2.0 TDI			03.05	07.10	PR: 1KU,1KW				
2.0 TDI		120	08.05	07.10	PR: 1KU,1KW				
2.0 TDI		125	08.05	07.10	PR: 1KU,1KW				
2.0 TDI 16V		103	03.05	07.10	PR: 1KU,1KW				
2.0 TDI 4motion		103	03.05	07.10	PR: 1KU,1KW				
2.0 TDI 4motion		125	05.09	07.10	PR: 1KU,1KW				
2.0 TFSI		147	03.05	07.10	PR: 1KU,1KW				
3.2 V6 FSI		184	11.05	07.10	PR: 1KU,1KW				
3.2 V6 FSI 4motion		184	09.05	07.10	PR: 1KU,1KW				
3.6 R36		220	04.07	07.10	PR: 1KU,1KW				

**VOLKSWAGEN PASSAT Variant (05-10)**

	1.4 TSI	90	10.07	07.10	PR: 1LJ,1LH,1ZG,1ZM	G1020680		23587 20,6 +/Wl	ATE
	1.6	75	07.05	07.10	PR: 1LJ,1LH,1ZG,1ZM				
	1.6 FSI	85	07.05	07.10	PR: 1LJ,1LH,1ZG,1ZM				
	1.6 TDI	77	08.09	07.10	PR: 1LJ,1LH,1ZG,1ZM				
	1.8 TSI	112	11.09	07.10	PR: 1LJ,1LH,1ZG,1ZM				
	1.8 TSI	118	10.07	07.10	PR: 1LJ,1LH,1ZG,1ZM				
	1.9 TDI	77	07.05	07.10	PR: 1LJ,1LH,1ZG,1ZM				
	2.0 FSI	110	07.05	07.10	PR: 1LJ,1LH,1ZG,1ZM				
	2.0 FSI 4motion	110	09.05	07.10	PR: 1LJ,1LH,1ZG,1ZM				
	2.0 TDI		11.05	07.10	PR: 1LJ,1LH,1ZG,1ZM				
	2.0 TDI		07.05	07.10	PR: 1LJ,1LH,1ZG,1ZM				
	2.0 TDI	90	07.05	07.10	PR: 1LJ,1LH,1ZG,1ZM				
	2.0 TDI	100	07.05	07.10	PR: 1LJ,1LH,1ZG,1ZM				
	2.0 TDI	125	07.05	07.10	PR: 1LJ,1LH,1ZG,1ZM				
	2.0 TDI 16V	103	08.05	07.10	PR: 1LJ,1LH,1ZG,1ZM				
	2.0 TDI 4motion	103	09.05	07.10	PR: 1LJ,1LH,1ZG,1ZM				
	2.0 TDI 4motion	125	05.09	07.10	PR: 1LJ,1LH,1ZG,1ZM				
	2.0 TFSI	147	07.05	07.10	PR: 1LJ,1LH,1ZG,1ZM				
	3.2 V6 FSI	184	11.05	07.10	PR: 1LJ,1LH,1ZG,1ZM				
	3.2 V6 FSI 4motion	184	11.05	07.10	PR: 1LJ,1LH,1ZG,1ZM				
3.6 R36	220	04.07	07.10	PR: 1LJ,1LH,1ZG,1ZM					
	1.4 TSI	90	10.07	07.10	PR: 1LK,1LM	G1020753		23801 20,3 +/Wl	ATE
	1.6	75	07.05	07.10	PR: 1LK,1LM				
	1.6 FSI	85	07.05	07.10	PR: 1LK,1LM				
	1.6 TDI	77	08.09	07.10	PR: 1LK,1LM				

<sup>1)</sup> fr. di stazionamento elettrico / frein à main électrique / freno de mano eléctrico / elektrische Feststellbremse

VOLKSWAGEN PASSAT Variant (05-10)											
											
	1.8 TSI 112 1.8 TSI 118 1.9 TDI 77 2.0 FSI 110 2.0 FSI 4motion 110 2.0 TDI 90 2.0 TDI 100 2.0 TDI 125 2.0 TDI 16V 103 2.0 TDI 4motion 103 2.0 TDI 4motion 125 2.0 TFSI 147 3.2 V6 FSI 184 3.2 V6 FSI 4motion 184 3.6 R36 220			11.09 07.10 PR: 1LK,1LM 10.07 07.10 PR: 1LK,1LM 07.05 07.10 PR: 1LK,1LM 07.05 07.10 PR: 1LK,1LM 09.05 07.10 PR: 1LK,1LM 11.05 07.10 PR: 1LK,1LM 07.05 07.10 PR: 1LK,1LM 07.05 07.10 PR: 1LK,1LM 07.05 07.10 PR: 1LK,1LM 08.05 07.10 PR: 1LK,1LM 09.05 07.10 PR: 1LK,1LM 05.09 07.10 PR: 1LK,1LM 07.05 07.10 PR: 1LK,1LM 11.05 07.10 PR: 1LK,1LM 11.05 07.10 PR: 1LK,1LM 04.07 07.10 PR: 1LK,1LM	G1020753			23801 20,3 +/Wl	ATE		
	1.4 TSI 90 1.6 75 1.6 FSI 85 1.6 TDI 77 1.8 TSI 112 1.8 TSI 118 1.9 TDI 77 2.0 FSI 110 2.0 FSI 4motion 110 2.0 TDI 90 2.0 TDI 100 2.0 TDI 125 2.0 TDI 16V 103 2.0 TDI 4motion 103 2.0 TDI 4motion 125 2.0 TFSI 147 3.2 V6 FSI 184 3.2 V6 FSI 4motion 184 3.6 R36 220			10.07 07.10 PR: 1LJ,1LH,1ZG,1ZM 07.05 07.10 PR: 1LJ,1LH,1ZG,1ZM 07.05 07.10 PR: 1LJ,1LH,1ZG,1ZM 08.09 07.10 PR: 1LJ,1LH,1ZG,1ZM 11.09 07.10 PR: 1LJ,1LH,1ZG,1ZM 10.07 07.10 PR: 1LJ,1LH,1ZG,1ZM 07.05 07.10 PR: 1LJ,1LH,1ZG,1ZM 07.05 07.10 PR: 1LJ,1LH,1ZG,1ZM 09.05 07.10 PR: 1LJ,1LH,1ZG,1ZM 11.05 07.10 PR: 1LJ,1LH,1ZG,1ZM 07.05 07.10 PR: 1LJ,1LH,1ZG,1ZM 07.05 07.10 PR: 1LJ,1LH,1ZG,1ZM 07.05 07.10 PR: 1LJ,1LH,1ZG,1ZM 08.05 07.10 PR: 1LJ,1LH,1ZG,1ZM 09.05 07.10 PR: 1LJ,1LH,1ZG,1ZM 05.09 07.10 PR: 1LJ,1LH,1ZG,1ZM 07.05 07.10 PR: 1LJ,1LH,1ZG,1ZM 11.05 07.10 PR: 1LJ,1LH,1ZG,1ZM 11.05 07.10 PR: 1LJ,1LH,1ZG,1ZM 04.07 07.10 PR: 1LJ,1LH,1ZG,1ZM	G2125158			312 25,0 22,0 V L +S +C			
	1.4 TSI 90 1.6 75 1.6 FSI 85 1.6 TDI 77 1.8 TSI 112 1.8 TSI 118 1.9 TDI 77 2.0 FSI 110 2.0 FSI 4motion 110 2.0 TDI 90 2.0 TDI 100 2.0 TDI 125 2.0 TDI 16V 103 2.0 TDI 4motion 103 2.0 TDI 4motion 125 2.0 TFSI 147 3.2 V6 FSI 184 3.2 V6 FSI 4motion 184 3.6 R36 220			10.07 07.10 PR: 1LK,1LM 07.05 07.10 PR: 1LK,1LM 07.05 07.10 PR: 1LK,1LM 08.09 07.10 PR: 1LK,1LM 11.09 07.10 PR: 1LK,1LM 10.07 07.10 PR: 1LK,1LM 07.05 07.10 PR: 1LK,1LM 07.05 07.10 PR: 1LK,1LM 09.05 07.10 PR: 1LK,1LM 11.05 07.10 PR: 1LK,1LM 07.05 07.10 PR: 1LK,1LM 07.05 07.10 PR: 1LK,1LM 07.05 07.10 PR: 1LK,1LM 08.05 07.10 PR: 1LK,1LM 09.05 07.10 PR: 1LK,1LM 05.09 07.10 PR: 1LK,1LM 07.05 07.10 PR: 1LK,1LM 11.05 07.10 PR: 1LK,1LM 11.05 07.10 PR: 1LK,1LM 04.07 07.10 PR: 1LK,1LM	G2130115			345 30,0 27,0 V L +C			
	1.4 TSI 90 1.6 75 1.6 FSI 85 1.6 TDI 77 1.8 TSI 112 1.8 TSI 118 1.9 TDI 77 2.0 FSI 110 2.0 FSI 4motion 110 2.0 TDI 90 2.0 TDI 100 2.0 TDI 125 2.0 TDI 16V 103 2.0 TDI 4motion 103 2.0 TDI 4motion 125 2.0 TFSI 147 3.2 V6 FSI 184 3.2 V6 FSI 4motion 184 3.6 R36 220			10.07 07.10 PR: 1KU,1KW 07.05 07.10 PR: 1KU,1KW 07.05 07.10 PR: 1KU,1KW 08.09 07.10 PR: 1KU,1KW 11.09 07.10 PR: 1KU,1KW 10.07 07.10 PR: 1KU,1KW 07.05 07.10 PR: 1KU,1KW 07.05 07.10 PR: 1KU,1KW 09.05 07.10 PR: 1KU,1KW 11.05 07.10 PR: 1KU,1KW 07.05 07.10 PR: 1KU,1KW 07.05 07.10 PR: 1KU,1KW 07.05 07.10 PR: 1KU,1KW 08.05 07.10 PR: 1KU,1KW 09.05 07.10 PR: 1KU,1KW 05.09 07.10 PR: 1KU,1KW 07.05 07.10 PR: 1KU,1KW 11.05 07.10 PR: 1KU,1KW 11.05 07.10 PR: 1KU,1KW 04.07 07.10 PR: 1KU,1KW	G1020682 G1020993	electric parking brake <sup>1)</sup> electric parking brake <sup>1)</sup>	23914 17,1 /WD/Acc/S 24483 16,9 /Acc/S	LUC LUC			
	1.4 TSI 90 1.6 75 1.6 FSI 85 1.6 TDI 77 1.8 TSI 112 1.8 TSI 118 1.9 TDI 77			10.07 07.10 PR: 2EA,2EL 07.05 07.10 PR: 2EA,2EL 07.05 07.10 PR: 2EA,2EL 08.09 07.10 PR: 2EA,2EL 11.09 07.10 PR: 2EA,2EL 10.07 07.10 PR: 2EA,2EL 07.05 07.10 PR: 2EA,2EL	G1020734	electric parking brake <sup>1)</sup>	23914 17,1 /WD/Acc/S	LUC			

<sup>1)</sup> fr. di stazionamento elettrico / frein à main électrique / freno de mano eléctrico / elektrische Feststellbremse

















**VOLKSWAGEN PASSAT Variant (05-10)**

	2.0 FSI	110	07.05	07.10	PR: 2EA,2EL	G1020734	electric parking brake <sup>1)</sup>	23914 17,1 /WD/Acc/S	LUC
	2.0 FSI 4motion	110	09.05	07.10	PR: 2EA,2EL				
	2.0 TDI		11.05	07.10	PR: 2EA,2EL				
	2.0 TDI		07.05	07.10	PR: 2EA,2EL				
	2.0 TDI	90	07.05	07.10	PR: 2EA,2EL				
	2.0 TDI	100	07.05	07.10	PR: 2EA,2EL				
	2.0 TDI	125	07.05	07.10	PR: 2EA,2EL				
	2.0 TDI 16V	103	08.05	07.10	PR: 2EA,2EL				
	2.0 TDI 4motion	103	09.05	07.10	PR: 2EA,2EL				
	2.0 TDI 4motion	125	05.09	07.10	PR: 2EA,2EL				
	2.0 TFSI	147	07.05	07.10	PR: 2EA,2EL				
	3.2 V6 FSI	184	11.05	07.10	PR: 2EA,2EL				
	3.2 V6 FSI 4motion	184	11.05	07.10	PR: 2EA,2EL				
3.6 R36	220	04.07	07.10	PR: 2EA,2EL					
	1.4 TSI	90	10.07	07.10	PR: 1KU,1KW	G2112169	electric parking brake <sup>1)</sup>	282 12,0 10,0 +S +C	
	1.6	75	07.05	07.10	PR: 1KU,1KW				
	1.6 FSI	85	07.05	07.10	PR: 1KU,1KW				
	1.6 TDI	77	08.09	07.10	PR: 1KU,1KW				
	1.8 TSI	112	11.09	07.10	PR: 1KU,1KW				
	1.8 TSI	118	10.07	07.10	PR: 1KU,1KW				
	1.9 TDI	77	07.05	07.10	PR: 1KU,1KW				
	2.0 FSI	110	07.05	07.10	PR: 1KU,1KW				
	2.0 FSI 4motion	110	09.05	07.10	PR: 1KU,1KW				
	2.0 TDI		11.05	07.10	PR: 1KU,1KW				
	2.0 TDI		07.05	07.10	PR: 1KU,1KW				
	2.0 TDI	90	07.05	07.10	PR: 1KU,1KW				
	2.0 TDI	100	07.05	07.10	PR: 1KU,1KW				
	2.0 TDI	125	07.05	07.10	PR: 1KU,1KW				
	2.0 TDI 16V	103	08.05	07.10	PR: 1KU,1KW				
	2.0 TDI 4motion	103	09.05	07.10	PR: 1KU,1KW				
	2.0 TDI 4motion	125	05.09	07.10	PR: 1KU,1KW				
	2.0 TFSI	147	07.05	07.10	PR: 1KU,1KW				
	3.2 V6 FSI	184	11.05	07.10	PR: 1KU,1KW				
	3.2 V6 FSI 4motion	184	11.05	07.10	PR: 1KU,1KW				
3.6 R36	220	04.07	07.10	PR: 1KU,1KW					



















**VOLKSWAGEN PASSAT CC (08-11)**

	1.4 TSI MultiFuel	118	01.11	09.11	PR: 1LH,1ZM,1ZG	G1020680		23587 20,6 +/Wl	ATE
	1.8 TSI		04.08	09.11	PR: 1LH,1ZM,1ZG				
	2.0 TDI		04.08	09.11	PR: 1LH,1ZM,1ZG				
	2.0 TDI	125	06.08	09.11	PR: 1LH,1ZM,1ZG				
	2.0 TDI 4motion	103	08.09	09.11	PR: 1LH,1ZM,1ZG				
	2.0 TDI 4motion	125	11.09	09.11	PR: 1LH,1ZM,1ZG				
	2.0 TSI		04.08	09.11	PR: 1LH,1ZM,1ZG				
3.6 V6 4motion	220	04.08	09.11	PR: 1LH,1ZM,1ZG					
	1.4 TSI MultiFuel	118	01.11	09.11	PR: 1LK	G1020753		23801 20,3 +/Wl	ATE
	1.8 TSI		04.08	09.11	PR: 1LK				
	2.0 TDI		04.08	09.11	PR: 1LK				
	2.0 TDI	125	06.08	09.11	PR: 1LK				
	2.0 TDI 4motion	103	08.09	09.11	PR: 1LK				
	2.0 TDI 4motion	125	11.09	09.11	PR: 1LK				
	2.0 TSI		04.08	09.11	PR: 1LK				
3.6 V6 4motion	220	04.08	09.11	PR: 1LK					
	1.4 TSI MultiFuel	118	01.11	09.11	PR: 1LH,1ZM,1ZG	G2125158		312 25,0 22,0 V L +S +C	
	1.8 TSI		04.08	09.11	PR: 1LH,1ZM,1ZG				
	2.0 TDI		04.08	09.11	PR: 1LH,1ZM,1ZG				
	2.0 TDI	125	06.08	09.11	PR: 1LH,1ZM,1ZG				
	2.0 TDI 4motion	103	08.09	09.11	PR: 1LH,1ZM,1ZG				
	2.0 TDI 4motion	125	11.09	09.11	PR: 1LH,1ZM,1ZG				
	2.0 TSI		04.08	09.11	PR: 1LH,1ZM,1ZG				
3.6 V6 4motion	220	04.08	09.11	PR: 1LH,1ZM,1ZG					
	1.4 TSI MultiFuel	118	01.11	09.11	PR: 1LK	G2130115		345 30,0 27,0 V L +C	
	1.8 TSI		04.08	09.11	PR: 1LK				
	2.0 TDI		04.08	09.11	PR: 1LK				
	2.0 TDI	125	06.08	09.11	PR: 1LK				
	2.0 TDI 4motion	103	08.09	09.11	PR: 1LK				
	2.0 TDI 4motion	125	11.09	09.11	PR: 1LK				
	2.0 TSI		04.08	09.11	PR: 1LK				
3.6 V6 4motion	220	04.08	09.11	PR: 1LK					
	1.4 TSI MultiFuel	118	01.11	09.11	PR: 1KU,1KW	G1020682	electric parking brake <sup>1)</sup>	23914 17,1 /WD/Acc/S	LUC
	1.8 TSI		04.08	09.11	PR: 1KU,1KW				
	2.0 TDI		04.08	09.11	PR: 1KU,1KW	G1020993	electric parking brake <sup>1)</sup>	24483 16,9 /Acc/S	LUC
	2.0 TDI	125	06.08	09.11	PR: 1KU,1KW				
	2.0 TDI 4motion	125	11.09	09.11	PR: 1KU,1KW	G1020734	electric parking brake <sup>1)</sup>	23914 17,1 /WD/Acc/S	LUC
	2.0 TDI 4motion	125	11.09	09.11	PR: 1KU,1KW				
	2.0 TSI		04.08	09.11	PR: 1KU,1KW	G1020734	electric parking brake <sup>1)</sup>	23914 17,1 /WD/Acc/S	LUC
	3.6 V6 4motion	220	04.08	09.11	PR: 1KU,1KW				
	1.4 TSI MultiFuel	118	01.11	09.11	PR: 2EA	G1020734	electric parking brake <sup>1)</sup>	23914 17,1 /WD/Acc/S	LUC
	1.8 TSI		04.08	09.11	PR: 2EA				
	2.0 TDI		04.08	09.11	PR: 2EA	G1020734	electric parking brake <sup>1)</sup>	23914 17,1 /WD/Acc/S	LUC
	2.0 TDI	125	06.08	09.11	PR: 2EA				
	2.0 TDI 4motion	125	11.09	09.11	PR: 2EA	G1020734	electric parking brake <sup>1)</sup>	23914 17,1 /WD/Acc/S	LUC
2.0 TDI 4motion	125	11.09	09.11	PR: 2EA					
2.0 TSI		04.08	09.11	PR: 2EA	G1020734	electric parking brake <sup>1)</sup>	23914 17,1 /WD/Acc/S	LUC	
3.6 V6 4motion	220	04.08	09.11	PR: 2EA					

<sup>1)</sup> fr.di stazionamento elettrico / frein à main électrique / freno de mano eléctrico / elektrische Feststellbremse

									
<b>VOLKSWAGEN PASSAT CC (08-11)</b>									
	1.4 TSI MultiFuel	118		01.11	09.11	PR: 1KU	G2112169	electric parking brake <sup>1)</sup>	282 12,0 10,0 +S +C
	1.8 TSI			04.08	09.11	PR: 1KU			
	2.0 TDI			04.08	09.11	PR: 1KU			
	2.0 TDI	125		06.08	09.11	PR: 1KU			
	2.0 TSI			04.08	09.11	PR: 1KU			
	3.6 V6 4motion	220		04.08	09.11	PR: 1KU			
	1.4 TSI MultiFuel	118		01.11	09.11	PR: 1KW			
	1.8 TSI			04.08	09.11	PR: 1KW			
	2.0 TDI			04.08	09.11	PR: 1KW			
	2.0 TDI	125		06.08	09.11	PR: 1KW			
2.0 TDI 4motion	103		08.09	09.11	PR: 1KW				
2.0 TDI 4motion	125		11.09	09.11	PR: 1KW				
2.0 TSI			04.08	09.11	PR: 1KW				
3.6 V6 4motion	220		04.08	09.11	PR: 1KW				
<b>VOLKSWAGEN PASSAT / PASSAT VARIANT (10-)</b>									
	1.4 TSI	90		08.10		PR: 1ZM,1ZG	G1020680		23587 20,6 +/W/ ATE
	1.4 TSI	110		08.10		PR: 1ZM,1ZG			
	1.4 TSI	118		11.12		PR: 1ZM,1ZG			
	1.6 TDI	77		08.10		PR: 1ZM,1ZG			
	1.8 TSI	118		08.10		PR: 1ZM,1ZG			
	2.0 TDI			08.10		PR: 1ZM,1ZG			
	2.0 TDI	125		08.10		PR: 1ZM,1ZG			
	2.0 TDI	130		12.12		PR: 1ZM,1ZG			
	2.0 TDI 4motion	103		08.10		PR: 1ZM,1ZG			
	2.0 TDI 4motion	125		08.10		PR: 1ZM,1ZG			
	2.0 TDI 4motion	130		01.13		PR: 1ZM,1ZG			
	2.0 TSI	155		11.10		PR: 1ZM,1ZG			
	2.0 TSI 4motion	155		01.12		PR: 1ZM,1ZG			
3.6 FSI 4motion	220		01.11		PR: 1ZM,1ZG				
	1.4 TSI	90		08.10		PR: 1ZM,1ZG	G2125158		312 25,0 22,0 V L +S +C
	1.4 TSI	110		08.10		PR: 1ZM,1ZG			
	1.4 TSI	118		11.12		PR: 1ZM,1ZG			
	1.6 TDI	77		08.10		PR: 1ZM,1ZG			
	1.8 TSI	118		08.10		PR: 1ZM,1ZG			
	2.0 TDI			08.10		PR: 1ZM,1ZG			
	2.0 TDI	125		08.10		PR: 1ZM,1ZG			
	2.0 TDI	130		12.12		PR: 1ZM,1ZG			
	2.0 TDI 4motion	103		08.10		PR: 1ZM,1ZG			
	2.0 TDI 4motion	125		08.10		PR: 1ZM,1ZG			
	2.0 TDI 4motion	130		01.13		PR: 1ZM,1ZG			
	2.0 TSI	155		11.10		PR: 1ZM,1ZG			
	2.0 TSI 4motion	155		01.12		PR: 1ZM,1ZG			
3.6 FSI 4motion	220		01.11		PR: 1ZM,1ZG				
	1.4 TSI	90		08.10		PR: 1KW	G1020993	electric parking brake <sup>1)</sup>	24483 16,9 /Acc/S LUC
	1.4 TSI	110		08.10		PR: 1KW			
	1.4 TSI	118		11.12		PR: 1KW			
	1.6 TDI	77		08.10		PR: 1KW			
	1.8 TSI	118		08.10		PR: 1KW			
	2.0 TDI			08.10		PR: 1KW			
	2.0 TDI	125		08.10		PR: 1KW			
	2.0 TDI	130		12.12		PR: 1KW			
	2.0 TDI 4motion	103		08.10		PR: 1KW			
	2.0 TDI 4motion	125		08.10		PR: 1KW			
	2.0 TDI 4motion	130		01.13		PR: 1KW			
	2.0 TSI	155		11.10		PR: 1KW			
	2.0 TSI 4motion	155		01.12		PR: 1KW			
3.6 FSI 4motion	220		01.11		PR: 1KW				
	1.4 TSI	90		08.10		PR: 2EA	G1020734	electric parking brake <sup>1)</sup>	23914 17,1 /WD/Acc/S LUC
	1.4 TSI	110		08.10		PR: 2EA			
	1.4 TSI	118		11.12		PR: 2EA			
	1.6 TDI	77		08.10		PR: 2EA			
	1.8 TSI	118		08.10		PR: 2EA			
	2.0 TDI			08.10		PR: 2EA			
	2.0 TDI	125		08.10		PR: 2EA			
	2.0 TDI	130		12.12		PR: 2EA			
	2.0 TDI 4motion	103		08.10		PR: 2EA			
	2.0 TDI 4motion	125		08.10		PR: 2EA			
	2.0 TDI 4motion	130		01.13		PR: 2EA			
	2.0 TSI	155		11.10		PR: 2EA			
	2.0 TSI 4motion	155		01.12		PR: 2EA			
3.6 FSI 4motion	220		01.11		PR: 2EA				
	1.4 TSI	90		08.10		PR: 1KW	G2112169	electric parking brake <sup>1)</sup>	282 12,0 10,0 +S +C
	1.4 TSI	110		08.10		PR: 1KW			
	1.4 TSI	118		11.12		PR: 1KW			
	1.6 TDI	77		08.10		PR: 1KW			
	1.8 TSI	118		08.10		PR: 1KW			
	2.0 TDI			08.10		PR: 1KW			
	2.0 TDI	125		08.10		PR: 1KW			
	2.0 TDI	130		12.12		PR: 1KW			
	2.0 TDI 4motion	103		08.10		PR: 1KW			
	2.0 TDI 4motion	125		08.10		PR: 1KW			
	2.0 TDI 4motion	130		01.13		PR: 1KW			
	2.0 TSI	155		11.10		PR: 1KW			
	2.0 TSI 4motion	155		01.12		PR: 1KW			
3.6 FSI 4motion	220		01.11		PR: 1KW				

<sup>1)</sup> fr.di stazionamento elettrico / frein à main électrique / freno de mano eléctrico / elektrische Feststellbremse

							
<b>VOLKSWAGEN PASSAT ALLTRACK (12-)</b>							
	1.8 TSI 1.8 TSI 2.0 TDI 2.0 TDI 4motion 2.0 TDI 4motion 2.0 TDI 4motion 2.0 TSI 4motion	112 118 103 103 125 130 155	01.12 01.12 01.12 01.12 01.12 01.13 01.12	PR: 1ZM,1ZG PR: 1ZM,1ZG PR: 1ZM,1ZG PR: 1ZM,1ZG PR: 1ZM,1ZG PR: 1ZM,1ZG PR: 1ZM,1ZG	G1020680		23587 20,6 +/WI ATE
	1.8 TSI 1.8 TSI 2.0 TDI 2.0 TDI 4motion 2.0 TDI 4motion 2.0 TDI 4motion 2.0 TSI 4motion	112 118 103 103 125 130 155	01.12 01.12 01.12 01.12 01.12 01.13 01.12	PR: 1ZM,1ZG PR: 1ZM,1ZG PR: 1ZM,1ZG PR: 1ZM,1ZG PR: 1ZM,1ZG PR: 1ZM,1ZG PR: 1ZM,1ZG	G2125158		312 25,0 22,0 V L +S +C
	1.8 TSI 1.8 TSI 2.0 TDI 2.0 TDI 4motion 2.0 TDI 4motion 2.0 TDI 4motion 2.0 TSI 4motion	112 118 103 103 125 130 155	01.12 01.12 01.12 01.12 01.12 01.13 01.12	PR: 1KW PR: 1KW PR: 1KW PR: 1KW PR: 1KW PR: 1KW PR: 1KW	G1020993	electric parking brake <sup>1)</sup>	24483 16,9 /Acc/S LUC
	1.8 TSI 1.8 TSI 2.0 TDI 2.0 TDI 4motion 2.0 TDI 4motion 2.0 TDI 4motion 2.0 TSI 4motion	112 118 103 103 125 130 155	01.12 01.12 01.12 01.12 01.12 01.13 01.12	PR: 2EA PR: 2EA PR: 2EA PR: 2EA PR: 2EA PR: 2EA PR: 2EA	G1020734	electric parking brake <sup>1)</sup>	23914 17,1 /WD/Acc/S LUC
	1.8 TSI 1.8 TSI 2.0 TDI 2.0 TDI 4motion 2.0 TDI 4motion 2.0 TDI 4motion 2.0 TSI 4motion	112 118 103 103 125 130 155	01.12 01.12 01.12 01.12 01.12 01.13 01.12	PR: 1KW PR: 1KW PR: 1KW PR: 1KW PR: 1KW PR: 1KW PR: 1KW	G2112169	electric parking brake <sup>1)</sup>	282 12,0 10,0 +S +C
<b>VOLKSWAGEN PHAETON (02-)</b>							
	3.0 TDI 4motion 3.0 V6 TDI 4motion 3.2 V6 3.2 V6 4motion 3.6 V6 4motion 4.2 V8 4motion 5.0 V10 TDI 4motion 6.0 W12 4motion	165	09.04 04.08 04.02 02.04 11.08 05.03 11.02 04.02	PR: 1ZK,1ZL PR: 1ZK,1ZL PR: 1ZK,1ZL PR: 1ZK,1ZL PR: 1ZK,1ZL PR: 1ZK,1ZL PR: 1ZK,1ZL PR: 1ZK,1ZL	G1020678		23896 20,6 +/WI ATE
	3.0 TDI 4motion 3.0 V6 TDI 4motion 3.2 V6 3.2 V6 4motion 3.6 V6 4motion 4.2 V8 4motion 5.0 V10 TDI 4motion 6.0 W12 4motion	165	09.04 04.08 04.02 02.04 11.08 05.03 11.02 04.02	PR: 1ZK,1ZL PR: 1ZK,1ZL PR: 1ZK,1ZL PR: 1ZK,1ZL PR: 1ZK,1ZL PR: 1ZK,1ZL PR: 1ZK,1ZL PR: 1ZK,1ZL	G2134100		360 34,0 31,0 V L +C
<b>VOLKSWAGEN POLO II (81-94)</b>							
	1.0 1.1 1.3		10.81 02.85 10.81 07.83 10.81 02.85		G1020097		20228 15,3 ATE
	1.0 1.3 1.3 D 1.4 D		03.85 09.94 03.85 09.94 08.86 09.90 08.90 09.94		G1020344		20887 17,3 +/Acc VW
	1.3 G40		01.87 09.94		G1020010		20887 15,3 +/Acc VW
	1.0 1.1 1.3 1.3 D 1.4 D		10.81 09.94 10.81 07.83 10.81 09.94 08.86 09.90 08.90 09.94		G2110151		239 10,0 8,0 +S +C
	1.3 G40		01.87 09.94		G2120123		239 20,0 18,0 V L +S +C
<b>VOLKSWAGEN POLO III (95-01)</b>							
	1.05 1.3 1.4 1.4 1.6 1.9 D 1.9 SDI		6N-TY140000 10.94 6N-TY140000 10.94 6N-TY140000 07.95 6N-TY140000 07.95 6N-TY140000 10.94 6N-TY140000 10.94 6N-TY140000 10.94		G1020344		20887 17,3 +/Acc VW
	1.05 1.3 1.4 1.4 1.6 1.9 D 1.9 SDI	40 44 55	6N-TW082000 10.94 6N-TW082000 10.94 6N-TW082000 07.95 6N-TW082000 07.95 6N-TW082000 10.94 6N-TW082000 10.94 6N-TW082000 10.94		G1020344		20887 17,3 +/Acc VW
	1.0		07.96 09.01		G1020408		21866 17,2 + VW

<sup>1)</sup> fr. di stazionamento elettrico / frein à main électrique / freno de mano eléctrico / elektrishe Feststellbremse



**VOLKSWAGEN POLO III (95-01)**

	1.05 1.3 1.4 1.4 1.4 16V 1.6 1.7 SDI 1.9 D 1.9 SDI	6N-TY140001 6N-TY140001 40 6N-TY140001 44 6N-TY140001 55 55 6N-TY140001  6N-TY140001 6N-TY140001		09.96 04.97 09.01 09.01 09.01 09.99 09.01 09.01 09.01			G1020408		21866 17,2 +	VW
	1.05 1.3 1.4 1.4 1.6 1.9 D 1.9 SDI	6N-TW082001 6N-TW082001 40 6N-TW082001 44 6N-TW082001 55 6N-TW082001 6N-TW082001 6N-TW082001		09.96 04.97 09.01 09.01 09.99 09.01 09.01			G1020408		21866 17,2 +	VW
	1.4 16V 1.4 16V 1.4 TDI 1.6 GTI	55 74 55		01.99 04.96 01.99 04.98	09.01 09.01 09.01 09.01	- ABS - motorsports <sup>1)</sup>	G1020444		21945 16,0 /S	LUC
	1.05 1.3 1.6 1.9 D 1.9 SDI	55	6N-SY087410 6N-SY087410 6N-SY087410 6N-SY087410 6N-SY087410	10.94 10.94 10.94 10.94 10.94			G2110232		239 9,9 8,0 +S +C	
	1.05 1.3 1.6 1.9 D 1.9 SDI	55	6N-SW008500 6N-SW008500 6N-SW008500 6N-SW008500 6N-SW008500	10.94 10.94 10.94 10.94 10.94			G2110232		239 9,9 8,0 +S +C	
	1.0 1.05 1.3 1.4 1.4 1.4 16V 1.6 1.7 SDI 1.9 D 1.9 SDI	6N-SY087411 6N-SY087411 40 44 55 55 6N-SY087411		07.96 09.01 04.97 07.95 09.01 07.95 09.01 01.99 09.01 09.99 05.97 09.01		- ABS	G2118106		239 18,0 16,0 V L +S +C	
	1.05 1.3 1.6 1.9 D 1.9 SDI	6N-SW008501 6N-SW008501 55 6N-SW008501 6N-SW008501 6N-SW008501		09.96 04.97 09.99 09.01 09.01			G2118106		239 18,0 16,0 V L +S +C	
	1.4 16V 1.4 16V 1.4 TDI	55 74 55		01.99 04.96 01.99	09.01 09.01 09.01	+ ABS	G2120128		256 20,0 18,0 V L +S +C	
	1.4 16V 1.6 GTI	74		04.96 04.98	09.99 09.99	+ ⊕ / - motorsports <sup>2)</sup>	G1020345		20961 17,0 /WD/Acc/S	LUC
	1.4 16V 1.4 16V 1.4 TDI 1.6 GTI	55 74 55		01.99 10.99 01.99 10.99	09.01 09.01 09.01 09.01	+ ABS + ⊕ / - motorsports <sup>2)</sup> + ABS	G1020755 G1020676		20961 17,1 /Acc/S 20961 15,8 /S	LUC LUC
	1.4 16V 1.6 GTI	74		04.96 04.98	09.99 09.99	+ ⊕	G2110111	without sensor ring <sup>3)</sup>	226 10,0 8,0 +C	
	1.4 16V 1.4 16V 1.4 TDI 1.6 GTI	55 74 55		01.99 10.99 01.99 10.99	09.01 09.01 09.01 09.01	+ ABS + ⊕ + ABS	G2109124		232 9,0 7,0 +C	

**VOLKSWAGEN POLO IV (02-09)**

	1.2 1.2 1.4 16V 1.4 16V 1.4 16V 1.4 FSI 1.4 TDI 1.6 16V 1.8 GTI 1.8 GTI 1.9 SDI 1.9 TDI 1.9 TDI 2.0	40 51 63 74   77 110 132  74 96 85		11.01 11.01 04.07 11.01 05.06 11.01 11.01 05.06 09.05 06.06 11.01 11.01 10.03 04.02	05.09 05.09 05.09 05.09 05.09 05.09 05.09 05.09 05.09 05.09 05.09 05.09 05.09 05.09 05.09	PR: 1LM,1ZN PR: 1LM,1ZN PR: 1LM,1ZN PR: 1LM,1ZN PR: 1LM,1ZN PR: 1LM,1ZN PR: 1LM,1ZN PR: 1LM,1ZN PR: 1LM,1ZN PR: 1LM,1ZN PR: 1LM,1ZN PR: 1LM,1ZN PR: 1LM,1ZN PR: 1LM,1ZN	G1020409 G1020408		21868 17,2 +/WI 21866 17,2 +	VW VW
	1.2 1.2 1.4 16V 1.4 16V 1.4 FSI 1.4 TDI	40 51 63 74		11.01 11.01 04.07 11.01 05.06 11.01	05.09 05.09 05.09 05.09 05.09 05.09	PR: 1LQ,1LR,1ZG PR: 1LQ,1LR,1ZG PR: 1LQ,1LR,1ZG PR: 1LQ,1LR,1ZG PR: 1LQ,1LR,1ZG PR: 1LQ,1LR,1ZG	G1020463		23131 19,7 +/WI	VW

1) - motorsports / - Motorsport / - motorismo / - Motorsport  
2) + ⊕ / - motorsports / + ⊕ / - Motorsport / + ⊕ / - motorismo / + ⊕ / - Motorsport  
3) senza sensori / sans secours ABS / sin anillo sensor ABS / ohne Sensoring





**VOLKSWAGEN POLO IV (02-09)**

	1.6 16V	77		05.06	05.09	PR: 1LQ,1LR,1ZG	G1020463		23131 19,7 +/Wl	VW
	1.8 GTI	110		09.05	05.09	PR: 1LQ,1LR,1ZG				
	1.8 GTI	132		06.06	05.09	PR: 1LQ,1LR,1ZG				
	1.9 SDI			11.01	05.09	PR: 1LQ,1LR,1ZG				
	1.9 TDI	74		11.01	05.09	PR: 1LQ,1LR,1ZG				
	1.9 TDI	96		10.03	05.09	PR: 1LQ,1LR,1ZG				
	2.0	85		04.02	05.09	PR: 1LQ,1LR,1ZG				
	1.2			11.01	05.09	PR: 1ZF				
	1.2	40		11.01	05.09	PR: 1ZF				
	1.2	51		04.07	05.09	PR: 1ZF				
1.4 16V			11.01	05.09	PR: 1ZF					
1.4 16V	63		05.06	05.09	PR: 1ZF					
1.4 16V	74		11.01	05.09	PR: 1ZF					
1.4 FSI			11.01	05.09	PR: 1ZF					
1.4 TDI			11.01	05.09	PR: 1ZF					
1.6 16V	77		05.06	05.09	PR: 1ZF					
1.8 GTI	110		09.05	05.09	PR: 1ZF					
1.8 GTI	132		06.06	05.09	PR: 1ZF					
1.9 SDI			11.01	05.09	PR: 1ZF					
1.9 TDI	74		11.01	05.09	PR: 1ZF					
1.9 TDI	96		10.03	05.09	PR: 1ZF					
2.0	85		04.02	05.09	PR: 1ZF					
1.2			11.01	05.09	PR: 1LN,1ZD,1ZH					
1.2	40		11.01	05.09	PR: 1LN,1ZD,1ZH					
1.2	51		04.07	05.09	PR: 1LN,1ZD,1ZH					
1.4 16V			11.01	05.09	PR: 1LN,1ZD,1ZH					
1.4 16V	63		05.06	05.09	PR: 1LN,1ZD,1ZH					
1.4 16V	74		11.01	05.09	PR: 1LN,1ZD,1ZH					
1.4 FSI			11.01	05.09	PR: 1LN,1ZD,1ZH					
1.4 TDI			11.01	05.09	PR: 1LN,1ZD,1ZH					
1.6 16V	77		05.06	05.09	PR: 1LN,1ZD,1ZH					
1.8 GTI	110		09.05	05.09	PR: 1LN,1ZD,1ZH					
1.8 GTI	132		06.06	05.09	PR: 1LN,1ZD,1ZH					
1.9 SDI			11.01	05.09	PR: 1LN,1ZD,1ZH					
1.9 TDI	74		11.01	05.09	PR: 1LN,1ZD,1ZH					
1.9 TDI	96		10.03	05.09	PR: 1LN,1ZD,1ZH					
2.0	85		04.02	05.09	PR: 1LN,1ZD,1ZH					
1.2			11.01	05.09	PR: 1LJ					
1.2	40		11.01	05.09	PR: 1LJ					
1.2	51		04.07	05.09	PR: 1LJ					
1.4 16V			11.01	05.09	PR: 1LJ					
1.4 16V	63		05.06	05.09	PR: 1LJ					
1.4 16V	74		11.01	05.09	PR: 1LJ					
1.4 FSI			11.01	05.09	PR: 1LJ					
1.4 TDI			11.01	05.09	PR: 1LJ					
1.6 16V	77		05.06	05.09	PR: 1LJ					
1.8 GTI	110		09.05	05.09	PR: 1LJ					
1.8 GTI	132		06.06	05.09	PR: 1LJ					
1.9 SDI			11.01	05.09	PR: 1LJ					
1.9 TDI	74		11.01	05.09	PR: 1LJ					
1.9 TDI	96		10.03	05.09	PR: 1LJ					
2.0	85		04.02	05.09	PR: 1LJ					
	1.2			11.01	05.09	PR: 1LM,1ZN	G2118137		239 18,0 16,0 V L +S +C	
	1.2	40		11.01	05.09	PR: 1LM,1ZN				
	1.2	51		04.07	05.09	PR: 1LM,1ZN				
	1.4 16V			11.01	05.09	PR: 1LM,1ZN				
	1.4 16V	63		05.06	05.09	PR: 1LM,1ZN				
	1.4 16V	74		11.01	05.09	PR: 1LM,1ZN				
	1.4 FSI			11.01	05.09	PR: 1LM,1ZN				
	1.4 TDI			11.01	05.09	PR: 1LM,1ZN				
	1.6 16V	77		05.06	05.09	PR: 1LM,1ZN				
	1.8 GTI	110		09.05	05.09	PR: 1LM,1ZN				
1.8 GTI	132		06.06	05.09	PR: 1LM,1ZN					
1.9 SDI			11.01	05.09	PR: 1LM,1ZN					
1.9 TDI	74		11.01	05.09	PR: 1LM,1ZN					
1.9 TDI	96		10.03	05.09	PR: 1LM,1ZN					
2.0	85		04.02	05.09	PR: 1LM,1ZN					
1.2			11.01	05.09	PR: 1LQ,1LR,1ZF,1ZG					
1.2	40		11.01	05.09	PR: 1LQ,1LR,1ZF,1ZG					
1.2	51		04.07	05.09	PR: 1LQ,1LR,1ZF,1ZG					
1.4 16V			11.01	05.09	PR: 1LQ,1LR,1ZF,1ZG					
1.4 16V	63		05.06	05.09	PR: 1LQ,1LR,1ZF,1ZG					
1.4 16V	74		11.01	05.09	PR: 1LQ,1LR,1ZF,1ZG					
1.4 FSI			11.01	05.09	PR: 1LQ,1LR,1ZF,1ZG					
1.4 TDI			11.01	05.09	PR: 1LQ,1LR,1ZF,1ZG					
1.6 16V	77		05.06	05.09	PR: 1LQ,1LR,1ZF,1ZG					
1.8 GTI	110		09.05	05.09	PR: 1LQ,1LR,1ZF,1ZG					
1.8 GTI	132		06.06	05.09	PR: 1LQ,1LR,1ZF,1ZG					
1.9 SDI			11.01	05.09	PR: 1LQ,1LR,1ZF,1ZG					
1.9 TDI	74		11.01	05.09	PR: 1LQ,1LR,1ZF,1ZG					
1.9 TDI	96		10.03	05.09	PR: 1LQ,1LR,1ZF,1ZG					
2.0	85		04.02	05.09	PR: 1LQ,1LR,1ZF,1ZG					
1.2			11.01	05.09	PR: 1LN,1ZD,1ZH					
1.2	40		11.01	05.09	PR: 1LN,1ZD,1ZH					
1.2	51		04.07	05.09	PR: 1LN,1ZD,1ZH					
1.4 16V			11.01	05.09	PR: 1LN,1ZD,1ZH					
1.4 16V	63		05.06	05.09	PR: 1LN,1ZD,1ZH					



**VOLKSWAGEN POLO IV (02-09)**

	1.4 16V	74		11.01	05.09	PR: 1LN,1ZD,1ZH	G2125113		288 25,0 22,0 V L +S +C
	1.4 FSI			11.01	05.09	PR: 1LN,1ZD,1ZH			
	1.4 TDI			11.01	05.09	PR: 1LN,1ZD,1ZH			
	1.6 16V	77		05.06	05.09	PR: 1LN,1ZD,1ZH			
	1.8 GTI	110		09.05	05.09	PR: 1LN,1ZD,1ZH			
	1.8 GTI	132		06.06	05.09	PR: 1LN,1ZD,1ZH			
	1.9 SDI			11.01	05.09	PR: 1LN,1ZD,1ZH			
	1.9 TDI	74		11.01	05.09	PR: 1LN,1ZD,1ZH			
	1.9 TDI	96		10.03	05.09	PR: 1LN,1ZD,1ZH			
	2.0	85		04.02	05.09	PR: 1LN,1ZD,1ZH			
	1.2			11.01	05.09	PR: 1LJ			
1.2	40		11.01	05.09	PR: 1LJ				
1.2	51		04.07	05.09	PR: 1LJ				
1.4 16V			11.01	05.09	PR: 1LJ				
1.4 16V	63		05.06	05.09	PR: 1LJ				
1.4 16V	74		11.01	05.09	PR: 1LJ				
1.4 FSI			11.01	05.09	PR: 1LJ				
1.4 TDI			11.01	05.09	PR: 1LJ				
1.6 16V	77		05.06	05.09	PR: 1LJ				
1.8 GTI	110		09.05	05.09	PR: 1LJ				
1.8 GTI	132		06.06	05.09	PR: 1LJ				
1.9 SDI			11.01	05.09	PR: 1LJ	G1020676 G1020549 G1020566		20961 15,8 /S 20961 17,1 /WD/S 23554 17,1 +/WI/S	LUC LUC LUC
1.2	40		11.01	05.09	PR: 1KD,1KS,1KV				
1.2	51		11.01	05.09	PR: 1KD,1KS,1KV				
1.2			04.07	05.09	PR: 1KD,1KS,1KV				
1.4 16V			11.01	05.09	PR: 1KD,1KS,1KV				
1.4 16V	63		05.06	05.09	PR: 1KD,1KS,1KV				
1.4 16V	74		11.01	05.09	PR: 1KD,1KS,1KV				
1.4 FSI			11.01	05.09	PR: 1KD,1KS,1KV				
1.4 TDI			11.01	05.09	PR: 1KD,1KS,1KV				
1.6 16V	77		05.06	05.09	PR: 1KD,1KS,1KV				
1.8 GTI	110		09.05	05.09	PR: 1KD,1KS,1KV				
1.8 GTI	132		06.06	05.09	PR: 1KD,1KS,1KV				
1.9 TDI	74		11.01	05.09	PR: 1KD,1KS,1KV				
1.9 TDI	96		10.03	05.09	PR: 1KD,1KS,1KV				
2.0	85		04.02	05.09	PR: 1KD,1KS,1KV				
1.2			11.01	05.09	PR: 1KK,1KT	G1020755		20961 17,1 /Acc/S	LUC
1.2	40		11.01	05.09	PR: 1KK,1KT				
1.2	51		04.07	05.09	PR: 1KK,1KT				
1.4 16V			11.01	05.09	PR: 1KK,1KT				
1.4 16V	63		05.06	05.09	PR: 1KK,1KT				
1.4 16V	74		11.01	05.09	PR: 1KK,1KT				
1.4 FSI			11.01	05.09	PR: 1KK,1KT				
1.4 TDI			11.01	05.09	PR: 1KK,1KT				
1.6 16V	77		05.06	05.09	PR: 1KK,1KT				
1.8 GTI	110		09.05	05.09	PR: 1KK,1KT				
1.8 GTI	132		06.06	05.09	PR: 1KK,1KT				
1.9 TDI	74		11.01	05.09	PR: 1KK,1KT				
1.9 TDI	96		10.03	05.09	PR: 1KK,1KT				
2.0	85		04.02	05.09	PR: 1KK,1KT				
	1.2			11.01	05.09	PR: 1KD,1KS,1KT,1KV	G2109123		230 9,0 7,0 +S +C
	1.2	40		11.01	05.09	PR: 1KD,1KS,1KT,1KV			
	1.2	51		04.07	05.09	PR: 1KD,1KS,1KT,1KV			
	1.4 16V			11.01	05.09	PR: 1KD,1KS,1KT,1KV			
	1.4 16V	63		05.06	05.09	PR: 1KD,1KS,1KT,1KV			
	1.4 16V	74		11.01	05.09	PR: 1KD,1KS,1KT,1KV			
	1.4 FSI			11.01	05.09	PR: 1KD,1KS,1KT,1KV			
	1.4 TDI			11.01	05.09	PR: 1KD,1KS,1KT,1KV			
	1.6 16V	77		05.06	05.09	PR: 1KD,1KS,1KT,1KV			
	1.8 GTI	110		09.05	05.09	PR: 1KD,1KS,1KT,1KV			
	1.8 GTI	132		06.06	05.09	PR: 1KD,1KS,1KT,1KV			
1.9 TDI	74		11.01	05.09	PR: 1KD,1KS,1KT,1KV				
1.9 TDI	96		10.03	05.09	PR: 1KD,1KS,1KT,1KV				
2.0	85		04.02	05.09	PR: 1KD,1KS,1KT,1KV				

**VOLKSWAGEN POLO V (09-)**

	1.2	44		03.09		PR: 1ZG,1LR,1ZJ	G1020331		23130 19,7 +	VW
	1.2	51		03.09		PR: 1ZG,1LR,1ZJ				
	1.2 TDI	55		10.09		PR: 1ZG,1LR,1ZJ				
	1.2 TSI	66		05.11		PR: 1ZG,1LR,1ZJ				
	1.2 TSI	77		06.09		PR: 1ZG,1LR,1ZJ				
	1.4	63		03.09		PR: 1ZG,1LR,1ZJ				
	1.4 BiFuel	60		03.10		PR: 1ZG,1LR,1ZJ				
	1.4 GTI	132		05.10		PR: 1ZG,1LR,1ZJ				
	1.4 TSI	103		10.12		PR: 1ZG,1LR,1ZJ				
	1.6 BiFuel	60		01.11		PR: 1ZG,1LR,1ZJ				
	1.6 TDI	55		03.09		PR: 1ZG,1LR,1ZJ				
	1.6 TDI	66		06.09		PR: 1ZG,1LR,1ZJ				
	1.6 TDI	77		06.09		PR: 1ZG,1LR,1ZJ				
	2.0 R WRC	162		08.13		PR: 1ZG,1LR,1ZJ				
1.2	44		03.09		PR: 1LN,1ZC,1ZD	G1020680		23587 20,6 +/WI	ATE	
1.2	51		03.09		PR: 1LN,1ZC,1ZD					
1.2 TDI	55		10.09		PR: 1LN,1ZC,1ZD					
1.2 TSI	66		05.11		PR: 1LN,1ZC,1ZD					







**VOLKSWAGEN POLO V (09-)**

	1.2 TSI	77		<b>06.09</b>	PR: 1LN,1ZC,1ZD	<b>G1020680</b>		23587 20,6 +/Wl	<b>ATE</b>				
	1.4	63		<b>03.09</b>	PR: 1LN,1ZC,1ZD								
	1.4 BiFuel	60		<b>03.10</b>	PR: 1LN,1ZC,1ZD								
	1.4 GTI	132		<b>05.10</b>	PR: 1LN,1ZC,1ZD								
	1.4 TSI	103		<b>10.12</b>	PR: 1LN,1ZC,1ZD								
	1.6 BiFuel	60		<b>01.11</b>	PR: 1LN,1ZC,1ZD								
	1.6 TDI	55		<b>03.09</b>	PR: 1LN,1ZC,1ZD								
	1.6 TDI	66		<b>06.09</b>	PR: 1LN,1ZC,1ZD								
	1.6 TDI	77		<b>06.09</b>	PR: 1LN,1ZC,1ZD								
	2.0 R WRC	162		<b>08.13</b>	PR: 1LN,1ZC,1ZD								
	1.2	44		<b>03.09</b>	PR: 1LR,1ZG,1ZJ	<b>G2122151</b>		256 22,0 19,0 V L +S +C					
	1.2	51		<b>03.09</b>	PR: 1LR,1ZG,1ZJ								
	1.2 TDI	55		<b>10.09</b>	PR: 1LR,1ZG,1ZJ								
	1.2 TSI	66		<b>05.11</b>	PR: 1LR,1ZG,1ZJ								
	1.2 TSI	77		<b>06.09</b>	PR: 1LR,1ZG,1ZJ								
	1.4	63		<b>03.09</b>	PR: 1LR,1ZG,1ZJ								
	1.4 BiFuel	60		<b>03.10</b>	PR: 1LR,1ZG,1ZJ								
	1.4 GTI	132		<b>05.10</b>	PR: 1LR,1ZG,1ZJ								
	1.4 TSI	103		<b>10.12</b>	PR: 1LR,1ZG,1ZJ								
	1.6 BiFuel	60		<b>01.11</b>	PR: 1LR,1ZG,1ZJ								
	1.6 TDI	55		<b>03.09</b>	PR: 1LR,1ZG,1ZJ								
	1.6 TDI	66		<b>06.09</b>	PR: 1LR,1ZG,1ZJ								
	1.6 TDI	77		<b>06.09</b>	PR: 1LR,1ZG,1ZJ								
	2.0 R WRC	162		<b>06.09</b>	PR: 1LR,1ZG,1ZJ								
	1.2	44		<b>03.09</b>	PR: 1LN,1ZC,1ZD					<b>G2125113</b>		288 25,0 22,0 V L +S +C	
	1.2	51		<b>03.09</b>	PR: 1LN,1ZC,1ZD								
	1.2 TDI	55		<b>10.09</b>	PR: 1LN,1ZC,1ZD								
	1.2 TSI	66		<b>05.11</b>	PR: 1LN,1ZC,1ZD								
	1.2 TSI	77		<b>06.09</b>	PR: 1LN,1ZC,1ZD								
	1.4	63		<b>03.09</b>	PR: 1LN,1ZC,1ZD								
1.4 BiFuel	60		<b>03.10</b>	PR: 1LN,1ZC,1ZD									
1.4 GTI	132		<b>05.10</b>	PR: 1LN,1ZC,1ZD									
1.4 TSI	103		<b>10.12</b>	PR: 1LN,1ZC,1ZD									
1.6 BiFuel	60		<b>01.11</b>	PR: 1LN,1ZC,1ZD									
1.6 TDI	55		<b>03.09</b>	PR: 1LN,1ZC,1ZD									
1.6 TDI	66		<b>06.09</b>	PR: 1LN,1ZC,1ZD									
1.6 TDI	77		<b>06.09</b>	PR: 1LN,1ZC,1ZD									
2.0 R WRC	162		<b>08.13</b>	PR: 1LN,1ZC,1ZD									
1.2	44		<b>03.09</b>	PR: 1ZP,1ZR	<b>G2125123</b>		310 25,0 22,0 V L +C						
1.2	51		<b>03.09</b>	PR: 1ZP,1ZR									
1.2 TDI	55		<b>10.09</b>	PR: 1ZP,1ZR									
1.2 TSI	66		<b>05.11</b>	PR: 1ZP,1ZR									
1.2 TSI	77		<b>06.09</b>	PR: 1ZP,1ZR									
1.4	63		<b>03.09</b>	PR: 1ZP,1ZR									
1.4 BiFuel	60		<b>03.10</b>	PR: 1ZP,1ZR									
1.4 GTI	132		<b>05.10</b>	PR: 1ZP,1ZR									
1.4 TSI	103		<b>10.12</b>	PR: 1ZP,1ZR									
1.6 BiFuel	60		<b>01.11</b>	PR: 1ZP,1ZR									
1.6 TDI	55		<b>03.09</b>	PR: 1ZP,1ZR									
1.6 TDI	66		<b>06.09</b>	PR: 1ZP,1ZR									
1.6 TDI	77		<b>06.09</b>	PR: 1ZP,1ZR									
2.0 R WRC	162		<b>08.13</b>	PR: 1ZP,1ZR									
	1.2	44		<b>03.09</b>					PR: 1KK,1KT,1KV	<b>G1020492</b>		23554 17,1 /WD/S	<b>LUC</b>
	1.2	51		<b>03.09</b>					PR: 1KK,1KT,1KV				
	1.2 TDI	55		<b>10.09</b>					PR: 1KK,1KT,1KV				
	1.2 TSI	66		<b>05.11</b>					PR: 1KK,1KT,1KV				
	1.2 TSI	77		<b>06.09</b>					PR: 1KK,1KT,1KV				
	1.4	63		<b>03.09</b>					PR: 1KK,1KT,1KV				
	1.4 BiFuel	60		<b>03.10</b>	PR: 1KK,1KT,1KV								
	1.4 GTI	132		<b>05.10</b>	PR: 1KK,1KT,1KV								
	1.4 TSI	103		<b>10.12</b>	PR: 1KK,1KT,1KV								
	1.6 BiFuel	60		<b>01.11</b>	PR: 1KK,1KT,1KV								
	1.6 TDI	55		<b>03.09</b>	PR: 1KK,1KT,1KV								
	1.6 TDI	66		<b>06.09</b>	PR: 1KK,1KT,1KV								
	1.6 TDI	77		<b>06.09</b>	PR: 1KK,1KT,1KV								
	2.0 R WRC	162		<b>08.13</b>	PR: 1KK,1KT,1KV								
	1.2	44		<b>03.09</b>	PR: 2EJ	<b>G1020755</b>		20961 17,1 /Acc/S	<b>LUC</b>				
	1.2	51		<b>03.09</b>	PR: 2EJ								
	1.2 TDI	55		<b>10.09</b>	PR: 2EJ								
	1.2 TSI	66		<b>05.11</b>	PR: 2EJ								
	1.2 TSI	77		<b>06.09</b>	PR: 2EJ								
	1.4	63		<b>03.09</b>	PR: 2EJ								
1.4 BiFuel	60		<b>03.10</b>	PR: 2EJ									
1.4 GTI	132		<b>05.10</b>	PR: 2EJ									
1.4 TSI	103		<b>10.12</b>	PR: 2EJ									
1.6 BiFuel	60		<b>01.11</b>	PR: 2EJ									
1.6 TDI	55		<b>03.09</b>	PR: 2EJ									
1.6 TDI	66		<b>06.09</b>	PR: 2EJ									
1.6 TDI	77		<b>06.09</b>	PR: 2EJ									
2.0 R WRC	162		<b>08.13</b>	PR: 2EJ									
	1.2	44		<b>03.09</b>	PR: 1KK,1KT,1KV,2EJ					<b>G2109123</b>		230 9,0 7,0 +S +C	
	1.2	51		<b>03.09</b>	PR: 1KK,1KT,1KV,2EJ								
	1.2 TDI	55		<b>10.09</b>	PR: 1KK,1KT,1KV,2EJ								
	1.2 TSI	66		<b>05.11</b>	PR: 1KK,1KT,1KV,2EJ								
	1.2 TSI	77		<b>06.09</b>	PR: 1KK,1KT,1KV,2EJ								
	1.4	63		<b>03.09</b>	PR: 1KK,1KT,1KV,2EJ								
	1.4 BiFuel	60		<b>03.10</b>	PR: 1KK,1KT,1KV,2EJ								
	1.4 GTI	132		<b>05.10</b>	PR: 1KK,1KT,1KV,2EJ								



### VOLKSWAGEN POLO V (09-)

	1.4 TSI	103		10.12	PR: 1KK,1KT,1KV,2EJ	G2109123		230 9,0 7,0 +S +C
	1.6 BiFuel	60		01.11	PR: 1KK,1KT,1KV,2EJ			
	1.6 TDI	55		03.09	PR: 1KK,1KT,1KV,2EJ			
	1.6 TDI	66		06.09	PR: 1KK,1KT,1KV,2EJ			
	1.6 TDI	77		06.09	PR: 1KK,1KT,1KV,2EJ			
	2.0 R WRC	162		08.13	PR: 1KK,1KT,1KV,2EJ	G2109123		230 9,0 7,0 +S +C

### VOLKSWAGEN POLO Classic (96-01)

	1.4		6K-V-022628	12.95	- ABS	G1020344		20887 17,3 +/Acc	VW
	1.4		6K-V-022628	12.95	+ ABS	G1020355		21866 19,7 +	VW
	1.6	55	6K-V-022628	05.96					
	1.7 SDI		6K-V-022628	07.97					
	1.9 SDI		6K-V-022628	12.95					
	1.4		6K-V-022629	09.01		G1020390		21866 15,3 +	VW
	1.6	55	6K-V-022629	09.01					
	1.7 SDI		6K-V-022629	09.01					
	1.9 SDI		6K-V-022629	09.01					
	1.6	55		05.96	09.01	G1020444		21945 16,0 /S	LUC
	1.6	74		05.96	09.01				
	1.8			03.98	09.01 + MEX				
	1.9 TDI	66		09.96	09.01				
	1.9 TDI	81		06.98	09.01				
	2.0	85		03.99	09.01 + MEX				
	1.4		6K-V-022628	12.95	- ABS	G2110151		239 10,0 8,0 +S +C	
	1.4		6K-V-022628	12.95	+ ABS	G2112106		239 12,0 10,0 +S +C	
	1.6	55	6K-V-022628	05.96					
	1.7 SDI		6K-V-022628	07.97					
	1.9 SDI		6K-V-022628	12.95					
	1.4		6K-V-022629	09.01		G2120123		239 20,0 18,0 V L +S +C	
	1.6	55	6K-V-022629	09.01					
	1.7 SDI		6K-V-022629	09.01					
	1.9 SDI		6K-V-022629	09.01					
	1.6	55		05.96	09.01	G2120128		256 20,0 18,0 V L +S +C	
	1.6	74		05.96	09.01				
	1.8			03.98	09.01 + MEX				
	1.9 TDI	66		09.96	09.01				
	1.9 TDI	81		06.98	09.01				
	2.0	85		03.99	09.01 + MEX				
	1.9 TDI	81		06.98	09.99 - ABS	G1020201		20961 15,2 /WD/Acc/S	LUC
	1.9 TDI	81		06.98	09.99 + ABS	G1020345		20961 17,0 /WD/Acc/S	LUC
	1.9 TDI	81		10.99	09.01	G1020755		20961 17,1 /Acc/S	LUC
						G1020676		20961 15,8 /S	LUC
	1.9 TDI	81		06.98	09.99	G2110111	without sensor ring <sup>1)</sup>	226 10,0 8,0 +C	
	1.9 TDI	81		10.99	09.01	G2109124		232 9,0 7,0 +C	

### VOLKSWAGEN POLO Variant (97-01)

	1.4		6K-V-022628	03.97	- ABS	G1020344		20887 17,3 +/Acc	VW
	1.4		6K-V-022628	03.97	+ ABS	G1020355		21866 19,7 +	VW
	1.6	55	6K-V-022628	05.97					
	1.7 SDI		6K-V-022628	08.97					
	1.9 SDI		6K-V-022628	03.97					
	1.4		6K-V-022629	09.01		G1020390		21866 15,3 +	VW
	1.6	55	6K-V-022629	09.01					
	1.7 SDI		6K-V-022629	09.01					
	1.9 SDI		6K-V-022629	09.01					
	1.6	74		05.97	09.01	G1020444		21945 16,0 /S	LUC
	1.8			05.97	09.01				
	1.9 TDI	66		01.97	09.01				
	1.9 TDI	81		06.98	09.01				
	1.4		6K-V-022628	03.97	- ABS	G2110151		239 10,0 8,0 +S +C	
	1.4		6K-V-022628	03.97	+ ABS	G2112106		239 12,0 10,0 +S +C	
	1.6	55	6K-V-022628	05.97					
	1.7 SDI		6K-V-022628	08.97					
	1.9 SDI		6K-V-022628	03.97					
	1.4		6K-V-022629	09.01		G2120123		239 20,0 18,0 V L +S +C	
	1.6	55	6K-V-022629	09.01					
	1.7 SDI		6K-V-022629	09.01					
	1.9 SDI		6K-V-022629	09.01					
	1.6	74		05.97	09.01	G2120128		256 20,0 18,0 V L +S +C	
	1.8			05.97	09.01				
	1.9 TDI	66		01.97	09.01				
	1.9 TDI	81		06.98	09.01				
	1.9 TDI	81		06.98	09.01	G1020755		20961 17,1 /Acc/S	LUC
						G1020676		20961 15,8 /S	LUC
	1.9 TDI	81		06.98	09.01	G2109124		232 9,0 7,0 +C	

<sup>1)</sup> senza sensori / sans secours ABS / sin anillo sensor ABS / ohne Sensoring





**VOLKSWAGEN SCIROCCO (08-)**

	1.4 TSI	90		09.08	PR: 1LJ,1ZA,1ZB,1ZD,1ZE,1ZP	G1020680		23587 20,6 +/Wl	ATE
	1.4 TSI	118		08.08	PR: 1LJ,1ZA,1ZB,1ZD,1ZE,1ZP				
	2.0 R	195		11.09	PR: 1LJ,1ZA,1ZB,1ZD,1ZE,1ZP				
	2.0 TDI	103		10.08	PR: 1LJ,1ZA,1ZB,1ZD,1ZE,1ZP				
	2.0 TDI	125		05.09	PR: 1LJ,1ZA,1ZB,1ZD,1ZE,1ZP				
	2.0 TDI	130		01.13	PR: 1LJ,1ZA,1ZB,1ZD,1ZE,1ZP				
	2.0 TSI			08.08	PR: 1LJ,1ZA,1ZB,1ZD,1ZE,1ZP				
	1.4 TSI	90		09.08	PR: 1ZK	G1020895		23801 20,3 +/Wl	ATE
	1.4 TSI	118		08.08	PR: 1ZK				
	2.0 R	195		11.09	PR: 1ZK				
	2.0 TDI	103		10.08	PR: 1ZK				
	2.0 TDI	125		05.09	PR: 1ZK				
	2.0 TDI	130		01.13	PR: 1ZK				
	2.0 TSI			08.08	PR: 1ZK				
	1.4 TSI	90		09.08	PR: 1ZE,1ZP	G2125145		288 25,0 22,0 V L +S +C	
	1.4 TSI	118		08.08	PR: 1ZE,1ZP				
	2.0 R	195		11.09	PR: 1ZE,1ZP				
	2.0 TDI	103		10.08	PR: 1ZE,1ZP				
	2.0 TDI	125		05.09	PR: 1ZE,1ZP				
	2.0 TDI	130		01.13	PR: 1ZE,1ZP				
	2.0 TSI			08.08	PR: 1ZE,1ZP				
	1.4 TSI	90		09.08	PR: 1LJ,1ZA,1ZB,1ZD	G2125158		312 25,0 22,0 V L +S +C	
	1.4 TSI	118		08.08	PR: 1LJ,1ZA,1ZB,1ZD				
	2.0 R	195		11.09	PR: 1LJ,1ZA,1ZB,1ZD				
	2.0 TDI	103		10.08	PR: 1LJ,1ZA,1ZB,1ZD				
	2.0 TDI	125		05.09	PR: 1LJ,1ZA,1ZB,1ZD				
	2.0 TDI	130		01.13	PR: 1LJ,1ZA,1ZB,1ZD				
	2.0 TSI			08.08	PR: 1LJ,1ZA,1ZB,1ZD				
	1.4 TSI	90		09.08	PR: 1ZK	G2130115		345 30,0 27,0 V L +C	
	1.4 TSI	118		08.08	PR: 1ZK				
	2.0 R	195		11.09	PR: 1ZK				
	2.0 TDI	103		10.08	PR: 1ZK				
	2.0 TDI	125		05.09	PR: 1ZK				
	2.0 TDI	130		01.13	PR: 1ZK				
	2.0 TSI			08.08	PR: 1ZK				
	1.4 TSI	90		09.08	PR: 1KD	G1020492		23554 17,1 /WD/S	LUC
	1.4 TSI	118		08.08	PR: 1KD				
	2.0 R	195		11.09	PR: 1KD				
	2.0 TDI	103		10.08	PR: 1KD				
	2.0 TDI	125		05.09	PR: 1KD				
	2.0 TDI	130		01.13	PR: 1KD				
	2.0 TSI			08.08	PR: 1KD				
	1.4 TSI	90		09.08	PR: 1KE,1KW	G1020682		23914 17,1 /WD/Acc/S	LUC
	1.4 TSI	118		08.08	PR: 1KE,1KW				
	2.0 R	195		11.09	PR: 1KE,1KW				
	2.0 TDI	103		10.08	PR: 1KE,1KW				
	2.0 TDI	125		05.09	PR: 1KE,1KW				
	2.0 TDI	130		01.13	PR: 1KE,1KW				
	2.0 TSI			08.08	PR: 1KE,1KW				
	1.4 TSI	90		09.08	PR: 1KD	G2110277		253 10,0 8,0 +S +C	
	1.4 TSI	118		08.08	PR: 1KD				
	2.0 R	195		11.09	PR: 1KD				
	2.0 TDI	103		10.08	PR: 1KD				
	2.0 TDI	125		05.09	PR: 1KD				
	2.0 TDI	130		01.13	PR: 1KD				
	2.0 TSI			08.08	PR: 1KD				
	1.4 TSI	90		09.08	PR: 1KE	G2112158		256 12,0 10,0 +C	
	1.4 TSI	118		08.08	PR: 1KE				
	2.0 R	195		11.09	PR: 1KE				
	2.0 TDI	103		10.08	PR: 1KE				
	2.0 TDI	125		05.09	PR: 1KE				
	2.0 TDI	130		01.13	PR: 1KE				
	2.0 TSI			08.08	PR: 1KE				
	1.4 TSI	90		09.08	PR: 1KS,1KT	G2110356		272 9,7 8,0 +S +C	
	1.4 TSI	118		08.08	PR: 1KS,1KT				
	2.0 R	195		11.09	PR: 1KS,1KT				
	2.0 TDI	103		10.08	PR: 1KS,1KT				
	2.0 TDI	125		05.09	PR: 1KS,1KT				
	2.0 TDI	130		01.13	PR: 1KS,1KT				
	2.0 TSI			08.08	PR: 1KS,1KT				

**VOLKSWAGEN SHARAN I (95-10)**

	1.8 T	110	7M-W-070000	09.97		G1020312 G1020557		21624 20,3 + 21849 19,8 +/Wl	ATE ATE
	1.9 TDI	66	7M-W-070000	09.95					
	1.9 TDI	81	7M-W-070000	09.96					
	2.0	85	7M-W-070000	09.95					
	2.8 VR6	128	7M-W-070000	09.95					
	2.8 VR6 Syncro	128	7M-W-070000	11.96					
	1.8 T	110	7M-X-000001	7M-1-070000					
1.9 TDI	66	7M-X-000001	7M-1-070000						
1.9 TDI	81	7M-X-000001	7M-1-070000						
1.9 TDI	85	7M-X-000001	7M-1-070000	05.00					
2.0	85	7M-X-000001	7M-1-070000						
2.0 TDI			7M-1-070000	11.05					
2.8 VR6	128	7M-X-000001	7M-Y-050000						
2.8 VR6 Syncro	128	7M-X-000001	7M-Y-050000						



### VOLKSWAGEN SHARAN I (95-10)

	1.9 TDI	66	7M-2-000001		06.10	G1020593		23418 19,4 +/Wl	ATE
	1.9 TDI	85	7M-2-000001		06.10				
	1.9 TDI	96		11.02	06.10				
	2.0	85	7M-2-000001		06.10				
	2.0 TDI		7M-2-000001		06.10				
	1.8 T	110	7M-2-000001		06.10	G1020580		23269 19,8 +/Wl	ATE
	1.9 TDI	110		06.05	06.10				
	1.9 TDI 4motion	85		05.00	06.10				
	2.8 V6 24V	150		04.00	06.10				
	2.8 V6 24V 4motion	150		04.00	06.10				
	2.8 VR6	128	7M-1-000001		06.10				
	2.8 VR6 Syncro	128	7M-1-000001		06.10				
	1.8 T	110	7M-1-070000	09.97		G2125114		288 25,1 21,0 V L +S +C	
	1.9 TDI	66	7M-1-070000	09.95					
	1.9 TDI	81		09.96	04.00				
	1.9 TDI	85	7M-1-070000	05.00					
	2.0	85	7M-1-070000	09.95					
	2.8 VR6	128		09.95	04.00				
	2.8 VR6 Syncro	128		11.96	04.00				
	1.8 T	110		09.97	04.00	G1020549		20961 17,1 /WD/S	LUC
	1.9 TDI	66		09.95	04.00				
	1.9 TDI	81		09.96	04.00				
	2.0	85		09.95	04.00				
	2.8 VR6	128		09.95	04.00				
	2.8 VR6 Syncro	128		11.96	04.00				
		1.8 T	110	7M-1-070000	05.00				
1.9 TDI		66		05.00	06.10				
1.9 TDI		85		05.00	06.10				
1.9 TDI		96		11.02	06.10				
2.0		85		05.00	06.10				
2.0 TDI				11.05	06.10				
		1.8 T	110	7M-2-000001		06.10	G1020654		23446 16,5 +/Wl/Acc/S
	1.9 TDI	110		06.05	06.10				
	1.9 TDI 4motion	85		05.00	06.10				
	2.8 V6 24V	150		04.00	06.10				
	2.8 V6 24V 4motion	150		04.00	06.10				
	1.8 T	110	7M-1-070000	09.97		G2110223		268 10,0 8,0 +S +C	
	1.9 TDI	66		09.95	06.10				
	1.9 TDI	81		09.96	04.00				
	1.9 TDI	85		05.00	06.10				
	1.9 TDI	96		11.02	06.10				
	2.0	85		09.95	06.10				
	2.0 TDI			11.05	06.10				
	2.8 VR6	128		09.95	04.00				
	2.8 VR6 Syncro	128		11.96	04.00				

### VOLKSWAGEN SHARAN II (10-)

	1.4 TSI	110		07.10	PR: 1LJ	G1020992		24332 19,8 +/Wl	ATE
	1.8 TSI	118		05.12	PR: 1LJ				
	2.0 TDI	100		07.10	PR: 1LJ				
	2.0 TDI	125		07.10	PR: 1LJ				
	2.0 TDI	130		01.13	PR: 1LJ				
	2.0 TDI 4motion	100		05.11	PR: 1LJ				
	2.0 TSI	147		10.10	PR: 1LJ				
	1.4 TSI	110		07.10	PR: 1LJ	G2125158		312 25,0 22,0 V L +S +C	
	1.8 TSI	118		05.12	PR: 1LJ				
	2.0 TDI	100		07.10	PR: 1LJ				
	2.0 TDI	125		07.10	PR: 1LJ				
	2.0 TDI	130		01.13	PR: 1LJ				
	2.0 TDI 4motion	100		05.11	PR: 1LJ				
	2.0 TSI	147		10.10	PR: 1LJ				
	1.4 TSI	110		07.10		G1020993	electric parking brake <sup>1)</sup>	24483 16,9 /Acc/S	LUC
	1.8 TSI	118		05.12					
	2.0 TDI	100		07.10					
	2.0 TDI	125		07.10					
	2.0 TDI	130		01.13					
	2.0 TDI 4motion	100		05.11					
	2.0 TSI	147		10.10					
	1.4 TSI	110		07.10		G2112169	electric parking brake <sup>1)</sup>	282 12,0 10,0 +S +C	
	1.8 TSI	118		05.12					
	2.0 TDI	100		07.10					
	2.0 TDI	125		07.10					
	2.0 TDI	130		01.13					
	2.0 TDI 4motion	100		05.11					
	2.0 TSI	147		10.10					

### VOLKSWAGEN TIGUAN (07-)

	1.4 TSI			11.07	PR: 1LJ,1ZD	G1020992		24332 19,8 +/Wl	ATE
	1.4 TSI	90		08.10	PR: 1LJ,1ZD				
	1.4 TSI 4motion			09.07	PR: 1LJ,1ZD				
	2.0 TDI	81		04.10	PR: 1LJ,1ZD				
	2.0 TDI	103		03.08	PR: 1LJ,1ZD				
	2.0 TDI 4motion			01.08	PR: 1LJ,1ZD				
	2.0 TDI 4motion			11.07	PR: 1LJ,1ZD				
	2.0 TFSI 4motion			02.08	PR: 1LJ,1ZD				
	2.0 TSI 4motion			11.07	PR: 1LJ,1ZD				

<sup>1)</sup> fr. di stazionamento elettrico / frein à main électrique / freno de mano eléctrico / elektrische Feststellbremse



**VOLKSWAGEN TIGUAN (07-)**

	1.4 TSI	90	11.07	PR: 1LJ,1ZD	G2125158		312 25,0 22,0 V L +S +C
	1.4 TSI		08.10	PR: 1LJ,1ZD			
	1.4 TSI 4motion		09.07	PR: 1LJ,1ZD			
	2.0 TDI	81	04.10	PR: 1LJ,1ZD			
	2.0 TDI	103	03.08	PR: 1LJ,1ZD			
	2.0 TDI 4motion		01.08	PR: 1LJ,1ZD			
	2.0 TDI 4motion		11.07	PR: 1LJ,1ZD			
	2.0 TFSI 4motion		02.08	PR: 1LJ,1ZD			
2.0 TSI 4motion		11.07	PR: 1LJ,1ZD				
	1.4 TSI	90	11.07		G1020993		24483 16,9 /Acc/S LUC
	1.4 TSI		08.10				
	1.4 TSI 4motion		09.07				
	2.0 TDI	81	04.10				
	2.0 TDI	103	03.08				
	2.0 TDI 4motion		01.08				
	2.0 TDI 4motion		11.07				
	2.0 TFSI 4motion		02.08				
2.0 TSI 4motion		11.07					
	1.4 TSI	90	11.07		G2112169		282 12,0 10,0 +S +C
	1.4 TSI		08.10				
	1.4 TSI 4motion		09.07				
	2.0 TDI	81	04.10				
	2.0 TDI	103	03.08				
	2.0 TDI 4motion		01.08				
	2.0 TDI 4motion		11.07				
	2.0 TFSI 4motion		02.08				
2.0 TSI 4motion		11.07					

**VOLKSWAGEN TOUAREG I (03-10)**

	2.5 R5 TDI		01.03	03.10 PR: 1LB	G1020704		23835 19,6 +/WI ATE			
	3.0 V6 TDI		11.04	03.10 PR: 1LB						
	3.0 V6 TDI	176	10.07	03.10 PR: 1LB						
	3.2 V6		11.02	12.05 PR: 1LB						
	3.6 V6 FSI	206	01.06	03.10 PR: 1LB						
	4.2 V8	228	12.02	11.06 PR: 1LB						
	4.2 V8 FSI	257	12.06	03.10 PR: 1LB						
	5.0 TDI R50	258	01.08	03.10 PR: 1LB						
	5.0 V10 TDI	230	11.02	03.10 PR: 1LB						
	6.0 W12	331	08.04	11.06 PR: 1LB						
	2.5 R5 TDI		01.06	03.10 PR: 1LE				G1201010		24098 17,1 /WD BRE
	3.0 V6 TDI		01.06	03.10 PR: 1LE						
3.0 V6 TDI	176	10.07	03.10 PR: 1LE							
3.2 V6		11.02	12.05 PR: 1LE							
3.6 V6 FSI	206	01.06	03.10 PR: 1LE							
4.2 V8	228	01.06	11.06 PR: 1LE							
4.2 V8 FSI	257	12.06	03.10 PR: 1LE							
5.0 TDI R50	258	01.08	03.10 PR: 1LE							
5.0 V10 TDI	230	01.06	03.10 PR: 1LE							
6.0 W12	331	01.06	11.06 PR: 1LE							
2.5 R5 TDI		01.03	03.10 PR: 1LC	G1020709		23692 16,6 /WD BRE				
3.0 V6 TDI		11.04	03.10 PR: 1LC							
3.2 V6		11.02	12.05 PR: 1LC							
3.6 V6 FSI	206	01.06	03.10 PR: 1LC							
4.2 V8	228	12.02	11.06 PR: 1LC							
4.2 V8 FSI	257	12.06	03.10 PR: 1LC							
5.0 TDI R50	258	01.08	03.10 PR: 1LC							
5.0 V10 TDI	230	11.02	03.10 PR: 1LC							
6.0 W12	331	08.04	11.06 PR: 1LC							
2.5 R5 TDI		01.03	03.10 PR: 1LF				G1020710		23693 16,6 /WD BRE	
3.0 V6 TDI		11.04	03.10 PR: 1LF							
3.0 V6 TDI	176	10.07	03.10 PR: 1LF							
3.2 V6		11.02	12.05 PR: 1LF							
3.6 V6 FSI	206	01.06	03.10 PR: 1LF							
4.2 V8	228	12.02	11.06 PR: 1LF							
4.2 V8 FSI	257	12.06	03.10 PR: 1LF							
5.0 TDI R50	258	01.08	03.10 PR: 1LF							
5.0 V10 TDI	230	11.02	03.10 PR: 1LF							
6.0 W12	331	08.04	11.06 PR: 1LF							
2.5 R5 TDI		01.03	03.10 PR: 1LT,1LU	G1201079		24553 15,8 /WD BRE				
3.0 V6 TDI		11.04	03.10 PR: 1LT,1LU							
3.0 V6 TDI	176	10.07	03.10 PR: 1LT,1LU							
3.6 V6 FSI	206	01.06	03.10 PR: 1LT,1LU							
4.2 V8 FSI	257	12.06	03.10 PR: 1LT,1LU							
5.0 TDI R50	258	01.08	03.10 PR: 1LT,1LU							
5.0 V10 TDI	230	11.02	03.10 PR: 1LT,1LU							
6.0 W12	331	08.04	11.06 PR: 1LT,1LU							
	2.5 R5 TDI		01.03				03.10 PR: 1LB	G2130114		308 29,5 25,5 V L +C
	3.0 V6 TDI		11.04				03.10 PR: 1LB			
	3.0 V6 TDI	176	10.07				03.10 PR: 1LB			
	3.2 V6		11.02				12.05 PR: 1LB			
	3.6 V6 FSI	206	01.06	03.10 PR: 1LB						
	4.2 V8	228	12.02	11.06 PR: 1LB						
	4.2 V8 FSI	257	12.06	03.10 PR: 1LB						
	5.0 TDI R50	258	01.08	03.10 PR: 1LB						
	5.0 V10 TDI	230	11.02	03.10 PR: 1LB						
	6.0 W12	331	08.04	11.06 PR: 1LB						



### VOLKSWAGEN TOUAREG I (03-10)

	2.5 R5 TDI		01.03	03.10	PR: 1KE	G1020698		24367 19,1 +/WI	ATE
	3.0 V6 TDI		11.04	03.10	PR: 1KE				
	3.0 V6 TDI	176	10.07	03.10	PR: 1KE				
	3.2 V6		11.02	12.05	PR: 1KE				
	3.6 V6 FSI	206	01.06	03.10	PR: 1KE				
	4.2 V8	228	12.02	11.06	PR: 1KE				
	4.2 V8 FSI	257	12.06	03.10	PR: 1KE				
	5.0 TDI R50	258	01.08	03.10	PR: 1KE				
	5.0 V10 TDI	230	11.02	03.10	PR: 1KE				
	6.0 W12	331	08.04	11.06	PR: 1KE				
	2.5 R5 TDI		01.06	03.10	PR: 1KQ	G1201011		24097 17,1 /WD	BRE
	3.0 V6 TDI		01.06	03.10	PR: 1KQ				
	3.0 V6 TDI	176	10.07	03.10	PR: 1KQ				
	3.2 V6		11.02	12.05	PR: 1KQ				
	3.6 V6 FSI	206	01.06	03.10	PR: 1KQ				
	4.2 V8	228	01.06	11.06	PR: 1KQ				
	4.2 V8 FSI	257	12.06	03.10	PR: 1KQ				
	5.0 TDI R50	258	01.08	03.10	PR: 1KQ				
	5.0 V10 TDI	230	01.06	03.10	PR: 1KQ				
	6.0 W12	331	01.06	11.06	PR: 1KQ				
	2.5 R5 TDI		01.03	03.10	PR: 1KF	G1020711		23694 16,4 /WD	BRE
	3.0 V6 TDI		11.04	03.10	PR: 1KF				
	3.0 V6 TDI	176	10.07	03.10	PR: 1KF				
	3.2 V6		11.02	12.05	PR: 1KF				
	3.6 V6 FSI	206	01.06	03.10	PR: 1KF				
	4.2 V8	228	12.02	11.06	PR: 1KF				
	4.2 V8 FSI	257	12.06	03.10	PR: 1KF				
	5.0 TDI R50	258	01.08	03.10	PR: 1KF				
	5.0 V10 TDI	230	11.02	03.10	PR: 1KF				
	6.0 W12	331	08.04	11.06	PR: 1KF				
	2.5 R5 TDI		01.03	03.10	PR: 1KD,2ED	G1020999		24296 15,5 /WD	BRE
	3.0 V6 TDI		11.04	03.10	PR: 1KD,2ED				
	3.0 V6 TDI	176	10.07	03.10	PR: 1KD,2ED				
	3.6 V6 FSI	206	01.06	03.10	PR: 1KD,2ED				
	4.2 V8 FSI	257	12.06	03.10	PR: 1KD,2ED				
	5.0 TDI R50	258	01.08	03.10	PR: 1KD,2ED				
	5.0 V10 TDI	230	11.02	03.10	PR: 1KD,2ED				

### VOLKSWAGEN TOUAREG II (10-)

	3.0 V6 TDI	150	04.10	10.11	PR: 1LE	G1201010		24098 17,1 /WD	BRE					
	3.0 V6 TDI	165	06.10	10.11	PR: 1LE									
	3.0 V6 TDI	176	04.10	10.11	PR: 1LE									
	3.0 V6 TDI	180	05.11	10.11	PR: 1LE									
	3.0 V6 TSI Hybrid	245	04.10	10.11	PR: 1LE									
	3.6 V6 FSI	206	04.10	10.11	PR: 1LE									
	4.2 V8 FSI	265	01.11	10.11	PR: 1LE									
	4.2 V8 TDI	250	04.10	10.11	PR: 1LE									
		3.0 V6 TDI	150	04.10						PR: 1LC	G1201010		24098 17,1 /WD	BRE
		3.0 V6 TDI	165	06.10						PR: 1LC				
3.0 V6 TDI		176	04.10		PR: 1LC									
3.0 V6 TDI		180	05.11		PR: 1LC									
3.0 V6 TSI Hybrid		245	04.10		PR: 1LC									
3.6 V6 FSI		206	04.10		PR: 1LC									
4.2 V8 FSI		265	01.11		PR: 1LC									
4.2 V8 TDI		250	04.10		PR: 1LC									
	3.0 V6 TDI	150	04.10		PR: 1LG,1LW	G1201079		24553 15,8 /WD	BRE					
	3.0 V6 TDI	165	06.10		PR: 1LG,1LW									
	3.0 V6 TDI	176	04.10		PR: 1LG,1LW									
	3.0 V6 TDI	180	05.11		PR: 1LG,1LW									
	3.0 V6 TSI Hybrid	245	04.10		PR: 1LG,1LW									
	3.6 V6 FSI	206	04.10		PR: 1LG,1LW									
	4.2 V8 FSI	265	01.11		PR: 1LG,1LW									
	4.2 V8 TDI	250	04.10		PR: 1LG,1LW									
	3.0 V6 TDI	150	04.10		PR: 1LJ	G1201079		24553 15,8 /WD	BRE					
	3.0 V6 TDI	165	06.10		PR: 1LJ									
	3.0 V6 TDI	176	04.10		PR: 1LJ									
	3.0 V6 TDI	180	05.11		PR: 1LJ									
	3.0 V6 TSI Hybrid	245	04.10		PR: 1LJ									
	3.6 V6 FSI	206	04.10		PR: 1LJ									
	4.2 V8 FSI	265	01.11		PR: 1LJ									
	4.2 V8 TDI	250	04.10		PR: 1LJ									

### VOLKSWAGEN TOURAN (03-)

	1.2 TSI	77	05.10		PR: 1ZA,1ZD,1ZE,1ZP,1LJ	G1020680		23587 20,6 +/WI	ATE
	1.4 TSI	103	09.06		PR: 1ZA,1ZD,1ZE,1ZP,1LJ				
	1.4 TSI	125	11.06		PR: 1ZA,1ZD,1ZE,1ZP,1LJ				
	1.4 TSI EcoFuel	110	05.09		PR: 1ZA,1ZD,1ZE,1ZP,1LJ				
	1.6	75	07.03		PR: 1ZA,1ZD,1ZE,1ZP,1LJ				
	1.6 FSI	85	02.03		PR: 1ZA,1ZD,1ZE,1ZP,1LJ				
	1.6 TDI		05.10		PR: 1ZA,1ZD,1ZE,1ZP,1LJ				
	1.9 TDI	66	11.04		PR: 1ZA,1ZD,1ZE,1ZP,1LJ				
	1.9 TDI	74	02.03		PR: 1ZA,1ZD,1ZE,1ZP,1LJ				
	1.9 TDI	77	08.03		PR: 1ZA,1ZD,1ZE,1ZP,1LJ				
	2.0 Eco Fuel	80	02.06		PR: 1ZA,1ZD,1ZE,1ZP,1LJ				
	2.0 FSI	85	10.04		PR: 1ZA,1ZD,1ZE,1ZP,1LJ				
	2.0 FSI	110	10.03		PR: 1ZA,1ZD,1ZE,1ZP,1LJ				
	2.0 TDI	81	02.03		PR: 1ZA,1ZD,1ZE,1ZP,1LJ				





**VOLKSWAGEN TOURAN (03-)**

	2.0 TDI 96 2.0 TDI 103 2.0 TDI 125		01.13 08.03 02.06	PR: 1ZA,1ZD,1ZE,1ZP,1LJ PR: 1ZA,1ZD,1ZE,1ZP,1LJ PR: 1ZA,1ZD,1ZE,1ZP,1LJ	G1020680		23587 20,6 +/Wl	ATE
	1.2 TSI 77 1.4 TSI 103 1.4 TSI 125 1.4 TSI EcoFuel 110 1.6 75 1.6 FSI 85 1.6 TDI 85 1.9 TDI 66 1.9 TDI 74 1.9 TDI 77 2.0 Eco Fuel 80 2.0 FSI 85 2.0 FSI 110 2.0 TDI 81 2.0 TDI 96 2.0 TDI 103 2.0 TDI 125		05.10 09.06 11.06 05.09 07.03 02.03 05.10 11.04 02.03 08.03 02.06 10.04 10.03 02.03 01.13 08.03 02.06	PR: 1ZE,1ZP PR: 1ZE,1ZP PR: 1ZE,1ZP PR: 1ZE,1ZP PR: 1ZE,1ZP PR: 1ZE,1ZP PR: 1ZE,1ZP PR: 1ZE,1ZP PR: 1ZE,1ZP PR: 1ZE,1ZP PR: 1ZE,1ZP PR: 1ZE,1ZP PR: 1ZE,1ZP PR: 1ZE,1ZP PR: 1ZE,1ZP PR: 1ZE,1ZP	G2125145		288 25,0 22,0 V L +S +C	
	1.2 TSI 77 1.4 TSI 103 1.4 TSI 125 1.4 TSI EcoFuel 110 1.6 75 1.6 FSI 85 1.6 TDI 85 1.9 TDI 66 1.9 TDI 74 1.9 TDI 77 2.0 Eco Fuel 80 2.0 FSI 85 2.0 FSI 110 2.0 TDI 81 2.0 TDI 96 2.0 TDI 103 2.0 TDI 125		05.10 09.06 11.06 05.09 07.03 02.03 05.10 11.04 02.03 08.03 02.06 10.04 10.03 02.03 01.13 08.03 02.06	PR: 1LJ,1ZA,1ZD PR: 1LJ,1ZA,1ZD PR: 1LJ,1ZA,1ZD PR: 1LJ,1ZA,1ZD PR: 1LJ,1ZA,1ZD PR: 1LJ,1ZA,1ZD PR: 1LJ,1ZA,1ZD PR: 1LJ,1ZA,1ZD PR: 1LJ,1ZA,1ZD PR: 1LJ,1ZA,1ZD PR: 1LJ,1ZA,1ZD PR: 1LJ,1ZA,1ZD PR: 1LJ,1ZA,1ZD PR: 1LJ,1ZA,1ZD PR: 1LJ,1ZA,1ZD PR: 1LJ,1ZA,1ZD	G2125158		312 25,0 22,0 V L +S +C	
	1.2 TSI 77 1.4 TSI 103 1.4 TSI 125 1.4 TSI EcoFuel 110 1.6 75 1.6 FSI 85 1.6 TDI 85 1.9 TDI 66 1.9 TDI 74 1.9 TDI 77 2.0 Eco Fuel 80 2.0 FSI 85 2.0 FSI 110 2.0 TDI 81 2.0 TDI 96 2.0 TDI 103 2.0 TDI 125		05.10 09.06 11.06 05.09 07.03 02.03 05.10 11.04 02.03 08.03 02.06 10.04 10.03 02.03 01.13 08.03 02.06	PR: 1KE,1KF,1KJ PR: 1KE,1KF,1KJ PR: 1KE,1KF,1KJ PR: 1KE,1KF,1KJ PR: 1KE,1KF,1KJ PR: 1KE,1KF,1KJ PR: 1KE,1KF,1KJ PR: 1KE,1KF,1KJ PR: 1KE,1KF,1KJ PR: 1KE,1KF,1KJ PR: 1KE,1KF,1KJ PR: 1KE,1KF,1KJ PR: 1KE,1KF,1KJ PR: 1KE,1KF,1KJ PR: 1KE,1KF,1KJ PR: 1KE,1KF,1KJ	G1020682		23914 17,1 /WD/Acc/S	LUC
	1.2 TSI 77 1.4 TSI 103 1.4 TSI 125 1.4 TSI EcoFuel 110 1.6 75 1.6 FSI 85 1.6 TDI 85 1.9 TDI 66 1.9 TDI 74 1.9 TDI 77 2.0 Eco Fuel 80 2.0 FSI 85 2.0 FSI 110 2.0 TDI 81 2.0 TDI 96 2.0 TDI 103 2.0 TDI 125		05.10 09.06 11.06 05.09 07.03 02.03 05.10 11.04 02.03 08.03 02.06 10.04 10.03 02.03 01.13 08.03 02.06	PR: 1KE,1KF PR: 1KE,1KF PR: 1KE,1KF PR: 1KE,1KF PR: 1KE,1KF PR: 1KE,1KF PR: 1KE,1KF PR: 1KE,1KF PR: 1KE,1KF PR: 1KE,1KF PR: 1KE,1KF PR: 1KE,1KF PR: 1KE,1KF PR: 1KE,1KF PR: 1KE,1KF	G2112158		256 12,0 10,0 +C	
	1.2 TSI 77 1.4 TSI 103 1.4 TSI 125 1.4 TSI EcoFuel 110 1.6 75 1.6 FSI 85 1.6 TDI 85 1.9 TDI 66 1.9 TDI 74 1.9 TDI 77 2.0 Eco Fuel 80 2.0 FSI 85 2.0 FSI 110 2.0 TDI 81 2.0 TDI 96 2.0 TDI 103 2.0 TDI 125		05.10 09.06 11.06 05.09 07.03 02.03 05.10 11.04 02.03 08.03 02.06 10.04 10.03 02.03 01.13 08.03 02.06	PR: 1KJ PR: 1KJ PR: 1KJ PR: 1KJ PR: 1KJ PR: 1KJ PR: 1KJ PR: 1KJ PR: 1KJ PR: 1KJ PR: 1KJ PR: 1KJ PR: 1KJ PR: 1KJ PR: 1KJ PR: 1KJ	G2112169		282 12,0 10,0 +S +C	



**VOLKSWAGEN TOURAN (03-)**

	2.0 TDI	125		<b>02.06</b>	PR: 1KJ	<b>G2112169</b>		282 12,0 10,0 +S +C
	1.2 TSI	77		<b>05.10</b>	PR: 1KS	<b>G2110356</b>		272 9,7 8,0 +S +C
	1.4 TSI	103		<b>09.06</b>	PR: 1KS			
	1.4 TSI	125		<b>11.06</b>	PR: 1KS			
	1.4 TSI EcoFuel	110		<b>05.09</b>	PR: 1KS			
	1.6	75		<b>07.03</b>	PR: 1KS			
	1.6 FSI	85		<b>02.03</b>	PR: 1KS			
	1.6 TDI			<b>05.10</b>	PR: 1KS			
	1.9 TDI	66		<b>11.04</b>	PR: 1KS			
	1.9 TDI	74		<b>02.03</b>	PR: 1KS			
	1.9 TDI	77		<b>08.03</b>	PR: 1KS			
	2.0 Eco Fuel	80		<b>02.06</b>	PR: 1KS			
	2.0 FSI	85		<b>10.04</b>	PR: 1KS			
	2.0 FSI	110		<b>10.03</b>	PR: 1KS			
	2.0 TDI	81		<b>02.03</b>	PR: 1KS			
	2.0 TDI	96		<b>01.13</b>	PR: 1KS			
	2.0 TDI	103		<b>08.03</b>	PR: 1KS			
	2.0 TDI	125		<b>02.06</b>	PR: 1KS			

**VOLKSWAGEN TRANSPORTER (T4) (90-03)**

	1.8			<b>12.90</b>	<b>07.92</b>	PR: 1LA	<b>G1020304</b>		20124 18,9 /S	LUC
	1.9 D			<b>07.90</b>	<b>04.96</b>	PR: 1LA				
	1.9 TD			<b>10.92</b>	<b>04.96</b>	PR: 1LA				
	2.0			<b>07.90</b>	<b>04.96</b>	PR: 1LA				
	2.4 D			<b>07.90</b>	<b>04.96</b>	PR: 1LA				
	2.5			<b>10.90</b>	<b>04.96</b>	PR: 1LA				
	2.5 TDI			<b>09.95</b>	<b>04.96</b>	PR: 1LA				
	1.9 D	70-P-160001	70-X-250000			PR: 1LP	<b>G1020347</b>		21479 19,2 /S	LUC
	1.9 TD	70-P-160001	70-X-250000			PR: 1LP				
	2.0	70-P-160001	70-X-250000			PR: 1LP				
	2.4 D	70-P-160001	70-X-250000			PR: 1LP				
	2.4 D Syncro		70-X-250000	<b>11.92</b>		PR: 1LP				
	2.5	70-P-160001	70-X-250000			PR: 1LP				
	2.5 Syncro		70-X-250000	<b>11.92</b>		PR: 1LP				
	2.5 TDI		70-X-250000	<b>09.95</b>		PR: 1LP				
	2.5 TDI Syncro		70-X-250000	<b>09.95</b>		PR: 1LP				
	2.8		70-X-250000	<b>11.95</b>		PR: 1LP				
	1.9 D	70-Y-000001		<b>09.03</b>		PR: 1LP	<b>G1020524</b>		21479 19,2 +/M/S	LUC
	1.9 TD	70-Y-000001		<b>09.03</b>		PR: 1LP				
	2.0	70-Y-000001		<b>09.03</b>		PR: 1LP				
	2.4 D	70-Y-000001		<b>09.03</b>		PR: 1LP				
	2.4 D Syncro	70-Y-000001		<b>09.03</b>		PR: 1LP				
	2.5	70-Y-000001		<b>09.03</b>		PR: 1LP				
	2.5 Syncro	70-Y-000001		<b>09.03</b>		PR: 1LP				
	2.5 TDI	70-Y-000001		<b>09.03</b>		PR: 1LP				
	2.5 TDI Syncro	70-Y-000001		<b>09.03</b>		PR: 1LP				
	2.8	70-Y-000001		<b>09.03</b>		PR: 1LP				
	1.9 D		70-X-250000	<b>07.90</b>		PR: 1LE	<b>G1020315</b>		21635 18,0 +	LUC
	1.9 TD		70-X-250000	<b>10.92</b>		PR: 1LE				
	2.0		70-X-250000	<b>07.90</b>		PR: 1LE				
	2.4 D		70-X-250000	<b>07.90</b>		PR: 1LE				
	2.4 D Syncro		70-X-250000	<b>11.92</b>		PR: 1LE				
	2.5		70-X-250000	<b>10.90</b>		PR: 1LE				
	2.5 Syncro		70-X-250000	<b>11.92</b>		PR: 1LE				
	2.5 TDI		70-X-250000	<b>09.95</b>		PR: 1LE				
	2.5 TDI Syncro		70-X-250000	<b>09.95</b>		PR: 1LE				
	2.8		70-X-250000	<b>11.95</b>		PR: 1LE				
	1.9 D	70-Y-000001		<b>09.03</b>		PR: 1LE	<b>G1020533</b>		23176 18,7 +/M	LUC
	1.9 TD	70-Y-000001		<b>09.03</b>		PR: 1LE				
	2.0	70-Y-000001		<b>09.03</b>		PR: 1LE				
	2.4 D	70-Y-000001		<b>09.03</b>		PR: 1LE				
	2.4 D Syncro	70-Y-000001		<b>09.03</b>		PR: 1LE				
	2.5	70-Y-000001		<b>09.03</b>		PR: 1LE				
	2.5 Syncro	70-Y-000001		<b>09.03</b>		PR: 1LE				
	2.5 TDI	70-Y-000001		<b>09.03</b>		PR: 1LE				
	2.5 TDI Syncro	70-Y-000001		<b>09.03</b>		PR: 1LE				
	2.8	70-Y-000001		<b>09.03</b>		PR: 1LE				
	1.9 D		70-X-250000	<b>05.96</b>		PR: 1LU	<b>G1020419</b>		21883 19,8 +	ATE
	1.9 TD		70-X-250000	<b>05.96</b>		PR: 1LU				
	2.0		70-X-250000	<b>05.96</b>		PR: 1LU				
	2.4 D		70-X-250000	<b>05.96</b>		PR: 1LU				
	2.4 D Syncro		70-X-250000	<b>07.95</b>		PR: 1LU				
	2.5		70-X-250000	<b>05.96</b>		PR: 1LU				
	2.5 Syncro		70-X-250000	<b>07.95</b>		PR: 1LU				
	2.5 TDI		70-X-250000	<b>05.96</b>		PR: 1LU				
	2.5 TDI Syncro		70-X-250000	<b>09.95</b>		PR: 1LU				
	2.8		70-X-250000	<b>11.95</b>		PR: 1LU				
	1.9 D	70-Y-000001		<b>09.03</b>		PR: 1LU	<b>G1020534</b>		21885 20,4 +/M	ATE
	1.9 TD	70-Y-000001		<b>09.03</b>		PR: 1LU				
	2.0	70-Y-000001		<b>09.03</b>		PR: 1LU				
	2.4 D	70-Y-000001		<b>09.03</b>		PR: 1LU				
	2.4 D Syncro	70-Y-000001		<b>09.03</b>		PR: 1LU				
	2.5	70-Y-000001		<b>09.03</b>		PR: 1LU				
	2.5 Syncro	70-Y-000001		<b>09.03</b>		PR: 1LU				
	2.5 TDI	70-Y-000001		<b>09.03</b>		PR: 1LU				
	2.5 TDI Syncro	70-Y-000001		<b>09.03</b>		PR: 1LU				







**VOLKSWAGEN TRANSPORTER (T4) (90-03)**

	2.8	70-Y-000001		<b>09.03</b>	PR: 1LU	<b>G1020534</b>		21885 20,4 +/Wl	<b>ATE</b>
	1.9 D		70-1-000954	<b>05.97</b>	PR: 1LB	<b>G1020527</b>		21479 19,2 +/Wl/S	<b>ATE</b>
	1.9 TD		70-1-000954	<b>05.97</b>	PR: 1LB				
	2.0		70-1-000954	<b>05.97</b>	PR: 1LB				
	2.4 D		70-1-000954	<b>05.97</b>	PR: 1LB				
	2.5		70-1-000954	<b>05.97</b>	PR: 1LB				
	2.5 TDI		70-1-000954	<b>05.97</b>	PR: 1LB				
	2.8		70-1-000954	<b>05.97</b>	PR: 1LB				
	1.9 D	70-1-000955		<b>09.03</b>	PR: 1LB	<b>G1020580</b>		23269 19,8 +/Wl	<b>ATE</b>
	1.9 TD	70-1-000955		<b>09.03</b>	PR: 1LB				
	2.0	70-1-000955		<b>09.03</b>	PR: 1LB				
	2.4 D	70-1-000955		<b>09.03</b>	PR: 1LB				
	2.4 D Syncro			<b>07.95</b>	PR: 1LB				
	2.5	70-1-000955		<b>09.03</b>	PR: 1LB				
	2.5 Syncro			<b>07.95</b>	PR: 1LB				
	2.5 TDI	70-1-000955		<b>09.03</b>	PR: 1LB				
	2.5 TDI Syncro			<b>09.95</b>	PR: 1LB				
	2.8	70-1-000955		<b>09.03</b>	PR: 1LB				
	1.9 D	70-T-200000		<b>09.03</b>	PR: 2E2	<b>G1020658</b>		23224 16,5 +/Wl/Acc/S	<b>LUC</b>
	1.9 TD	70-T-200000		<b>09.03</b>	PR: 2E2				
	2.0	70-T-200000		<b>09.03</b>	PR: 2E2				
	2.4 D	70-T-200000		<b>09.03</b>	PR: 2E2				
	2.4 D Syncro	70-T-200000		<b>09.03</b>	PR: 2E2				
	2.5	70-T-200000		<b>09.03</b>	PR: 2E2				
	2.5 Syncro	70-T-200000		<b>09.03</b>	PR: 2E2				
	2.5 TDI	70-T-200000		<b>09.03</b>	PR: 2E2				
	2.5 TDI Syncro	70-T-200000		<b>09.03</b>	PR: 2E2				
	2.8	70-T-200000		<b>09.03</b>	PR: 2E2				
	1.9 D			<b>05.97</b>	PR: 2E3	<b>G1020654</b>		23446 16,5 +/Wl/Acc/S	<b>LUC</b>
	1.9 TD			<b>05.97</b>	PR: 2E3				
	2.0			<b>05.97</b>	PR: 2E3				
	2.4 D			<b>05.97</b>	PR: 2E3				
	2.4 D Syncro			<b>05.97</b>	PR: 2E3				
	2.5			<b>05.97</b>	PR: 2E3				
	2.5 Syncro			<b>05.97</b>	PR: 2E3				
	2.5 TDI			<b>05.97</b>	PR: 2E3				
	2.5 TDI Syncro			<b>05.97</b>	PR: 2E3				
	2.8			<b>05.97</b>	PR: 2E3				
	1.9 D	70-T-200000		<b>09.03</b>	PR: 2E2	<b>G2112138</b>		280 12,0 10,0 +S +C	
	1.9 TD	70-T-200000		<b>09.03</b>	PR: 2E2				
	2.0	70-T-200000		<b>09.03</b>	PR: 2E2				
	2.4 D	70-T-200000		<b>09.03</b>	PR: 2E2				
	2.4 D Syncro			<b>05.96</b>	PR: 2E2				
	2.5	70-T-200000		<b>09.03</b>	PR: 2E2				
	2.5 Syncro			<b>05.96</b>	PR: 2E2				
	2.5 TDI	70-T-200000		<b>09.03</b>	PR: 2E2				
	2.5 TDI Syncro			<b>05.96</b>	PR: 2E2				
	2.8	70-T-200000		<b>09.03</b>	PR: 2E2				

**VOLKSWAGEN TRANSPORTER (T5) BUS / MULTIVAN / KASTEN (03-)**

	1.9 TDI	62		<b>01.06</b>	PR: 2E3	<b>G1020707</b>		23746 19,7 +/Wl	<b>ATE</b>
	1.9 TDI	63		<b>04.03</b>	PR: 2E3				
	1.9 TDI	75		<b>06.06</b>	PR: 2E3				
	1.9 TDI	77		<b>04.03</b>	PR: 2E3				
	2.0			<b>06.03</b>	PR: 2E3				
	2.0 BiTDI	132		<b>09.09</b>	PR: 2E3				
	2.0 BiTDI 4motion	132		<b>09.09</b>	PR: 2E3				
	2.0 TDI	62		<b>09.09</b>	PR: 2E3				
	2.0 TDI	75		<b>09.09</b>	PR: 2E3				
	2.0 TDI	84		<b>05.11</b>	PR: 2E3				
	2.0 TDI	100		<b>05.10</b>	PR: 2E3				
	2.0 TDI	103		<b>09.09</b>	PR: 2E3				
	2.0 TDI 4motion	100		<b>05.10</b>	PR: 2E3				
	2.0 TDI 4motion	103		<b>09.09</b>	PR: 2E3				
	2.0 TSI			<b>05.11</b>	PR: 2E3				
	2.0 TSI 4motion	150		<b>07.11</b>	PR: 2E3				
	2.5 TDI			<b>02.03</b>	PR: 2E3				
	2.5 TDI	96		<b>02.03</b>	PR: 2E3				
	2.5 TDI 4motion	96		<b>07.04</b>	PR: 2E3				
	2.5 TDI 4motion	128		<b>07.04</b>	PR: 2E3				
	3.2 V6			<b>02.03</b>	PR: 2E3				
	3.2 V6 4motion			<b>07.04</b>	PR: 2E3				
	1.9 TDI	62	7H-A-050000	<b>01.06</b>	PR: 2E4	<b>G1020706</b>		23746 18,1 +/Wl	<b>ATE</b>
	1.9 TDI	63	7H-A-050000	<b>04.03</b>	PR: 2E4				
	1.9 TDI	75	7H-A-050000	<b>06.06</b>	PR: 2E4				
	1.9 TDI	77	7H-A-050000	<b>04.03</b>	PR: 2E4				
	2.0		7H-A-050000	<b>06.03</b>	PR: 2E4				
	2.0 BiTDI	132	7H-A-050000	<b>09.09</b>	PR: 2E4				
	2.0 BiTDI 4motion	132	7H-A-050000	<b>09.09</b>	PR: 2E4				
	2.0 TDI	62	7H-A-050000	<b>09.09</b>	PR: 2E4				
	2.0 TDI	75	7H-A-050000	<b>09.09</b>	PR: 2E4				
	2.0 TDI	103	7H-A-050000	<b>09.09</b>	PR: 2E4				
	2.0 TDI 4motion	103	7H-A-050000	<b>09.09</b>	PR: 2E4				
	2.5 TDI		7H-A-050000	<b>02.03</b>	PR: 2E4				
	2.5 TDI	96	7H-A-050000	<b>02.03</b>	PR: 2E4				
	2.5 TDI 4motion	96	7H-A-050000	<b>07.04</b>	PR: 2E4				



**VOLKSWAGEN TRANSPORTER (T5) BUS / MULTIVAN / KASTEN (03-)**

	2.5 TDI 4motion 3.2 V6 3.2 V6 4motion	128	7H-A-050000 7H-A-050000 7H-A-050000	07.04 02.03 07.04	PR: 2E4 PR: 2E4 PR: 2E4	G1020706		23746 18,1 +/Wl	ATE
	1.9 TDI 1.9 TDI 1.9 TDI 1.9 TDI 2.0 2.0 BiTDI 2.0 BiTDI 4motion 2.0 TDI 2.0 TDI 2.0 TDI 2.0 TDI 2.0 TDI 2.0 TDI 2.0 TDI 2.0 TDI 2.0 TDI 2.0 TDI 2.0 TDI 2.0 TDI 2.0 TDI 2.0 TDI 2.0 TDI 2.5 TDI 2.5 TDI 2.5 TDI 2.5 TDI 4motion 2.5 TDI 4motion 3.2 V6 3.2 V6 4motion	62 63 75 77  132 132 62 75 84 100 103 100 103 150 96 96 128		01.06 04.03 06.06 04.03 06.03 09.09 09.09 09.09 05.11 05.10 09.09 05.10 09.09 05.11 07.11 02.03 02.03 07.04 07.04 02.03 07.04	PR: 2E3 PR: 2E3	G2130114		308 29,5 25,5 V L +C	
	1.9 TDI 1.9 TDI 2.0 2.5 TDI 2.5 TDI 2.5 TDI 4motion 2.5 TDI 4motion 3.2 V6 3.2 V6 4motion	63 77  96 96 128	7H-5-120000 7H-5-120000 7H-5-120000 7H-5-120000 7H-5-120000 7H-5-120000 7H-5-120000 7H-5-120000	04.03 04.03 06.03 02.03 02.03 07.04 07.04 02.03 07.04	PR: OWL,OWN,OWM,OWP,OWQ PR: OWL,OWN,OWM,OWP,OWQ PR: OWL,OWN,OWM,OWP,OWQ PR: OWL,OWN,OWM,OWP,OWQ PR: OWL,OWN,OWM,OWP,OWQ PR: OWL,OWN,OWM,OWP,OWQ PR: OWL,OWN,OWM,OWP,OWQ PR: OWL,OWN,OWM,OWP,OWQ	G1020691		23326 17,4 /Wl/Acc/S	LUC
	1.9 TDI 1.9 TDI 1.9 TDI 1.9 TDI 2.0 2.0 BiTDI 2.0 BiTDI 4motion 2.0 TDI 2.0 TDI 2.0 TDI 2.0 TDI 4motion 2.5 TDI 2.5 TDI 2.5 TDI 4motion 2.5 TDI 4motion 3.2 V6 3.2 V6 4motion	62 63 75 77  132 132 62 75 103 103 96 96 128	7H-6-000001 7H-A-050000 7H-A-050000 7H-A-050000 7H-A-050000 7H-A-050000 7H-A-050000 7H-A-050000 7H-A-050000 7H-A-050000 7H-A-050000 7H-A-050000 7H-A-050000 7H-A-050000 7H-A-050000 7H-A-050000 7H-A-050000		PR: 2E3,2E4 PR: 2E3,2E4 PR: 2E3,2E4 PR: 2E3,2E4 PR: 2E3,2E4 PR: 2E3,2E4 PR: 2E3,2E4 PR: 2E3,2E4 PR: 2E3,2E4 PR: 2E3,2E4 PR: 2E3,2E4 PR: 2E3,2E4 PR: 2E3,2E4 PR: 2E3,2E4 PR: 2E3,2E4 PR: 2E3,2E4 PR: 2E3,2E4	G1020691		23326 17,4 /Wl/Acc/S	LUC
	1.9 TDI 1.9 TDI 1.9 TDI 1.9 TDI 2.0 2.5 TDI 2.5 TDI 2.5 TDI 4motion 2.5 TDI 4motion 3.2 V6 3.2 V6 4motion	62 63 75 77  96 96 128	7H-8-027999 7H-8-027999 7H-8-027999 7H-8-027999 7H-8-027999 7H-8-027999 7H-8-027999 7H-8-027999 7H-8-027999 7H-8-027999 7H-8-027999	01.06 04.03 06.06 04.03 06.03 02.03 02.03 07.04 07.04 02.03 07.04	PR: OWR PR: OWR PR: OWR PR: OWR PR: OWR PR: OWR PR: OWR PR: OWR PR: OWR PR: OWR PR: OWR	G1020699		24367 19,1 +/Wl	ATE
	1.9 TDI 1.9 TDI 1.9 TDI 1.9 TDI 2.0 2.5 TDI 2.5 TDI 2.5 TDI 4motion 2.5 TDI 4motion 3.2 V6 3.2 V6 4motion	62 63 75 77  96 96 128	7H-8-028000 7H-8-028000 7H-8-028000 7H-8-028000 7H-8-028000 7H-8-028000 7H-8-028000 7H-8-028000 7H-8-028000 7H-8-028000 7H-8-028000		PR: OWR PR: OWR PR: OWR PR: OWR PR: OWR PR: OWR PR: OWR PR: OWR PR: OWR PR: OWR PR: OWR	G1020691		23326 17,4 /Wl/Acc/S	LUC
	1.9 TDI 1.9 TDI 1.9 TDI 1.9 TDI 2.0 2.0 BiTDI 2.0 BiTDI 4motion 2.0 TDI 2.0 TDI 2.0 TDI 2.0 TDI 2.0 TDI 2.0 TDI 2.0 TDI 2.0 TDI 4motion	62 63 75 77  132 132 62 75 84 100 103 100	7H-A-200001 7H-A-200001 7H-A-200001 7H-A-200001 7H-A-200001 7H-A-200001 7H-A-200001 7H-A-200001 7H-A-200001 7H-A-200001 7H-A-200001 7H-A-200001 7H-A-200001 7H-A-200001 7H-A-200001		05.11	G1020691		23326 17,4 /Wl/Acc/S	LUC





**VOLKSWAGEN TRANSPORTER (T5) BUS / MULTIVAN / KASTEN (03-)**

	2.0 TDI 4motion 2.0 TSI 2.0 TSI 4motion 2.5 TDI 2.5 TDI 2.5 TDI 4motion 2.5 TDI 4motion 3.2 V6 3.2 V6 4motion	103 7H-A-200001 150 7H-A-200001 96 7H-A-200001 96 7H-A-200001 128 7H-A-200001 7H-A-200001 7H-A-200001	05.11 07.11		G1020691		23326 17,4 /W/Acc/S	LUC
	1.9 TDI 1.9 TDI 2.0 2.5 TDI 2.5 TDI 2.5 TDI 4motion 2.5 TDI 4motion 3.2 V6 3.2 V6 4motion	63 77 96 96 128	7H-5-120000 7H-5-120000 7H-5-120000 7H-5-120000 7H-5-120000 7H-5-120000 7H-5-120000 7H-5-120000 7H-5-120000	04.03 04.03 06.03 02.03 02.03 07.04 07.04 02.03 07.04	PR: OWL,OWN,OWM,OWP,OWQ PR: OWL,OWN,OWM,OWP,OWQ PR: OWL,OWN,OWM,OWP,OWQ PR: OWL,OWN,OWM,OWP,OWQ PR: OWL,OWN,OWM,OWP,OWQ PR: OWL,OWN,OWM,OWP,OWQ PR: OWL,OWN,OWM,OWP,OWQ PR: OWL,OWN,OWM,OWP,OWQ PR: OWL,OWN,OWM,OWP,OWQ	G2122211		294 21,9 19,5 V L +C
	1.9 TDI 1.9 TDI 1.9 TDI 1.9 TDI 2.0 2.0 BiTDI 2.0 BiTDI 4motion 2.0 TDI 2.0 TDI 2.0 TDI 2.0 TDI 4motion 2.5 TDI 2.5 TDI 2.5 TDI 4motion 2.5 TDI 4motion 3.2 V6 3.2 V6 4motion	62 63 75 77 132 132 62 75 103 103 7H-6-000001 96 96 128 7H-6-000001 7H-6-000001	7H-6-000001 7H-6-000001 7H-6-000001 7H-6-000001 7H-6-000001 7H-6-000001 7H-6-000001 7H-6-000001 7H-6-000001 7H-6-000001 7H-6-000001 7H-6-000001 7H-6-000001 7H-6-000001 7H-6-000001 7H-6-000001 7H-6-000001		PR: 2E3,2E4 PR: 2E3,2E4 PR: 2E3,2E4 PR: 2E3,2E4 PR: 2E3,2E4 PR: 2E3,2E4 PR: 2E3,2E4 PR: 2E3,2E4 PR: 2E3,2E4 PR: 2E3,2E4 PR: 2E3,2E4 PR: 2E3,2E4 PR: 2E3,2E4 PR: 2E3,2E4 PR: 2E3,2E4 PR: 2E3,2E4	G2122211		294 21,9 19,5 V L +C
	1.9 TDI 1.9 TDI 1.9 TDI 1.9 TDI 2.0 2.5 TDI 2.5 TDI 2.5 TDI 4motion 2.5 TDI 4motion 3.2 V6 3.2 V6 4motion	62 63 75 77 96 96 128	7H-8-028000 7H-8-028000 7H-8-028000 7H-8-028000 7H-8-028000 7H-8-028000 7H-8-028000 7H-8-028000 7H-8-028000 7H-8-028000 7H-8-028000		PR: OWR PR: OWR PR: OWR PR: OWR PR: OWR PR: OWR PR: OWR PR: OWR PR: OWR PR: OWR	G2122211		294 21,9 19,5 V L +C
	1.9 TDI 1.9 TDI 1.9 TDI 1.9 TDI 2.0 2.0 BiTDI 2.0 BiTDI 4motion 2.0 TDI 2.0 TDI 2.0 TDI 2.0 TDI 4motion 2.0 TDI 4motion 2.0 TSI 2.0 TSI 4motion 2.5 TDI 2.5 TDI 2.5 TDI 4motion 2.5 TDI 4motion 3.2 V6 3.2 V6 4motion	62 63 75 77 132 132 62 75 84 100 103 100 103 150 7H-A-200001 96 96 128 7H-A-200001 7H-A-200001	7H-A-200001 7H-A-200001 7H-A-200001 7H-A-200001 7H-A-200001 7H-A-200001 7H-A-200001 7H-A-200001 7H-A-200001 7H-A-200001 7H-A-200001 7H-A-200001 7H-A-200001 7H-A-200001 7H-A-200001 7H-A-200001 7H-A-200001 7H-A-200001 7H-A-200001 7H-A-200001	05.11 05.11 07.11		G2122211		294 21,9 19,5 V L +C

**VOLKSWAGEN TRANSPORTER (T5) PRITSCH / FAHRGESTELL (03-)**

	1.9 TDI 1.9 TDI 1.9 TDI 1.9 TDI 2.0 2.0 BiTDI 2.0 BiTDI 4motion 2.0 TDI 2.0 TDI 2.0 TDI 2.0 TDI 2.0 TDI 2.0 TDI 4motion 2.0 TDI 4motion 2.0 TSI 2.5 TDI 2.5 TDI	62 63 75 77 85 132 132 62 75 84 100 103 100 103 110 96 128	01.06 04.03 06.06 04.03 06.03 09.09 09.09 09.09 09.09 05.11 05.10 09.09 05.10 09.09 07.12 02.03 02.03	PR: 2E3 PR: 2E3 PR: 2E3 PR: 2E3 PR: 2E3 PR: 2E3 PR: 2E3 PR: 2E3 PR: 2E3 PR: 2E3 PR: 2E3 PR: 2E3 PR: 2E3 PR: 2E3 PR: 2E3 PR: 2E3	G1020707		23746 19,7 +/W/	ATE
--	---	--	---	--	----------	--	-----------------	-----



**VOLKSWAGEN TRANSPORTER (T5) PRITSCH / FAHRGESTELL (03-)**

	2.5 TDI 4motion	96		<b>07.04</b>	PR: 2E3	<b>G1020707</b>		23746 19,7 +/Wl	<b>ATE</b>
	2.5 TDI 4motion	128		<b>07.04</b>	PR: 2E3				
	3.2 V6	170		<b>02.04</b>	PR: 2E3				
	3.2 V6	173		<b>08.03</b>	PR: 2E3				
	1.9 TDI	62	7J-A-010000	<b>01.06</b>	PR: 2E4	<b>G1020706</b>		23746 18,1 +/Wl	<b>ATE</b>
	1.9 TDI	63	7J-A-010000	<b>04.03</b>	PR: 2E4				
	1.9 TDI	75	7J-A-010000	<b>06.06</b>	PR: 2E4				
	1.9 TDI	77	7J-A-010000	<b>04.03</b>	PR: 2E4				
	2.0	85	7J-A-010000	<b>06.03</b>	PR: 2E4				
	2.0 BiTDI	132	7J-A-010000	<b>09.09</b>	PR: 2E4				
2.0 BiTDI 4motion	132	7J-A-010000	<b>09.09</b>	PR: 2E4					
2.0 TDI	62	7J-A-010000	<b>09.09</b>	PR: 2E4					
2.0 TDI	75	7J-A-010000	<b>09.09</b>	PR: 2E4					
2.0 TDI	103	7J-A-010000	<b>09.09</b>	PR: 2E4					
2.0 TDI 4motion	103	7J-A-010000	<b>09.09</b>	PR: 2E4					
2.5 TDI	96	7J-A-010000	<b>02.03</b>	PR: 2E4					
2.5 TDI	128	7J-A-010000	<b>02.03</b>	PR: 2E4					
2.5 TDI 4motion	96	7J-A-010000	<b>07.04</b>	PR: 2E4					
2.5 TDI 4motion	128	7J-A-010000	<b>07.04</b>	PR: 2E4					
3.2 V6	170	7J-A-010000	<b>02.04</b>	PR: 2E4					
3.2 V6	173	7J-A-010000	<b>08.03</b>	PR: 2E4					
	1.9 TDI	62		<b>01.06</b>	PR: 2E3	<b>G2130114</b>		308 29,5 25,5 V L +C	
	1.9 TDI	63		<b>04.03</b>	PR: 2E3				
	1.9 TDI	75		<b>06.06</b>	PR: 2E3				
	1.9 TDI	77		<b>04.03</b>	PR: 2E3				
	2.0	85		<b>06.03</b>	PR: 2E3				
	2.0 BiTDI	132		<b>09.09</b>	PR: 2E3				
	2.0 BiTDI 4motion	132		<b>09.09</b>	PR: 2E3				
	2.0 TDI	62		<b>09.09</b>	PR: 2E3				
	2.0 TDI	75		<b>09.09</b>	PR: 2E3				
	2.0 TDI	84		<b>05.11</b>	PR: 2E3				
	2.0 TDI	100		<b>05.10</b>	PR: 2E3				
	2.0 TDI	103		<b>09.09</b>	PR: 2E3				
	2.0 TDI 4motion	100		<b>05.10</b>	PR: 2E3				
	2.0 TDI 4motion	103		<b>09.09</b>	PR: 2E3				
	2.0 TSI	110		<b>07.12</b>	PR: 2E3				
	2.5 TDI	96		<b>02.03</b>	PR: 2E3				
2.5 TDI	128		<b>02.03</b>	PR: 2E3					
2.5 TDI 4motion	96		<b>07.04</b>	PR: 2E3					
2.5 TDI 4motion	128		<b>07.04</b>	PR: 2E3					
3.2 V6	170		<b>02.04</b>	PR: 2E3					
3.2 V6	173		<b>08.03</b>	PR: 2E3					
	1.9 TDI	62	7J-A-010000	<b>01.06</b>	PR: 2E3,2E4	<b>G1020691</b>		23326 17,4 /Wl/Acc/S	<b>LUC</b>
	1.9 TDI	63	7J-A-010000	<b>04.03</b>	PR: 2E3,2E4				
	1.9 TDI	75	7J-A-010000	<b>06.06</b>	PR: 2E3,2E4				
	1.9 TDI	77	7J-A-010000	<b>04.03</b>	PR: 2E3,2E4				
	2.0	85	7J-A-010000	<b>06.03</b>	PR: 2E3,2E4				
	2.0 BiTDI	132	7J-A-010000	<b>09.09</b>	PR: 2E3,2E4				
	2.0 BiTDI 4motion	132	7J-A-010000	<b>09.09</b>	PR: 2E3,2E4				
	2.0 TDI	62	7J-A-010000	<b>09.09</b>	PR: 2E3,2E4				
	2.0 TDI	75	7J-A-010000	<b>09.09</b>	PR: 2E3,2E4				
	2.0 TDI	103	7J-A-010000	<b>09.09</b>	PR: 2E3,2E4				
	2.0 TDI 4motion	103	7J-A-010000	<b>09.09</b>	PR: 2E3,2E4				
	2.5 TDI	96	7J-A-010000	<b>02.03</b>	PR: 2E3,2E4				
	2.5 TDI	128	7J-A-010000	<b>02.03</b>	PR: 2E3,2E4				
	2.5 TDI 4motion	96	7J-A-010000	<b>07.04</b>	PR: 2E3,2E4				
	2.5 TDI 4motion	128	7J-A-010000	<b>07.04</b>	PR: 2E3,2E4				
	3.2 V6	170	7J-A-010000	<b>02.04</b>	PR: 2E3,2E4				
3.2 V6	173	7J-A-010000	<b>08.03</b>	PR: 2E3,2E4					
	1.9 TDI	62	7J-8-000789	<b>01.06</b>	PR: OWR,0E0,0E9	<b>G1020699</b>		24367 19,1 +/Wl	<b>ATE</b>
	1.9 TDI	63	7J-8-000788	<b>04.03</b>	PR: OWR,0E0,0E9				
	1.9 TDI	75	7J-8-000788	<b>06.06</b>	PR: OWR,0E0,0E9				
	1.9 TDI	77	7J-8-000788	<b>04.03</b>	PR: OWR,0E0,0E9				
	2.0	85	7J-8-000788	<b>06.03</b>	PR: OWR,0E0,0E9				
	2.5 TDI	96	7J-8-000788	<b>02.03</b>	PR: OWR,0E0,0E9				
	2.5 TDI	128	7J-8-000788	<b>02.03</b>	PR: OWR,0E0,0E9				
	2.5 TDI 4motion	96	7J-8-000788	<b>07.04</b>	PR: OWR,0E0,0E9				
	2.5 TDI 4motion	128	7J-8-000788	<b>07.04</b>	PR: OWR,0E0,0E9				
	3.2 V6	170	7J-8-000788	<b>02.04</b>	PR: OWR,0E0,0E9				
3.2 V6	173	7J-8-000788	<b>08.03</b>	PR: OWR,0E0,0E9					
	1.9 TDI	62	7J-8-000789	7J-8-030000	PR: OWR,0E0,0E9	<b>G1020691</b>		23326 17,4 /Wl/Acc/S	<b>LUC</b>
	1.9 TDI	63	7J-8-000789	7J-8-030000	PR: OWR,0E0,0E9				
	1.9 TDI	75	7J-8-000789	7J-8-030000	PR: OWR,0E0,0E9				
	1.9 TDI	77	7J-8-000789	7J-8-030000	PR: OWR,0E0,0E9				
	2.0	85	7J-8-000789	7J-8-030000	PR: OWR,0E0,0E9				
	2.5 TDI	96	7J-8-000789	7J-8-030000	PR: OWR,0E0,0E9				
	2.5 TDI	128	7J-8-000789	7J-8-030000	PR: OWR,0E0,0E9				
	2.5 TDI 4motion	96	7J-8-000789	7J-8-030000	PR: OWR,0E0,0E9				
	2.5 TDI 4motion	128	7J-8-000789	7J-8-030000	PR: OWR,0E0,0E9				
	3.2 V6	170	7J-8-000789	7J-8-030000	PR: OWR,0E0,0E9				
3.2 V6	173	7J-8-000789	7J-8-030000	PR: OWR,0E0,0E9					
	1.9 TDI	62	7J-A-200001			<b>G1020691</b>		23326 17,4 /Wl/Acc/S	<b>LUC</b>
	1.9 TDI	63	7J-A-200001						
	1.9 TDI	75	7J-A-200001						
	1.9 TDI	77	7J-A-200001						
	2.0	85	7J-A-200001						
	2.0 BiTDI	132	7J-A-200001						





**VOLKSWAGEN TRANSPORTER (T5) PRITSCH / FAHRGESTELL (03-)**

	2.0 BiTDI 4motion	132	7J-A-200001				G1020691		23326 17,4 /W/Acc/S	LUC
	2.0 TDI	62	7J-A-200001							
	2.0 TDI	75	7J-A-200001							
	2.0 TDI	84			05.11					
	2.0 TDI	100			05.10					
	2.0 TDI	103	7J-A-200001							
	2.0 TDI 4motion	100			05.10					
	2.0 TDI 4motion	103	7J-A-200001							
	2.0 TSI	110			07.12					
	2.5 TDI	96	7J-A-200001							
	2.5 TDI	128	7J-A-200001							
	2.5 TDI 4motion	96	7J-A-200001							
	2.5 TDI 4motion	128	7J-A-200001							
3.2 V6	170	7J-A-200001								
3.2 V6	173	7J-A-200001								
	1.9 TDI	62	7J-A-010000	01.06		PR: 2E3,2E4	G2122211		294 21,9 19,5 V L +C	
	1.9 TDI	63	7J-A-010000	04.03		PR: 2E3,2E4				
	1.9 TDI	75	7J-A-010000	06.06		PR: 2E3,2E4				
	1.9 TDI	77	7J-A-010000	04.03		PR: 2E3,2E4				
	2.0	85	7J-A-010000	06.03		PR: 2E3,2E4				
	2.0 BiTDI	132	7J-A-010000	09.09		PR: 2E3,2E4				
	2.0 BiTDI 4motion	132	7J-A-010000	09.09		PR: 2E3,2E4				
	2.0 TDI	62	7J-A-010000	09.09		PR: 2E3,2E4				
	2.0 TDI	75	7J-A-010000	09.09		PR: 2E3,2E4				
	2.0 TDI	103	7J-A-010000	09.09		PR: 2E3,2E4				
	2.0 TDI 4motion	103	7J-A-010000	09.09		PR: 2E3,2E4				
	2.5 TDI	96	7J-A-010000	02.03		PR: 2E3,2E4				
	2.5 TDI	128	7J-A-010000	02.03		PR: 2E3,2E4				
	2.5 TDI 4motion	96	7J-A-010000	07.04		PR: 2E3,2E4				
	2.5 TDI 4motion	128	7J-A-010000	07.04		PR: 2E3,2E4				
	3.2 V6	170	7J-A-010000	02.04		PR: 2E3,2E4				
	3.2 V6	173	7J-A-010000	08.03		PR: 2E3,2E4				
	1.9 TDI	62	7J-8-000789	7J-8-030000		PR: 0WR,0E0,0E9	G2122211		294 21,9 19,5 V L +C	
	1.9 TDI	63	7J-8-000789	7J-8-030000		PR: 0WR,0E0,0E9				
	1.9 TDI	75	7J-8-000789	7J-8-030000		PR: 0WR,0E0,0E9				
	1.9 TDI	77	7J-8-000789	7J-8-030000		PR: 0WR,0E0,0E9				
	2.0	85	7J-8-000789	7J-8-030000		PR: 0WR,0E0,0E9				
	2.5 TDI	96	7J-8-000789	7J-8-030000		PR: 0WR,0E0,0E9				
	2.5 TDI	128	7J-8-000789	7J-8-030000		PR: 0WR,0E0,0E9				
	2.5 TDI 4motion	96	7J-8-000789	7J-8-030000		PR: 0WR,0E0,0E9				
	2.5 TDI 4motion	128	7J-8-000789	7J-8-030000		PR: 0WR,0E0,0E9				
	3.2 V6	170	7J-8-000789	7J-8-030000		PR: 0WR,0E0,0E9				
	3.2 V6	173	7J-8-000789	7J-8-030000		PR: 0WR,0E0,0E9				
	1.9 TDI	62	7J-A-200001				G2122211		294 21,9 19,5 V L +C	
	1.9 TDI	63	7J-A-200001							
	1.9 TDI	75	7J-A-200001							
	1.9 TDI	77	7J-A-200001							
	2.0	85	7J-A-200001							
	2.0 BiTDI	132	7J-A-200001							
	2.0 BiTDI 4motion	132	7J-A-200001							
	2.0 TDI	62	7J-A-200001							
	2.0 TDI	75	7J-A-200001							
	2.0 TDI	84			05.11					
	2.0 TDI	100			05.10					
	2.0 TDI	103	7J-A-200001							
	2.0 TDI 4motion	100			05.10					
	2.0 TDI 4motion	103	7J-A-200001							
	2.0 TSI	110			07.12					
	2.5 TDI	96	7J-A-200001							
	2.5 TDI	128	7J-A-200001							
2.5 TDI 4motion	96	7J-A-200001								
2.5 TDI 4motion	128	7J-A-200001								
3.2 V6	170	7J-A-200001								
3.2 V6	173	7J-A-200001								

**VOLKSWAGEN VENTO (92-98)**

	1.4		1H-T-015953	11.91			G1020009		20887 19,7 +/Acc	VW
	1.6	55	1H-T-015953	09.92		+ manual transmission <sup>1)</sup>				
	1.6	55	1H-S-430000	09.92		+ autom.transmission <sup>2)</sup>				
	1.8	55	1H-T-015953	01.92		+ manual transmission <sup>1)</sup>				
	1.8 CL/GL	66	1H-S-430000	01.92						
	1.9 D		1H-T-015953	11.91						
	1.9 TD	55	1H-S-430000	01.92						
	1.4		1H-T-015954			09.98 - ABS	G1020355		21866 19,7 +	VW
	1.6	55	1H-T-015954			09.98 + manual transmission <sup>1)</sup>				
	1.8	55	1H-T-015954			09.98 + manual transmission <sup>1)</sup>				
	1.9 D		1H-T-015954			09.98 - ABS				
	1.9 SDI			04.97		09.98 - ABS				
	1.6	55	1H-S-430001			09.98 + autom.transmission <sup>2)</sup>	G1020274		20168 19,3 /S	LUC
	1.6 CL/GL	74		07.94		09.98				
	1.8	55		01.92		09.98 + autom.transmission <sup>2)</sup>				
	1.8 CL/GL	66	1H-S-430001			09.98				
	1.9 TD	55	1H-S-430001			09.98				
	1.9 TDI	66		07.93		09.98 - ABS				
	1.4			05.96		09.96 + ABS	G1020444		21945 16,0 /S	LUC
	1.6 GT	74		07.94		09.98				
1.8 GT	66		01.92		09.98					

<sup>1)</sup> + scatola cambio velocità / + transmission mécanique / + cambio de velocidad / + Schaltgetriebe

<sup>2)</sup> + scatola cambio automatico / + transmission automatique / + cambio automático / + Automatikgetriebe



**VOLKSWAGEN VENTO (92-98)**

	1.9 D	66		05.96	09.96	+ ABS	G1020444		21945	16,0 /S	LUC					
	1.9 TDI	81		07.93	09.98											
	1.9 TDI			02.96	09.98	+ ABS										
	2.0 CL/GL			11.91	09.98											
	1.4			10.96	09.98	+ ABS										
	1.9 D			10.96	09.98	+ ABS	G1020390		21866	15,3 +	VW					
	1.9 SDI			04.97	09.98	+ ABS										
	2.0 GT	1H-S-560001			04.96											
	2.0 GT			05.96	09.98											
	2.8 VR6	1H-S-560001			09.98											
	1.4			11.91	09.98	- ABS						G2112106		239	12,0 10,0 +S +C	
	1.6	55	1H-S-430000	09.92		+ autom.transmission 1)										
	1.6	55		09.92	09.98	+ manual transmission 2)										
	1.8	55		01.92	09.98	+ manual transmission 2)										
	1.8 CL/GL	66	1H-S-430000	01.92												
1.9 D			11.91	09.98	- ABS											
1.9 SDI			04.97	09.98	- ABS											
1.9 TD	55	1H-S-430000	11.91													
1.6	55	1H-S-430001		09.98	+ autom.transmission 1)	G2113178		256	12,9 11,0 +S +C							
1.6 CL/GL	74		07.94	09.98												
1.8	55		01.92	09.98	+ autom.transmission 1)											
1.8 CL/GL	66	1H-S-430001		09.98												
1.9 TD	55	1H-S-430001		09.98												
1.9 TDI	66		07.93	09.98	- ABS											
1.4			05.96	09.96	+ ABS						G2120128		256	20,0 18,0 V L +S +C		
1.6 GT	74		07.94	09.98												
1.8 GT	66		01.92	09.98												
1.9 D			05.96	09.96	+ ABS											
1.9 TDI	66		07.93	09.98	+ ABS											
1.9 TDI	81		02.96	09.98												
2.0 CL/GL			11.91	09.98												
1.4			10.96	09.98	+ ABS	G2120123		239	20,0 18,0 V L +S +C							
1.9 D			10.96	09.98	+ ABS											
1.9 SDI			04.97	09.98	+ ABS											
	1.6 GT	74		07.94	09.98		G1020201		20961	15,2 /WD/Acc/S	LUC					
	1.8 GT			01.92	09.98											
	1.9 GT TDI	66		07.93	09.98											
	2.0			11.91	09.98											
	2.0 GT		1H-P-240000	11.91												
	2.8 VR6		1H-P-240000	01.92												
	1.9 TDI	81		02.96	09.98							G1020345		20961	17,0 /WD/Acc/S	LUC
2.0 GT		1H-P-240001		09.98												
2.8 VR6		1H-P-240001		09.98												
	1.6 GT	74		07.94	09.98		G2110111		226	10,0 8,0 +C						
	1.8 GT			01.92	09.98											
	1.9 GT TDI	66		07.93	09.98											
	1.9 TDI	81		02.96	09.98											
	2.0 CL/GL			11.91	09.98											

**VOLKSWAGEN up (11-)**

	1.0	44		12.11		PR: 1LA,1ZQ	G1020331		23130	19,7 +	VW
	1.0	55		12.11		PR: 1LA,1ZQ					
	1.0 EcoFuel	50		11.12		PR: 1LA,1ZQ					
	e-up	60		09.13		PR: 1ZQ					

**VOLVO 850 Saloon (91-96)**

	2.0	93		08.94	12.96		G1020956		21273	19,5 +/WD	ATE
	2.0	105		06.91	12.96						
	2.0 T	155		08.93	12.96						
	2.5	103		06.91	07.94						
	2.5	106		08.94	12.96						
	2.5	125		08.91	12.96						
	2.5 TDI	103		08.95	12.96						
	2.3 T5	166		08.93	07.96						
2.3 T5 R	184		08.95	12.96							

**VOLVO 850 Estate (92-96)**

















	2.0	93		08.94	12.96		G1020956		21273	19,5 +/WD	ATE					
	2.0	105		02.93	12.96											
	2.0 T	155		02.93	12.96											
	2.5	103		08.92	07.94											
	2.5	106		08.94	12.96											
	2.5	125		09.92	12.96											
	2.5 AWD	142		04.96	12.96											
	2.5 TDI	103		08.95	12.96											
	2.3 T5	166		02.93	12.96							G1020956		21273	19,5 +/WD	ATE
	2.3 T5 R	184		08.95	12.96											
	2.5 AWD	142		04.96	12.96		G1020955		21385	13,0 /S	LUC					

1) + scatola cambio automatico / + transmission automatique / + cambio automático / + Automatikgetriebe  
 2) + scatola cambio velocità / + transmission mécanique / + cambio de velocidad / + Schaltgetriebe  
 3) per cerch.4 fori/-sensore ruota / pour jante 4 trous/-roue codeuse / para llanta cuatro agujeros/-anillo sensor / für 4-Loch-Felge/- Sensorring



Wrench & Car		Truck & Car		Car		Car		Car		Car		Car		Car	
<b>VOLVO 940 I Saloon (90-95)</b>															
	2.0	82		01.92	07.94	+ multi link axle <sup>1)</sup>	G1020955			21385 13,0 /S	LUC				
	2.0 T	114		01.91	07.95	+ multi link axle <sup>1)</sup>									
	2.3			08.90	12.94	+ multi link axle <sup>1)</sup>									
	2.3	85		08.92	07.94	+ multi link axle <sup>1)</sup>									
	2.3	114		08.90	07.91	+ multi link axle <sup>1)</sup>									
	2.3 T	121		08.90	07.94	+ multi link axle <sup>1)</sup>									
	2.3 T	140		08.91	07.93	+ multi link axle <sup>1)</sup>									
	2.4 D	60		08.90	12.94	+ multi link axle <sup>1)</sup>									
	2.4 TD	80		08.90	12.94	+ multi link axle <sup>1)</sup>									
2.4 TD Intercooler	90		08.90	12.94	+ multi link axle <sup>1)</sup>										
<b>VOLVO 940 I Estate (90-95)</b>															
	2.0	82		01.92	07.94	+ multi link axle <sup>1)</sup>	G1020955			21385 13,0 /S	LUC				
	2.0 T	114		01.91	07.95	+ multi link axle <sup>1)</sup>									
	2.3	85		08.92	07.94	+ multi link axle <sup>1)</sup>									
	2.3	96		08.90	07.94	+ multi link axle <sup>1)</sup>									
	2.3	114		08.90	07.91	+ multi link axle <sup>1)</sup>									
	2.3 T	121		08.90	07.94	+ multi link axle <sup>1)</sup>									
	2.3 T	140		08.91	07.93	+ multi link axle <sup>1)</sup>									
	2.4 D	60		08.90	07.95	+ multi link axle <sup>1)</sup>									
	2.4 TD	80		08.90	07.94	+ multi link axle <sup>1)</sup>									
2.4 TD Intercooler	90		08.90	07.94	+ multi link axle <sup>1)</sup>										
<b>VOLVO 940 II Saloon (95-98)</b>															
	2.0 T	114		04.96	10.98	+ multi link axle <sup>1)</sup>	G1020955			21385 13,0 /S	LUC				
	2.3	85		08.94	07.95	+ multi link axle <sup>1)</sup>									
	2.3	96		08.94	10.98	+ multi link axle <sup>1)</sup>									
	2.3 T	121		08.94	10.98	+ multi link axle <sup>1)</sup>									
	2.3 ti	99		01.95	10.98	+ multi link axle <sup>1)</sup>									
	2.4 TD Intercooler	90		08.94	10.98	+ multi link axle <sup>1)</sup>									
<b>VOLVO 940 II Estate (95-98)</b>															
	2.0 T	114		04.96	10.98	+ multi link axle <sup>1)</sup>	G1020955			21385 13,0 /S	LUC				
	2.3	85		08.94	07.95	+ multi link axle <sup>1)</sup>									
	2.3	96		08.94	10.98	+ multi link axle <sup>1)</sup>									
	2.3 T	121		08.94	10.98	+ multi link axle <sup>1)</sup>									
	2.3 T	126		08.95	10.98	+ multi link axle <sup>1)</sup>									
	2.3 ti	99		01.95	10.98	+ multi link axle <sup>1)</sup>									
	2.4 TD Intercooler	90		08.94	10.98	+ multi link axle <sup>1)</sup>									
<b>VOLVO 960 I Saloon (90-94)</b>															
	2.0	103		09.90	08.93	+ multi link axle <sup>1)</sup>	G1020955			21385 13,0 /S	LUC				
	2.0	140		08.90	09.93	+ multi link axle <sup>1)</sup>									
	2.4 TD Intercooler	85		09.91	07.94	+ multi link axle <sup>1)</sup>									
	2.9	150		08.90	07.94	+ multi link axle <sup>1)</sup>									
<b>VOLVO 960 I Estate (90-94)</b>															
	2.0	103		09.90	08.93	+ multi link axle <sup>1)</sup>	G1020955			21385 13,0 /S	LUC				
	2.0	140		08.90	09.93	+ multi link axle <sup>1)</sup>									
	2.4 TD Intercooler	85		09.91	07.94	+ multi link axle <sup>1)</sup>									
	2.8	108		09.90	05.92	+ multi link axle <sup>1)</sup>									
	2.8	115		09.90	05.92	+ multi link axle <sup>1)</sup>									
	2.9	150		08.90	07.94	+ multi link axle <sup>1)</sup>									
<b>VOLVO 960 II Saloon (94-96)</b>															
	2.5	125		08.94	12.96	+ multi link axle <sup>1)</sup>	G1020955			21385 13,0 /S	LUC				
	2.9	150		08.94	12.96	+ multi link axle <sup>1)</sup>									
<b>VOLVO 960 II Estate (94-96)</b>															
	2.5	125		08.94	12.96	+ multi link axle <sup>1)</sup>	G1020955			21385 13,0 /S	LUC				
	2.9	150		08.94	12.96	+ multi link axle <sup>1)</sup>									
<b>VOLVO C30 Coupe (06-12)</b>															
	1.6	74		09.06	12.12		G1020622		+ 15"/16" wheel <sup>2)</sup>	23723 18,1 +	ATE				
	1.6 D	80		09.06	12.12										
	1.6 D Efficiency	77		09.08	12.12										
	1.6 D2	84		10.10	12.12										
	1.8	92		09.06	12.12										
	1.8 FlexiFuel	92		04.07	12.12										
	2.0	107		09.06	12.12										
	2.0 D	100		09.06	12.12										
	2.0 D3	110		10.10	12.12										
	2.0 D4	130		10.10	12.12										
	2.4 D5	120		10.06	12.12										
	2.4 D5	132		09.06	12.12										
	2.4 i	125		09.06	12.12										
	2.5 T5	162		09.06	12.12										
	2.5 T5	169		03.07	12.12										
	Electric	82		12.10	12.12										
	1.6	74		09.06	12.12		G2125117 G2125162		+ 15" wheel <sup>3)</sup> + 16" wheel <sup>4)</sup>	278 25,0 23,0 V L + C 300 25,0 23,0 V L + C					
	1.6 D	80		09.06	12.12										
	1.6 D Efficiency	77		09.08	12.12										
	1.6 D2	84		10.10	12.12										
	1.8	92		09.06	12.12										
	1.8 FlexiFuel	92		04.07	12.12										

<sup>1)</sup> + assale Multi-link / + essieu multi-link / + eje Multi-Link / + Multi-Link-Achse  
<sup>2)</sup> + ruota 15"/16" / + roue 15"/16" / + rueda 15"/16" / + 15"/16" Rad  
<sup>3)</sup> + ruota 15" / + roue 15" / + rueda 15" / + 15" Rad  
<sup>4)</sup> + ruota 16" / + roue 16" / + rueda 16" / + 16" Rad

								
<b>VOLVO C30 Coupe (06-12)</b>								
	2.0 2.0 D 2.0 D3 2.0 D4 2.4 D5 2.4 D5 2.4 i 2.5 T5 2.5 T5 Electric	107 100 110 130 120 132 125 162 169 82		09.06 09.06 10.10 10.10 10.06 09.06 09.06 09.06 03.07 12.10	12.12 12.12 12.12 12.12 12.12 12.12 12.12 12.12 12.12 12.12	G2125117 G2125162	+ 15" wheel 1) + 16" wheel 2)	278 25,0 23,0 V L +C 300 25,0 23,0 V L +C
	1.6 1.6 D 1.6 D Efficiency 1.6 D2 1.8 1.8 FlexiFuel 2.0 2.0 D 2.0 D3 2.0 D4 2.4 D5 2.4 D5 2.4 i 2.5 T5 2.5 T5	74 80 77 84 92 92 107 100 110 130 120 132 125 162 169		09.06 09.06 09.08 10.10 09.06 04.07 09.06 09.06 10.10 10.10 10.10 10.06 09.06 09.06 09.06 03.07	12.12 12.12 12.12 12.12 12.12 12.12 12.12 12.12 12.12 12.12 12.12 12.12 12.12 12.12 12.12	G1020727		23482 16,6 + ATE
	1.6 1.6 D 1.6 D Efficiency 1.6 D2 1.8 1.8 FlexiFuel 2.0 2.0 D 2.0 D3 2.0 D4 2.4 D5 2.4 D5 2.4 i 2.5 T5 2.5 T5	74 80 77 84 92 92 107 100 110 130 120 132 125 162 169		09.06 09.06 09.08 10.10 09.06 04.07 09.06 09.06 10.10 10.10 10.10 10.06 09.06 09.06 09.06 03.07	12.12 12.12 12.12 12.12 12.12 12.12 12.12 12.12 12.12 12.12 12.12 12.12 12.12 12.12 12.12	G2111158		280 11,0 9,0 +S +C
<b>VOLVO C70 Coupe (97-02)</b>								
	2.0 2.0 T 2.5 T 2.3 T5	132 166 142 176		03.97 03.97 03.97 03.97	12.98 12.98 12.98 12.98	G1020622 G1020622	+ 15"/16" wheel 3)	23723 18,1 + ATE
	2.0 2.0 T 2.0 T 2.5 2.5 2.5 T 2.3 T5	132 120 166 121 125 142 176		01.99 03.00 01.99 09.99 11.99 01.99 01.99	09.02 09.02 09.02 09.02 09.02 09.02 09.02	G1020956 G1020956	+ 15"/16" wheel 3)	21273 19,5 +WD ATE
	2.0 2.0 T 2.0 T 2.3 T5 2.5 2.5 2.5 T	132 120 166 176 121 125 142		03.97 03.00 03.97 03.97 03.99 11.99 03.97	09.02 09.02 09.02 09.02 09.02 09.02 09.02	G1020510 G1020510	+ 15"/16" wheel 3)	20755 15,1 ATE
<b>VOLVO C70 I Convertible (98-06)</b>								
	2.0 2.0 T 2.4 T 2.5 2.5 T	132 120 147 125 142		03.98 03.00 07.02 06.98 03.98	02.06 02.06 02.06 02.06 02.06	G1020956 G1020956		21273 19,5 +WD ATE
	2.0 T 2.3 T5 2.3 T5	166 176 180		03.98 03.98 07.02	02.06 02.06 02.06	G1020956		21273 19,5 +WD ATE
	2.0 2.0 T 2.0 T 2.3 T5 2.3 T5 2.4 T 2.5 2.5 T	132 120 166 176 180 147 125 142		03.98 03.00 03.98 03.98 07.02 06.98 03.98	02.06 02.06 02.06 02.06 02.06 02.06 02.06	G1020510		20755 15,1 ATE
<b>VOLVO C70 II Convertible (06-13)</b>								
	2.0 D 2.0 D3 2.0 D4 2.4 2.4 D5 2.4 i	100 110 130 103 132 125		06.08 10.10 10.10 03.06 03.06 03.06	07.13 07.13 07.13 07.13 07.13 07.13	G1020622	- 17" wheel 4)	23723 18,1 + ATE
								

1) + ruota 15" / + roue 15" / + rueda 15" / + 15" Rad

2) + ruota 16" / + roue 16" / + rueda 16" / + 16" Rad

3) + ruota 15"/16" / + roue 15"/16" / + rueda 15"/16" / + 15"/16" Rad

4) - ruota 17" / - roue 17" / - rueda 17" / - 17" Rad





**VOLVO C70 II Convertible (06-13)**















	2.5 T5	162	03.06	07.13	- (USA) J	G1020622	- 17" wheel 1)	23723 18,1 +	ATE
	2.5 T5	169	03.07	07.13	- (USA) J				
	2.0 D3	110	10.10	07.13		G1020772	+ 17" wheel 2)	23912 18,6 +	ATE
	2.0 D4	130	10.10	07.13					
	2.5 T5	162	03.06	07.13					
2.5 T5	169	03.07	07.13						
	2.0 D3	110	10.10	07.13		G2125117 G2125162	+ 15" wheel 3)	278 25,0 23,0 V L +C 300 25,0 23,0 V L +C	
	2.0 D4	130	10.10	07.13					
	2.4	103	03.06	07.13					
	2.4 D5	132	03.06	07.13					
	2.4 i	125	03.06	07.13					
	2.5 T5	162	03.06	07.13					
	2.5 T5	169	03.07	07.13					
	2.0 D	100	06.08	07.13		G1020727		23482 16,6 +	ATE
	2.0 D3	110	10.10	07.13					
	2.0 D4	130	10.10	07.13					
	2.4	103	03.06	07.13					
	2.4 D5	132	03.06	07.13					
	2.4 i	125	03.06	07.13					
	2.5 T5	162	03.06	07.13					
	2.5 T5	169	03.07	07.13					
	2.0 D	100	06.08	07.13		G2111158		280 11,0 9,0 +S +C	
	2.0 D3	110	10.10	07.13					
	2.0 D4	130	10.10	07.13					
	2.4	103	03.06	07.13					
	2.4 D5	132	03.06	07.13					
	2.4 i	125	03.06	07.13					
	2.5 T5	162	03.06	07.13					
	2.5 T5	169	03.07	07.13					

**VOLVO S40 I (95-03)**

	1.6	77	09.95	08.97		G1020457		21920 14,6 /NW/Acc/S	LUC
	1.8 (1731)	85	07.95	08.97					
	1.9 T4	147	05.97	08.97					
	1.9 TD	66	07.95	08.97					
	2.0	100	07.95	08.97					
	2.0	103	07.95	08.97					
	2.0	103	07.95	08.97					
	1.6	77	09.97	08.99		G1020537		21983 17,2 /NW/Acc/S	LUC
	1.6	80	03.99	12.03					
	1.8 (1731)	85	09.97	08.99					
	1.8 (1783)	90	03.99	12.03					
	1.8 i (1834)	90	06.01	12.03					
	1.8 i (1834)	92	03.98	12.03					
	1.9 DI	70	03.99	07.00					
	1.9 DI	75	07.00	12.03					
	1.9 DI	85	07.00	12.03					
	1.9 T4	147	09.97	07.00					
	1.9 TD	66	09.97	08.99					
	2.0	100	09.97	12.03					
	2.0	103	09.97	08.99					
	2.0 T	118	10.97	07.00					
	2.0 T	120	06.01	12.03					
	2.0 T	121	07.00	06.01					
	2.0 T4	147	07.00	12.03					
	1.6	77	09.95	08.99		G1020458		21861 15,2 /NW/S	LUC
	1.6	80	03.99	12.03					
	1.8 (1731)	85	07.95	08.99					
	1.8 (1783)	90	03.99	12.03					
	1.8 i (1834)	90	06.01	12.03					
	1.8 i (1834)	92	03.98	12.03					
	1.9 DI	70	03.99	07.00					
	1.9 DI	75	07.00	12.03					
	1.9 DI	85	07.00	12.03					
	1.9 T4	147	05.97	07.00					
	1.9 TD	66	07.95	08.99					
	2.0	100	07.95	12.03					
	2.0	103	07.95	08.99					
	2.0 T	118	10.97	07.00					
	2.0 T	120	06.01	12.03					
	2.0 T	121	07.00	06.01					
	2.0 T4	147	07.00	12.03					
	1.6	77	09.95	08.99		G2110229		260 10,0 8,4 +C	
	1.6	80	03.99	12.03					
	1.8 (1731)	85	07.95	08.99					
	1.8 (1783)	90	03.99	12.03					
	1.8 i (1834)	90	06.01	12.03					
	1.8 i (1834)	92	03.98	12.03					
	1.9 DI	70	03.99	07.00					
	1.9 DI	75	07.00	12.03					
	1.9 DI	85	07.00	12.03					
	1.9 T4	147	05.97	07.00					
	1.9 TD	66	07.95	08.99					
	2.0	100	07.95	12.03					
	2.0	103	07.95	08.99					
	2.0 T	118	10.97	07.00					
	2.0 T	120	06.01	12.03					
	2.0 T	121	07.00	06.01					
	2.0 T4	147	06.01	12.03					

1) - ruota 17" / - roue 17" / - rueda 17" / - 17" Rad  
 2) + ruota 17" / + roue 17" / + rueda 17" / + 17" Rad  
 3) + ruota 15" / + roue 15" / + rueda 15" / + 15" Rad  
 4) + ruota 16" / + roue 16" / + rueda 16" / + 16" Rad



										
<b>VOLVO S40 I (95-03)</b>										
	2.0 T 2.0 T4	121 147		07.00 07.00	06.01 12.03	G2110229	260 10,0 8,4 +C			
<b>VOLVO S40 II (04-12)</b>										
	1.6 D 1.6 D 1.6 D2 1.6 i 1.8 1.8 FlexiFuel 2.0 D 2.0 D3 2.0 D4 2.0 D4 2.0 FlexiFuel 2.0 i 2.4 2.4 2.4 4X4 2.4 D5 2.5 T5 2.5 T5 2.5 T5 AWD 2.5 T5 AWD	80 81 84 74 92 92 100 110 96 130 107 107 103 125 125 132 162 169 162 169		04.07 01.05 10.10 01.05 04.04 04.07 01.04 10.10 07.05 10.10 10.06 10.06 01.04 01.04 08.06 03.06 01.04 03.07 04.04 03.07	05.12 05.12	- (USA) ↓ - (USA) ↓	G1020622 G1020772	- 17" wheel 1) + 17" wheel 2)	23723 18,1 + 23912 18,6 +	ATE ATE
	1.6 D 1.6 D 1.6 i 1.8 1.8 FlexiFuel 2.0 D 2.0 D4 2.0 FlexiFuel 2.0 i 2.4 2.4 2.4 4X4 2.4 D5 2.5 T5 2.5 T5 2.5 T5 AWD 2.5 T5 AWD	80 81 74 92 92 100 96 107 107 103 125 125 132 162 169 162 169		04.07 01.05 01.05 04.04 04.07 01.04 07.05 10.06 10.06 01.04 01.04 08.06 03.06 01.04 03.07 04.04 03.07	05.12 05.12 05.12 05.12 05.12 05.12 05.12 05.12 05.12 05.12 05.12 05.12 05.12 05.12 05.12 05.12 05.12 05.12	G2125117 G2125162	+ 15" wheel 3) + 16" wheel 4)	278 25,0 23,0 V L +C 300 25,0 23,0 V L +C		
	1.6 D2 2.0 D3 2.0 D4	84 110 130		10.10 10.10 10.10	05.12 05.12 05.12	G2125117 G2125162	+ 15" wheel 3) + 16" wheel 4)	278 25,0 23,0 V L +C 300 25,0 23,0 V L +C		
	1.6 D 1.6 D 1.6 D2 1.6 i 1.8 1.8 FlexiFuel 2.0 D 2.0 D3 2.0 D4 2.0 D4 2.0 FlexiFuel 2.0 i 2.4 2.4 2.4 4X4 2.4 D5 2.5 T5 2.5 T5 2.5 T5 AWD 2.5 T5 AWD	80 81 84 74 92 92 100 110 96 130 107 107 103 125 125 132 162 169 162 169		04.07 01.05 10.10 01.05 04.04 04.07 01.04 10.10 07.05 10.10 10.06 10.06 01.04 01.04 08.06 03.06 01.04 03.07 04.04 03.07	05.12 05.12	G1020727		23482 16,6 +	ATE	
	1.6 D 1.6 D 1.6 D2 1.6 i 1.8 1.8 FlexiFuel 2.0 D 2.0 D3 2.0 D4 2.0 D4 2.0 FlexiFuel 2.0 i 2.4 2.4 2.4 4X4 2.4 D5 2.5 T5 2.5 T5 2.5 T5 AWD 2.5 T5 AWD	80 81 84 74 92 92 100 110 96 130 107 107 103 125 125 132 162 169 162 169		04.07 01.05 10.10 01.05 04.04 04.07 01.04 10.10 07.05 10.10 10.06 10.06 01.04 01.04 08.06 03.06 01.04 03.07 04.04 03.07	05.12 05.12	G2111158		280 11,0 9,0 +S +C		

1) - ruota 17" / - roue 17" / - rueda 17" / - 17" Rad  
2) + ruota 17" / + roue 17" / + rueda 17" / + 17" Rad  
3) + ruota 15" / + roue 15" / + rueda 15" / + 15" Rad  
4) + ruota 16" / + roue 16" / + rueda 16" / + 16" Rad



VOLVO S60 I (00-09)															
	2.0 T	132		09.01	01.09	G1020578 G1020694		- 17" wheel 1) + 17" wheel 2)	23073 18,8 + 23950 19,5 +	ATE ATE					
	2.3 T5	184		08.00	04.04										
	2.3 T5	195		07.00	09.02										
	2.4	103		11.00	01.09										
	2.4	125		11.00	01.09										
	2.4 Bi-Fuel	103		06.02	01.09										
	2.4 D	93		09.05	01.09										
	2.4 D	96		12.01	01.09										
	2.4 D5	120		07.01	01.09										
	2.4 D5	136		09.05	01.09										
	2.4 T	147		11.00	01.09										
	2.4 T AWD	147		11.01	01.09										
	2.4 T5	191		04.04	01.09										
	2.5 T	154		02.04	01.09										
2.5 T AWD	154		04.04	01.09											
	2.0 T	132		09.01	01.09	G1020480			23076 17,5 +	ATE					
	2.3 T5	184		08.00	04.04										
	2.3 T5	195		07.00	09.02										
	2.4	103		11.00	01.09										
	2.4	125		11.00	01.09										
	2.4 Bi-Fuel	103		06.02	01.09										
	2.4 D	93		09.05	01.09										
	2.4 D	96		12.01	01.09										
	2.4 D5	120		07.01	01.09										
	2.4 D5	136		09.05	01.09										
	2.4 T	147		11.00	01.09										
	2.4 T AWD	147		11.01	01.09										
	2.4 T5	191		04.04	01.09										
	2.5 T	154		02.04	01.09										
2.5 T AWD	154		04.04	01.09											
VOLVO S60 II (10-)															
	1.6 D DRIVE	84		01.11		G1020889		+ 16" wheel 3)	24123 20,3 +	ATE					
	2.0 T	149		04.10											
	D2	84		04.13											
	D3	100		05.12											
	D3	120		04.10											
	D4	120		05.12											
	D5	151		04.10											
	D5	158		06.11											
	D5 AWD	151		04.10											
	D5 AWD	158		06.11											
	T3	110		04.10											
	T4	132		04.10											
	T4F	132		04.11											
	T5	176		04.10											
	T6 AWD	224		04.10		G1020889		+ 16" wheel 3)	24123 20,3 +	ATE					
	1.6 D DRIVE	84		01.11											
	2.0 T	149		04.10											
	D2	84		04.13											
	D3	100		05.12											
	D3	120		04.10											
	D4	120		05.12											
	D5	151		04.10											
	D5	158		06.11											
	D5 AWD	151		04.10											
	D5 AWD	158		06.11											
	T3	110		04.10											
	T4	132		04.10											
	T4F	132		04.11											
T5	176		04.10												
	T6 AWD	224		04.10		G1201009		+ 17" wheel 2)	24142 20,6 +	ATE					
	1.6 D DRIVE	84		01.11											
	2.0 T	149		04.10											
	D2	84		04.13											
	D3	100		05.12											
	D3	120		04.10											
	D4	120		05.12											
	D5	151		04.10											
	D5	158		06.11											
	D5 AWD	151		04.10											
	D5 AWD	158		06.11											
	T3	110		04.10											
	T4	132		04.10											
	T4F	132		04.11											
T5	176		04.10												
	1.6 D DRIVE	84	103486	01.11		G2128154		+ 16" wheel 3)	300 28,0 26,0 V L +S +C						
	2.0 T	149	103486	04.10											
	D2	84	103486	04.13											
	D3	100	103486	05.12											
	D3	120	103486	04.10											
	D4	120	103486	05.12											
	D5	151	103486	04.10											
	D5	158	103486	06.11											
	D5 AWD	151	103486	04.10											
	D5 AWD	158	103486	06.11											
	T3	110	103486	04.10											
	T4	132	103486	04.10											
	T4F	132	103486	04.11											
	T5	176	103486	04.10											
T6 AWD	224	103486	04.10												
	1.6 D DRIVE	84		01.11		G1020787		- ventilated discs 4)	24496 17,3 /Acc/S	LUC					
	2.0 T	149		04.10											
	D2	84		04.13											
	D3	120		04.10											
	D4	120		05.12											
	D5	151		04.10											
	D5	158		06.11											
	D5 AWD	151		04.10											
	D5 AWD	158		06.11											
	T3	110		04.10											
	1) - ruota 17" / - roue 17" / - rueda 17" / - 17" Rad 2) + ruota 17" / + roue 17" / + rueda 17" / + 17" Rad 3) + ruota 16" / + roue 16" / + rueda 16" / + 16" Rad 4) - dischi ventilati / - disques ventilés / - disco ventilado / - belüftete Scheiben														



VOLVO S60 II (10-)									
	T4	132		04.10	- (GM) (USA)	G1020787	- ventilated discs <sup>1)</sup>	24496 17,3 /Acc/S	LUC
	T4F	132		04.11	- (GM) (USA)				
	T5	176		04.10	- (GM) (USA)				
	T6 AWD	224		04.10	- (GM) (USA)				
	1.6 D DRIVE	84		01.11					
	2.0 T	149		04.10					
	D2	84		04.13					
	D3	120		04.10					
	D4	120		05.12					
	D5	151		04.10					
D5	158		06.11						
D5 AWD	151		04.10						
D5 AWD	158		06.11						
T3	110		04.10						
T4	132		04.10						
T4F	132		04.11						
T5	176		04.10						
T6 AWD	224		04.10						

VOLVO S70 (97-00)									
	2.0	93		01.97	11.00	G1020956		21273 19,5 +/WD	ATE
	2.0	105		01.97	11.00				
	2.0 20V	120		01.97	11.00				
	2.0 20V	132		01.97	11.00				
	2.0 T	155		01.97	11.00				
	2.0 T	166		01.97	11.00				
	2.3	195		04.99	09.00				
	2.4	103		08.99	11.00				
	2.4	125		01.97	11.00				
	2.4 AWD			10.98	05.99				
	2.4 AWD	103		04.99	09.00				
	2.4 AWD	106		11.96	05.99				
	2.4 AWD	142		11.96	09.00				
	2.4 Blu-Fuel	103		07.97	09.00				
	2.4 T	142		01.97	11.00				
	2.5	106		01.97	11.00				
	2.5	121		06.98	11.00				
	2.5 Bifuel	103		07.99	11.00				
	2.5 Bifuel	106		10.98	11.00				
	2.5 TDI	103		01.97	11.00				
2.5 TDi AWD	103		10.99	09.00					
2.3 T	184		01.97	11.00					
2.3 T5	176		01.97	11.00					
	2.0	93		01.97	11.00	G1020510		20755 15,1	ATE
	2.0	105		01.97	11.00				
	2.0 20V	120		01.97	11.00				
	2.0 20V	132		01.97	11.00				
	2.0 T	155		01.97	11.00				
	2.0 T	166		01.97	11.00				
	2.3	195		04.99	09.00				
	2.3 T	184		01.97	11.00				
	2.3 T5	176		01.97	11.00				
	2.4	103		08.99	11.00				
	2.4	125		01.97	11.00				
	2.4 AWD			10.98	05.99				
	2.4 AWD	103		04.99	09.00				
	2.4 AWD	106		11.96	05.99				
	2.4 AWD	142		11.96	09.00				
	2.4 Blu-Fuel	103		07.97	09.00				
	2.4 T	142		01.97	11.00				
	2.5	106		01.97	11.00				
	2.5	121		06.98	11.00				
	2.5 Bifuel	103		07.99	11.00				
2.5 Bifuel	106		10.98	11.00					
2.5 TDI	103		01.97	11.00					
2.5 TDi AWD	103		10.99	09.00					

VOLVO S80 I (98-06)									
	2.0	120		06.98	02.06	G1020578 G1020694	- 17" wheel <sup>3)</sup> + 17" wheel <sup>4)</sup>	23073 18,8 + 23950 19,5 +	ATE ATE
	2.0 T	132		12.99	02.06				
	2.0 T	166		06.98	02.06				
	2.4	103		01.99	02.06				
	2.4	125		01.99	02.06				
	2.4 Bi-Fuel	103		09.01	02.06				
	2.4 D	96		10.01	02.06				
	2.4 D5	120		08.01	02.06				
	2.4 T	147		06.00	02.06				
	2.5 T	154		07.03	02.06				
	2.5 TDI	103		01.99	02.06				
	2.9	147		03.99	02.06				
	2.9	150		05.98	02.06				
	3.0	144		06.01	02.06				
	2.8 T6	200		05.98	02.06				
	3.0 T6	200		06.01	02.06				

1) - dischi ventilati / - disques ventilés / - disco ventilado / - belüftete Scheiben  
2) + dischi ventilati / + disques ventilés / + disco ventilado / + belüftete Scheiben  
3) - ruota 17" / - roue 17" / - rueda 17" / - 17" Rad  
4) + ruota 17" / + roue 17" / + rueda 17" / + 17" Rad















VOLVO S80 I (98-06)										
	2.0	120		06.98	02.06		G1020480		23076 17,5 +	ATE
	2.0 T	132		12.99	02.06					
	2.0 T	166		06.98	02.06					
	2.4	103		01.99	02.06					
	2.4	125		01.99	02.06					
	2.4 Bi-Fuel	103		09.01	02.06					
	2.4 D	96		10.01	02.06					
	2.4 D5	120		08.01	02.06					
	2.4 T	147		06.00	02.06					
	2.5 T	154		07.03	02.06					
	2.5 TDI	103		01.99	02.06					
	2.8 T6	200		05.98	02.06					
	2.9	147		03.99	02.06					
	2.9	150		05.98	02.06					
	3.0	144		06.01	02.06					
	3.0 T6	200		06.01	02.06					

VOLVO S80 II (06-)										
	1.6 D DRIVE			01.10			G1020889	+ 16" wheel <sup>1)</sup>	24123 20,3 +	ATE
	2.0	107		09.07						
	2.0 D	100		09.07						
	2.0 FlexiFuel	107		09.07						
	2.0 T	149		01.10						
	2.0 TDi	100		02.08						
	2.4 D	120		03.06						
	2.4 D	129		04.09						
	2.4 D5	136		03.06						
	2.4 D5	151		11.08						
	2.4 D5	158		06.11						
	2.4 D5 AWD	136		01.07						
	2.4 D5 AWD	151		01.10						
	2.4 D5 AWD	158		06.11						
	2.5 T	147		03.06						
	2.5 T	170		01.10						
	2.5 T AWD	147		10.06						
	2.5 T FlexFuel	147		04.08						
	2.5 T FlexiFuel	170		01.10						
	3.0 T6 AWD	210		01.07						
	3.2			03.06						
	3.2 AWD			01.07						
	D2	84		04.13						
	D3	120		01.10						
	T4	132		10.10						
	T4F	132		05.11						
	T5	177		10.10						
	4.4 V8 AWD	232		03.06			G1020889	+ 16" wheel <sup>1)</sup>	24123 20,3 +	ATE
	T6 AWD	224		10.10						
	1.6 D DRIVE			01.10			G1201009	+ 17"/18" wheel <sup>2)</sup>	24142 20,6 +	ATE
	2.0	107		09.07						
	2.0 D	100		09.07						
	2.0 FlexiFuel	107		09.07						
	2.0 T	149		01.10						
	2.0 TDi	100		02.08						
	2.4 D	120		03.06						
	2.4 D	129		04.09						
	2.4 D5	136		03.06						
	2.4 D5	151		11.08						
	2.4 D5	158		06.11						
	2.4 D5 AWD	136		01.07						
	2.4 D5 AWD	151		01.10						
	2.4 D5 AWD	158		06.11						
	2.5 T	147		03.06						
	2.5 T	170		01.10						
	2.5 T AWD	147		10.06						
	2.5 T FlexFuel	147		04.08						
	2.5 T FlexiFuel	170		01.10						
	3.0 T6 AWD	210		01.07						
	3.2			03.06						
	3.2 AWD			01.07						
	D2	84		04.13						
	D3	120		01.10						
	T4	132		10.10						
	T4F	132		05.11						
	T5	177		10.10						
	4.4 V8 AWD	232		03.06			G1201009	+ 17"/18" wheel <sup>2)</sup>	24142 20,6 +	ATE
	T6 AWD	224		10.10						
	1.6 D DRIVE		155829	01.10			G2128154	+ 16" wheel <sup>1)</sup>	300 28,0 26,0 V L + S + C	
	2.0	107	155829	09.07						
	2.0 D	100	155829	09.07						
	2.0 FlexiFuel	107	155829	09.07						
	2.0 T	149	155829	01.10						
	2.0 TDi	100	155829	02.08						
	2.4 D	120	155829	03.06						
	2.4 D	129	155829	04.09						
	2.4 D5	136	155829	03.06						
	2.4 D5	151	155829	11.08						
	2.4 D5	158	155829	06.11						

<sup>1)</sup> + ruota 16" / + roue 16" / + rueda 16" / + 16" Rad

<sup>2)</sup> + ruota 17"/18" / + roue 17"/18" / + rueda 17"/18" / + 17"/18" Rad

												
<b>VOLVO S80 II (06-)</b>												
	2.4 D5 AWD	136	155829	01.07	<b>G2128154</b>	+ 16" wheel <sup>1)</sup>		300 28,0 26,0 V L +S +C				
	2.4 D5 AWD	151	155829	01.10								
	2.4 D5 AWD	158	155829	06.11								
	2.5 T	147	155829	03.06								
	2.5 T	170	155829	01.10								
	2.5 T AWD	147	155829	10.06								
	2.5 T FlexFuel	147	155829	04.08								
	2.5 T FlexiFuel	170	155829	01.10								
	3.0 T6 AWD	210	155829	01.07								
	3.2		155829	03.06								
	3.2 AWD		155829	01.07								
	4.4 V8 AWD	232	155829	03.06								
	D2	84	155829	04.13								
	D3	120	155829	01.10								
	T4	132	155829	10.10								
	T4F	132	155829	05.11								
	T5	177	155829	10.10								
	T6 AWD	224	155829	10.10								
	1.6 D DRIVE			01.10					<b>G1201135</b>	- electric parking brake <sup>2)</sup>	24537 15,8 /Acc/S	<b>LUC</b>
	2.0	107		09.07								
	2.0 D	100		09.07								
	2.0 FlexiFuel	107		09.07								
	2.0 T	149		01.10								
	2.0 TDi	100		02.08								
	2.4 D	120		03.06								
	2.4 D	129		04.09								
	2.4 D5	136		03.06								
	2.4 D5	151		11.08								
	2.4 D5	158		06.11								
	2.4 D5 AWD	136		01.07								
	2.4 D5 AWD	151		01.10								
	2.4 D5 AWD	158		06.11								
	2.5 T	147		03.06								
	2.5 T	170		01.10								
	2.5 T AWD	147		10.06								
	2.5 T FlexFuel	147		04.08								
	2.5 T FlexiFuel	170		01.10								
	3.0 T6 AWD	210		01.07								
	3.2			03.06								
	3.2 AWD			01.07								
	4.4 V8 AWD	232		03.06								
	D2	84		04.13								
	D3	120		01.10								
	T4	132		10.10								
	T4F	132		05.11								
	T5	177		10.10								
	T6 AWD	224		10.10								
	1.6 D DRIVE			01.10	<b>G1020787</b>	+ electric parking brake <sup>4)</sup>	24496 17,3 /Acc/S	<b>LUC</b>				
	2.0	107		09.07								
	2.0 D	100		09.07								
	2.0 FlexiFuel	107		09.07								
	2.0 T	149		01.10								
	2.0 TDi	100		02.08								
	2.4 D	120		03.06								
	2.4 D	129		04.09								
	2.4 D5	136		03.06								
	2.4 D5	151		11.08								
	2.4 D5	158		06.11								
	2.4 D5 AWD	136		01.07								
	2.4 D5 AWD	151		01.10								
	2.4 D5 AWD	158		06.11								
	2.5 T	147		03.06								
	2.5 T	170		01.10								
	2.5 T AWD	147		10.06								
	2.5 T FlexFuel	147		04.08								
	2.5 T FlexiFuel	170		01.10								
	3.0 T6 AWD	210		01.07								
	3.2			03.06								
	3.2 AWD			01.07								
	4.4 V8 AWD	232		03.06								
	D2	84		04.13								
	D3	120		01.10								
	T4	132		10.10								
	T4F	132		05.11								
	T5	177		10.10								
	T6 AWD	224		10.10								
	1.6 D DRIVE			01.10	<b>G1020900</b>	+ electric parking brake <sup>4)</sup>	24496 17,3 /Acc/S	<b>LUC</b>				
	2.0	107		09.07								
	2.0 D	100		09.07								
	2.0 FlexiFuel	107		09.07								
	2.0 T	149		01.10								
	2.0 TDi	100		02.08								
	2.4 D	120		03.06								
	2.4 D	129		04.09								
	2.4 D5	136		03.06								
	2.4 D5	151		11.08								
	2.4 D5	158		06.11								
	2.4 D5	136		03.06								
	2.4 D5	151		11.08								
	2.4 D5	158		06.11								
	2.4 D5	136		03.06								
	2.4 D5	151		11.08								
	2.4 D5	158		06.11								

<sup>1)</sup> + ruota 16" / + roue 16" / + rueda 16" / + 16" Rad

<sup>2)</sup> - freno a mano elettrico / - frein à main électrique / - freno de mano eléctrico / - elektrishe Feststellbremse

<sup>3)</sup> + dischi massiccio / + disques massive / + disco macizo / + massive Scheiben

<sup>4)</sup> + freno a mano elettrico / + frein à main électrique / + freno de mano eléctrico / + elektrishe Feststellbremse

<sup>5)</sup> + dischi ventilati / + disques ventilés / + disco ventilado / + belüftete Scheiben

<b>VOLVO S80 II (06-)</b>															
	2.4 D5 AWD	136		01.07		+ ventilated discs <sup>1)</sup>		G1020900		+ electric parking brake <sup>2)</sup>		24496 17,3 /Acc/S	LUC		
	2.4 D5 AWD	151		01.10		+ ventilated discs <sup>1)</sup>									
	2.4 D5 AWD	158		06.11		+ ventilated discs <sup>1)</sup>									
	2.5 T	147		03.06		+ ventilated discs <sup>1)</sup>									
	2.5 T	170		01.10		+ ventilated discs <sup>1)</sup>									
	2.5 T AWD	147		10.06		+ ventilated discs <sup>1)</sup>									
	2.5 T FlexFuel	147		04.08		+ ventilated discs <sup>1)</sup>									
	2.5 T FlexiFuel	170		01.10		+ ventilated discs <sup>1)</sup>									
	3.0 T6 AWD	210		01.07		+ ventilated discs <sup>1)</sup>									
	3.2			03.06		+ ventilated discs <sup>1)</sup>									
	3.2 AWD			01.07		+ ventilated discs <sup>1)</sup>									
	4.4 V8 AWD	232		03.06		+ ventilated discs <sup>1)</sup>									
	D2	84		04.13		+ ventilated discs <sup>1)</sup>									
	D3	120		01.10		+ ventilated discs <sup>1)</sup>									
T4	132		10.10		+ ventilated discs <sup>1)</sup>										
T4F	132		05.11		+ ventilated discs <sup>1)</sup>										
T5	177		10.10		+ ventilated discs <sup>1)</sup>										
T6 AWD	224		10.10		+ ventilated discs <sup>1)</sup>										
<b>VOLVO S90 (97-98)</b>															
	2.5	125		11.96	10.98			G1020955				21385 13,0 /S	LUC		
	2.5	132		11.96	10.97										
	2.9	132		01.97	05.98										
	2.9	150		01.97	05.98										
<b>VOLVO V40 (95-04)</b>															
	1.6	77		12.95	08.97			G1020457				21920 14,6 /N/Acc/S	LUC		
	1.8 (1731)	85		07.95	08.97										
	1.9 T4	147		05.97	08.97										
	1.9 TD	66		07.95	08.97										
	2.0	100		07.95	08.97										
	2.0	103		07.95	08.97										
	1.6	77		09.97	08.99										
	1.6	80		03.99	07.04										
1.8 (1731)	85		09.97	08.99											
1.8 (1783)	90		03.99	07.04											
1.8 i (1834)	90		06.01	07.04											
1.8 i (1834)	92		03.98	07.04											
1.9 DI	70		03.99	07.00											
1.9 DI	75		07.00	07.04											
1.9 DI	85		07.00	07.04											
1.9 T4	147		09.97	07.00											
1.9 TD	66		09.97	08.99											
2.0	100		09.97	07.04											
2.0	103		09.97	08.99											
2.0 T	118		10.97	07.00											
2.0 T	120		06.01	07.04											
2.0 T	121		07.00	06.01											
2.0 T4	147		07.00	04.04											
	1.6	77		12.95	08.99			G1020458				21861 15,2 /N/W/S	LUC		
	1.6	80		03.99	07.04										
	1.8 (1731)	85		07.95	08.99										
	1.8 (1783)	90		03.99	07.04										
	1.8 i (1834)	90		06.01	07.04										
	1.8 i (1834)	92		03.98	07.04										
	1.9 DI	70		03.99	07.00										
	1.9 DI	75		07.00	07.04										
	1.9 DI	85		07.00	07.04										
	1.9 T4	147		05.97	07.00										
	1.9 TD	66		07.95	08.99										
	2.0	100		07.95	07.04										
	2.0	103		07.95	08.99										
	2.0 T	118		10.97	07.00										
2.0 T	120		06.01	07.04											
2.0 T	121		07.00	06.01											
2.0 T4	147		07.00	04.04											
	1.6	77		12.95	08.99			G2110229				260 10,0 8,4 +C			
	1.6	80		03.99	07.04										
	1.8 (1731)	85		07.95	08.99										
	1.8 (1783)	90		03.99	07.04										
	1.8 i (1834)	90		06.01	07.04										
	1.8 i (1834)	92		03.98	07.04										
	1.9 DI	70		03.99	07.00										
	1.9 DI	75		07.00	07.04										
	1.9 DI	85		07.00	07.04										
	1.9 T4	147		05.97	07.00										
	1.9 TD	66		07.95	08.99										
	2.0	100		07.95	07.04										
	2.0	103		07.95	08.99										
	2.0 T	118		10.97	07.00										
2.0 T	120		06.01	07.04											
2.0 T	121		07.00	06.01											
2.0 T4	147		07.00	04.04											

<sup>1)</sup> + dischi ventilati / + disques ventilés / + disco ventilado / + belüftete Scheiben

<sup>2)</sup> + freno a mano elettrico / + frein à main électrique / + freno de mano eléctrico / + elektrische Feststellbremse



VOLVO V40 (12-)											
	D2	84		09.12				G1020622	+ 15"/16" wheel <sup>1)</sup>	23723 18,1 +	ATE
	D3	110		09.12							
	D4	130		09.12							
	T2 GTDi	88		03.13							
	T3 GTDi	110		09.12							
	T4	132		04.13							
	T4 GTDi	132		09.12							
	D2	84		09.12				G1020772	+ 17" wheel <sup>2)</sup>	23912 18,6 +	ATE
	D3	110		09.12							
	D4	130		09.12							
T2 GTDi	88		03.13								
T3 GTDi	110		09.12								
T4	132		04.13								
T4 AWD	132		04.13								
T4 GTDi	132		09.12								
T5	187		09.12								
T5 AWD	157		03.13								
T5 AWD	187		01.13								
	D3	110		09.12				G2111158		280 11,0 9,0 +S +C	
	D4	130		09.12							
	T2 GTDi	88		03.13							
	T3 GTDi	110		09.12							
	T4	132		04.13							
	T4 AWD	132		04.13							
	T4 GTDi	132		09.12							
	T5	187		09.12							
	T5 AWD	157		03.13							
	T5 AWD	187		01.13							
D2	84		09.12				G2111158	- ALU brake disc <sup>3)</sup>	280 11,0 9,0 +S +C		
VOLVO V50 (04-12)											
	1.6 D	80		04.07	05.12	- (USA) ↓		G1020622	- 17" wheel <sup>4)</sup>	23723 18,1 +	ATE
	1.6 D	81		01.05	05.12	- (USA) ↓		G1020772	+ 17" wheel <sup>2)</sup>	23912 18,6 +	ATE
	1.6 D2	84		01.10	05.12	- (USA) ↓					
	1.6 i	74		01.05	05.12	- (USA) ↓					
	1.8	92		04.04	05.12	- (USA) ↓					
	1.8 FlexiFuel	92		04.07	05.12	- (USA) ↓					
	2.0 D	100		04.04	05.12	- (USA) ↓					
	2.0 D3	110		10.10	05.12	- (USA) ↓					
	2.0 D4	130		10.10	05.12	- (USA) ↓					
	2.0 FlexiFuel	107		01.10	05.12	- (USA) ↓					
	2.0 i	107		10.06	05.12	- (USA) ↓					
	2.4	103		04.04	05.12	- (USA) ↓					
	2.4	125		04.04	05.12	- (USA) ↓					
	2.4 AWD	125		08.06	05.12	- (USA) ↓					
	2.4 D5	132		03.06	05.12	- (USA) ↓					
	2.4 Tdi	120		05.07	05.12	- (USA) ↓					
	2.5 T5	162		04.04	05.12	- (USA) ↓					
	2.5 T5	169		03.07	05.12	- (USA) ↓					
	2.5 T5 AWD	162		04.04	05.12	- (USA) ↓					
	2.5 T5 AWD	169		03.07	05.12	- (USA) ↓					
	1.6 D	80		04.07	05.12			G2125117	+ 15" wheel <sup>5)</sup>	278 25,0 23,0 V L +C	
	1.6 D	81		01.05	05.12			G2125162	+ 16" wheel <sup>6)</sup>	300 25,0 23,0 V L +C	
	1.6 i	74		01.05	05.12						
	1.8	92		04.04	05.12						
	1.8 FlexiFuel	92		04.07	05.12						
	2.0 D	100		04.04	05.12						
	2.0 FlexiFuel	107		01.10	05.12						
	2.0 i	107		10.06	05.12						
	2.4	103		04.04	05.12						
	2.4	125		04.04	05.12						
2.4 AWD	125		08.06	05.12							
2.4 D5	132		03.06	05.12							
2.4 Tdi	120		05.07	05.12							
2.5 T5	162		04.04	05.12							
2.5 T5	169		03.07	05.12							
2.5 T5 AWD	162		04.04	05.12							
2.5 T5 AWD	169		03.07	05.12							
	1.6 D2	84		01.10	05.12			G2125117	+ 15" wheel <sup>5)</sup>	278 25,0 23,0 V L +C	
	2.0 D3	110		10.10	05.12			G2125162	+ 16" wheel <sup>6)</sup>	300 25,0 23,0 V L +C	
	2.0 D4	130		10.10	05.12						
	1.6 D	80		04.07	05.12			G1020727		23482 16,6 +	ATE
	1.6 D	81		01.05	05.12						
	1.6 D2	84		01.10	05.12						
	1.6 i	74		01.05	05.12						
	1.8	92		04.04	05.12						
	1.8 FlexiFuel	92		04.07	05.12						
	2.0 D	100		04.04	05.12						
2.0 D3	110		10.10	05.12							
2.0 D4	130		10.10	05.12							
2.0 FlexiFuel	107		01.10	05.12							
2.0 i	107		10.06	05.12							
2.4	103		04.04	05.12							
2.4	125		04.04	05.12							
2.4 AWD	125		08.06	05.12							
2.4 D5	132		03.06	05.12							

<sup>1)</sup> + ruota 15"/16" / + roue 15"/16" / + rueda 15"/16" / + 15"/16" Rad

<sup>2)</sup> + ruota 17" / + roue 17" / + rueda 17" / + 17" Rad

<sup>3)</sup> - freno de ALU / - disque de frein ALU / - freno de ALU / - ALU Bremsscheibe

<sup>4)</sup> - ruota 17" / - roue 17" / - rueda 17" / - 17" Rad

<sup>5)</sup> + ruota 15" / + roue 15" / + rueda 15" / + 15" Rad

<sup>6)</sup> + ruota 16" / + roue 16" / + rueda 16" / + 16" Rad







VOLVO V50 (04-12)											
	2.4 Tdi	120		05.07	05.12			G1020727		23482 16,6 +	ATE
	2.5 T5	162		04.04	05.12						
	2.5 T5	169		03.07	05.12						
	2.5 T5 AWD	162		04.04	05.12						
	2.5 T5 AWD	169		03.07	05.12						
	1.6 D	80		04.07	05.12			G2111158		280 11,0 9,0 +S +C	
	1.6 D	81		01.05	05.12						
	1.6 D2	84		01.10	05.12						
	1.6 i	74		01.05	05.12						
	1.8	92		04.04	05.12						
	1.8 FlexiFuel	92		04.07	05.12						
	2.0 D	100		04.04	05.12						
	2.0 D3	110		10.10	05.12						
	2.0 D4	130		10.10	05.12						
	2.0 FlexiFuel	107		01.10	05.12						
	2.0 i	107		10.06	05.12						
	2.4	103		04.04	05.12						
	2.4	125		04.04	05.12						
	2.4 AWD	125		08.06	05.12						
	2.4 D5	132		03.06	05.12						
	2.4 Tdi	120		05.07	05.12						
	2.5 T5	162		04.04	05.12						
	2.5 T5	169		03.07	05.12						
	2.5 T5 AWD	162		04.04	05.12						
	2.5 T5 AWD	169		03.07	05.12						
VOLVO V60 (10-)											
	1.6 DRIVE	84		06.11				G1020889	+ 16" wheel <sup>1)</sup>	24123 20,3 +	ATE
	2.0 T	149		11.10							
	2.4 D5	158		06.11							
	2.4 D5 AWD	158		06.11							
	2.4 D6 Plug-in-Hybrid	158		11.12							
	D 3	100		10.12							
	D 3	120		11.10							
	D 5	151		11.10							
	D 5 AWD	151		11.10							
	T3	110		11.10							
	T4	132		11.10							
	T4F	132		04.11							
	T5	177		11.10							
	T 6 AWD	224		11.10				G1020889	+ 16" wheel <sup>1)</sup>	24123 20,3 +	ATE
	1.6 DRIVE	84		06.11				G1201009	+ 17" wheel <sup>2)</sup>	24142 20,6 +	ATE
	2.0 T	149		11.10							
	2.4 D5	158		06.11							
	2.4 D5 AWD	158		06.11							
	2.4 D6 Plug-in-Hybrid	158		11.12							
	D 3	100		11.12							
	D 3	120		11.10							
	D 5	151		11.10							
	D 5 AWD	151		11.10							
	T3	110		11.10							
	T4	132		11.10							
	T4F	132		04.11							
	T5	177		11.10							
	T 6 AWD	224		11.10				G1201009	+ 17" wheel <sup>2)</sup>	24142 20,6 +	ATE
	1.6 DRIVE	84	54071	06.11				G2128154	+ 16" wheel <sup>1)</sup>	300 28,0 26,0 V L +S +C	
	2.0 T	149	54071	11.10							
	2.4 D5	158	54071	06.11							
	2.4 D5 AWD	158	54071	06.11							
	2.4 D6 Plug-in-Hybrid	158	54071	11.12							
	D 3	100	54071	10.12							
	D 3	120	54071	11.10							
	D 5	151	54071	11.10							
	D 5 AWD	151	54071	11.10							
	T 6 AWD	224	54071	11.10							
	T3	110	54071	11.10							
	T4	132	54071	11.10							
	T4F	132	54071	04.11							
	T5	177	54071	11.10							
	1.6 DRIVE	84		06.11				G1020787	- (CEN) (USA)	24496 17,3 /Acc/S	LUC
	2.0 T	149		11.10							
	2.4 D5	158		06.11							
	2.4 D5 AWD	158		06.11							
	2.4 D6 Plug-in-Hybrid	158		11.12							
	D 3	100		10.12							
	D 3	120		11.10							
	D 5	151		11.10							
	D 5 AWD	151		11.10							
	T 6 AWD	224		11.10							
	T3	110		11.10							
	T4	132		11.10							
	T4F	132		04.11							
	T5	177		11.10							
	2.4 D5	158		06.11				G1020900		24496 17,3 /Acc/S	LUC
	2.4 D5 AWD	158		06.11							
	2.4 D6 Plug-in-Hybrid	158		11.12							

<sup>1)</sup> + ruota 16" / + roue 16" / + rueda 16" / + 16" Rad

<sup>2)</sup> + ruota 17" / + roue 17" / + rueda 17" / + 17" Rad

<sup>3)</sup> + dischi massiccio / + disques massive / + disco macizo / + massive Scheiben

<sup>4)</sup> + dischi ventilati / + disques ventilés / + disco ventilado / + belüftete Scheiben

<b>VOLVO V70 I (97-00)</b>																								
	2.0	93		01.97	03.00	G1020956													21273 19,5 +WD	ATE				
	2.0	105		01.97	03.00																			
	2.0 20V	120		01.97	03.00																			
	2.0 20V	132		01.97	03.00																			
	2.0 T	155		01.97	03.00																			
	2.3 AWD			04.97	09.98																			
	2.3 T5 AWD	176		01.97	03.00																			
	2.4	103		08.99	03.00																			
	2.4	125		01.97	03.00																			
	2.4 AWD	121		10.98	05.99																			
	2.4 Bi-Fuel	103		08.99	03.00																			
	2.4 T	142		01.97	03.00																			
	2.5	106		01.97	03.00																			
	2.5	121		06.98	03.00																			
	2.5 Bi-Fuel	106		10.98	08.99																			
	2.5 T AWD	142		01.97	03.00																			
	2.5 TDI	103		01.97	03.00																			
		2.0 T	166		01.97																03.00	G1020956		
2.0 T AWD		166		01.97	03.00																			
2.3 T		184		01.97	03.00																			
2.3 T AWD		184		04.97	03.00																			
2.3 T5		176		01.97	03.00																			
2.5 AWD		195		03.99	03.00																			
	2.0	93		01.97	12.99	G1020510															20755 15,1	ATE		
	2.0	105		01.97	12.99																			
	2.0 20V	120		01.97	12.99																			
	2.0 20V	132		01.97	12.99																			
	2.0 T	155		01.97	12.99																			
	2.0 T	166		01.97	12.99																			
	2.3 AWD			04.97	09.98																			
	2.3 T	184		01.97	12.99																			
	2.3 T5	176		01.97	12.99																			
	2.4	103		08.99	12.99																			
	2.4	125		01.97	12.99																			
	2.4 AWD	121		10.98	05.99																			
	2.4 Bi-Fuel	103		08.99	12.99																			
	2.4 T	142		01.97	12.99																			
	2.5	106		01.97	12.99																			
	2.5	121		06.98	12.99																			
	2.5 Bi-Fuel	106		10.98	08.99																			
	2.5 TDI	103		01.97	12.99																			
	2.0 T AWD	166		01.97	12.99	G1020955															21385 13,0 /S	LUC		
	2.3 T AWD	184		04.97	12.99																			
	2.3 T5 AWD	176		01.97	12.99																			
	2.5 AWD	195		03.99	12.99																			
	2.5 T AWD	142		01.97	12.99																			
	2.0	93		01.00	03.00	G1020480																23076 17,5 +	ATE	
	2.0	105		01.00	03.00																			
	2.0 20V	120		01.00	03.00																			
	2.0 20V	132		01.00	03.00																			
	2.0 T	155		01.00	03.00																			
	2.0 T	166		01.00	03.00																			
	2.0 T AWD	166		01.00	03.00																			
	2.3 T	184		01.00	03.00																			
	2.3 T AWD	184		01.00	03.00																			
	2.3 T5	176		01.00	03.00																			
	2.3 T5 AWD	176		01.00	03.00																			
	2.4	103		01.00	03.00																			
	2.4	125		01.00	03.00																			
	2.4 Bi-Fuel	103		01.00	03.00																			
	2.4 T	142		01.00	03.00																			
	2.5	106		01.00	03.00																			
	2.5	121		01.00	03.00																			
	2.5 AWD	195		01.00	03.00																			
2.5 T AWD	142		01.00	03.00																				
2.5 TDI	103		01.00	03.00																				
<b>VOLVO V70 II (00-07)</b>																								
	2.0 T	132		07.01	07.07	G1020578															- 17" wheel 1)	23073 18,8 +	ATE	
	2.3	195		10.00	09.04																			
	2.4			03.00	07.07																			
	2.4	103		03.00	07.07																			
	2.4 4X4	121		03.00	09.03																			
	2.4 Bi-Fuel	103		09.01	07.07																			
	2.4 D	93		05.05	07.07																			
	2.4 D	96		12.01	07.07																			
	2.4 D5	120		08.01	07.07																			
	2.4 D5	136		12.05	07.07																			
	2.4 D5 AWD	120		03.03	07.07																			
	2.4 D5 AWD	136		12.05	07.07																			
	2.4 T	147		03.00	07.07																			
	2.4 T AWD	147		09.01	07.07																			
	2.5 T	154		04.04	07.07																			
	2.5 T AWD	154		09.02	07.07																			
	2.5 TDI	103		03.00	07.07																			
		2.3 T5	184		03.00																			07.07
2.4 T5		191		04.04	07.07																			

1) - ruota 17" / - roue 17" / - rueda 17" / - 17" Rad



### VOLVO V70 II (00-07)

	2.0 T	132		07.01	07.07	G1020694	+ 17" wheel <sup>1)</sup>	23950 19,5 +	ATE
	2.3	195		10.00	09.04				
	2.3 T5	184		03.00	07.07				
	2.4			03.00	07.07				
	2.4	103		03.00	07.07				
	2.4 4X4	121		03.00	09.03				
	2.4 Bi-Fuel	103		09.01	07.07				
	2.4 D	93		05.05	07.07				
	2.4 D	96		12.01	07.07				
	2.4 D5	120		08.01	07.07				
	2.4 D5	136		12.05	07.07				
	2.4 D5 AWD	120		03.03	07.07				
	2.4 D5 AWD	136		12.05	07.07				
	2.4 T	147		03.00	07.07				
	2.4 T AWD	147		09.01	07.07				
	2.4 T5	191		04.04	07.07				
	2.5 T	154		04.04	07.07				
2.5 T AWD	154		09.02	07.07					
2.5 TDI	103		03.00	07.07					
	2.0 T	132		07.01	07.07	G1020480		23076 17,5 +	ATE
	2.3	195		10.00	09.04				
	2.3 T5	184		03.00	07.07				
	2.4			03.00	07.07				
	2.4	103		03.00	07.07				
	2.4 4X4	121		03.00	09.03				
	2.4 Bi-Fuel	103		09.01	07.07				
	2.4 D	93		05.05	07.07				
	2.4 D	96		12.01	07.07				
	2.4 D5	120		08.01	07.07				
	2.4 D5	136		12.05	07.07				
	2.4 D5 AWD	120		03.03	07.07				
	2.4 D5 AWD	136		12.05	07.07				
	2.4 T	147		03.00	07.07				
	2.4 T AWD	147		09.01	07.07				
	2.4 T5	191		04.04	07.07				
	2.5 T	154		04.04	07.07				
2.5 T AWD	154		09.02	07.07					
2.5 TDI	103		03.00	07.07					

### VOLVO V70 III (07-)

	1.6 DRIVE			01.10		G1020889	+ 16" wheel <sup>2)</sup>	24123 20,3 +	ATE					
	1.6 T4F	132		01.11										
	2.0	107		10.07										
	2.0 D	100		10.07										
	2.0 D3	100		05.12										
	2.0 D3	120		03.10										
	2.0 D4	120		01.13										
	2.0 FlexiFuel	107		09.07										
	2.0 T	149		01.10										
	2.4 D	120		08.07										
	2.4 D	129		10.09										
	2.4 D4 AWD	120		01.13										
	2.4 D5	136		08.07										
	2.4 D5	151		12.09										
	2.4 D5	158		06.11										
	2.4 D5 AWD	136		10.07										
	2.4 D5 AWD	151		12.09										
	2.4 D5 AWD	158		06.11										
	2.5 T	147		08.07										
	2.5 T	170		10.09										
	2.5 T FlexiFuel	147		04.08										
	2.5 T FlexiFuel	170		10.09										
	3.0 T6 AWD	210		08.07										
	3.0 T6 AWD	224		04.11										
	3.2	175		08.07										
	3.2 AWD	175		08.07										
	T4	132		10.10										
	T5	177		01.10										
		1.6 DRIVE			01.10						G1201009	+ 17"/18" wheel <sup>3)</sup>	24142 20,6 +	ATE
		1.6 T4F	132		01.11									
		2.0	107		10.07									
2.0 D		100		10.07										
2.0 D3		100		05.12										
2.0 D3		120		03.10										
2.0 D4		120		01.13										
2.0 FlexiFuel		107		09.07										
2.0 T		149		01.10										
2.4 D		120		08.07										
2.4 D		129		10.09										
2.4 D4 AWD		120		01.13										
2.4 D5		136		08.07										
2.4 D5		151		12.09										
2.4 D5		158		06.11										
2.4 D5 AWD		136		10.07										
2.4 D5 AWD		151		12.09										
2.4 D5 AWD	158		06.11											
2.5 T	147		08.07											

<sup>1)</sup> + ruota 17" / + roue 17" / + rueda 17" / + 17" Rad

<sup>2)</sup> + ruota 16" / + roue 16" / + rueda 16" / + 16" Rad

<sup>3)</sup> + ruota 17"/18" / + roue 17"/18" / + rueda 17"/18" / + 17"/18" Rad



VOLVO V70 III (07-)									
	2.5 T	170		10.09		G1201009	+ 17"/18" wheel <sup>1)</sup>	24142 20,6 +	ATE
	2.5 T FlexiFuel	147		04.08					
	2.5 T FlexiFuel	170		10.09					
	3.0 T6 AWD	210		08.07					
	3.0 T6 AWD	224		04.11					
	3.2	175		08.07					
	3.2 AWD	175		08.07					
	T4	132		10.10					
	T5	177		01.10					
	1.6 DRIVE			01.10		G2128154	+ 16" wheel <sup>2)</sup>	300 28,0 26,0 V L +S +C	
	1.6 T4F	132		01.11					
	2.0	107		10.07					
	2.0 D	100		10.07					
	2.0 D3	100		05.12					
	2.0 D3	120		03.10					
	2.0 D4	120		01.13					
	2.0 FlexiFuel	107		09.07					
	2.0 T	149		01.10					
	2.4 D	120		08.07					
	2.4 D	129		10.09					
	2.4 D4 AWD	120		01.13					
	2.4 D5	136		08.07					
	2.4 D5	151		12.09					
	2.4 D5	158		06.11					
	2.4 D5 AWD	136		10.07					
	2.4 D5 AWD	151		12.09					
	2.4 D5 AWD	158		06.11					
	2.5 T	147		08.07					
	2.5 T	170		10.09					
	2.5 T FlexiFuel	147		04.08					
	2.5 T FlexiFuel	170		10.09					
	3.0 T6 AWD	210		08.07					
	3.0 T6 AWD	224		04.11					
	3.2	175		08.07					
	3.2 AWD	175		08.07					
	T4	132		10.10					
	T5	177		01.10					
	1.6 DRIVE			01.10		G1201135	+ mechanical parking brake <sup>3)</sup>	24537 15,8 /Acc/S	LUC
	1.6 T4F	132		01.11					
	2.0	107		10.07					
	2.0 D	100		10.07					
	2.0 D3	100		05.12					
	2.0 D3	120		03.10					
	2.0 D4	120		01.13					
	2.0 FlexiFuel	107		09.07					
	2.0 T	149		01.10					
	2.4 D	120		08.07					
	2.4 D	129		10.09					
	2.4 D4 AWD	120		01.13					
	2.4 D5	136		08.07					
	2.4 D5	151		12.09					
	2.4 D5	158		06.11					
	2.4 D5 AWD	136		10.07					
	2.4 D5 AWD	151		12.09					
	2.4 D5 AWD	158		06.11					
	2.5 T	147		08.07					
	2.5 T	170		10.09					
	2.5 T FlexiFuel	147		04.08					
	2.5 T FlexiFuel	170		10.09					
	3.0 T6 AWD	210		08.07					
	3.0 T6 AWD	224		04.11					
	3.2	175		08.07					
	3.2 AWD	175		08.07					
	T4	132		10.10					
	T5	177		01.10					
	1.6 DRIVE			01.10		G1020787	+ electric parking brake <sup>5)</sup>	24496 17,3 /Acc/S	LUC
	1.6 T4F	132		01.11					
	2.0	107		10.07					
	2.0 D	100		10.07					
	2.0 D3	100		05.12					
	2.0 D3	120		03.10					
	2.0 D4	120		01.13					
	2.0 FlexiFuel	107		09.07					
	2.0 T	149		01.10					
	2.4 D	120		08.07					
	2.4 D	129		10.09					
	2.4 D4 AWD	120		01.13					
	2.4 D5	136		08.07					
	2.4 D5	151		12.09					
	2.4 D5	158		06.11					
	2.4 D5 AWD	136		10.07					
	2.4 D5 AWD	151		12.09					
	2.4 D5 AWD	158		06.11					
	2.5 T	147		08.07					
	2.5 T	170		10.09					
	2.5 T FlexiFuel	147		04.08					
	2.5 T FlexiFuel	170		10.09					
				10.09					

<sup>1)</sup> + ruota 17"/18" / + roue 17"/18" / + rueda 17"/18" / + 17"/18" Rad

<sup>2)</sup> + ruota 16" / + roue 16" / + rueda 16" / + 16" Rad

<sup>3)</sup> + fr. stazionamento meccanico / + frein à main mécanique / + freno de mano mecánica / + mechanische Feststellbremse

<sup>4)</sup> - dischi ventilati / - disques ventilés / - disco ventilado / - belüftete Scheiben

<sup>5)</sup> + freno a mano elettrico / + frein à main électrique / + freno de mano eléctrico / + elektrische Feststellbremse





VOLVO V70 III (07-)														
	3.0 T6 AWD	210		08.07		- ventilated discs <sup>1)</sup>	G1020787	+ electric parking brake <sup>2)</sup>	24496 17,3 /Acc/S	LUC				
	3.0 T6 AWD	224		04.11		- ventilated discs <sup>1)</sup>								
	3.2	175		08.07		- ventilated discs <sup>1)</sup>								
	3.2 AWD	175		08.07		- ventilated discs <sup>1)</sup>								
	T4	132		10.10		- ventilated discs <sup>1)</sup>								
	T5	177		01.10		- ventilated discs <sup>1)</sup>								
	1.6 DRIVe			01.10		+ ventilated discs <sup>3)</sup>	G1020900	+ electric parking brake <sup>2)</sup>	24496 17,3 /Acc/S	LUC				
	1.6 T4F	132		01.11		+ ventilated discs <sup>3)</sup>								
	2.0	107		10.07		+ ventilated discs <sup>3)</sup>								
	2.0 D	100		10.07		+ ventilated discs <sup>3)</sup>								
	2.0 D3	100		05.12		+ ventilated discs <sup>3)</sup>								
	2.0 D3	120		03.10		+ ventilated discs <sup>3)</sup>								
	2.0 D4	120		01.13		+ ventilated discs <sup>3)</sup>								
	2.0 FlexiFuel	107		09.07		+ ventilated discs <sup>3)</sup>								
	2.0 T	149		01.10		+ ventilated discs <sup>3)</sup>								
	2.4 D	120		08.07		+ ventilated discs <sup>3)</sup>								
	2.4 D	129		10.09		+ ventilated discs <sup>3)</sup>								
	2.4 D4 AWD	120		01.13		+ ventilated discs <sup>3)</sup>								
	2.4 D5	136		08.07		+ ventilated discs <sup>3)</sup>								
	2.4 D5	151		12.09		+ ventilated discs <sup>3)</sup>								
2.4 D5	158		06.11		+ ventilated discs <sup>3)</sup>									
2.4 D5 AWD	136		10.07		+ ventilated discs <sup>3)</sup>									
2.4 D5 AWD	151		12.09		+ ventilated discs <sup>3)</sup>									
2.4 D5 AWD	158		06.11		+ ventilated discs <sup>3)</sup>									
2.5 T	147		08.07		+ ventilated discs <sup>3)</sup>									
2.5 T	170		10.09		+ ventilated discs <sup>3)</sup>									
2.5 T FlexiFuel	147		04.08		+ ventilated discs <sup>3)</sup>									
2.5 T FlexiFuel	170		10.09		+ ventilated discs <sup>3)</sup>									
3.0 T6 AWD	210		08.07		+ ventilated discs <sup>3)</sup>									
3.0 T6 AWD	224		04.11		+ ventilated discs <sup>3)</sup>									
3.2	175		08.07		+ ventilated discs <sup>3)</sup>									
3.2 AWD	175		08.07		+ ventilated discs <sup>3)</sup>									
T4	132		10.10		+ ventilated discs <sup>3)</sup>									
T5	177		01.10		+ ventilated discs <sup>3)</sup>									
VOLVO V90 (97-98)														
	2.5	125		11.96	10.98		G1020955		21385 13,0 /S	LUC				
	2.5	132		11.96	10.97									
	2.9	132		01.97	12.98									
	2.9	150		01.97	12.98									
VOLVO XC60 (08-)														
	2.0 D3	100		04.12			G1020900		24496 17,3 /Acc/S	LUC				
	2.0 D3 DRIVe	120		03.10										
	2.0 T	149		03.10										
	2.4 D	120		07.09										
	2.4 D	129		04.09										
	2.4 D AWD	120		09.08										
	2.4 D5	158		06.11										
	2.4 D5 AWD	136		09.08										
	2.4 D5 AWD	151		04.09										
	2.4 D5 AWD	158		06.11										
	3.0 T6 AWD	210		09.08										
	3.0 T6 AWD	224		03.10										
	3.2 AWD	175		04.09										
	3.2 AWD	179		03.10										
T5	177		09.10											
VOLVO XC70 I CROSS COUNTRY (00-07)														
	2.4 AWD	121		03.00	09.03		G1020578		23073 18,8 +	ATE				
	2.4 D5 AWD	136		12.05	07.07									
	2.4 T XC AWD			11.97	09.02									
	2.5 D5 XC AWD	120		09.02	07.07									
	2.5 T XC AWD	154		09.02	07.07									
	2.4 AWD	121		03.00	09.03		G1020480		23076 17,5 +	ATE				
	2.4 D5 AWD	136		12.05	07.07									
	2.4 T XC AWD			11.97	09.02									
	2.5 D5 XC AWD	120		09.02	07.07									
	2.5 T XC AWD	154		09.02	07.07									
VOLVO XC70 II CROSS COUNTRY (07-)														
	2.0 D3	120		08.11			G1020889	+ 16" wheel <sup>4)</sup>	24123 20,3 +	ATE				
	2.0 D3 AWD	120		08.11										
	2.4 D	129		01.10										
	2.4 D AWD	120		08.07										
	2.4 D5 AWD	136		08.07										
	2.4 D5 AWD	151		12.09										
	2.4 D5 AWD	158		06.11										
	3.0 T6 AWD	210		01.08										
	3.0 T6 AWD	224		01.10										
	3.2	179		08.07										
	3.2 AWD	175		08.07										
	3.2 AWD	179		08.07										
	2.0 D3	120		08.11							G1201009	+ 17"/18" wheel <sup>5)</sup>	24142 20,6 +	ATE
	2.0 D3 AWD	120		08.11										
2.4 D	129		01.10											
2.4 D AWD	120		08.07											

<sup>1)</sup> - dischi ventilati / - disques ventilés / - disco ventilado / - belüftete Scheiben  
<sup>2)</sup> - freno a mano elettrico / + frein à main électrique / + freno de mano eléctrico / + elektrische Feststellbremse  
<sup>3)</sup> - dischi ventilati / + disques ventilés / + disco ventilado / + belüftete Scheiben  
<sup>4)</sup> + ruota 16" / + roue 16" / + rueda 16" / + 16" Rad  
<sup>5)</sup> + ruota 17"/18" / + roue 17"/18" / + rueda 17"/18" / + 17"/18" Rad



**VOLVO XC70 II CROSS COUNTRY (07-)**

	2.4 D5 AWD	136		08.07		<b>G1201009</b>	+ 17"/18" wheel <sup>1)</sup>	<b>24142</b> 20,6 +	<b>ATE</b>
	2.4 D5 AWD	151		12.09					
	2.4 D5 AWD	158		06.11					
	3.0 T6 AWD	210		01.08					
	3.0 T6 AWD	224		01.10					
	3.2	179		08.07					
	3.2 AWD	175		08.07					
	3.2 AWD	179		08.07					
	2.0 D3	120		08.11		<b>G2128154</b>	+ 16" wheel <sup>2)</sup>	300 28,0 26,0 V L +S +C	
	2.0 D3 AWD	120		08.11					
	2.4 D	129		01.10					
	2.4 D AWD	120		08.07					
	2.4 D5 AWD	136		08.07					
	2.4 D5 AWD	151		12.09					
	2.4 D5 AWD	158		06.11					
	3.0 T6 AWD	210		01.08					
	3.0 T6 AWD	224		01.10					
	3.2	179		08.07					
	3.2 AWD	175		08.07					
	3.2 AWD	179		08.07					
	2.0 D3	120		08.11		<b>G1201135</b>	+ mechanical parking brake <sup>3)</sup>	<b>24537</b> 15,8 /Acc/S	<b>LUC</b>
	2.0 D3 AWD	120		08.11					
	2.4 D	129		01.10					
	2.4 D AWD	120		08.07					
	2.4 D5 AWD	136		08.07					
	2.4 D5 AWD	151		12.09					
	2.4 D5 AWD	158		06.11					
	3.0 T6 AWD	210		01.08					
	3.0 T6 AWD	224		01.10					
	3.2	179		08.07					
	3.2 AWD	175		08.07					
	3.2 AWD	179		08.07					
	2.0 D3	120		08.11	+ ventilated discs <sup>4)</sup>	<b>G1020900</b>	+ electric parking brake <sup>5)</sup>	<b>24496</b> 17,3 /Acc/S	<b>LUC</b>
	2.0 D3 AWD	120		08.11	+ ventilated discs <sup>4)</sup>				
	2.4 D	129		01.10	+ ventilated discs <sup>4)</sup>				
	2.4 D AWD	120		08.07	+ ventilated discs <sup>4)</sup>				
	2.4 D5 AWD	136		08.07	+ ventilated discs <sup>4)</sup>				
	2.4 D5 AWD	151		12.09	+ ventilated discs <sup>4)</sup>				
	2.4 D5 AWD	158		06.11	+ ventilated discs <sup>4)</sup>				
	3.0 T6 AWD	210		01.08	+ ventilated discs <sup>4)</sup>				
	3.0 T6 AWD	224		01.10	+ ventilated discs <sup>4)</sup>				
	3.2	179		08.07	+ ventilated discs <sup>4)</sup>				
	3.2 AWD	175		08.07	+ ventilated discs <sup>4)</sup>				
	3.2 AWD	179		08.07	+ ventilated discs <sup>4)</sup>				
	2.0 D3	120		08.11	+ solid discs <sup>6)</sup>	<b>G1020787</b>	+ electric parking brake <sup>5)</sup>	<b>24496</b> 17,3 /Acc/S	<b>LUC</b>
	2.0 D3 AWD	120		08.11	+ solid discs <sup>6)</sup>				
	2.4 D	129		01.10	+ solid discs <sup>6)</sup>				
	2.4 D AWD	120		08.07	+ solid discs <sup>6)</sup>				
	2.4 D5 AWD	136		08.07	+ solid discs <sup>6)</sup>				
	2.4 D5 AWD	151		12.09	+ solid discs <sup>6)</sup>				
	2.4 D5 AWD	158		06.11	+ solid discs <sup>6)</sup>				
	3.0 T6 AWD	210		01.08	+ solid discs <sup>6)</sup>				
	3.0 T6 AWD	224		01.10	+ solid discs <sup>6)</sup>				
	3.2	179		08.07	+ solid discs <sup>6)</sup>				
	3.2 AWD	175		08.07	+ solid discs <sup>6)</sup>				
	3.2 AWD	179		08.07	+ solid discs <sup>6)</sup>				

**VOLVO XC90 (02-)**

	2.4 D3	120		04.10		<b>G1020694</b> <b>G1020696</b>	+ 16" wheel <sup>2)</sup> - 16" wheel <sup>7)</sup>	<b>23950</b> 19,5 + <b>24141</b> 19,1 +	<b>ATE</b> <b>ATE</b>
	2.4 D5	120		04.09					
	2.4 D5	136		05.06					
	2.4 D5 AWD	120		10.02					
	2.4 D5 AWD	147		01.11					
	2.5 T	154		10.02					
	3.0 T6	200		10.02					
	3.2	175		05.06					
	3.2	179		04.10					
	4.0 V8	232		01.05					

<sup>1)</sup> + ruota 17"/18" / + roue 17"/18" / + rueda 17"/18" / + 17"/18" Rad

<sup>2)</sup> + ruota 16" / + roue 16" / + rueda 16" / + 16" Rad

<sup>3)</sup> + fr. stazionamento meccanico / + frein à main mécanique / + freno de mano mecánica / + mechanische Feststellbremse

<sup>4)</sup> + dischi ventilati / + disques ventilés / + disco ventilado / + belüftete Scheiben

<sup>5)</sup> + freno a mano elettrico / + frein à main électrique / + freno de mano eléctrico / + elektrische Feststellbremse

<sup>6)</sup> + dischi massiccio / + disques massive / + disco macizo / + massive Scheiben

<sup>7)</sup> - ruota 16" / - roue 16" / - rueda 16" / - 16" Rad

# REPLACED PARTS

Références remplacées / Codici sostitutivi / Artigos substituídos



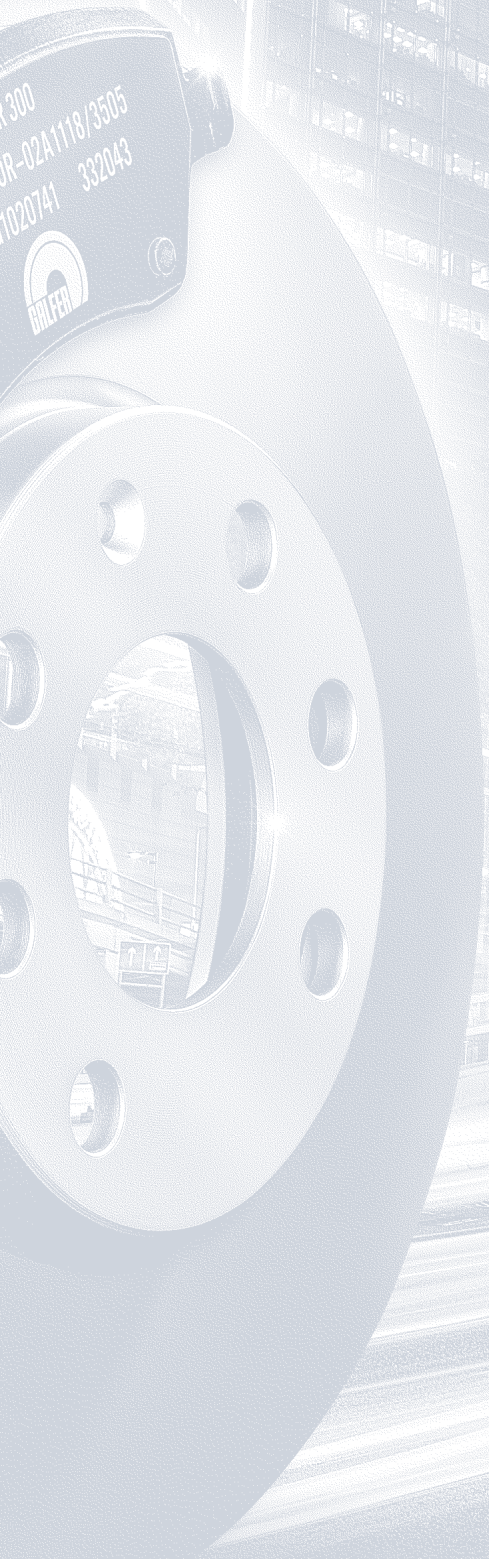

Artykuły zastąpione / Nahrazené výrobky



# Replaced parts

Références remplacées / Codici sostitutivi / Artigos substituídos /

Artykuły zastąpione / Nahrazené výrobky





 <b>Replaced No.</b> Ancienne référence / Codice precedente / Número anterior / Poprzedni numer / Předchozí číslo	 <b>Replacing No.</b> Nouvelle référence / Codice nuovo / Número posterior / Następca numer / Nástupce číslo	 <b>Replaced No.</b> Ancienne référence / Codice precedente / Número anterior / Poprzedni numer / Předchozí číslo	 <b>Replacing No.</b> Nouvelle référence / Codice nuovo / Número posterior / Następca numer / Nástupce číslo
20009396	<b>B1.G102-0009.2 G1020009</b>	20320396	<b>B1.G102-0320.2 G1020320</b>
20010396	<b>B1.G102-0010.2 G1020010</b>	20323696	<b>B1.G102-0323.2 G1020323</b>
20015396	<b>B1.G102-0015.2 G1020015</b>	20326396	<b>B1.G102-0326.2 G1020326</b>
20022596	<b>B1.G102-0022.2 G1020022</b>	20327696	<b>B1.G102-0327.2 G1020327</b>
20025396	<b>B1.G102-0025.2 G1020025</b>	20328696	<b>B1.G102-0328.2 G1020328</b>
20026396	<b>B1.G102-0026.2 G1020026</b>	20329696	<b>B1.G102-0329.2 G1020329</b>
20028396	<b>B1.G102-0028.2 G1020028</b>	20331696	<b>B1.G102-0331.2 G1020331</b>
20044696	<b>B1.G102-0044.2 G1020044</b>	20332396	<b>B1.G102-0332.2 G1020332</b>
20046596	<b>B1.G102-0046.2 G1020046</b>	20334396	<b>B1.G102-0334.2 G1020334</b>
20065596	<b>B1.G102-0065.2 G1020065</b>	20337696	<b>B1.G102-0337.2 G1020337</b>
20097396	<b>B1.G102-0097.2 G1020097</b>	20339396	<b>B1.G102-0339.2 G1020339</b>
20140696	<b>B1.G102-0140.2 G1020140</b>	20340696	<b>B1.G102-0340.2 G1020340</b>
20141696	<b>B1.G102-0141.2 G1020141</b>	20342696	<b>B1.G102-0342.2 G1020342</b>
20147696	<b>B1.G102-0147.2 G1020147</b>	20344696	<b>B1.G102-0344.2 G1020344</b>
20184696	<b>B1.G102-0184.2 G1020184</b>	20345396	<b>B1.G102-0345.2 G1020345</b>
20196696	<b>B1.G102-0196.2 G1020196</b>	20347696	<b>B1.G102-0347.2 G1020347</b>
20197696	<b>B1.G102-0197.2 G1020197</b>	20350696	<b>B1.G102-0350.2 G1020350</b>
20201396	<b>B1.G102-0201.2 G1020201</b>	20351696	<b>B1.G102-0351.2 G1020351</b>
20213696	<b>B1.G102-0213.2 G1020213</b>	20355696	<b>B1.G102-0355.2 G1020355</b>
20214396	<b>B1.G102-0214.2 G1020214</b>	20357696	<b>B1.G102-0357.2 G1020357</b>
20215696	<b>B1.G102-0215.2 G1020215</b>	20359696	<b>B1.G102-0359.2 G1020359</b>
20216696	<b>B1.G102-0216.2 G1020216</b>	20360696	<b>B1.G102-0360.2 G1020360</b>
20219696	<b>B1.G102-0219.2 G1020219</b>	20362696	<b>B1.G102-0362.2 G1020362</b>
20236696	<b>B1.G102-0236.2 G1020236</b>	20363696	<b>B1.G102-0363.2 G1020363</b>
20246696	<b>B1.G102-0246.2 G1020246</b>	20367696	<b>B1.G102-0367.2 G1020367</b>
20257396	<b>B1.G102-0257.2 G1020257</b>	20368696	<b>B1.G102-0368.2 G1020368</b>
20258396	<b>B1.G102-0258.2 G1020258</b>	20369696	<b>B1.G102-0369.2 G1020369</b>
20259696	<b>B1.G102-0259.2 G1020259</b>	20372696	<b>B1.G102-0372.2 G1020372</b>
20265396	<b>B1.G102-0265.2 G1020265</b>	20373696	<b>B1.G102-0373.2 G1020373</b>
20269796	<b>B1.G102-0269.2 G1020269</b>	20379396	<b>B1.G102-0379.2 G1020379</b>
20271596	<b>B1.G102-0271.2 G1020271</b>	20384696	<b>B1.G102-0384.2 G1020384</b>
20272396	<b>B1.G102-0272.2 G1020272</b>	20389696	<b>B1.G102-0389.2 G1020389</b>
20273696	<b>B1.G102-0273.2 G1020273</b>	20390696	<b>B1.G102-0390.2 G1020390</b>
20274396	<b>B1.G102-0274.2 G1020274</b>	20392696	<b>B1.G102-0392.2 G1020392</b>
20275796	<b>B1.G102-0275.2 G1020275</b>	20395696	<b>B1.G102-0395.2 G1020395</b>
20290796	<b>B1.G102-0290.2 G1020290</b>	20396696	<b>B1.G102-0396.2 G1020396</b>
20291696	<b>B1.G102-0291.2 G1020291</b>	20397696	<b>B1.G102-0397.2 G1020397</b>
20292696	<b>B1.G102-0292.2 G1020292</b>	20398696	<b>B1.G102-0398.2 G1020398</b>
20293396	<b>B1.G102-0293.2 G1020293</b>	20400696	<b>B1.G102-0400.2 G1020400</b>
20295696	<b>B1.G102-0295.2 G1020295</b>	20401696	<b>B1.G102-0401.2 G1020401</b>
20296396	<b>B1.G102-0296.2 G1020296</b>	20403696	<b>B1.G102-0403.2 G1020403</b>
20298696	<b>B1.G102-0298.2 G1020298</b>	20408696	<b>B1.G102-0408.2 G1020408</b>
20299696	<b>B1.G102-0299.2 G1020299</b>	20409696	<b>B1.G102-0409.2 G1020409</b>
20301696	<b>B1.G102-0301.2 G1020301</b>	20411696	<b>B1.G102-0411.2 G1020411</b>
20302696	<b>B1.G102-0302.2 G1020302</b>	20415696	<b>B1.G102-0415.2 G1020415</b>
20304396	<b>B1.G102-0304.2 G1020304</b>	20419696	<b>B1.G102-0419.2 G1020419</b>
20305696	<b>B1.G102-0305.2 G1020305</b>	20421696	<b>B1.G102-0421.2 G1020421</b>
20308696	<b>B1.G102-0308.2 G1020308</b>	20422396	<b>B1.G102-0422.2 G1020422</b>
20310696	<b>B1.G102-0310.2 G1020310</b>	20423396	<b>B1.G102-0423.2 G1020423</b>
20311396	<b>B1.G102-0311.2 G1020311</b>	20427696	<b>B1.G102-0427.2 G1020427</b>
20312696	<b>B1.G102-0312.2 G1020312</b>	20440696	<b>B1.G102-0440.2 G1020440</b>
20313696	<b>B1.G102-0313.2 G1020313</b>	20441696	<b>B1.G102-0441.2 G1020441</b>
20315396	<b>B1.G102-0315.2 G1020315</b>	20442696	<b>B1.G102-0442.2 G1020442</b>
20316696	<b>B1.G102-0316.2 G1020316</b>	20443696	<b>B1.G102-0443.2 G1020443</b>
20317396	<b>B1.G102-0317.2 G1020317</b>	20444696	<b>B1.G102-0444.2 G1020444</b>



# Replaced parts

Références remplacées / Codici sostitutivi / Artigos substituídos /





Artykuły zastąpione / Nahrazené výrobky

 <b>Replaced No.</b> Ancienne référence / Codice precedente / Número anterior / Poprzedni numer / Předchozí číslo	 <b>Replacing No.</b> Nouvelle référence / Codice nuovo / Número posterior / Następca numer / Nástupce číslo	 <b>Replaced No.</b> Ancienne référence / Codice precedente / Número anterior / Poprzedni numer / Předchozí číslo	 <b>Replacing No.</b> Nouvelle référence / Codice nuovo / Número posterior / Następca numer / Nástupce číslo
20448696	<b>B1.G102-0448.2 G1020448</b>	20559696	<b>B1.G102-0559.2 G1020559</b>
20451696	<b>B1.G102-0451.2 G1020451</b>	20560696	<b>B1.G102-0560.2 G1020560</b>
20457696	<b>B1.G102-0457.2 G1020457</b>	20562696	<b>B1.G102-0562.2 G1020562</b>
20458696	<b>B1.G102-0458.2 G1020458</b>	20563696	<b>B1.G102-0563.2 G1020563</b>
20459696	<b>B1.G102-0459.2 G1020459</b>	20564696	<b>B1.G102-0564.2 G1020564</b>
20463696	<b>B1.G102-0463.2 G1020463</b>	20566696	<b>B1.G102-0566.2 G1020566</b>
20467596	<b>B1.G102-0467.2 G1020467</b>	20567696	<b>B1.G102-0567.2 G1020567</b>
20469696	<b>B1.G102-0469.2 G1020469</b>	20568696	<b>B1.G102-0568.2 G1020568</b>
20470696	<b>B1.G102-0470.2 G1020470</b>	20569696	<b>B1.G102-0569.2 G1020569</b>
20473696	<b>B1.G102-0473.2 G1020473</b>	20570696	<b>B1.G102-0570.2 G1020570</b>
20474396	<b>B1.G102-0474.2 G1020474</b>	20572696	<b>B1.G102-0572.2 G1020572</b>
20478696	<b>B1.G102-0478.2 G1020478</b>	20573696	<b>B1.G102-0573.2 G1020573</b>
20480696	<b>B1.G102-0480.2 G1020480</b>	20574696	<b>B1.G102-0574.2 G1020574</b>
20482696	<b>B1.G102-0482.2 G1020482</b>	20575696	<b>B1.G102-0575.2 G1020575</b>
20483696	<b>B1.G102-0483.2 G1020483</b>	20576696	<b>B1.G102-0576.2 G1020576</b>
20484696	<b>B1.G102-0484.2 G1020484</b>	20578696	<b>B1.G102-0578.2 G1020578</b>
20487696	<b>B1.G102-0487.2 G1020487</b>	20580696	<b>B1.G102-0580.2 G1020580</b>
20489696	<b>B1.G102-0489.2 G1020489</b>	20582696	<b>B1.G102-0582.2 G1020582</b>
20492696	<b>B1.G102-0492.2 G1020492</b>	20583696	<b>B1.G102-0583.2 G1020583</b>
20496696	<b>B1.G102-0496.2 G1020496</b>	20584696	<b>B1.G102-0584.2 G1020584</b>
20497696	<b>B1.G102-0497.2 G1020497</b>	20586696	<b>B1.G102-0586.2 G1020586</b>
20500696	<b>B1.G102-0500.2 G1020500</b>	20588696	<b>B1.G102-0588.2 G1020588</b>
20501696	<b>B1.G102-0501.2 G1020501</b>	20591696	<b>B1.G102-0591.2 G1020591</b>
20503696	<b>B1.G102-0503.2 G1020503</b>	20593696	<b>B1.G102-0593.2 G1020593</b>
20504696	<b>B1.G102-0504.2 G1020504</b>	20595696	<b>B1.G102-0595.2 G1020595</b>
20505696	<b>B1.G102-0505.2 G1020505</b>	20597696	<b>B1.G102-0597.2 G1020597</b>
20507696	<b>B1.G102-0507.2 G1020507</b>	20602696	<b>B1.G102-0602.2 G1020602</b>
20510696	<b>B1.G102-0510.2 G1020510</b>	20603696	<b>B1.G102-0603.2 G1020603</b>
20511696	<b>B1.G102-0511.2 G1020511</b>	20604696	<b>B1.G102-0604.2 G1020604</b>
20512696	<b>B1.G102-0512.2 G1020512</b>	20605696	<b>B1.G102-0605.2 G1020605</b>
20513696	<b>B1.G102-0513.2 G1020513</b>	20608696	<b>B1.G102-0608.2 G1020608</b>
20514696	<b>B1.G102-0514.2 G1020514</b>	20610696	<b>B1.G102-0610.2 G1020610</b>
20515696	<b>B1.G102-0515.2 G1020515</b>	20613696	<b>B1.G102-0613.2 G1020613</b>
20516696	<b>B1.G102-0516.2 G1020516</b>	20614696	<b>B1.G102-0614.2 G1020614</b>
20517696	<b>B1.G102-0517.2 G1020517</b>	20615696	<b>B1.G102-0615.2 G1020615</b>
20518696	<b>B1.G102-0518.2 G1020518</b>	20617396	<b>B1.G102-0617.2 G1020617</b>
20519696	<b>B1.G102-0519.2 G1020519</b>	20618396	<b>B1.G102-0618.2 G1020618</b>
20522696	<b>B1.G102-0522.2 G1020522</b>	20621696	<b>B1.G102-0621.2 G1020621</b>
20524696	<b>B1.G102-0524.2 G1020524</b>	20622696	<b>B1.G102-0622.2 G1020622</b>
20527696	<b>B1.G102-0527.2 G1020527</b>	20624696	<b>B1.G102-0624.2 G1020624</b>
20529696	<b>B1.G102-0529.2 G1020529</b>	20625696	<b>B1.G102-0625.2 G1020625</b>
20533396	<b>B1.G102-0533.2 G1020533</b>	20627696	<b>B1.G102-0627.2 G1020627</b>
20534696	<b>B1.G102-0534.2 G1020534</b>	20630696	<b>B1.G102-0630.2 G1020630</b>
20537696	<b>B1.G102-0537.2 G1020537</b>	20632696	<b>B1.G102-0632.2 G1020632</b>
20538696	<b>B1.G102-0538.2 G1020538</b>	20633696	<b>B1.G102-0633.2 G1020633</b>
20540696	<b>B1.G102-0540.2 G1020540</b>	20634696	<b>B1.G102-0634.2 G1020634</b>
20542696	<b>B1.G102-0542.2 G1020542</b>	20637696	<b>B1.G102-0637.2 G1020637</b>
20544696	<b>B1.G102-0544.2 G1020544</b>	20638696	<b>B1.G102-0638.2 G1020638</b>
20545696	<b>B1.G102-0545.2 G1020545</b>	20642696	<b>B1.G102-0642.2 G1020642</b>
20547696	<b>B1.G102-0547.2 G1020547</b>	20644696	<b>B1.G102-0644.2 G1020644</b>
20548696	<b>B1.G102-0548.2 G1020548</b>	20646696	<b>B1.G102-0646.2 G1020646</b>
20549696	<b>B1.G102-0549.2 G1020549</b>	20648696	<b>B1.G102-0648.2 G1020648</b>
20550696	<b>B1.G102-0550.2 G1020550</b>	20650696	<b>B1.G102-0650.2 G1020650</b>
20554696	<b>B1.G102-0554.2 G1020554</b>	20652696	<b>B1.G102-0652.2 G1020652</b>
20557696	<b>B1.G102-0557.2 G1020557</b>	20654696	<b>B1.G102-0654.2 G1020654</b>

# Replaced parts

Références remplacées / Codici sostitutivi / Artigos substituídos /





Artykuły zastąpione / Nahrazené výrobky

 <b>Replaced No.</b> Ancienne référence / Codice precedente / Número anterior / Poprzedni numer / Předchozí číslo	 <b>Replacing No.</b> Nouvelle référence / Codice nuovo / Número posterior / Następcza numer / Nástupce číslo	 <b>Replaced No.</b> Ancienne référence / Codice precedente / Número anterior / Poprzedni numer / Předchozí číslo	 <b>Replacing No.</b> Nouvelle référence / Codice nuovo / Número posterior / Następcza numer / Nástupce číslo
20658696	<b>B1.G102-0658.2 G1020658</b>	20756696	<b>B1.G102-0756.2 G1020756</b>
20659696	<b>B1.G102-0659.2 G1020659</b>	20758696	<b>B1.G102-0758.2 G1020758</b>
20660696	<b>B1.G102-0660.2 G1020660</b>	20759696	<b>B1.G102-0759.2 G1020759</b>
20661696	<b>B1.G102-0661.2 G1020661</b>	20761696	<b>B1.G102-0761.2 G1020761</b>
20662696	<b>B1.G102-0662.2 G1020662</b>	20762696	<b>B1.G102-0762.2 G1020762</b>
20663696	<b>B1.G102-0663.2 G1020663</b>	20763696	<b>B1.G102-0763.2 G1020763</b>
20666696	<b>B1.G102-0666.2 G1020666</b>	20764696	<b>B1.G102-0764.2 G1020764</b>
20670696	<b>B1.G102-0670.2 G1020670</b>	20765696	<b>B1.G102-0765.2 G1020765</b>
20672696	<b>B1.G102-0672.2 G1020672</b>	20766696	<b>B1.G102-0766.2 G1020766</b>
20676696	<b>B1.G102-0676.2 G1020676</b>	20768696	<b>B1.G102-0768.2 G1020768</b>
20677696	<b>B1.G102-0677.2 G1020677</b>	20769696	<b>B1.G102-0769.2 G1020769</b>
20678696	<b>B1.G102-0678.2 G1020678</b>	20770696	<b>B1.G102-0770.2 G1020770</b>
20680696	<b>B1.G102-0680.2 G1020680</b>	20772696	<b>B1.G102-0772.2 G1020772</b>
20682696	<b>B1.G102-0682.2 G1020682</b>	20774696	<b>B1.G102-0774.2 G1020774</b>
20683696	<b>B1.G102-0683.2 G1020683</b>	20776696	<b>B1.G102-0776.2 G1020776</b>
20685696	<b>B1.G102-0685.2 G1020685</b>	20777696	<b>B1.G102-0777.2 G1020777</b>
20686696	<b>B1.G102-0686.2 G1020686</b>	20779696	<b>B1.G102-0779.2 G1020779</b>
20687696	<b>B1.G102-0687.2 G1020687</b>	20780696	<b>B1.G102-0780.2 G1020780</b>
20691696	<b>B1.G102-0691.2 G1020691</b>	20785696	<b>B1.G102-0785.2 G1020785</b>
20692696	<b>B1.G102-0692.2 G1020692</b>	20786696	<b>B1.G102-0786.2 G1020786</b>
20694696	<b>B1.G102-0694.2 G1020694</b>	20787696	<b>B1.G102-0787.2 G1020787</b>
20696696	<b>B1.G102-0696.2 G1020696</b>	20790696	<b>B1.G102-0790.2 G1020790</b>
20698696	<b>B1.G102-0698.2 G1020698</b>	20792696	<b>B1.G102-0792.2 G1020792</b>
20699696	<b>B1.G102-0699.2 G1020699</b>	20794696	<b>B1.G102-0794.2 G1020794</b>
20701696	<b>B1.G102-0701.2 G1020701</b>	20796696	<b>B1.G102-0796.2 G1020796</b>
20704696	<b>B1.G102-0704.2 G1020704</b>	20798696	<b>B1.G102-0798.2 G1020798</b>
20706696	<b>B1.G102-0706.2 G1020706</b>	20799696	<b>B1.G102-0799.2 G1020799</b>
20707696	<b>B1.G102-0707.2 G1020707</b>	20800796	<b>B1.G102-0800.2 G1020800</b>
20709696	<b>B1.G102-0709.2 G1020709</b>	20801796	<b>B1.G102-0801.2 G1020801</b>
20710696	<b>B1.G102-0710.2 G1020710</b>	20802796	<b>B1.G102-0802.2 G1020802</b>
20711696	<b>B1.G102-0711.2 G1020711</b>	20803696	<b>B1.G102-0803.2 G1020803</b>
20712696	<b>B1.G102-0712.2 G1020712</b>	20806696	<b>B1.G102-0806.2 G1020806</b>
20713696	<b>B1.G102-0713.2 G1020713</b>	20812696	<b>B1.G102-0812.2 G1020812</b>
20714696	<b>B1.G102-0714.2 G1020714</b>	20817696	<b>B1.G102-0817.2 G1020817</b>
20719696	<b>B1.G102-0719.2 G1020719</b>	20819696	<b>B1.G102-0819.2 G1020819</b>
20721696	<b>B1.G102-0721.2 G1020721</b>	20823696	<b>B1.G102-0823.2 G1020823</b>
20722696	<b>B1.G102-0722.2 G1020722</b>	20825696	<b>B1.G102-0825.2 G1020825</b>
20727696	<b>B1.G102-0727.2 G1020727</b>	20828696	<b>B1.G102-0828.2 G1020828</b>
20730696	<b>B1.G102-0730.2 G1020730</b>	20829696	<b>B1.G102-0829.2 G1020829</b>
20732696	<b>B1.G102-0732.2 G1020732</b>	20830696	<b>B1.G102-0830.2 G1020830</b>
20733696	<b>B1.G102-0733.2 G1020733</b>	20833696	<b>B1.G102-0833.2 G1020833</b>
20734696	<b>B1.G102-0734.2 G1020734</b>	20834696	<b>B1.G102-0834.2 G1020834</b>
20735696	<b>B1.G102-0735.2 G1020735</b>	20836696	<b>B1.G102-0836.2 G1020836</b>
20737696	<b>B1.G102-0737.2 G1020737</b>	20844696	<b>B1.G102-0844.2 G1020844</b>
20738696	<b>B1.G102-0738.2 G1020738</b>	20846696	<b>B1.G102-0846.2 G1020846</b>
20740696	<b>B1.G102-0740.2 G1020740</b>	20848696	<b>B1.G102-0848.2 G1020848</b>
20741696	<b>B1.G102-0741.2 G1020741</b>	20850696	<b>B1.G102-0850.2 G1020850</b>
20742696	<b>B1.G102-0742.2 G1020742</b>	20852696	<b>B1.G102-0852.2 G1020852</b>
20745696	<b>B1.G102-0745.2 G1020745</b>	20855696	<b>B1.G102-0855.2 G1020855</b>
20746696	<b>B1.G102-0746.2 G1020746</b>	20856696	<b>B1.G102-0856.2 G1020856</b>
20751696	<b>B1.G102-0751.2 G1020751</b>	20858696	<b>B1.G102-0858.2 G1020858</b>
20752696	<b>B1.G102-0752.2 G1020752</b>	20859696	<b>B1.G102-0859.2 G1020859</b>
20753696	<b>B1.G102-0753.2 G1020753</b>	20860696	<b>B1.G102-0860.2 G1020860</b>
20754696	<b>B1.G102-0754.2 G1020754</b>	20862696	<b>B1.G102-0862.2 G1020862</b>
20755696	<b>B1.G102-0755.2 G1020755</b>	20866696	<b>B1.G102-0866.2 G1020866</b>

# Replaced parts

Références remplacées / Codici sostitutivi / Artigos substituídos /

Artykuły zastąpione / Nahrazené výrobky

 <b>Replaced No.</b> Ancienne référence / Codice precedente / Número anterior / Poprzedni numer / Předchozí číslo	 <b>Replacing No.</b> Nouvelle référence / Codice nuovo / Número posterior / Następcza numer / Nástupce číslo	 <b>Replaced No.</b> Ancienne référence / Codice precedente / Número anterior / Poprzedni numer / Předchozí číslo	 <b>Replacing No.</b> Nouvelle référence / Codice nuovo / Número posterior / Następcza numer / Nástupce číslo
20867696	<b>B1.G102-0867.2 G1020867</b>	20999696	<b>B1.G102-0999.2 G1020999</b>
20871696	<b>B1.G102-0871.2 G1020871</b>	201000696	<b>B1.G120-1000.2 G1201000</b>
20872696	<b>B1.G102-0872.2 G1020872</b>	201002696	<b>B1.G120-1002.2 G1201002</b>
20873696	<b>B1.G102-0873.2 G1020873</b>	201004696	<b>B1.G120-1004.2 G1201004</b>
20874696	<b>B1.G102-0874.2 G1020874</b>	201005696	<b>B1.G120-1005.2 G1201005</b>
20875696	<b>B1.G102-0875.2 G1020875</b>	201009696	<b>B1.G120-1009.2 G1201009</b>
20876696	<b>B1.G102-0876.2 G1020876</b>	201010696	<b>B1.G120-1010.2 G1201010</b>
20877696	<b>B1.G102-0877.2 G1020877</b>	201011696	<b>B1.G120-1011.2 G1201011</b>
20882696	<b>B1.G102-0882.2 G1020882</b>	201013696	<b>B1.G120-1013.2 G1201013</b>
20883696	<b>B1.G102-0883.2 G1020883</b>	201014696	<b>B1.G120-1014.2 G1201014</b>
20885396	<b>B1.G102-0885.2 G1020885</b>	201022696	<b>B1.G120-1022.2 G1201022</b>
20886396	<b>B1.G102-0886.2 G1020886</b>	201025696	<b>B1.G120-1025.2 G1201025</b>
20887696	<b>B1.G102-0887.2 G1020887</b>	201029696	<b>B1.G120-1029.2 G1201029</b>
20889696	<b>B1.G102-0889.2 G1020889</b>	201033696	<b>B1.G120-1033.2 G1201033</b>
20891796	<b>B1.G102-0891.2 G1020891</b>	201035696	<b>B1.G120-1035.2 G1201035</b>
20893696	<b>B1.G102-0893.2 G1020893</b>	201047696	<b>B1.G120-1047.2 G1201047</b>
20895696	<b>B1.G102-0895.2 G1020895</b>	201053696	<b>B1.G120-1053.2 G1201053</b>
20896696	<b>B1.G102-0896.2 G1020896</b>	201056696	<b>B1.G120-1056.2 G1201056</b>
20900696	<b>B1.G102-0900.2 G1020900</b>	201059696	<b>B1.G120-1059.2 G1201059</b>
20901696	<b>B1.G102-0901.2 G1020901</b>	201065696	<b>B1.G120-1065.2 G1201065</b>
20905696	<b>B1.G102-0905.2 G1020905</b>	201066696	<b>B1.G120-1066.2 G1201066</b>
20907696	<b>B1.G102-0907.2 G1020907</b>	201069696	<b>B1.G120-1069.2 G1201069</b>
20920696	<b>B1.G102-0920.2 G1020920</b>	201070696	<b>B1.G120-1070.2 G1201070</b>
20921696	<b>B1.G102-0921.2 G1020921</b>	201073696	<b>B1.G120-1073.2 G1201073</b>
20922696	<b>B1.G102-0922.2 G1020922</b>	201079696	<b>B1.G120-1079.2 G1201079</b>
20924696	<b>B1.G102-0924.2 G1020924</b>	201085696	<b>B1.G120-1085.2 G1201085</b>
20925696	<b>B1.G102-0925.2 G1020925</b>	201126696	<b>B1.G120-1126.2 G1201126</b>
20928696	<b>B1.G102-0928.2 G1020928</b>	201128696	<b>B1.G120-1128.2 G1201128</b>
20933696	<b>B1.G102-0933.2 G1020933</b>	201135696	<b>B1.G120-1135.2 G1201135</b>
20934696	<b>B1.G102-0934.2 G1020934</b>	201143696	<b>B1.G120-1143.2 G1201143</b>
20935696	<b>B1.G102-0935.2 G1020935</b>	201145696	<b>B1.G120-1145.2 G1201145</b>
20937696	<b>B1.G102-0937.2 G1020937</b>	201147696	<b>B1.G120-1147.2 G1201147</b>
20938696	<b>B1.G102-0938.2 G1020938</b>	201148696	<b>B1.G120-1148.2 G1201148</b>
20939696	<b>B1.G102-0939.2 G1020939</b>	201149696	<b>B1.G120-1149.2 G1201149</b>
20940696	<b>B1.G102-0940.2 G1020940</b>	201209696	<b>B1.G120-1209.2 G1201209</b>
20946696	<b>B1.G102-0946.2 G1020946</b>	201213696	<b>B1.G120-1213.2 G1201213</b>
20951696	<b>B1.G102-0951.2 G1020951</b>	201224696	<b>B1.G120-1224.2 G1201224</b>
20952696	<b>B1.G102-0952.2 G1020952</b>	201225696	<b>B1.G120-1225.2 G1201225</b>
20953696	<b>B1.G102-0953.2 G1020953</b>	201272696	<b>B1.G120-1272.2 G1201272</b>
20955696	<b>B1.G102-0955.2 G1020955</b>	205203696	<b>B1.G120-5203.2 G1205203</b>
20956696	<b>B1.G102-0956.2 G1020956</b>	205215696	<b>B1.G120-5215.2 G1205215</b>
20963696	<b>B1.G102-0963.2 G1020963</b>	205230696	<b>B1.G120-5230.2 G1205230</b>
20971696	<b>B1.G102-0971.2 G1020971</b>	205234696	<b>B1.G120-5234.2 G1205234</b>
20974696	<b>B1.G102-0974.2 G1020974</b>	205238696	<b>B1.G120-5238.2 G1205238</b>
20975696	<b>B1.G102-0975.2 G1020975</b>	205241696	<b>B1.G120-5241.2 G1205241</b>
20979696	<b>B1.G102-0979.2 G1020979</b>	205242696	<b>B1.G120-5242.2 G1205242</b>
20981696	<b>B1.G102-0981.2 G1020981</b>	205333696	<b>B1.G120-5333.2 G1205333</b>
20983696	<b>B1.G102-0983.2 G1020983</b>	205344696	<b>B1.G120-5344.2 G1205344</b>
20985696	<b>B1.G102-0985.2 G1020985</b>	205352696	<b>B1.G120-5352.2 G1205352</b>
20987696	<b>B1.G102-0987.2 G1020987</b>	205366696	<b>B1.G120-5366.2 G1205366</b>
20988696	<b>B1.G102-0988.2 G1020988</b>	205404696	<b>B1.G120-5404.2 G1205404</b>
20992696	<b>B1.G102-0992.2 G1020992</b>	205418696	<b>B1.G120-5418.2 G1205418</b>
20993696	<b>B1.G102-0993.2 G1020993</b>		
20994696	<b>B1.G102-0994.2 G1020994</b>		
20995696	<b>B1.G102-0995.2 G1020995</b>		

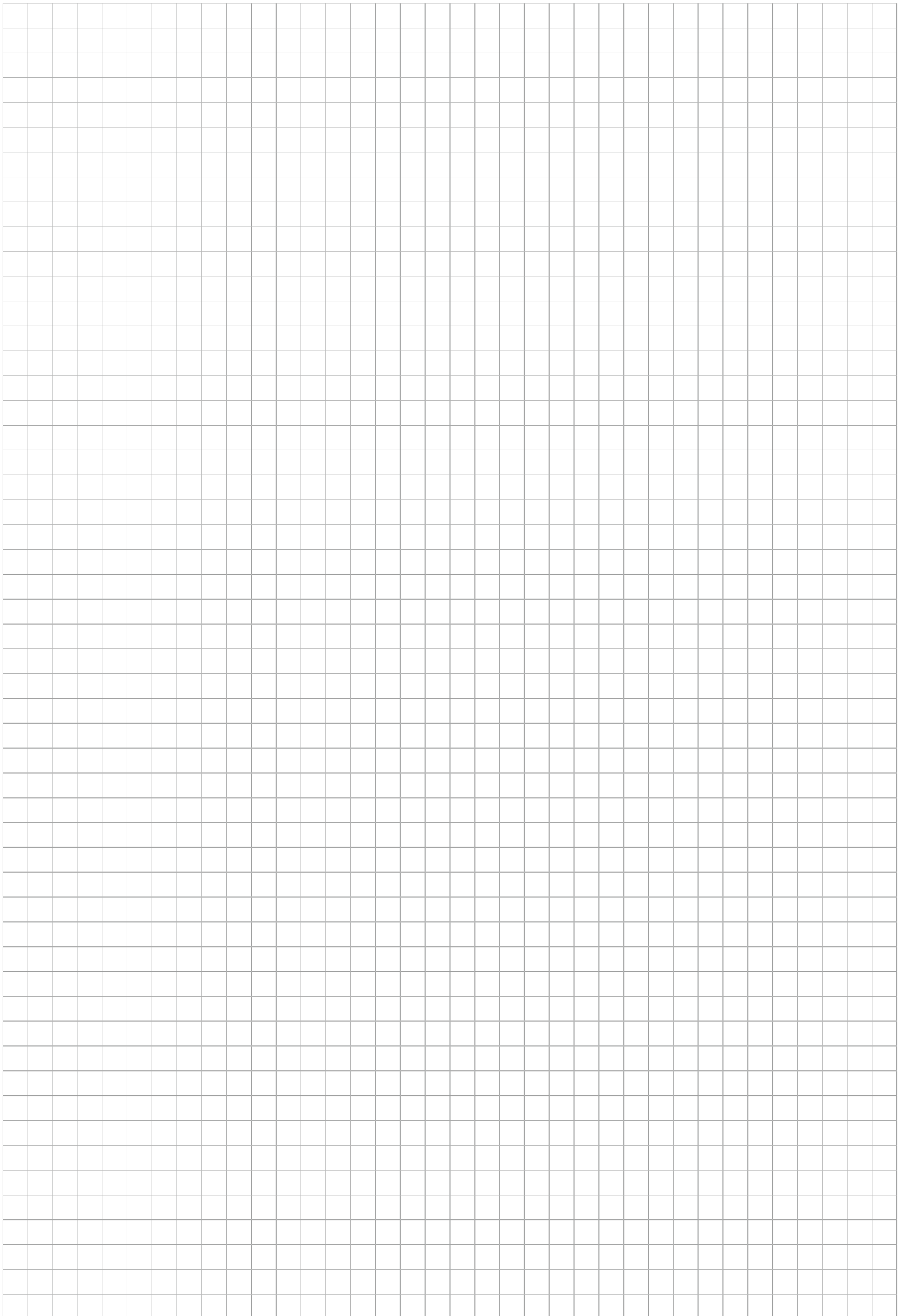

# ILLUSTRATIONS DISC BRAKE PADS

Illustrations plaquettes de frein à disque / Illustrazioni pastiglie freno

Figuras Calços do travão de disco / Rysunki okładzin hamulców tarczowych

Zobrazení obložení kotoučových brzd

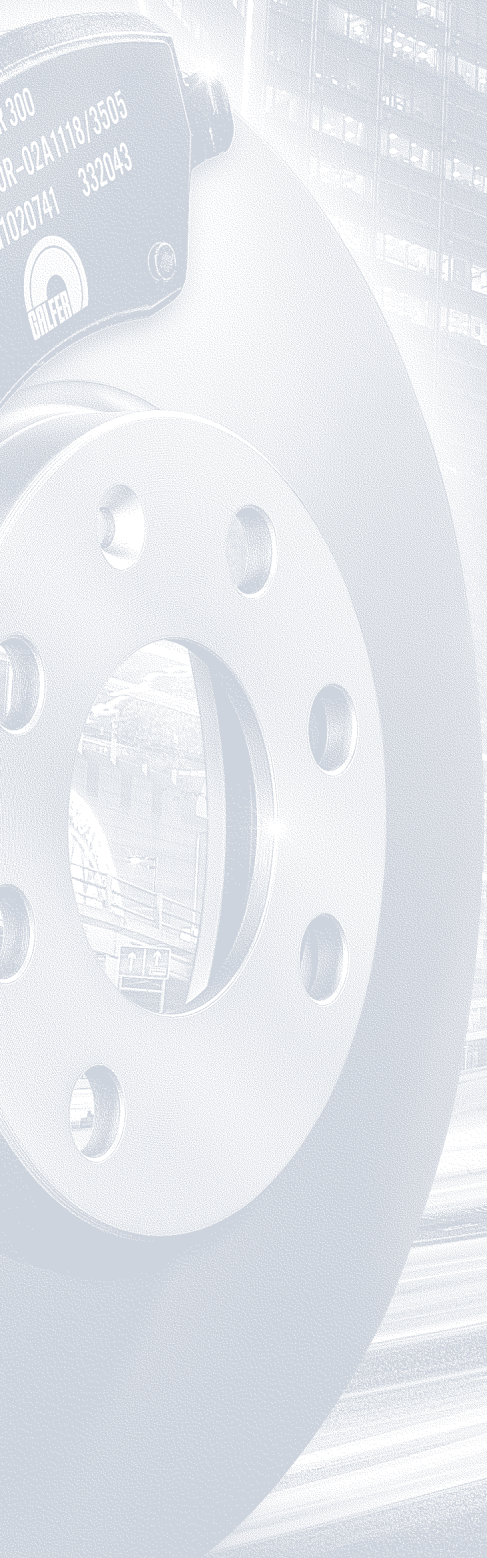

# Illustrations disc brake pads

Illustrations plaquettes de frein à disque / Illustrazioni pastiglie freno /  
 Figuras Calços do travão de disco / Rysunki okładzin hamulców tarczowych /  
 Zobrazení obložení kotoučových brzd

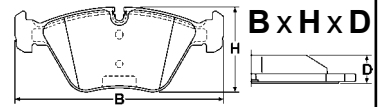

scale - échelle - scala - escala - skala - měřítko 1:2

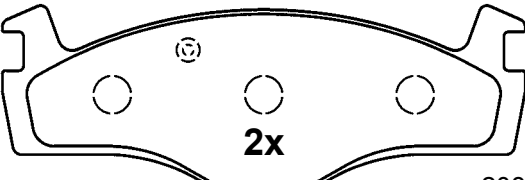
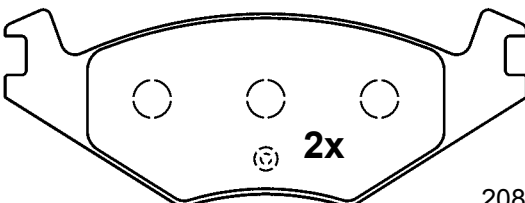
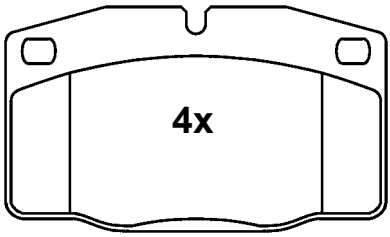
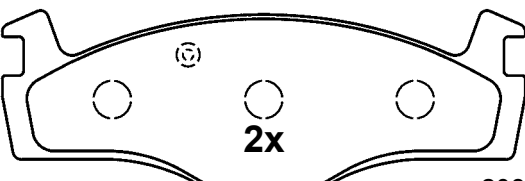
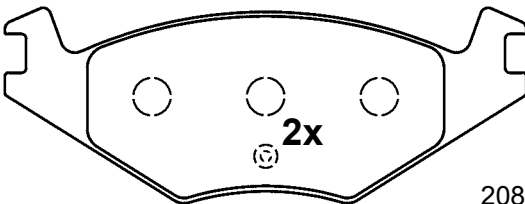
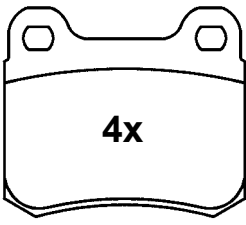





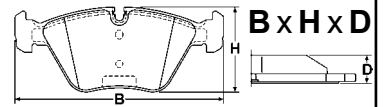





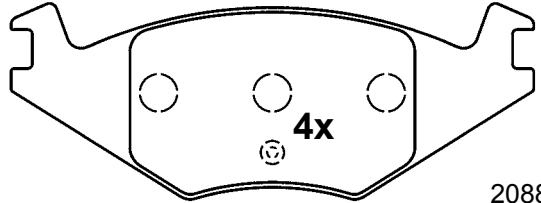
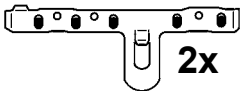
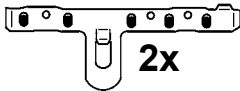

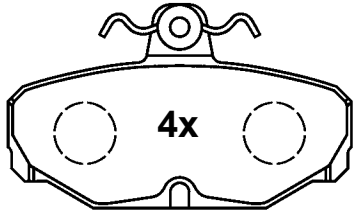
<b>B1.G102-0009.2 G1020009</b>	<b>B1.G102-0015.2 G1020015</b>
<div style="display: flex; justify-content: space-between;"> <div data-bbox="71 324 478 380">  SEAT, VOLKSWAGEN                 </div> <div data-bbox="646 324 774 380">  VW                 </div> </div> <div style="text-align: center; margin-top: 20px;">  <p><b>2x</b></p> <p>20887 19,7</p> <p><b>137,8 x 48,9 x 19,7</b></p>  <p><b>2x</b></p> <p>20888 19,7</p> <p><b>137,8 x 51,5 x 19,7</b></p> <div style="display: flex; justify-content: space-around; margin-top: 20px;"> <div data-bbox="71 1064 311 1153"> <p><b>2x</b></p> </div> <div data-bbox="534 1064 774 1153"> <p><b>2x</b></p> </div> </div> </div>	<div style="display: flex; justify-content: space-between;"> <div data-bbox="813 324 1181 380">  OPEL, VAUXHALL                 </div> <div data-bbox="1396 324 1532 380">  DEL                 </div> </div> <div style="text-align: center; margin-top: 20px;">  <p><b>4x</b></p> <p>20939 15,8</p> <p><b>100,0 x 59,0 x 15,8</b></p> </div>
<b>B1.G102-0010.2 G1020010</b>	<b>B1.G102-0022.2 G1020022</b>
<div style="display: flex; justify-content: space-between;"> <div data-bbox="71 1265 478 1321">  SEAT, VOLKSWAGEN                 </div> <div data-bbox="646 1254 774 1321">  VW                 </div> </div> <div style="text-align: center; margin-top: 20px;">  <p><b>2x</b></p> <p>20887 15,3</p> <p><b>137,8 x 48,9 x 15,3</b></p>  <p><b>2x</b></p> <p>20888 15,3</p> <p><b>137,8 x 51,5 x 15,3</b></p> <div style="display: flex; justify-content: space-around; margin-top: 20px;"> <div data-bbox="71 2016 311 2105"> <p><b>2x</b></p> </div> <div data-bbox="534 2016 774 2105"> <p><b>2x</b></p> </div> </div> </div>	<div style="display: flex; justify-content: space-between;"> <div data-bbox="813 1265 1181 1321">  MERCEDES BENZ                 </div> <div data-bbox="1396 1254 1532 1321">  ATE                 </div> </div> <div style="text-align: center; margin-top: 20px;">  <p><b>4x</b></p> <p>20687 13,5</p> <p><b>61,8 x 54,3 x 13,5</b></p> </div>

# Illustrations disc brake pads

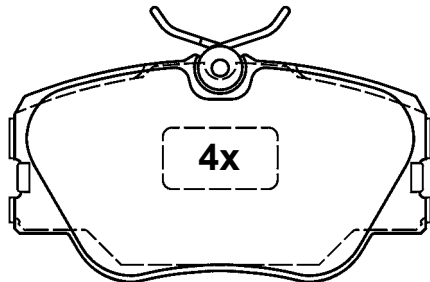
Illustrations plaquettes de frein à disque / Illustrazioni pastiglie freno /  
 Figuras Calços do travão de disco / Rysunki okładzin hamulców tarczowych /  
 Zobrazení obložení kotoučových brzd

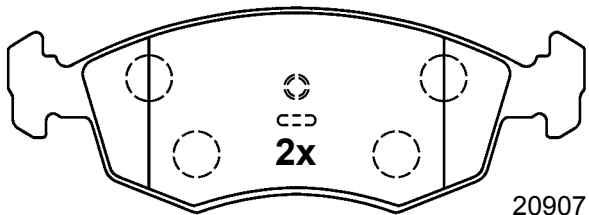
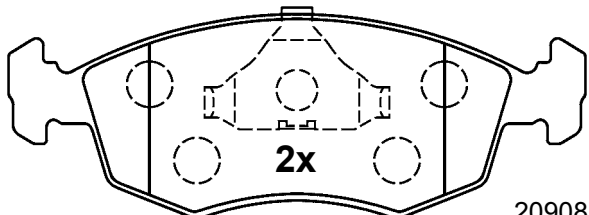

scale - échelle - scala - escala - skala - měřítko 1:2

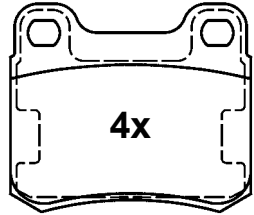





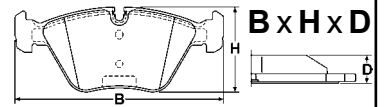

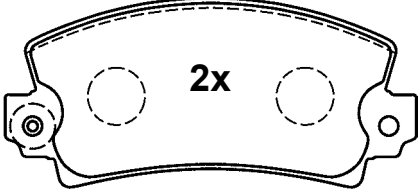
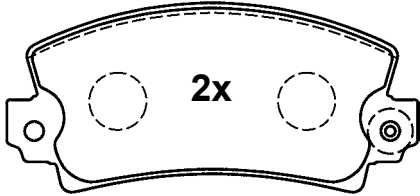

B1.G102-0025.2 G1020025	B1.G102-0028.2 G1020028	
<p> SEAT, VOLKSWAGEN </p>  <p>20889 17,3</p> <p>137,8 x 51,5 x 17,3</p>  2x  2x	<p> FORD </p>  <p>20981 13,8</p>  2x M8x21 <b>90,0 x 53,8 x 13,8</b>	
B1.G102-0044.2 G1020044		
	<p> MERCEDES BENZ </p>  <p>20941 19,3 (21028)</p>  2x M8x21 <b>110,0 x 59,6 x 19,3</b>	
B1.G102-0026.2 G1020026		
<p> FORD </p>  <p>20907 18,0</p>  <p>20908 18,0</p> <p>151,3 x 52,5 x 18,0</p>	<th data-bbox="794 1500 1551 1576">B1.G102-0046.2 G1020046</th> <p> MERCEDES BENZ </p>  <p>20687 15,5</p> <p>61,8 x 54,3 x 15,5</p>	B1.G102-0046.2 G1020046

# Illustrations disc brake pads

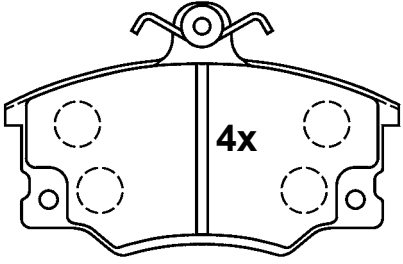
Illustrations plaquettes de frein à disque / Illustrazioni pastiglie freno /  
 Figuras Calços do travão de disco / Rysunki okładzin hamulców tarczowych /  
 Zobrazení obložení kotoučových brzd

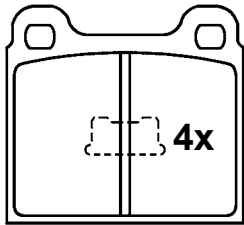

scale - échelle - scala - escala - skala - měřítko 1:2

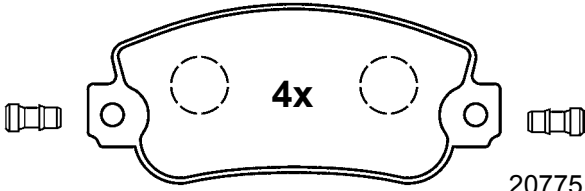
B1.G102-0065.2 G1020065	B1.G102-0140.2 G1020140
<p> PEUGEOT, RENAULT, TALBOT  BDX</p>  20140 14,0  20141 14,0 <p>108,8 x 49,3 x 14,0</p>	<p> ALFA ROMEO, AUTOBIANCHI, FIAT, LANCIA  LUC</p>  20838 17,0 <p>(20833) (20734) (20839)</p>  4x  2x <p>M8x21</p> <p>104,0 x 67,0 x 17,0</p>
B1.G102-0097.2 G1020097	B1.G102-0141.2 G1020141
<p> AUDI, VOLKSWAGEN  ATE</p>  20228 15,3 <p>61,8 x 56,8 x 15,3</p>	<p> AUTOBIANCHI, FIAT, LANCIA, SEAT  BDX</p>  20775 18,0 <p>(20776/20777)</p> <p>109,0 x 47,4 x 18,0</p>



# Illustrations disc brake pads

Illustrations plaquettes de frein à disque / Illustrazioni pastiglie freno /  
 Figuras Calços do travão de disco / Rysunki okładzin hamulców tarczowych /  
 Zobrazení obložení kotoučových brzd

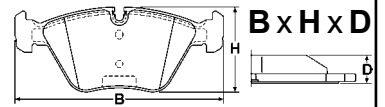

scale - échelle - scala - escala - skala - měřítko 1:2

## B1.G102-0147.2 G1020147



ALFA ROMEO, FIAT, PEUGEOT



LUC

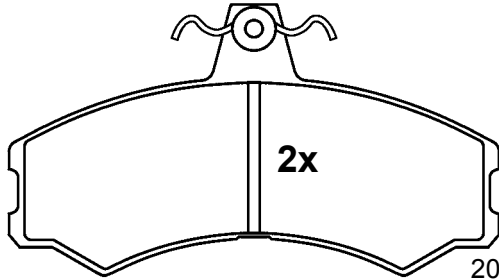

20741 19,0

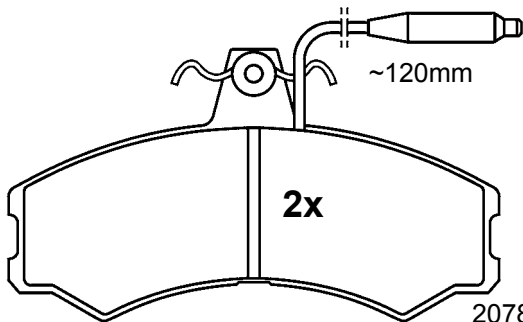

20787 19,0



130,0 x 71,4 x 19,0

## B1.G102-0196.2 G1020196



AUDI



LUC

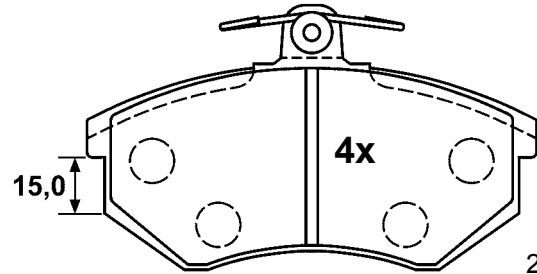

20669 19,0



119,0 x 69,5 x 19,0

## B1.G102-0197.2 G1020197



AUDI



LUC

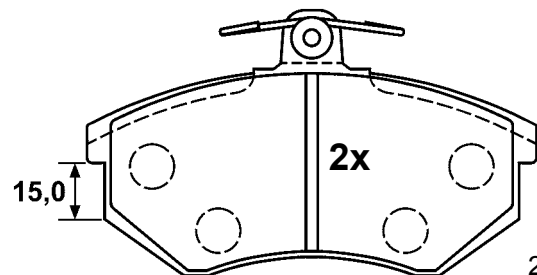

20669 19,0

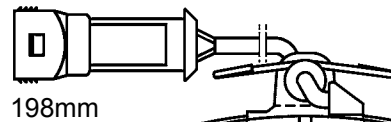

198mm

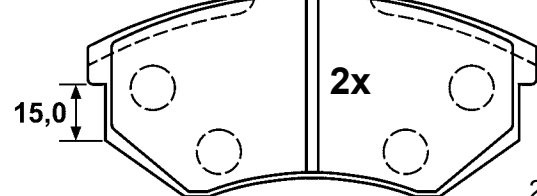

20901 19,0



119,0 x 69,5 x 19,0

## B1.G102-0184.2 G1020184



FIAT, LANCIA



LUC

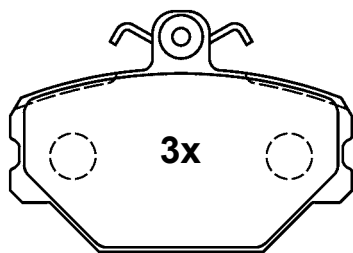

21100 16,7

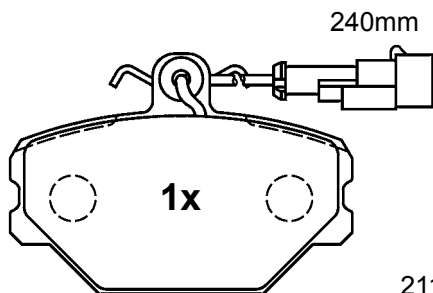

21105 16,7



90,0 x 63,0 x 16,7

# Illustrations disc brake pads

Illustrations plaquettes de frein à disque / Illustrazioni pastiglie freno /  
Figuras Calços do travão de disco / Rysunki okładzin hamulców tarczowych /  
Zobrazení obložení kotoučových brzd

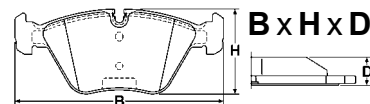

scale - échelle - scala - escala - skala - měřítko 1:2

## B1.G102-0201.2 G1020201



PEUGEOT, SEAT, VOLKSWAGEN



LUC

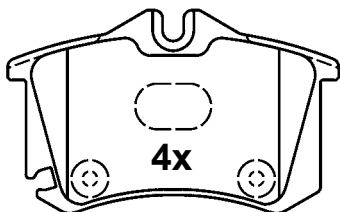

20961 15,2

87,2 x 52,9 x 15,2

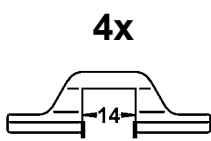
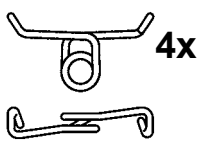

## B1.G102-0214.2 G1020214



PEUGEOT, RENAULT



BDX

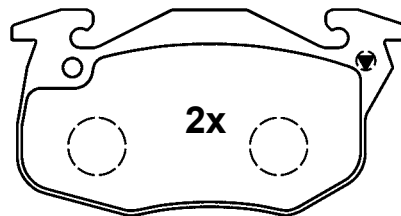

20905 18,0  
(20986)

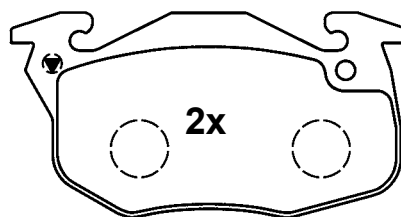

20906 18,0  
(20987)

105,0 x 54,3 x 18,0

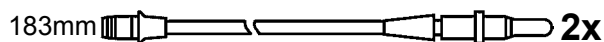

## B1.G102-0213.2 G1020213



PEUGEOT



LUC

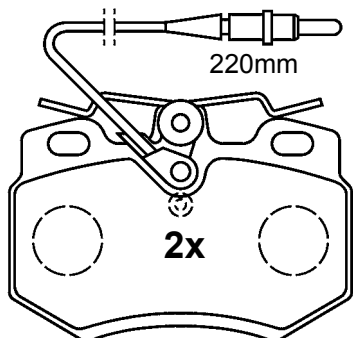

20989 17,7

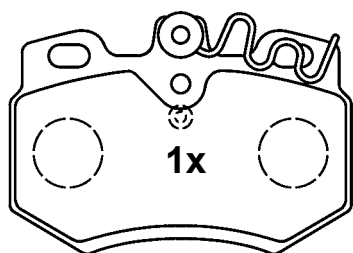

21022 17,7

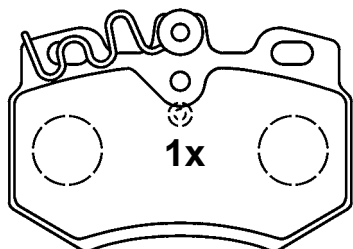

21023 17,7

90,0 x 62,9 x 17,7

## B1.G102-0215.2 G1020215



CITROEN, PEUGEOT



BDX

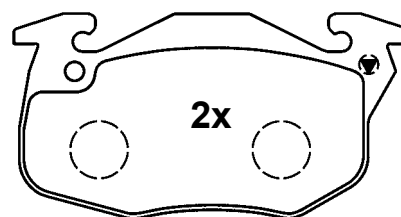

20905 18,0

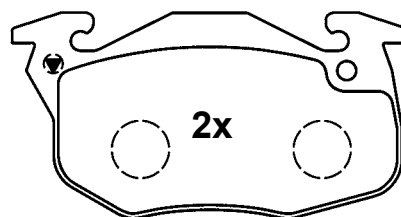

20906 18,0

105,0 x 54,3 x 18,0

# Illustrations disc brake pads

Illustrations plaquettes de frein à disque / Illustrazioni pastiglie freno /  
 Figuras Calços do travão de disco / Rysunki okładzin hamulców tarczowych /  
 Zobrazení obložení kotoučových brzd

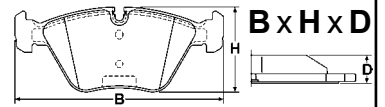

scale - échelle - scala - escala - skala - měřítko 1:2

<b>B1.G102-0216.2 G1020216</b>	<b>B1.G102-0236.2 G1020236</b>
--------------------------------	--------------------------------

CITROEN, PEUGEOT, RENAULT

ALFA ROMEO, FIAT, LANCIA

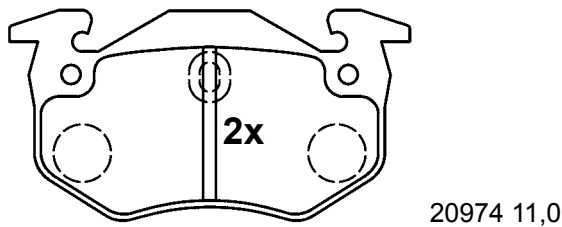
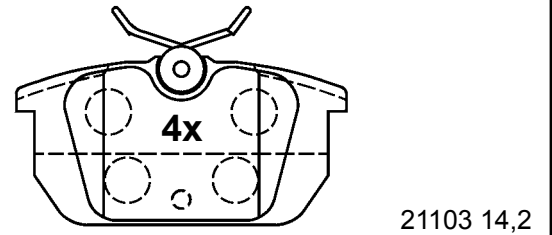
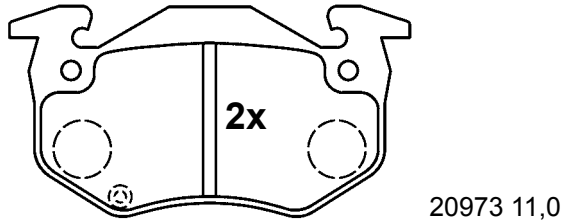

105,0 x 54,9 x 11,0

87,0 x 44,6 x 14,2

<b>B1.G102-0219.2 G1020219</b>	<b>B1.G102-0246.2 G1020246</b>
--------------------------------	--------------------------------

RENAULT

AUDI

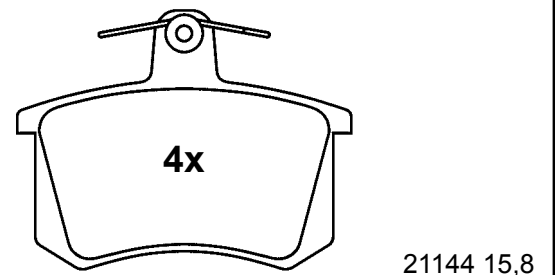
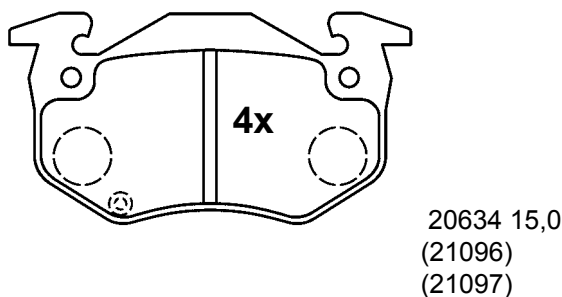

105,0 x 54,9 x 15,0

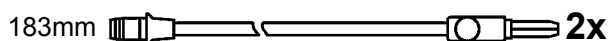

87,6 x 66,8 x 15,8

# Illustrations disc brake pads

Illustrations plaquettes de frein à disque / Illustrazioni pastiglie freno /  
 Figuras Calços do travão de disco / Rysunki okładzin hamulców tarczowych /  
 Zobrazení obložení kotoučových brzd

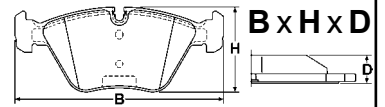

scale - échelle - scala - escala - skala - měřítko 1:2

<b>B1.G102-0257.2 G1020257</b>	<b>B1.G102-0259.2 G1020259</b>
--------------------------------	--------------------------------

**MERCEDES BENZ** **LUC**

**FIAT** **BDX**

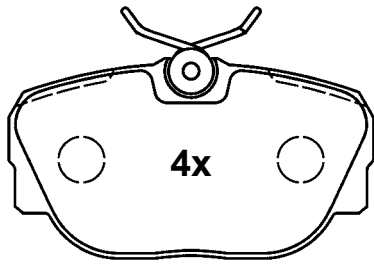

21055 17,0

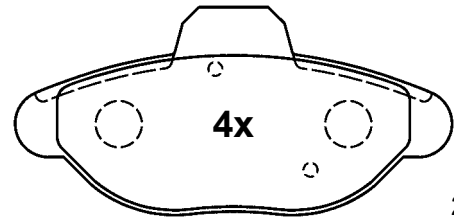

21365 17,0



94,7 x 51,9 x 17,0

114,8 x 54,8 x 17,0

<b>B1.G102-0258.2 G1020258</b>	<b>B1.G102-0265.2 G1020265</b>
--------------------------------	--------------------------------

**CHEVROLET, DAEWOO, OPEL, VAUXHALL** **ATE**

**FORD** **ATE**

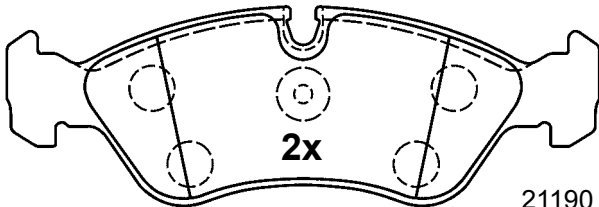

21190 17,5

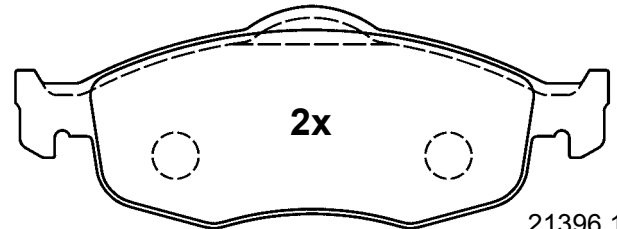

21396 17,5

156,3 x 58,5 x 17,5

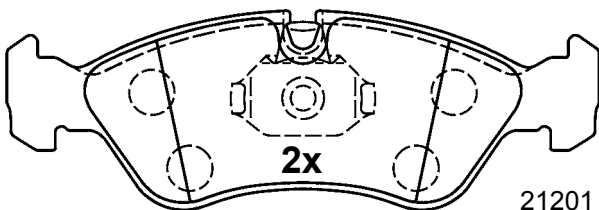

21201 17,5

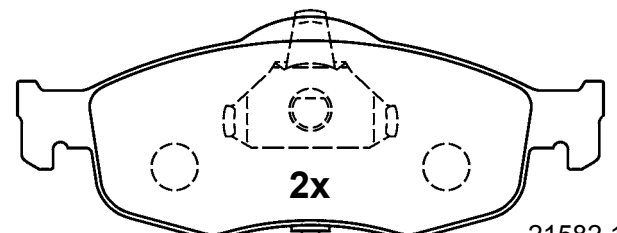

21582 17,5

~205mm

155,1 x 58,5 x 17,5

156,3 x 52,3 x 17,5







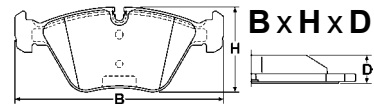



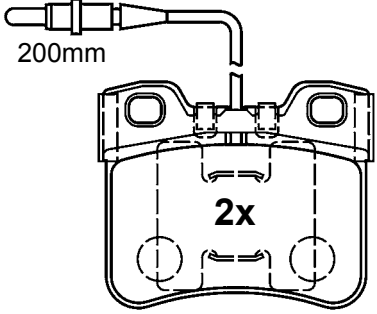
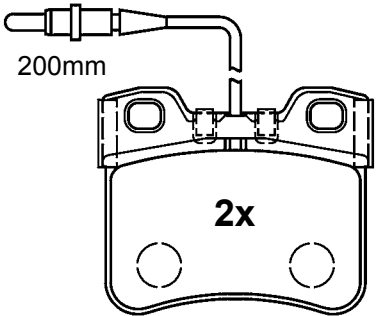

# Illustrations disc brake pads

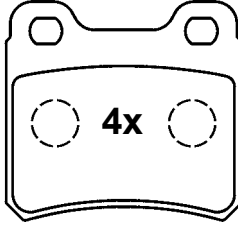
Illustrations plaquettes de frein à disque / Illustrazioni pastiglie freno /  
 Figuras Calços do travão de disco / Rysunki okładzin hamulców tarczowych /  
 Zobrazení obložení kotoučových brzd

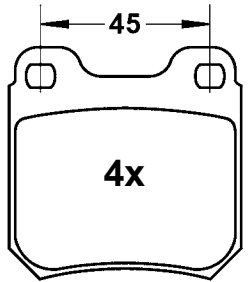

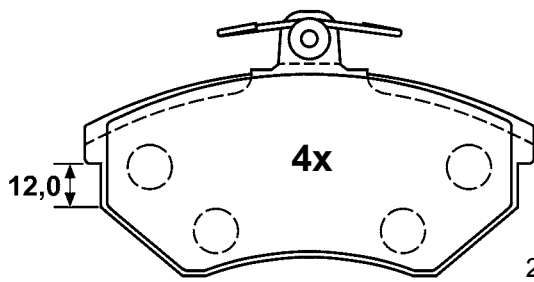
scale - échelle - scala - escala - skala - měřítko 1:2







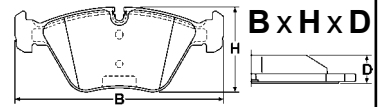

<b>B1.G102-0269.2 G1020269</b>	<b>B1.G102-0272.2 G1020272</b>
<div style="display: flex; justify-content: space-between;"> <div style="text-align: left;">  <p><b>CITROEN</b></p> </div> <div style="text-align: right;">  <p><b>ATE</b></p> </div> </div> <div style="text-align: center; margin-top: 20px;">  <p><b>2x</b></p> <p>21289 16,8</p>  <p><b>2x</b></p> <p>21179 16,8</p> <p><b>72,9 x 60,6 x 16,8</b></p> </div>	<div style="display: flex; justify-content: space-between;"> <div style="text-align: left;">  <p><b>OPEL, SAAB, VAUXHALL</b></p> </div> <div style="text-align: right;">  <p><b>ATE</b></p> </div> </div> <div style="text-align: center; margin-top: 20px;">  <p><b>4x</b></p> <p>21140 15,0</p> <p><b>61,7 x 57,5 x 15,0</b></p> </div>
<b>B1.G102-0271.2 G1020271</b>	<b>B1.G102-0273.2 G1020273</b>
<div style="display: flex; justify-content: space-between;"> <div style="text-align: left;">  <p><b>OPEL, SAAB, VAUXHALL</b></p> </div> <div style="text-align: right;">  <p><b>ATE</b></p> </div> </div> <div style="text-align: center; margin-top: 20px;">  <p><b>4x</b></p> <p>21050 15,0</p> <p><b>61,6 x 61,2 x 15,0</b></p> </div>	<div style="display: flex; justify-content: space-between;"> <div style="text-align: left;">  <p><b>SEAT, VOLKSWAGEN</b></p> </div> <div style="text-align: right;">  <p><b>LUC</b></p> </div> </div> <div style="text-align: center; margin-top: 20px;">  <p><b>4x</b></p> <p>20168 16,0</p> <div style="margin-top: 20px;">  <p><b>2x</b></p> <p><b>M8x21</b></p> </div> <p><b>119,0 x 69,5 x 16,0</b></p> </div>

# Illustrations disc brake pads

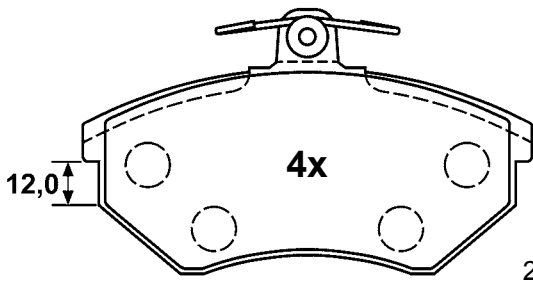
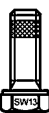
Illustrations plaquettes de frein à disque / Illustrazioni pastiglie freno /  
 Figuras Calços do travão de disco / Rysunki okładzin hamulców tarczowych /  
 Zobrazení obložení kotoučových brzd

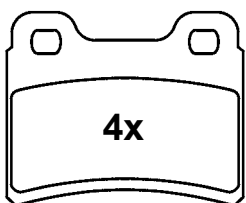

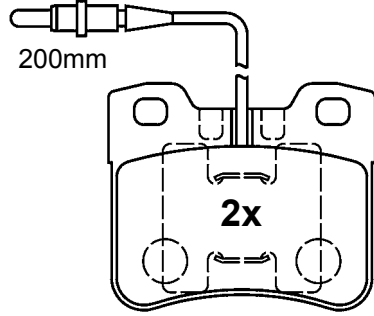
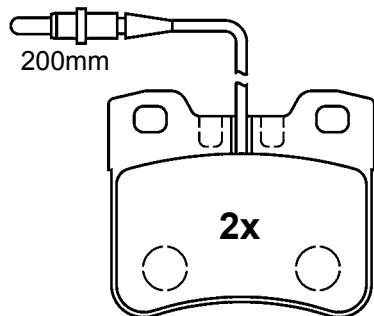
scale - échelle - scala - escala - skala - měřítko 1:2

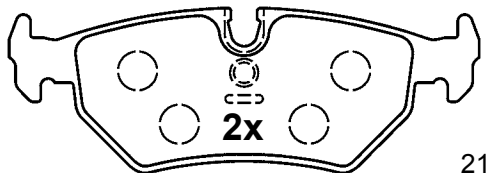
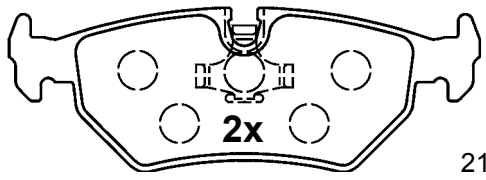
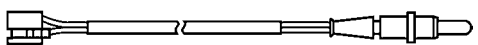
B1.G102-0274.2 G1020274	B1.G102-0290.2 G1020290
<p> SEAT, VOLKSWAGEN</p> <p> LUC</p>  <p>12,0</p> <p>4x</p> <p>20168 19,3</p> <p> 2x</p> <p>M8x21</p> <p>119,0 x 69,5 x 19,3</p>	<p> FORD</p> <p> ATE</p>  <p>4x</p> <p>21832 14,9</p> <p>61,7 x 51,1 x 14,9</p>
B1.G102-0275.2 G1020275	B1.G102-0291.2 G1020291
<p> CITROEN, PEUGEOT</p> <p> ATE</p>  <p>200mm</p> <p>2x</p> <p>21267 16,8</p>  <p>200mm</p> <p>2x</p> <p>21191 16,8</p> <p>71,9 x 60,6 x 16,8</p>	<p> CITROEN, FIAT, LANCIA, PEUGEOT</p> <p> ATE</p>  <p>2x</p> <p>21275 17,0</p>  <p>2x</p> <p>21276 17,0</p> <p>123,0 x 43,0 x 17,0</p> <p>300mm  2x</p>

# Illustrations disc brake pads

Illustrations plaquettes de frein à disque / Illustrazioni pastiglie freno /

Figuras Calços do travão de disco / Rysunki okładzin hamulców tarczowych /

Zobrazení obložení kotoučových brzd

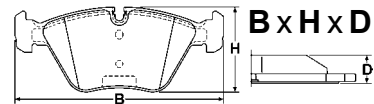

scale - échelle - scala - escala - skala - měřítko 1:2

## B1.G102-0292.2 G1020292



PEUGEOT



ATE

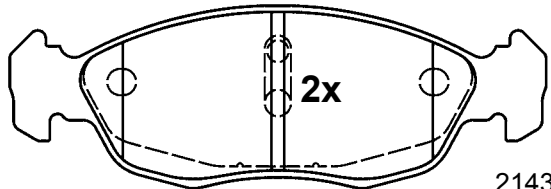

21430 17,3

141,3 x 47,4 x 17,3

270mm

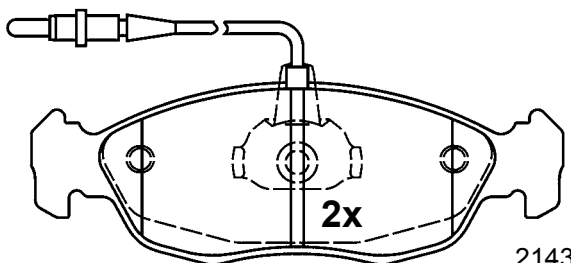

21432 17,3

140,1 x 47,4 x 17,3

## B1.G102-0295.2 G1020295



CITROEN, PEUGEOT



BDX

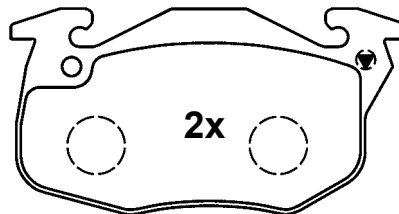

20905 18,0

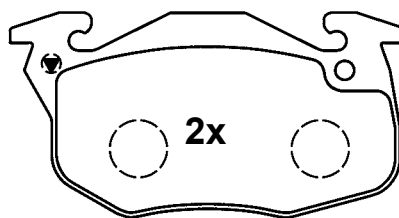

20906 18,0

105,0 x 54,3 x 18,0

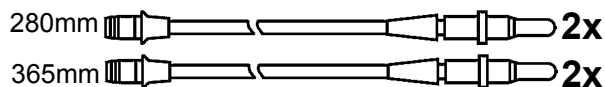

280mm 2x

365mm 2x

## B1.G102-0293.2 G1020293



CITROEN, PEUGEOT



ATE

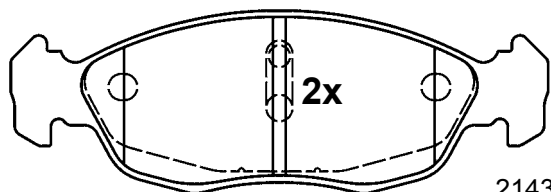

21430 17,3

141,3 x 47,4 x 17,3

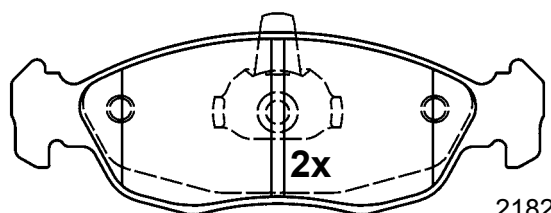

21827 17,3

140,1 x 47,4 x 17,3

## B1.G102-0296.2 G1020296



PEUGEOT



BDX

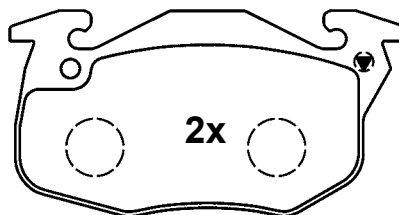

20905 18,0

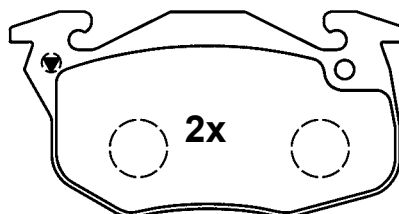

20906 18,0

105,0 x 54,3 x 18,0

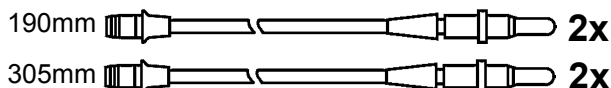

190mm 2x

305mm 2x

# Illustrations disc brake pads

Illustrations plaquettes de frein à disque / Illustrazioni pastiglie freno /  
 Figuras Calços do travão de disco / Rysunki okładzin hamulców tarczowych /  
 Zobrazení obložení kotoučových brzd

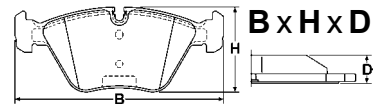

scale - échelle - scala - escala - skala - měřítko 1:2

## B1.G102-0298.2 G1020298



FIAT, LANCIA



BDX

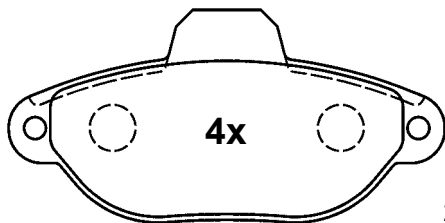

21436 16,2

114,8 x 55,5 x 16,2

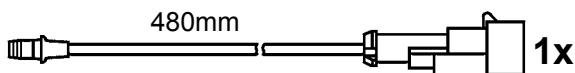

## B1.G102-0301.2 G1020301



CITROEN, FIAT, PEUGEOT



LUC

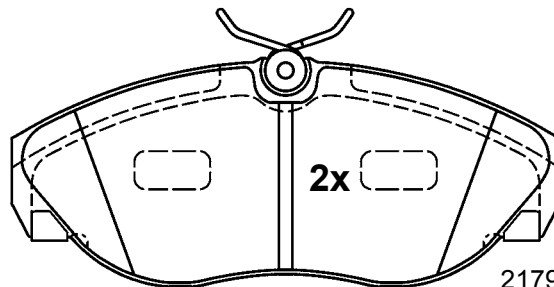

21797 19,7

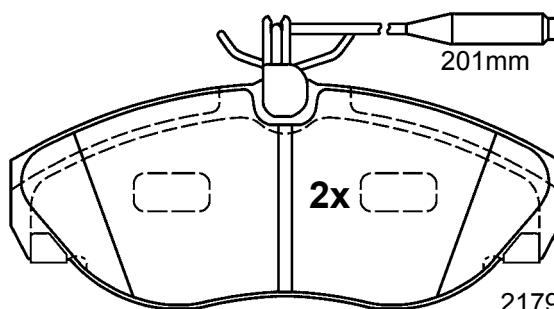

21798 19,7



M8x21

144,8 x 60,8 x 19,7

## B1.G102-0299.2 G1020299



CITROEN



LUC

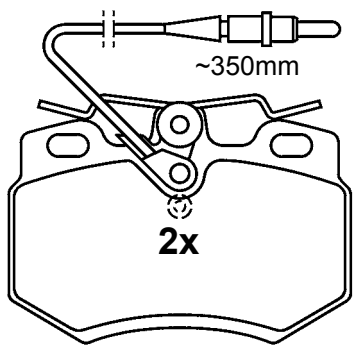

21616 17,7

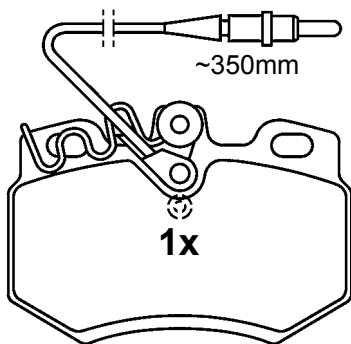

21614 17,7

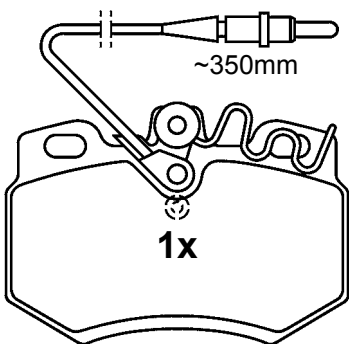

21615 17,7

89,9 x 62,9 x 17,7

## B1.G102-0302.2 G1020302



CITROEN, FIAT, PEUGEOT



LUC

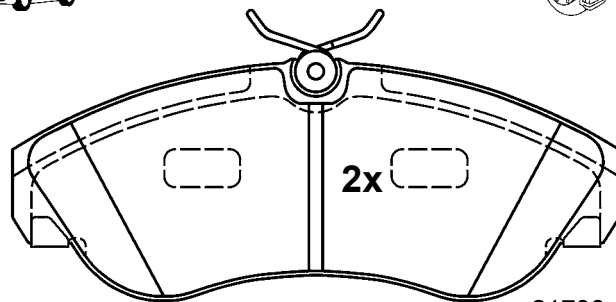

21799 19,7

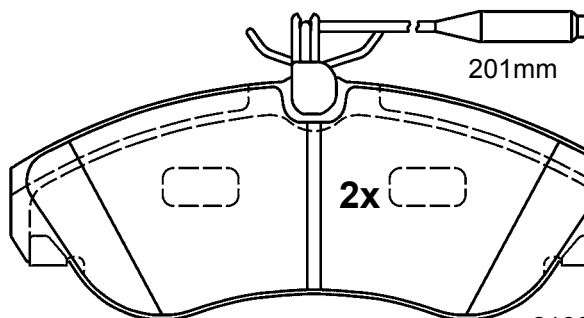

21800 19,7



M8x21

159,8 x 64,1 x 19,7



# Illustrations disc brake pads

Illustrations plaquettes de frein à disque / Illustrazioni pastiglie freno /  
Figuras Calços do travão de disco / Rysunki okładzin hamulców tarczowych /  
Zobrazení obložení kotoučových brzd

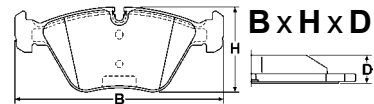

scale - échelle - scala - escala - skala - měřítko 1:2

## B1.G102-0304.2 G1020304



VOLKSWAGEN



LUC

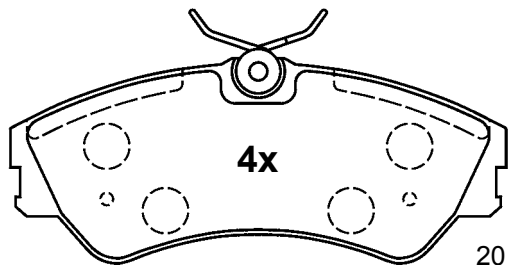

20124 18,9



129,8 x 54,5 x 18,9

## B1.G102-0310.2 G1020310



CITROEN, FIAT, LANCIA,  
PEUGEOT



LUC

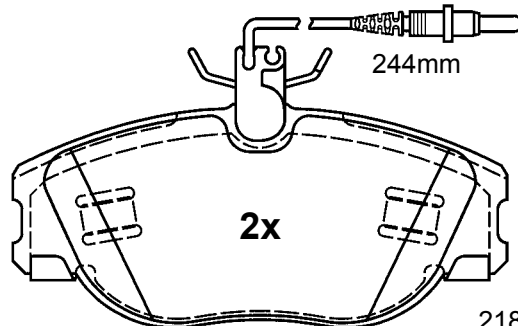

21801 19,0

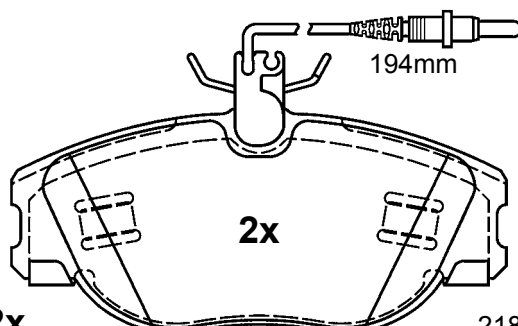

21802 19,0



129,8 x 58,7 x 19,0

## B1.G102-0305.2 G1020305



FIAT, LANCIA



BDX

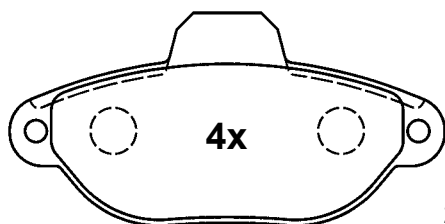

21436 16,2

114,8 x 55,5 x 16,2

## B1.G102-0311.2 G1020311



AUDI



ATE

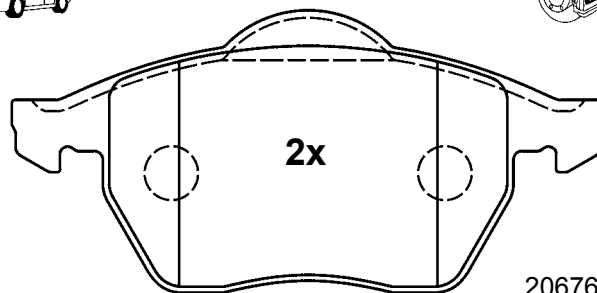

20676 19,5

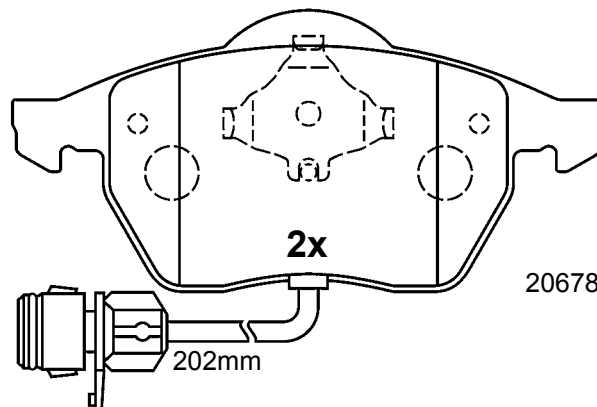

20678 19,5

156,3 x 74,0 x 19,5

## B1.G102-0308.2 G1020308



BMW



ATE

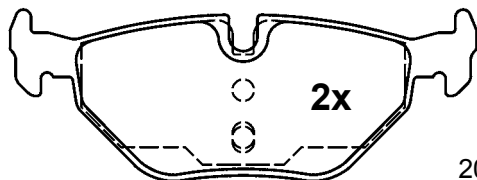

20995 17,1

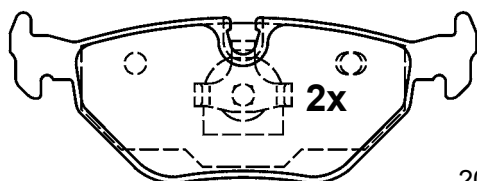

20996 17,1

123,0 x 44,9 x 17,1

# Illustrations disc brake pads

Illustrations plaquettes de frein à disque / Illustrazioni pastiglie freno /  
 Figuras Calços do travão de disco / Rysunki okładzin hamulców tarczowych /  
 Zobrazení obložení kotoučových brzd

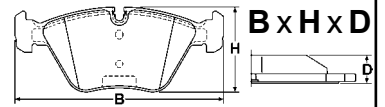

scale - échelle - scala - escala - skala - měřítko 1:2

## B1.G102-0312.2 G1020312

AUDI, FORD, SEAT, VOLKSWAGEN ATE

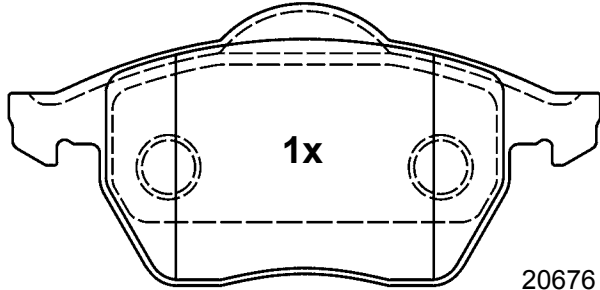

**156,3 x 74,0 x 19,8**

20676 19,8

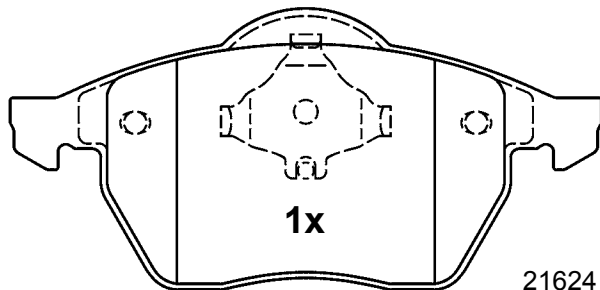

**156,3 x 74,0 x 20,3**

21624 20,3  
21646 20,3

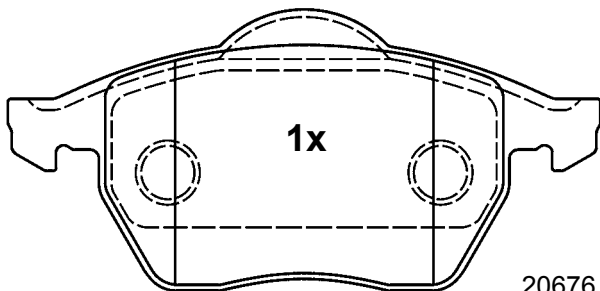

**156,3 x 74,0 x 19,8**

20676 19,8

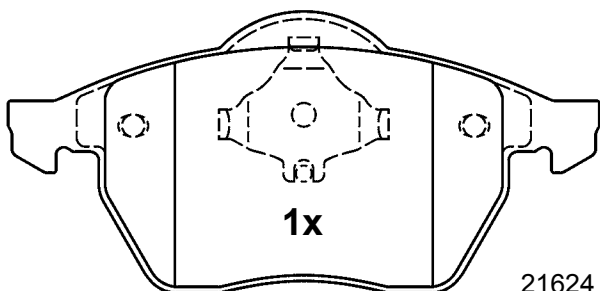

**156,3 x 74,0 x 20,3**

21624 20,3  
21646 20,3

## B1.G102-0313.2 G1020313

AUDI, SEAT, SKODA, VOLKSWAGEN ATE

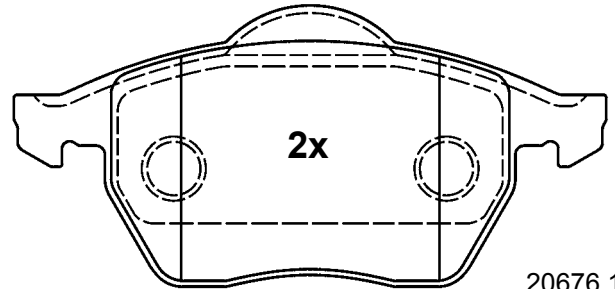

**156,3 x 74,0 x 19,8**

20676 19,8

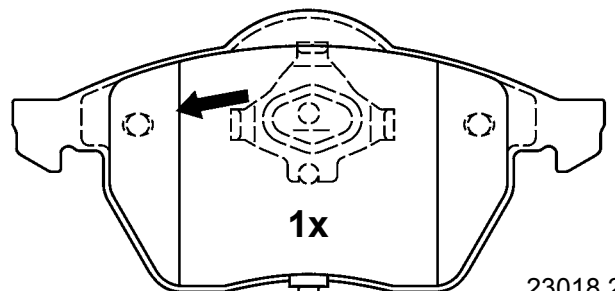

**156,3 x 74,0 x 20,3**

23018 20,3

200mm

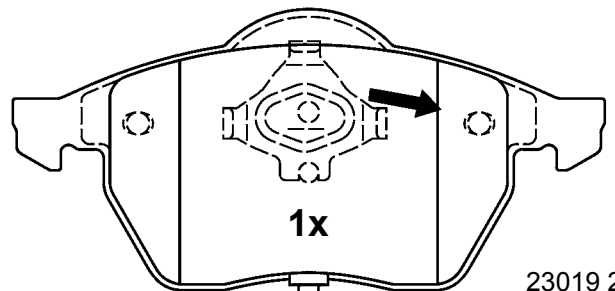

**156,3 x 74,0 x 20,3**

23019 20,3

200mm

# Illustrations disc brake pads

Illustrations plaquettes de frein à disque / Illustrazioni pastiglie freno /  
 Figuras Calços do travão de disco / Rysunki okładzin hamulców tarczowych /  
 Zobrazení obložení kotoučových brzd

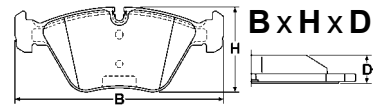

scale - échelle - scala - escala - skala - měřítko 1:2

<b>B1.G102-0315.2 G1020315</b>	<b>B1.G102-0317.2 G1020317</b>
--------------------------------	--------------------------------

**VOLKSWAGEN** **LUC**

**2x**

20651 18,0

**91,6 x 80,0 x 18,0**

**2x**

21635 18,0

**91,6 x 80,0 x 18,0**

**CHEVROLET, DAEWOO, OPEL, VAUXHALL** **ATE**

**2x**

20547 16,5

**141,3 x 48,4 x 16,5**

**2x**

21353 16,5

**140,1 x 58,3 x 16,5**

**B1.G102-0316.2 G1020316**

**BMW, MG, ROVER, SAAB** **ATE**

**2x**

20180 17,1

**2x**

20181 17,1

**123,0 x 44,9 x 17,1**

**B1.G102-0320.2 G1020320**

**FORD** **ATE**

**2x**

21396 17,5

**156,3 x 58,5 x 17,5**

**2x**

21394 17,5

**155,1 x 58,5 x 17,5**

# Illustrations disc brake pads

Illustrations plaquettes de frein à disque / Illustrazioni pastiglie freno /  
 Figuras Calços do travão de disco / Rysunki okładzin hamulców tarczowych /  
 Zobrazení obložení kotoučových brzd

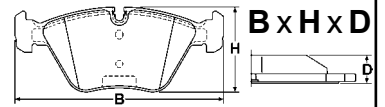

scale - échelle - scala - escala - skala - měřítko 1:2

<b>B1.G102-0323.2 G1020323</b>	<b>B1.G102-0327.2 G1020327</b>
--------------------------------	--------------------------------

**RENAULT**
**BDX**

**4x**

20634 15,0

**2x**

20410 15,0

**2x**

20423 15,0

**105,0 x 54,9 x 15,0**

**RENAULT**
**BRE**

**2x**

20410 15,0

**2x**

20423 15,0

**125,9 x 58,7 x 15,0**

<b>B1.G102-0326.2 G1020326</b>	<b>B1.G102-0328.2 G1020328</b>
--------------------------------	--------------------------------

**RENAULT**
**LUC**

**2x**

20919 18,0

**2x**

~260mm

21388 18,0

**2x**

**M8x21**

**129,9 x 55,5 x 18,0**

**CITROEN**
**BDX**

**4x**

21631 17,0

**130,7 x 60,0 x 17,0**

155mm **2x**

365mm **2x**



# Illustrations disc brake pads

Illustrations plaquettes de frein à disque / Illustrazioni pastiglie freno /  
 Figuras Calços do travão de disco / Rysunki okładzin hamulców tarczowych /  
 Zobrazení obložení kotoučových brzd

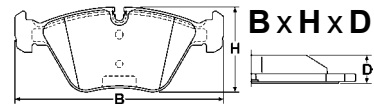

scale - échelle - scala - escala - skala - měřítko 1:2

<b>B1.G102-0329.2 G1020329</b>	<b>B1.G102-0332.2 G1020332</b>
<div style="display: flex; justify-content: space-between;"> <div data-bbox="71 324 319 380">  CITROEN                 </div> <div data-bbox="651 318 785 380">  BRE                 </div> </div> <div style="text-align: center; margin-top: 100px;"> <p><b>4x</b></p> <p>20162 15,4</p> <p><b>54,0 x 64,7 x 15,4</b></p> </div>	<div style="display: flex; justify-content: space-between;"> <div data-bbox="813 324 1133 380">  FORD, MAZDA                 </div> <div data-bbox="1396 318 1528 380">  ATE                 </div> </div> <div style="text-align: center; margin-top: 100px;"> <p><b>2x</b></p> <p>21202 16,9</p> <p><b>141,3 x 44,4 x 16,9</b></p> <p><b>2x</b></p> <p>21203 16,9</p> <p><b>140,1 x 44,4 x 16,9</b></p> </div>
<b>B1.G102-0331.2 G1020331</b>	<b>B1.G102-0334.2 G1020334</b>
<div style="display: flex; justify-content: space-between;"> <div data-bbox="71 1258 462 1332">  AUDI, SEAT, SKODA, VOLKSWAGEN                 </div> <div data-bbox="651 1252 774 1314">  VW                 </div> </div> <div style="text-align: center; margin-top: 100px;"> <p><b>2x</b></p> <p>23130 19,7</p> <p><b>2x</b></p> <p>23131 19,7</p> <p><b>146,0 x 54,7 x 19,7</b></p> </div>	<div style="display: flex; justify-content: space-between;"> <div data-bbox="813 1258 1133 1314">  FORD, MAZDA                 </div> <div data-bbox="1396 1252 1528 1314">  ATE                 </div> </div> <div style="text-align: center; margin-top: 100px;"> <p><b>2x</b></p> <p>20640 17,5</p> <p><b>2x</b></p> <p>20753 17,5</p> <p><b>151,3 x 46,4 x 17,5</b></p> </div>

# Illustrations disc brake pads

Illustrations plaquettes de frein à disque / Illustrazioni pastiglie freno /  
 Figuras Calços do travão de disco / Rysunki okładzin hamulców tarczowych /  
 Zobrazení obložení kotoučových brzd

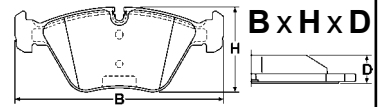

scale - échelle - scala - escala - skala - měřítko 1:2

<b>B1.G102-0337.2 G1020337</b>	<b>B1.G102-0340.2 G1020340</b>
--------------------------------	--------------------------------



MERCEDES BENZ



LUC



FIAT, LANCIA



ATE

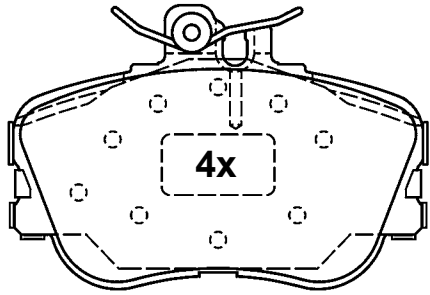

21439 20,3

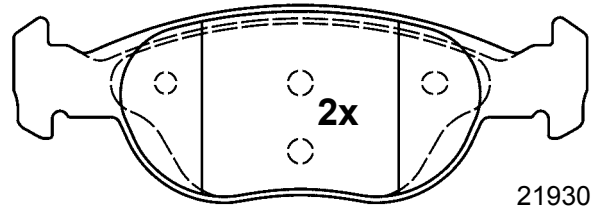

21930 17,9



110,0 x 74,5 x 20,3

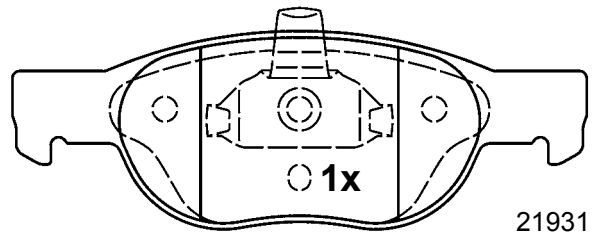

21931 17,9

<b>B1.G102-0339.2 G1020339</b>	
--------------------------------	--



MERCEDES BENZ



ATE

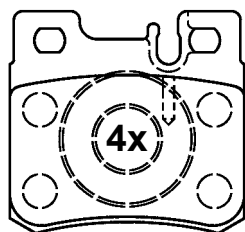

21197 15,0

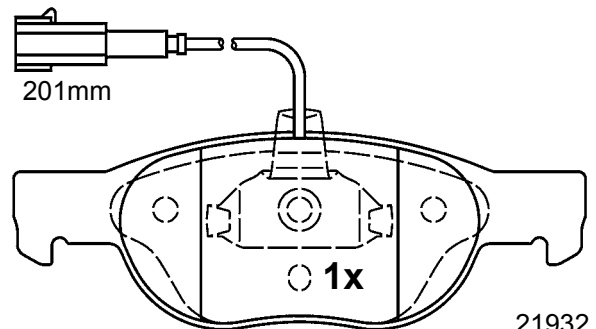

21932 17,9

61,8 x 58,6 x 15,0

151,3 x 52,0 x 17,9



# Illustrations disc brake pads

Illustrations plaquettes de frein à disque / Illustrazioni pastiglie freno /  
 Figuras Calços do travão de disco / Rysunki okładzin hamulców tarczowych /  
 Zobrazení obložení kotoučových brzd

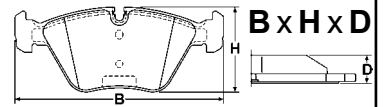

scale - échelle - scala - escala - skala - měřítko 1:2

<b>B1.G102-0342.2 G1020342</b>	<b>B1.G102-0344.2 G1020344</b>
--------------------------------	--------------------------------

**FIAT, LANCIA**

**SEAT, VOLKSWAGEN**

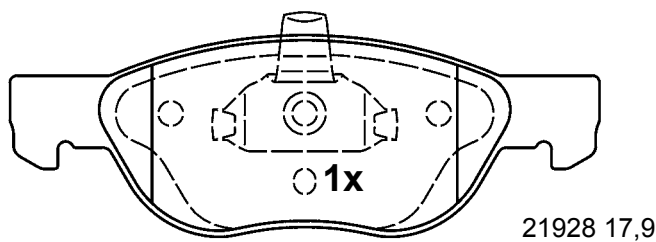
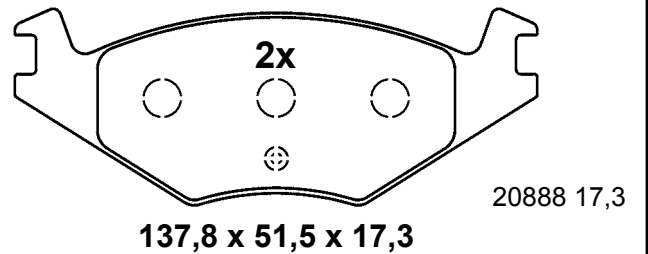
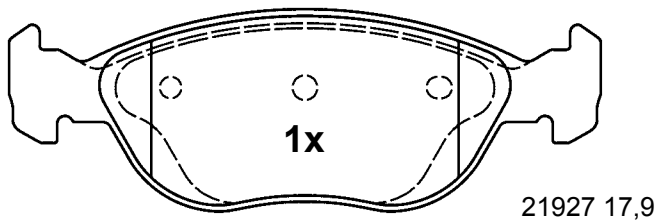
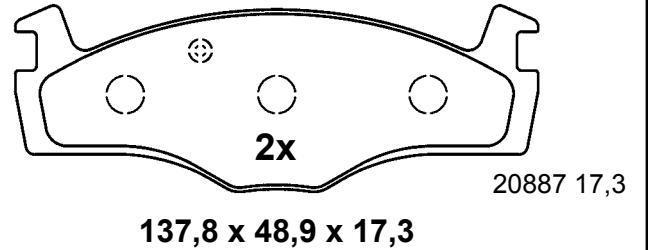
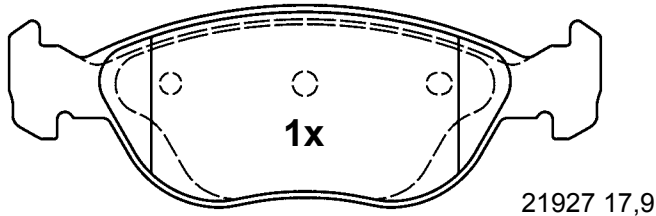

## B1.G102-0345.2 G1020345

**SEAT, VOLKSWAGEN**

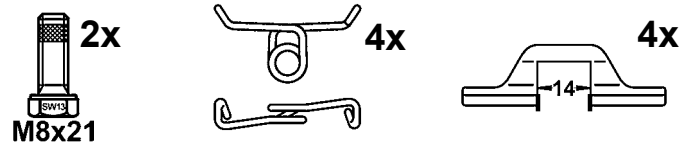
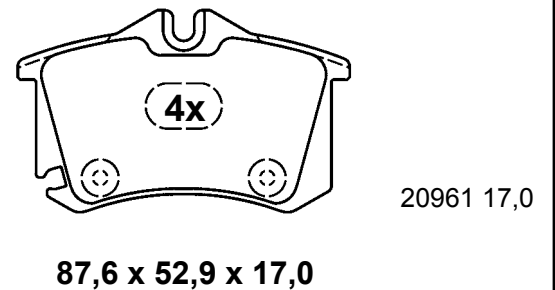
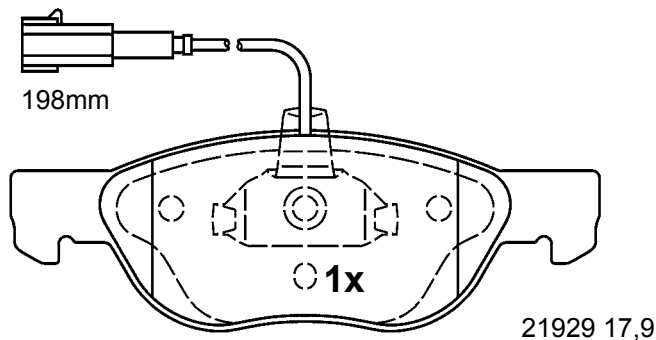

# Illustrations disc brake pads

Illustrations plaquettes de frein à disque / Illustrazioni pastiglie freno /  
 Figuras Calços do travão de disco / Rysunki okładzin hamulców tarczowych /  
 Zobrazení obložení kotoučových brzd

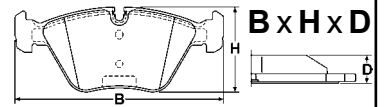

scale - échelle - scala - escala - skala - měřítko 1:2

<b>B1.G102-0347.2 G1020347</b>	<b>B1.G102-0351.2 G1020351</b>
--------------------------------	--------------------------------

VOLKSWAGEN LUC

FIAT, LANCIA ATE

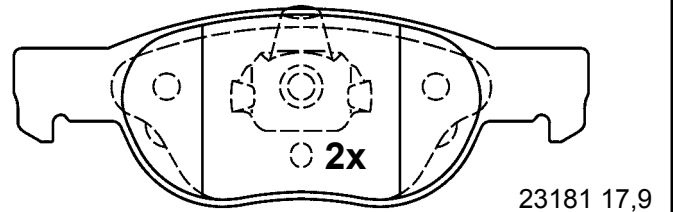
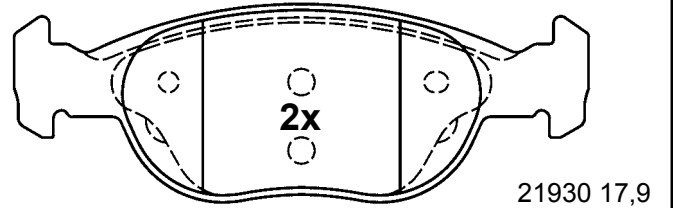
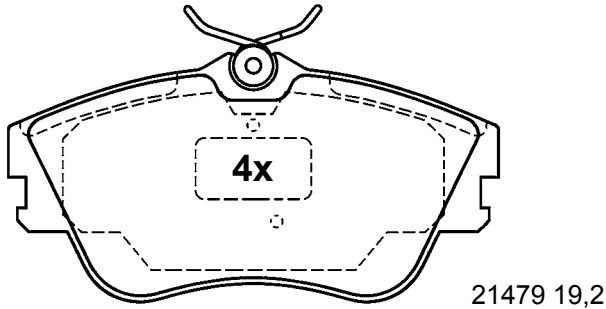

2x  
 M8x21 129,9 x 65,2 x 19,2

151,3 x 52,0 x 17,9

<b>B1.G102-0350.2 G1020350</b>	<b>B1.G102-0355.2 G1020355</b>
--------------------------------	--------------------------------

CITROEN, FIAT, PEUGEOT BDX

SEAT, VOLKSWAGEN ATE

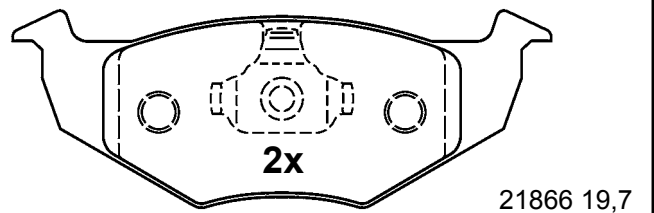
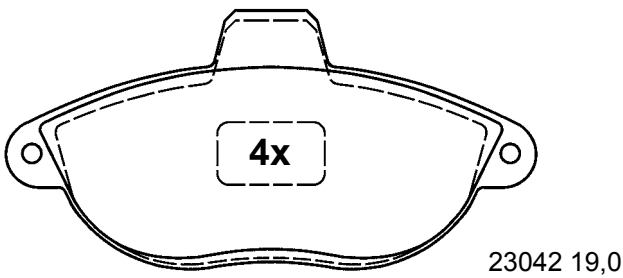

139,8 x 68,8 x 19,0

141,8 x 51,2 x 19,7

270mm 2x  
 2x 2x

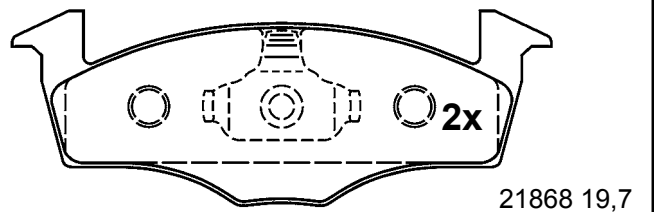

141,8 x 50,6 x 19,7

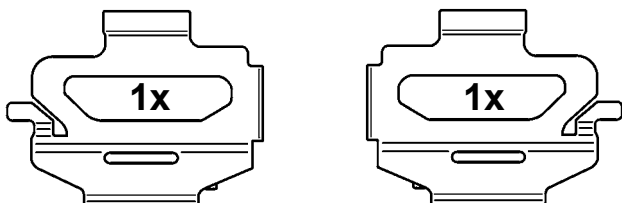



# Illustrations disc brake pads

Illustrations plaquettes de frein à disque / Illustrazioni pastiglie freno /  
 Figuras Calços do travão de disco / Rysunki okładzin hamulców tarczowych /  
 Zobrazení obložení kotoučových brzd

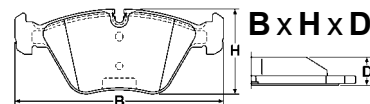

scale - échelle - scala - escala - skala - měřítko 1:2

## B1.G102-0357.2 G1020357



IVECO, RENAULT



BRE

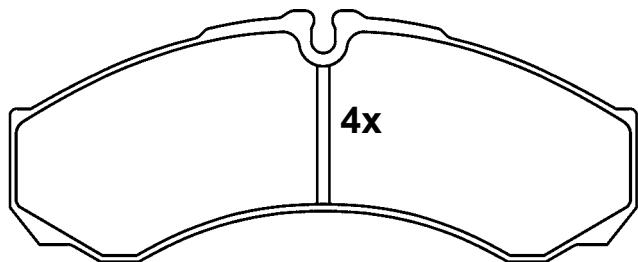

4x

29121 20,3

164,6 x 66,5 x 20,3

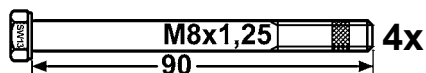

4x

## B1.G102-0360.2 G1020360



ALFA ROMEO, FIAT, LANCIA



ATE

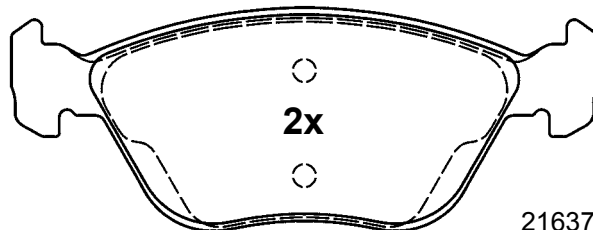

2x

21637 19,3

156,3 x 59,1 x 19,3

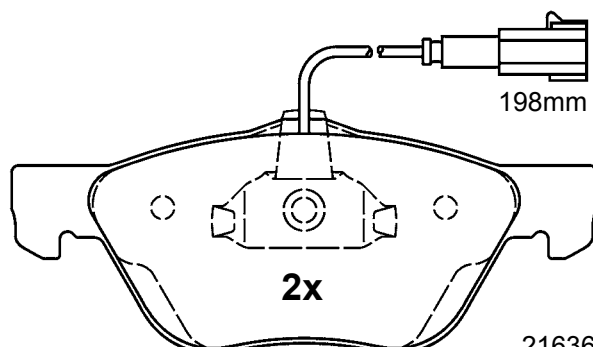

198mm

2x

21636 19,3

155,1 x 61,8 x 19,3

## B1.G102-0359.2 G1020359



ALFA ROMEO, LANCIA



LUC

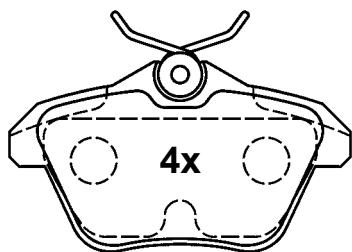

4x

21606 16,7



2x

M8x21

89,8 x 49,9 x 16,7

## B1.G102-0362.2 G1020362



PEUGEOT



LUC

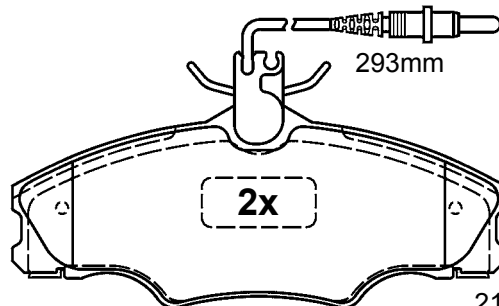

293mm

2x

21724 19,3

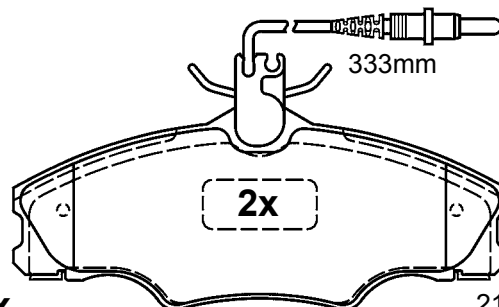

333mm

2x

21749 19,3



2x

M8x21

130,0 x 52,8 x 19,3

# Illustrations disc brake pads

Illustrations plaquettes de frein à disque / Illustrazioni pastiglie freno /  
Figuras Calços do travão de disco / Rysunki okładzin hamulców tarczowych /  
Zobrazení obložení kotoučových brzd

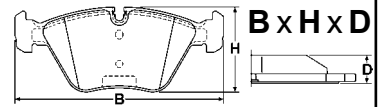

scale - échelle - scala - escala - skala - měřítko 1:2

## B1.G102-0363.2 G1020363



CITROEN, PEUGEOT



LUC

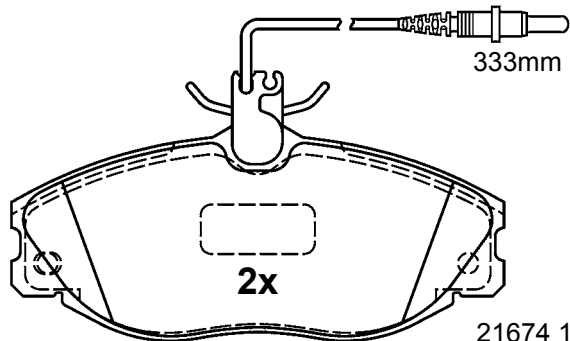

21674 19,0

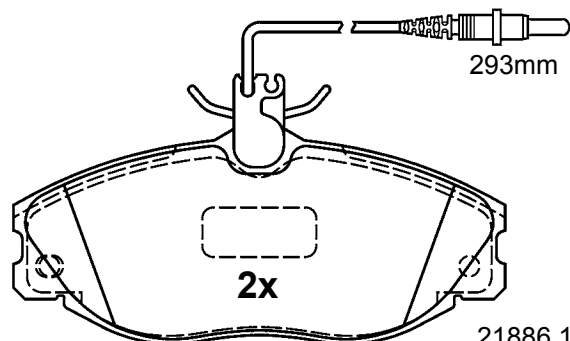

21886 19,0



129,9 x 56,4 x 19,0

## B1.G102-0368.2 G1020368



BMW



ATE

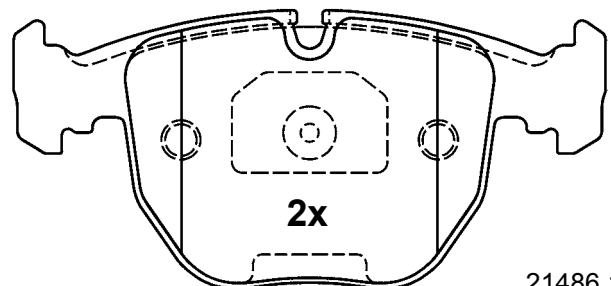

21486 19,3

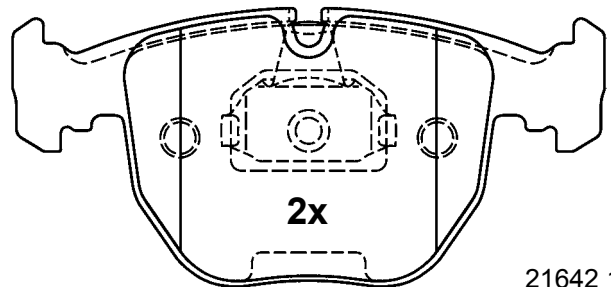

21642 19,3

156,3 x 73,2 x 19,3

## B1.G102-0367.2 G1020367



BMW, LAND ROVER



ATE

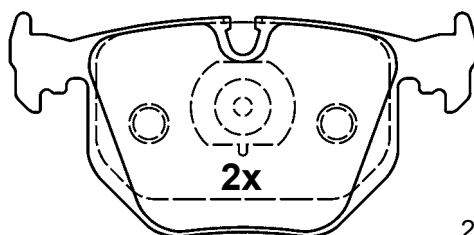

21282 17,3

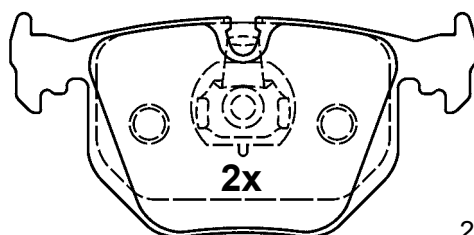

21487 17,3

123,0 x 59,2 x 17,3

## B1.G102-0369.2 G1020369



OPEL, SAAB, VAUXHALL



ATE

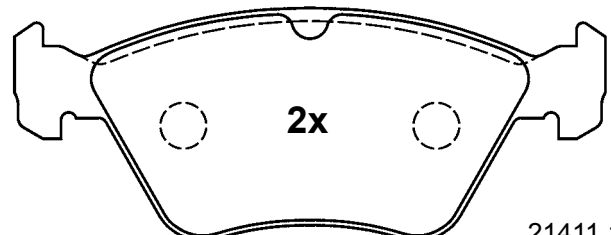

21411 17,5

156,3 x 60,7 x 17,5

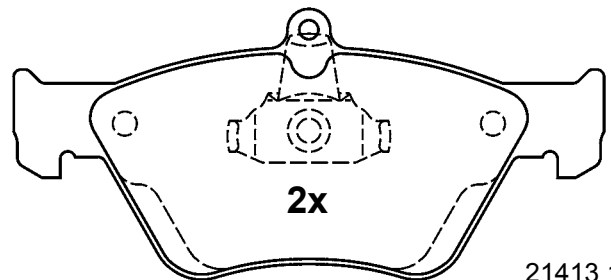

21413 18,3

155,1 x 70,6 x 18,3

# Illustrations disc brake pads

Illustrations plaquettes de frein à disque / Illustrazioni pastiglie freno /  
Figuras Calços do travão de disco / Rysunki okładzin hamulców tarczowych /  
Zobrazení obložení kotoučových brzd

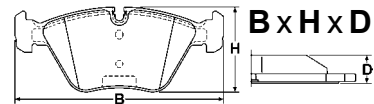

scale - échelle - scala - escala - skala - měřítko 1:2

<b>B1.G102-0373.2 G1020373</b>	<b>B1.G102-0384.2 G1020384</b>
--------------------------------	--------------------------------

**PEUGEOT**

21278 16,4

21279 16,4

**63,7 x 57,8 x 16,4**

**ALFA ROMEO, FIAT, LANCIA**

23177 14,2

**87,0 x 44,6 x 14,2**

**B1.G102-0379.2 G1020379**

**AUDI, SEAT, SKODA, VOLKSWAGEN**

20676 19,8

**156,3 x 74,0 x 19,8**

21911 20,3

**156,3 x 74,0 x 20,3**

**B1.G102-0389.2 G1020389**

**FIAT**

23218 18,0

23220 18,0

(23220) 18,0







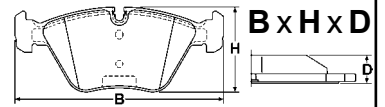

**151,3 x 49,2 x 18,0**

# Illustrations disc brake pads

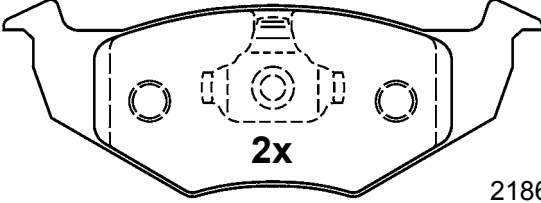
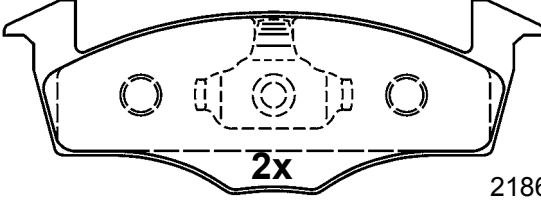
Illustrations plaquettes de frein à disque / Illustrazioni pastiglie freno /  
Figuras Calços do travão de disco / Rysunki okładzin hamulców tarczowych /  
Zobrazení obložení kotoučových brzd

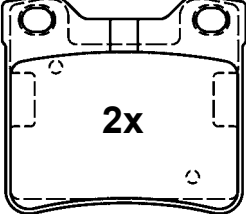
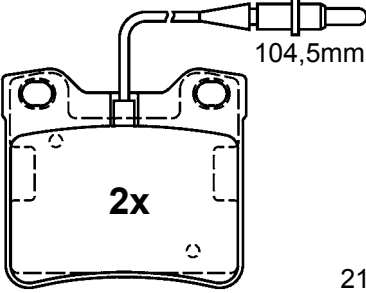

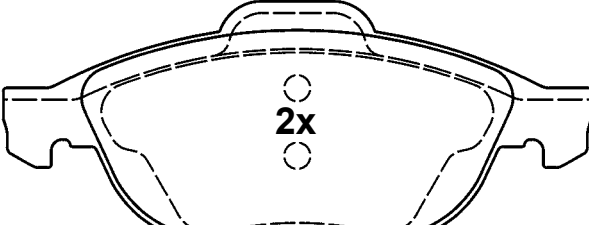
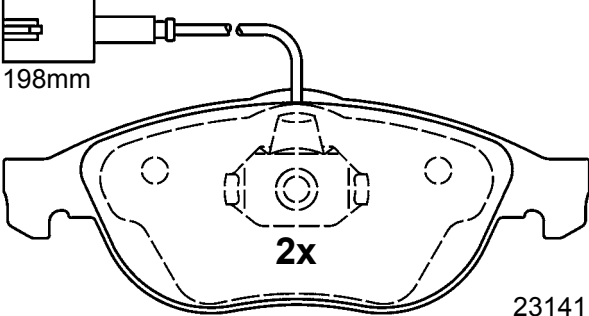
scale - échelle - scala - escala - skala - měřítko 1:2

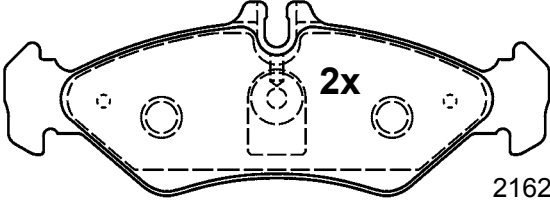
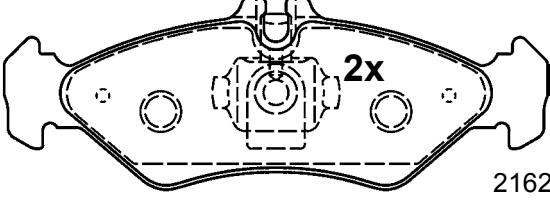
B1.G102-0390.2 G1020390	B1.G102-0395.2 G1020395
<p> SEAT, VOLKSWAGEN </p>  <p><b>2x</b></p> <p>21866 15,3</p> <p>141,8 x 51,2 x 15,3</p>  <p><b>2x</b></p> <p>21868 15,3</p> <p>141,8 x 50,6 x 15,3</p>	<p> MERCEDES BENZ </p>  <p><b>2x</b></p> <p>21278 16,9</p>  <p>104,5mm</p> <p><b>2x</b></p> <p>21904 16,9</p> <p>63,7 x 57,4 x 16,9</p>
B1.G102-0392.2 G1020392	B1.G102-0396.2 G1020396
<p> ALFA ROMEO, LANCIA </p>  <p><b>2x</b></p> <p>23140 19,4</p> <p>156,3 x 63,8 x 19,4</p>  <p>198mm</p> <p><b>2x</b></p> <p>23141 19,4</p> <p>155,1 x 59,3 x 19,4</p>	<p> MERCEDES BENZ, VOLKSWAGEN </p>  <p><b>2x</b></p> <p>21621 17,3</p>  <p><b>2x</b></p> <p>21622 17,3</p> <p>141,3 x 49,9 x 17,3</p>

# Illustrations disc brake pads

Illustrations plaquettes de frein à disque / Illustrazioni pastiglie freno /  
Figuras Calços do travão de disco / Rysunki okładzin hamulców tarczowych /  
Zobrazení obložení kotoučových brzd

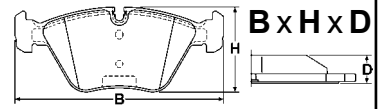

scale - échelle - scala - escala - skala - měřítko 1:2

## B1.G102-0397.2 G1020397



MERCEDES BENZ,  
VOLKSWAGEN



ATE

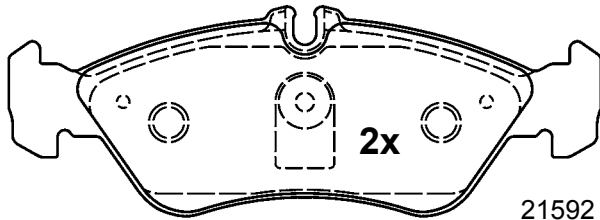

21592 18,8

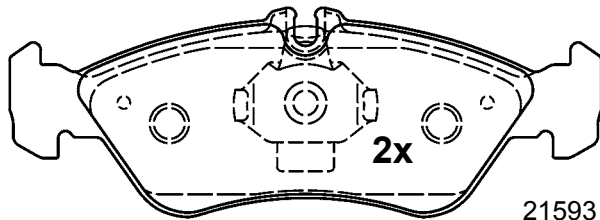

21593 18,8

156,3 x 54,8 x 18,8

## B1.G102-0400.2 G1020400



CHRYSLER, MERCEDES BENZ



ATE

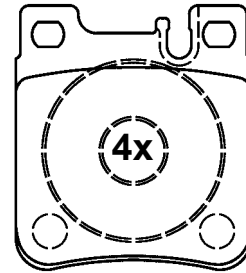

21305 15,7

61,7 x 69,5 x 15,7

## B1.G102-0398.2 G1020398



MERCEDES BENZ



ATE

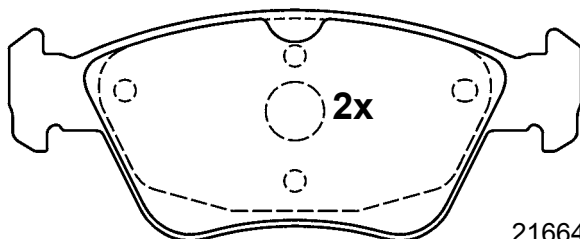

21664 19,8

151,3 x 59,8 x 19,8

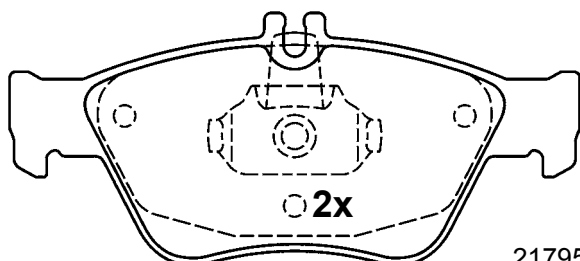

21795 19,8

150,1 x 66,2 x 19,8

## B1.G102-0401.2 G1020401



CHRYSLER, MERCEDES BENZ



ATE

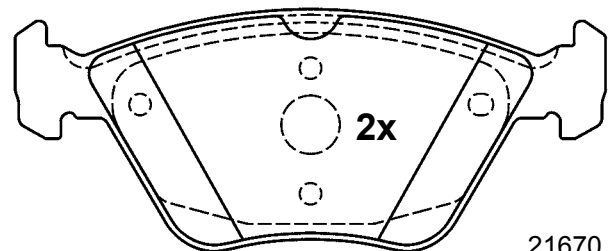

21670 19,4

156,3 x 63,5 x 19,4

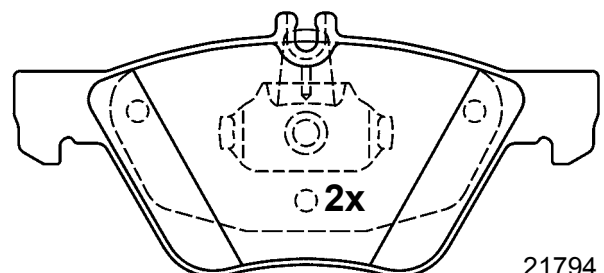

21794 19,4

155,1 x 69,3 x 19,4

# Illustrations disc brake pads

Illustrations plaquettes de frein à disque / Illustrazioni pastiglie freno /  
Figuras Calços do travão de disco / Rysunki okładzin hamulców tarczowych /  
Zobrazení obložení kotoučových brzd

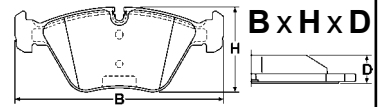

scale - échelle - scala - escala - skala - měřítko 1:2

## B1.G102-0403.2 G1020403

OPEL, SAAB, VAUXHALL

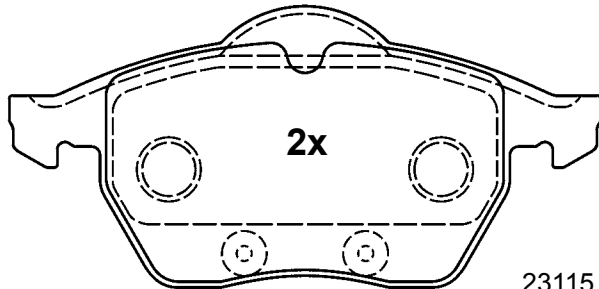

156,3 x 74,0 x 19,8

23115 19,8

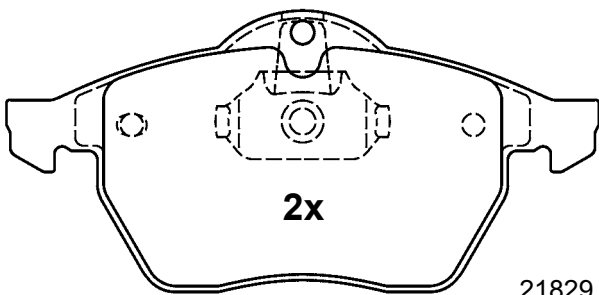

155,1 x 74,0 x 20,3

21829 20,3

## B1.G102-0409.2 G1020409

SKODA, VOLKSWAGEN

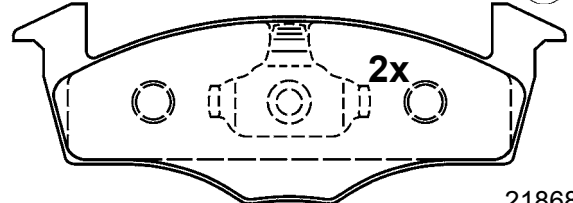

141,8 x 50,6 x 17,2

21868 17,2

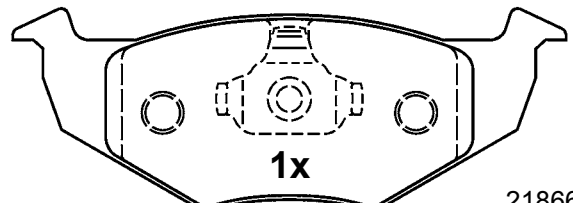

141,8 x 51,2 x 17,2

21866 17,2

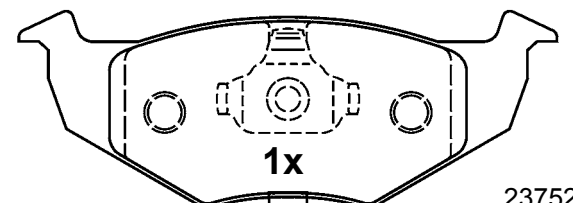

141,8 x 51,2 x 17,2

23752 17,2

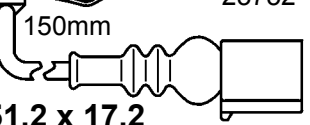

## B1.G102-0408.2 G1020408

SEAT, SKODA, VOLKSWAGEN

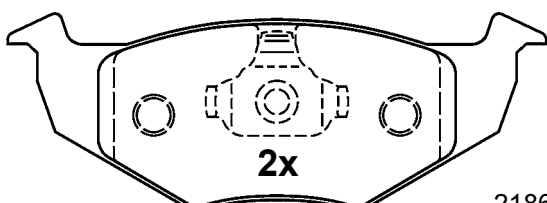

141,8 x 51,2 x 17,2

21866 17,2

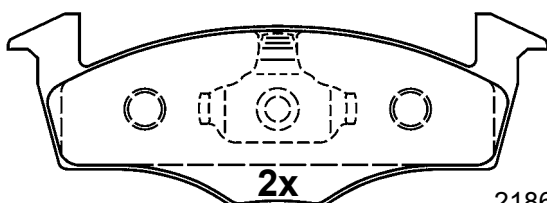

141,8 x 50,6 x 17,2

21868 17,2

## B1.G102-0411.2 G1020411

BMW

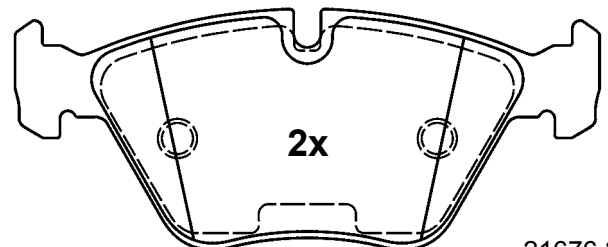

154,6 x 63,5 x 20,3

21676 20,3

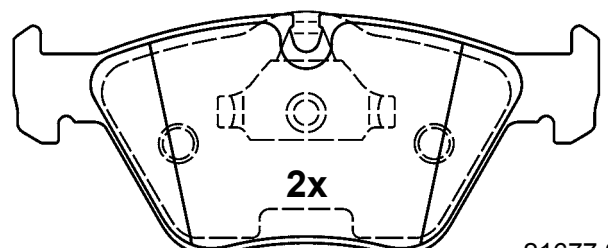

155,1 x 63,5 x 20,3

21677 20,3

# Illustrations disc brake pads

Illustrations plaquettes de frein à disque / Illustrazioni pastiglie freno /  
 Figuras Calços do travão de disco / Rysunki okładzin hamulców tarczowych /  
 Zobrazení obložení kotoučových brzd

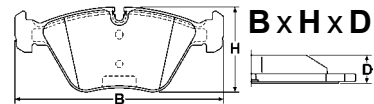

scale - échelle - scala - escala - skala - měřítko 1:2

<b>B1.G102-0415.2 G1020415</b>	<b>B1.G102-0421.2 G1020421</b>
--------------------------------	--------------------------------

**BMW**  **ATE**

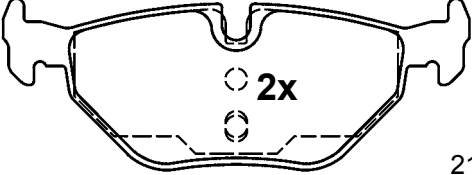

**2x**

21891 17,1

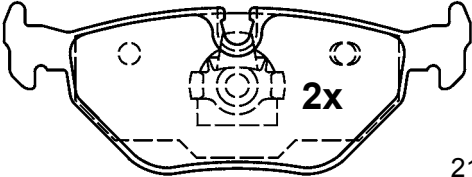

**2x**

21691 17,1

**123,0 x 44,9 x 17,1**

**AUDI, VOLKSWAGEN**  **LUC**

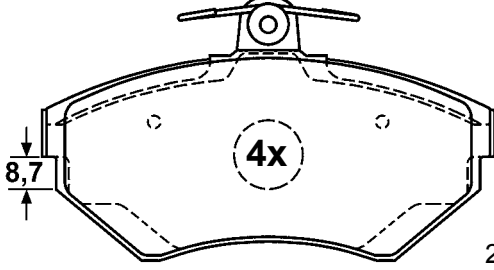

**4x**

21945 19,6

**119,1 x 69,5 x 19,6**



**2x**  
M8x21

**B1.G102-0419.2 G1020419**

**VOLKSWAGEN**  **ATE**

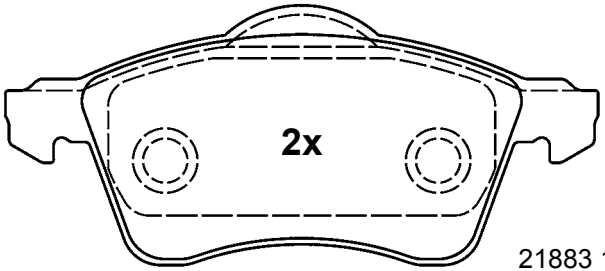

**2x**

21883 19,8

**156,3 x 68,5 x 19,8**

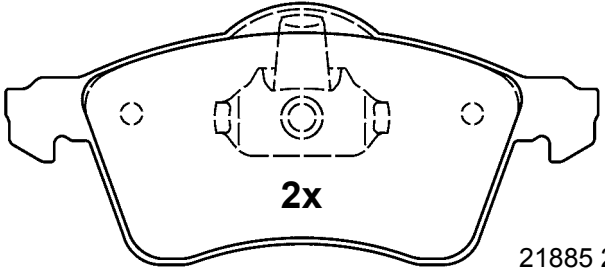

**2x**

21885 20,4

**156,3 x 68,5 x 20,4**

**B1.G102-0422.2 G1020422**

**MERCEDES BENZ**  **ATE**

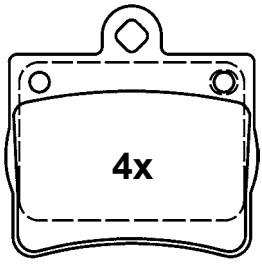

**4x**

21900 15,0

**63,7 x 63,2 x 15,0**

# Illustrations disc brake pads

Illustrations plaquettes de frein à disque / Illustrazioni pastiglie freno /  
 Figuras Calços do travão de disco / Rysunki okładzin hamulców tarczowych /  
 Zobrazení obložení kotoučových brzd

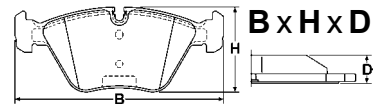

scale - échelle - scala - escala - skala - měřítko 1:2

<b>B1.G102-0423.2 G1020423</b>	<b>B1.G102-0440.2 G1020440</b>
--------------------------------	--------------------------------

**FORD** **BDX**

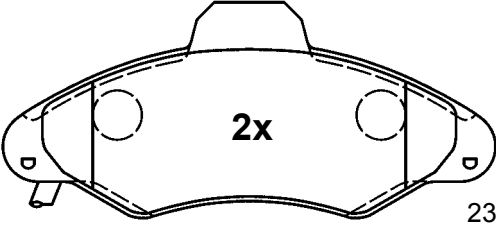

**2x**

23300 18,0

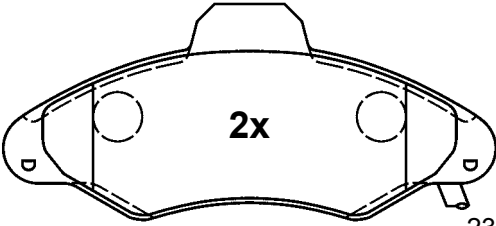

**2x**

23301 18,0

**130,8 x 57,3 x 18,0**

**MERCEDES BENZ** **LUC**

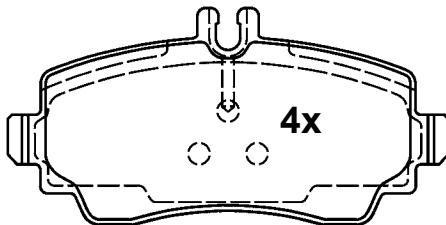

**4x**

23070 16,9

**116,5 x 57,1 x 16,9**

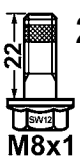

**2x**

M8x1

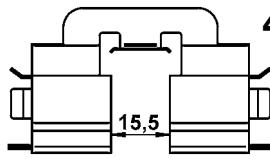

**4x**

15,5

<b>B1.G102-0427.2 G1020427</b>	<b>B1.G102-0441.2 G1020441</b>
--------------------------------	--------------------------------

**FIAT** **ATE**

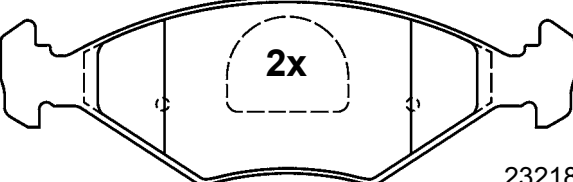

**2x**

23218 18,0

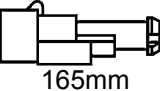

165mm

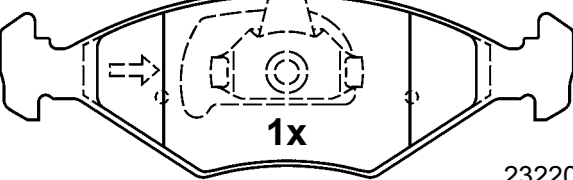

**1x**

23220 18,0

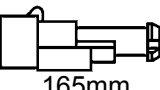

165mm

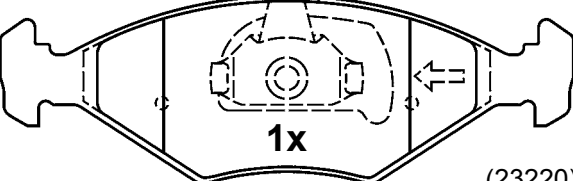

**1x**

(23220) 18,0

**151,3 x 49,2 x 18,0**

**CHRYSLER, MERCEDES BENZ** **ATE**

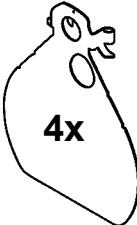

**4x**

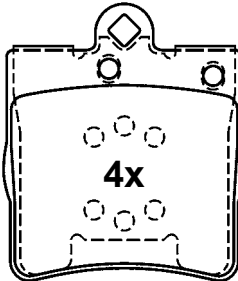

**4x**

21919 15,3

**63,8 x 72,8 x 15,3**









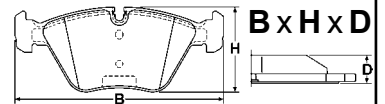



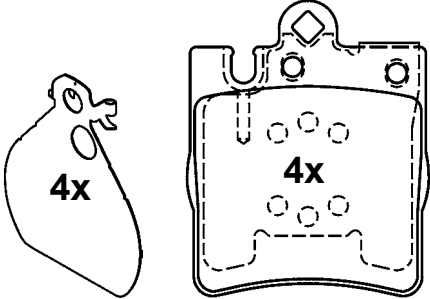

# Illustrations disc brake pads

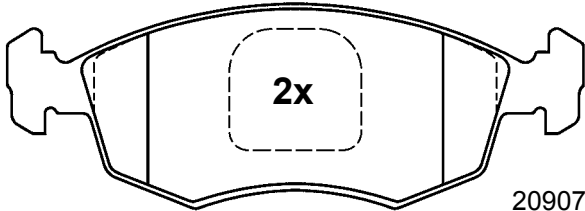
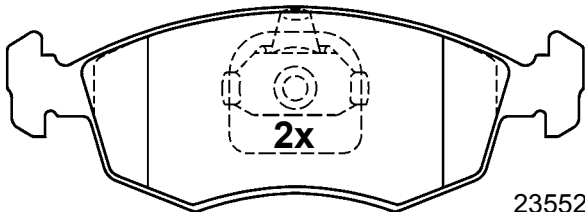
Illustrations plaquettes de frein à disque / Illustrazioni pastiglie freno /  
Figuras Calços do travão de disco / Rysunki okładzin hamulców tarczowych /  
Zobrazení obložení kotoučových brzd

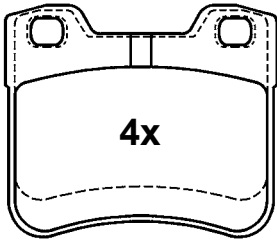

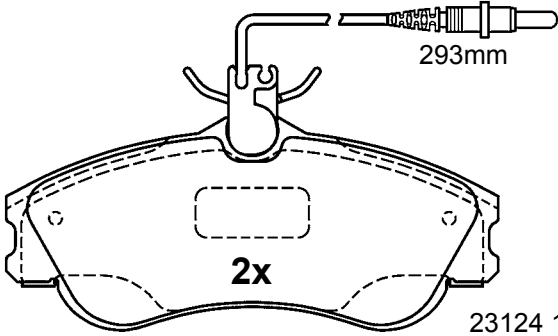
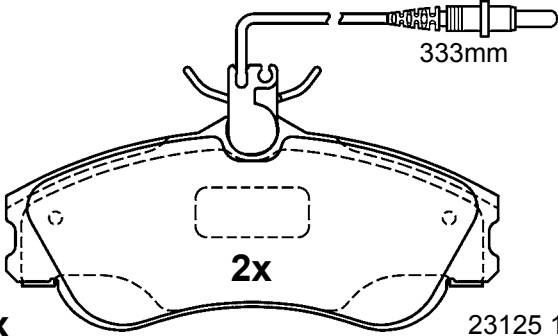
scale - échelle - scala - escala - skala - měřítko 1:2

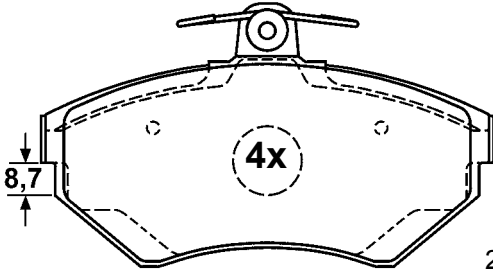
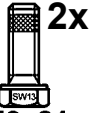
B1.G102-0442.2 G1020442	B1.G102-0448.2 G1020448
<p> MERCEDES BENZ  ATE</p>  <p>21899 15,3</p> <p>63,7 x 78,0 x 15,3</p>	<p> FIAT  ATE</p>  <p>20907 18,1</p>  <p>23552 18,1</p> <p>151,3 x 52,5 x 18,1</p>
B1.G102-0443.2 G1020443	B1.G102-0451.2 G1020451
<p> CITROEN, PEUGEOT  ATE</p>  <p>21857 17,7</p> <p>71,9 x 60,6 x 17,7</p>	<p> CITROEN, PEUGEOT  LUC</p>  <p>23124 19,0</p>  <p>23125 19,0</p> <p>129,9 x 56,2 x 19,0</p>
B1.G102-0444.2 G1020444	
<p> SEAT, VOLKSWAGEN  LUC</p>  <p>21945 16,0</p>  <p>M8x21</p> <p>119,1 x 69,5 x 16,0</p>	

# Illustrations disc brake pads

Illustrations plaquettes de frein à disque / Illustrazioni pastiglie freno /  
 Figuras Calços do travão de disco / Rysunki okładzin hamulców tarczowych /  
 Zobrazení obložení kotoučových brzd

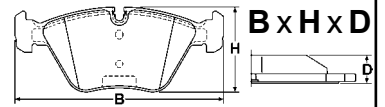

scale - échelle - scala - escala - skala - měřítko 1:2

## B1.G102-0457.2 G1020457



MITSUBISHI, VOLVO



LUC

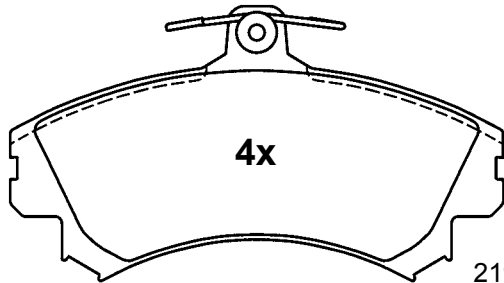

21920 14,6

129,9 x 72,7 x 14,6

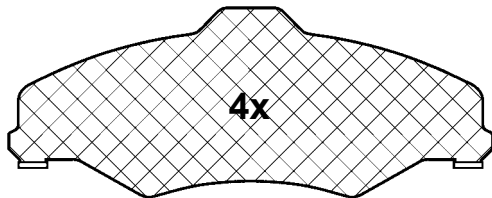

## B1.G102-0458.2 G1020458



MITSUBISHI, VOLVO



LUC

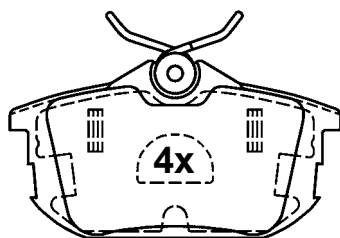

21861 15,2

87,0 x 47,0 x 15,2

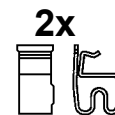

## B1.G102-0459.2 G1020459



RENAULT



LUC

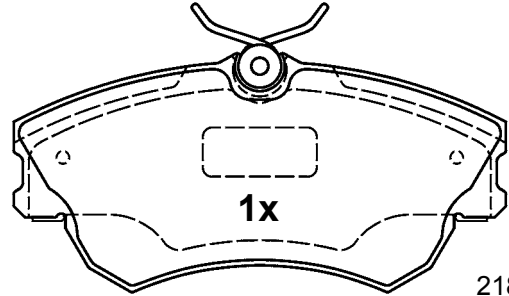

21888 18,1

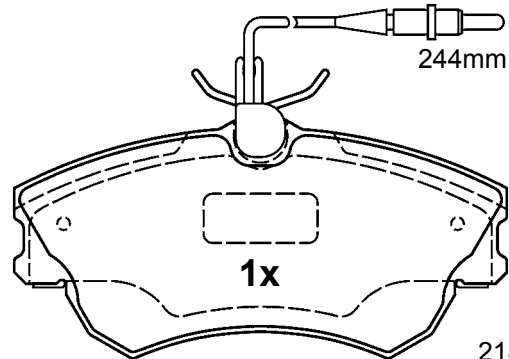

21889 18,1

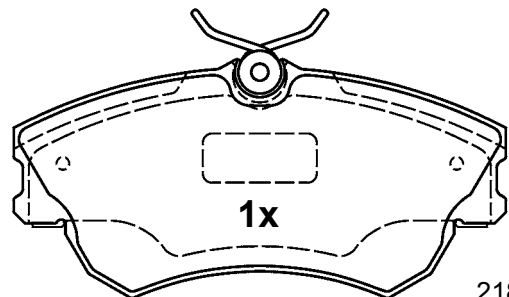

21888 18,1

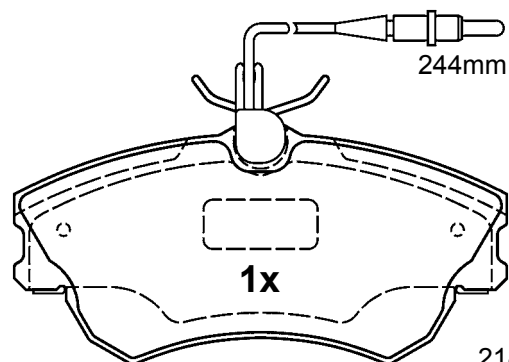

21889 18,1



129,8 x 63,0 x 18,1

# Illustrations disc brake pads

Illustrations plaquettes de frein à disque / Illustrazioni pastiglie freno /  
Figuras Calços do travão de disco / Rysunki okładzin hamulców tarczowych /  
Zobrazení obložení kotoučových brzd

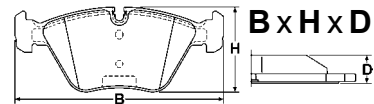

scale - échelle - scala - escala - skala - měřítko 1:2

## B1.G102-0463.2 G1020463



AUDI, SEAT, SKODA, VW



VW

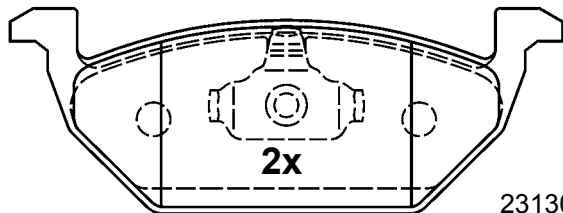

23130 19,7

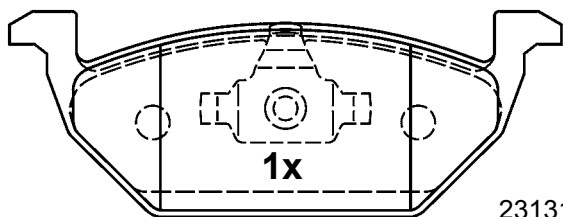

23131 19,7

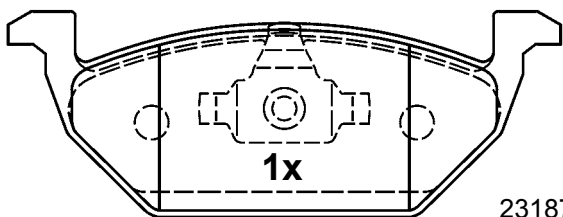

23187 19,7

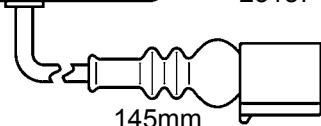

145mm

146,0 x 54,7 x 19,7

## B1.G102-0469.2 G1020469



FIAT



ATE

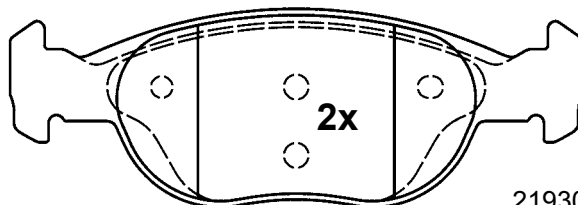

21930 17,9

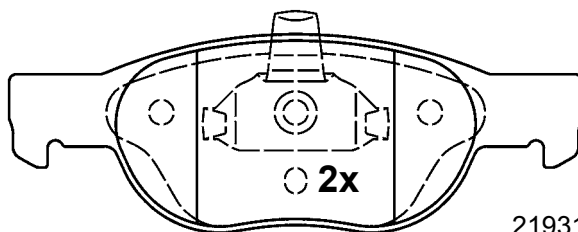

21931 17,9

151,3 x 52,0 x 17,9

## B1.G102-0470.2 G1020470



FORD, NISSAN, RENAULT



ATE

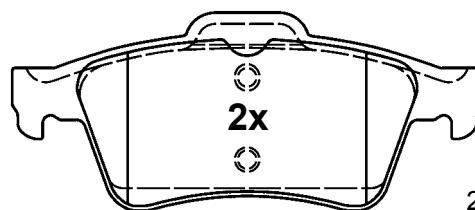

23482 15,8

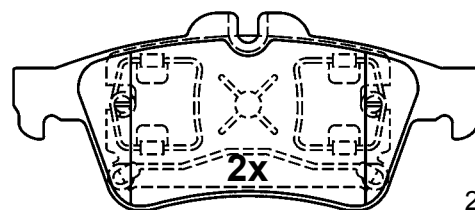

23483 15,8

123,0 x 51,9 x 15,8

## B1.G102-0467.2 G1020467



FORD, MAZDA



ATE

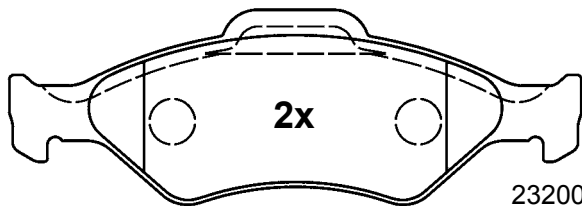

23200 18,0

151,3 x 51,3 x 18,0

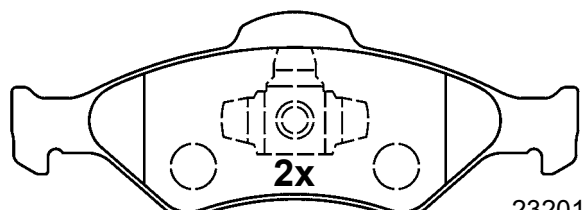

23201 18,0

150,1 x 54,1 x 18,0

# Illustrations disc brake pads

Illustrations plaquettes de frein à disque / Illustrazioni pastiglie freno /

Figuras Calços do travão de disco / Rysunki okładzin hamulców tarczowych /

Zobrazení obložení kotoučových brzd

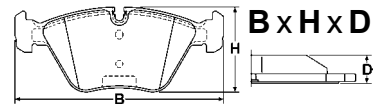

scale - échelle - scala - escala - skala - měřítko 1:2

## B1.G102-0473.2 G1020473



ALFA ROMEO, FIAT, LANCIA



ATE

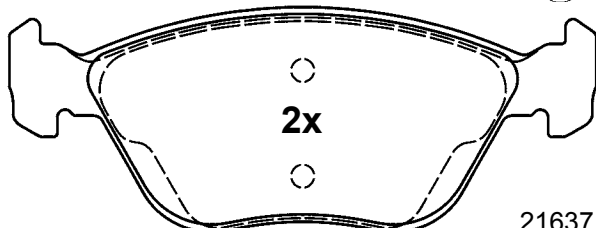

2x

21637 19,3

156,3 x 59,1 x 19,3

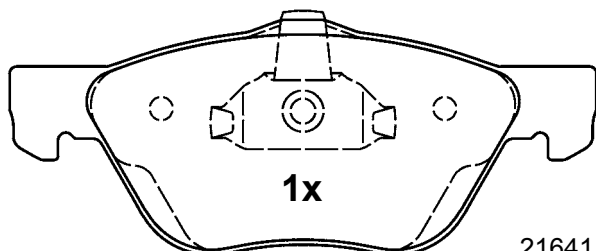

1x

21641 19,3

155,1 x 61,8 x 19,3

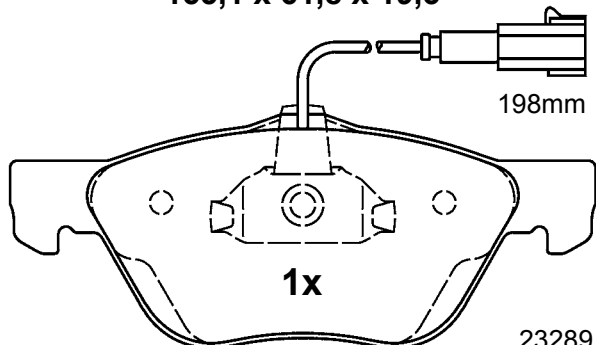

198mm

1x

23289 19,3

155,1 x 61,8 x 19,3

## B1.G102-0478.2 G1020478



TOYOTA



BOS

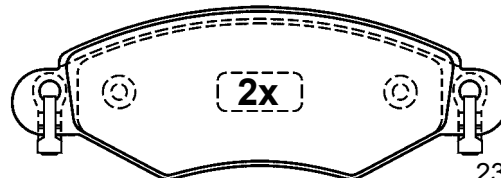

2x

23342 17,0

130,7 x 45,0 x 17,0

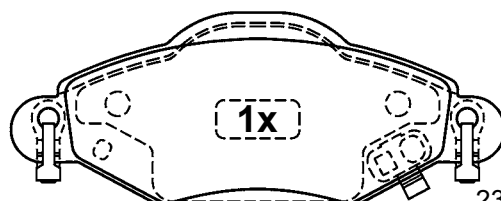

1x

23340 17,0

130,7 x 51,0 x 17,0

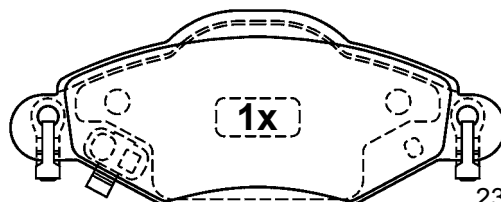

1x

23341 17,0

130,7 x 51,0 x 17,0

## B1.G102-0474.2 G1020474



BMW



ATE

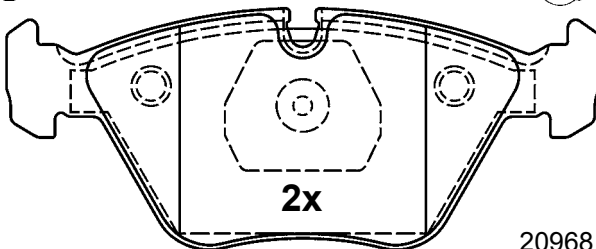

2x

20968 20,3

156,3 x 63,5 x 20,3

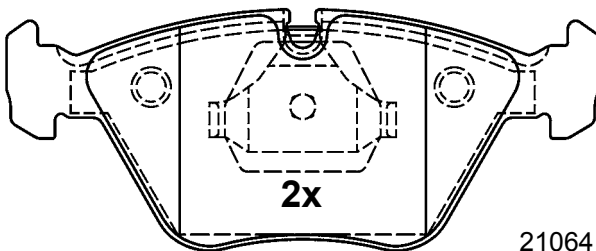

2x

21064 20,3

## B1.G102-0480.2 G1020480



VOLVO



ATE

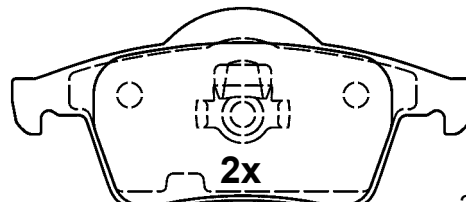

2x

23076 17,5

122,4 x 53,7 x 17,5

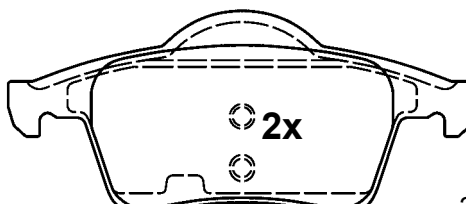

2x

23077 17,5

123,6 x 53,7 x 17,5

# Illustrations disc brake pads

Illustrations plaquettes de frein à disque / Illustrazioni pastiglie freno /  
 Figuras Calços do travão de disco / Rysunki okładzin hamulców tarczowych /  
 Zobrazení obložení kotoučových brzd

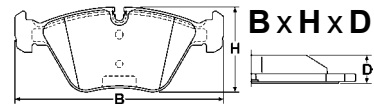

scale - échelle - scala - escala - skala - měřítko 1:2

## B1.G102-0482.2 G1020482



CITROEN, FIAT, PEUGEOT



LUC

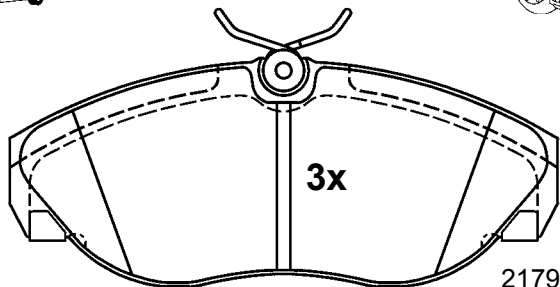

3x

21797 19,7

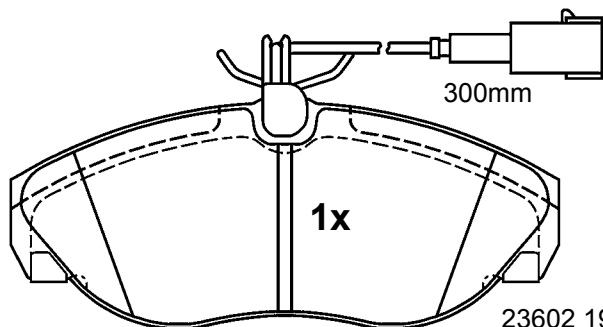

300mm

1x

23602 19,7

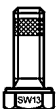

2x

M8x21

144,8 x 60,8 x 19,7

## B1.G102-0484.2 G1020484



FIAT



ATE

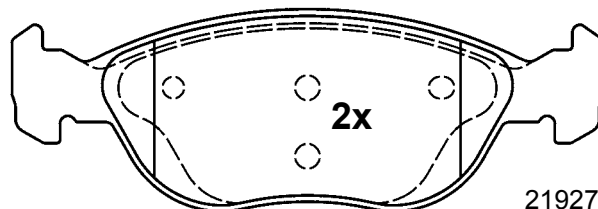

2x

21927 17,9

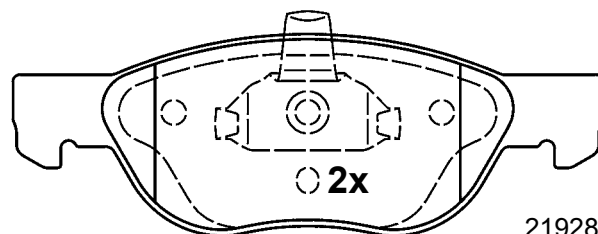

2x

21928 17,9

156,3 x 52,7 x 17,9

## B1.G102-0483.2 G1020483



CITROEN, FIAT, PEUGEOT



LUC

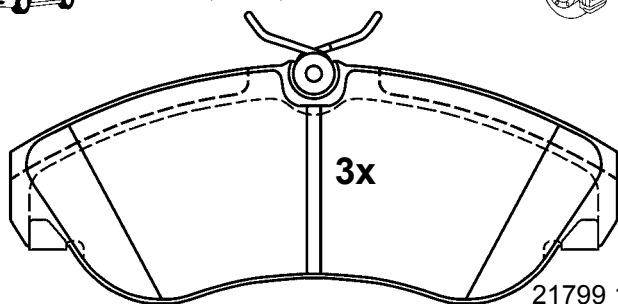

3x

21799 19,7

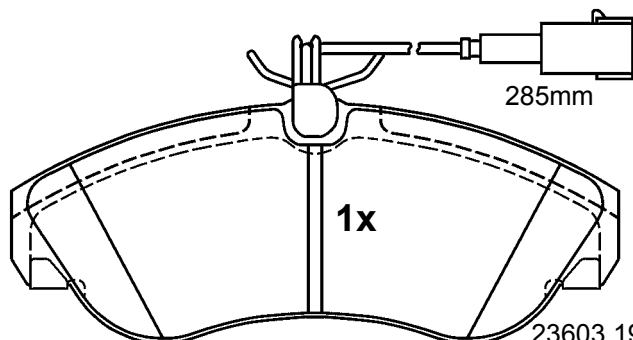

285mm

1x

23603 19,7

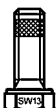

2x

M8x21

159,8 x 64,1 x 19,7

## B1.G102-0487.2 G1020487



PEUGEOT



ATE

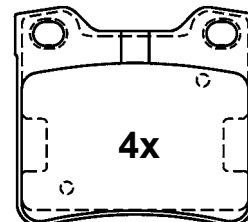

4x

21278 16,4

63,7 x 57,8 x 16,4

# Illustrations disc brake pads

Illustrations plaquettes de frein à disque / Illustrazioni pastiglie freno /  
Figuras Calços do travão de disco / Rysunki okładzin hamulców tarczowych /  
Zobrazení obložení kotoučových brzd

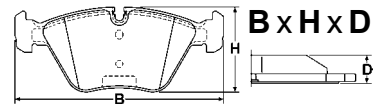

scale - échelle - scala - escala - skala - měřítko 1:2

## B1.G102-0489.2 G1020489



RENAULT



LUC

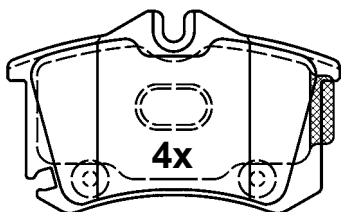

23554 16,3

87,2 x 52,9 x 16,3

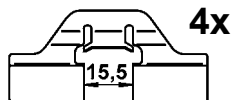
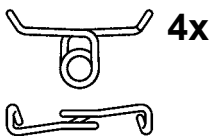
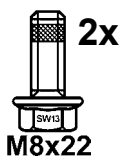

## B1.G102-0496.2 G1020496



FIAT



ATE

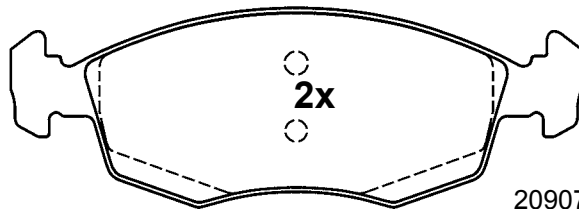

20907 18,1

151,3 x 52,5 x 18,1

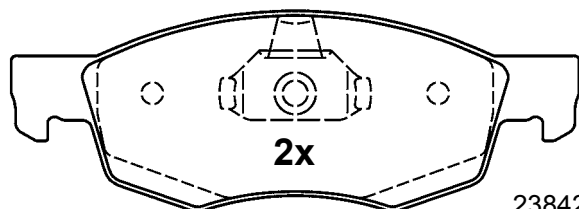

23842 18,1

150,1 x 52,5 x 18,1

## B1.G102-0492.2 G1020492



AUDI, CITROEN, PEUGEOT,  
SEAT, SKODA, VOLKSWAGEN



LUC

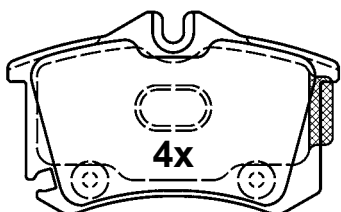

23554 17,1

87,2 x 52,9 x 17,1

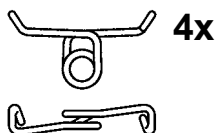

## B1.G102-0497.2 G1020497



CITROEN, NISSAN, RENAULT



BOS

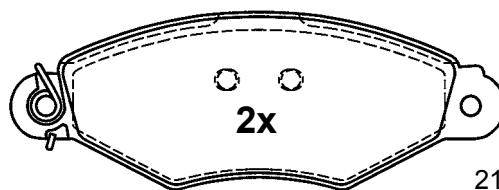

21980 18,0

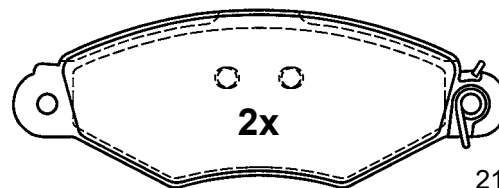

21981 18,0

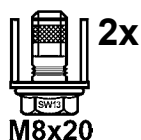

130,7 x 47,2 x 18,0

# Illustrations disc brake pads

Illustrations plaquettes de frein à disque / Illustrazioni pastiglie freno /  
 Figuras Calços do travão de disco / Rysunki okładzin hamulców tarczowych /  
 Zobrazení obložení kotoučových brzd

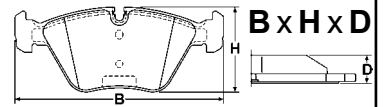

scale - échelle - scala - escala - skala - měřítko 1:2

<b>B1.G102-0500.2 G1020500</b>	<b>B1.G102-0501.2 G1020501</b>
--------------------------------	--------------------------------



ALFA ROMEO, LANCIA



ATE

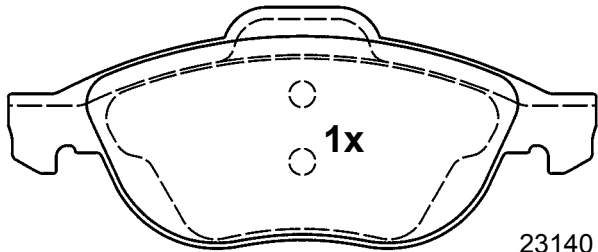

23140 19,4

156,3 x 63,8 x 19,4

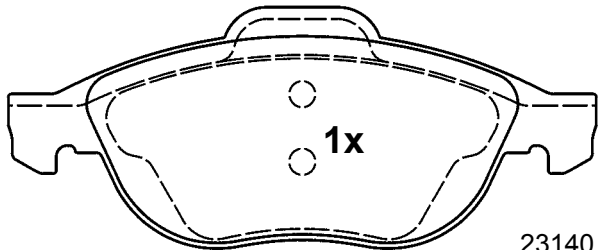

23140 19,4

156,3 x 63,8 x 19,4

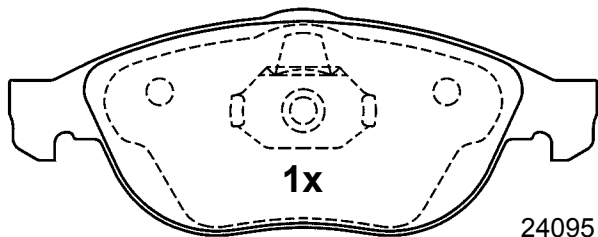

24095 19,4

155,1 x 59,3 x 19,4

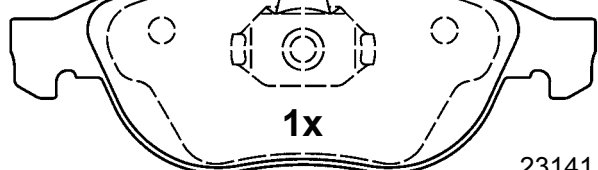
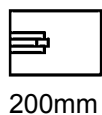

23141 19,4

155,1 x 59,3 x 19,4



DACIA, RENAULT



LUC

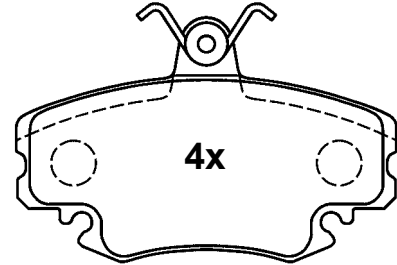

21463 18,2

99,9 x 64,8 x 18,2

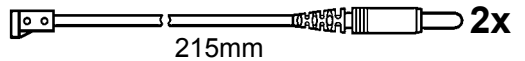

<b>B1.G102-0503.2</b>	<b>G1020503</b>
-----------------------	-----------------



FIAT, LANCIA



BOS

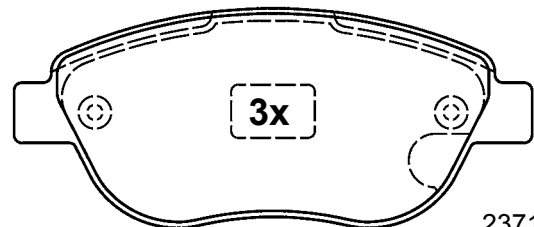

23710 19,0

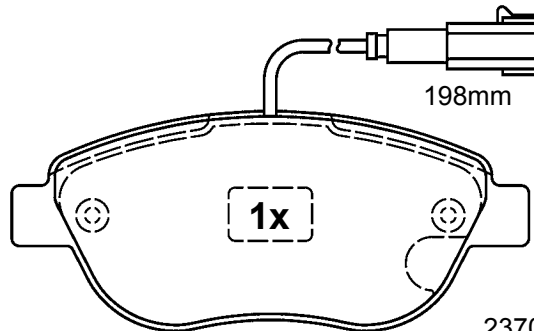

23709 19,0

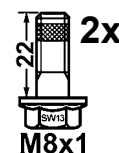

136,8 x 57,4 x 19,0

# Illustrations disc brake pads

Illustrations plaquettes de frein à disque / Illustrazioni pastiglie freno /  
 Figuras Calços do travão de disco / Rysunki okładzin hamulców tarczowych /  
 Zobrazení obložení kotoučových brzd

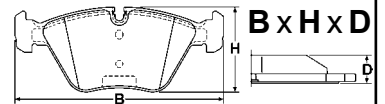

scale - échelle - scala - escala - skala - měřítko 1:2

## B1.G102-0504.2 G1020504

ALFA ROMEO, FIAT, LANCIA

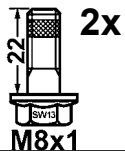
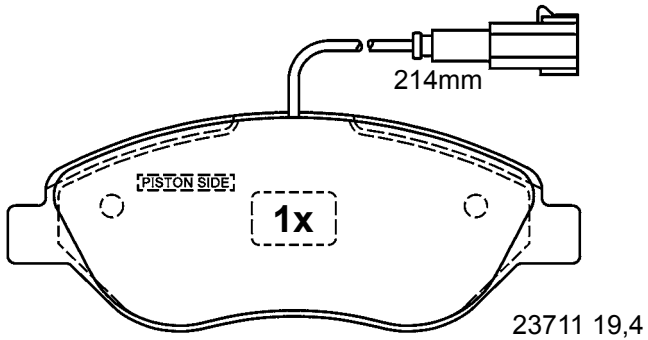
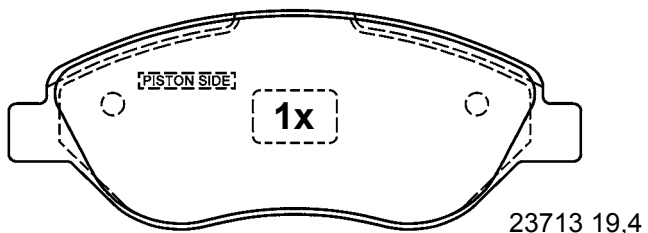
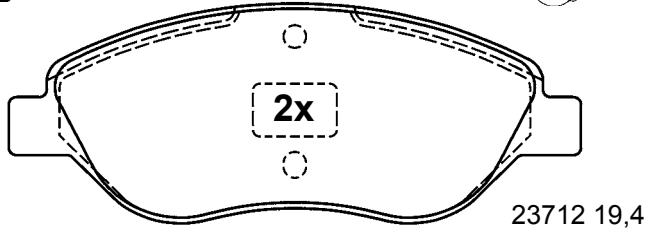

150,8 x 57,4 x 19,4

## B1.G102-0507.2 G1020507

FORD

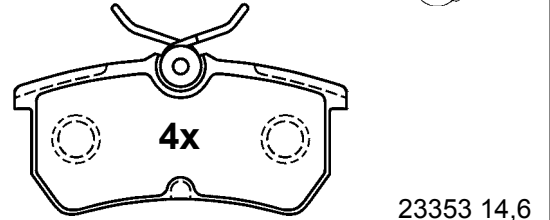

87,6 x 42,4 x 14,6

## B1.G102-0510.2 G1020510

VOLVO

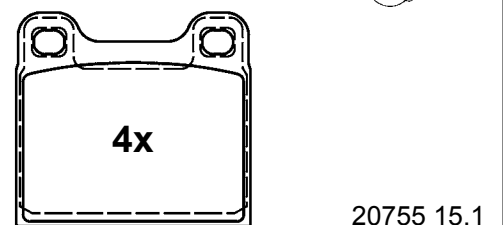

61,8 x 56,5 x 15,1

## B1.G102-0511.2 G1020511

AUDI, SEAT, VOLKSWAGEN

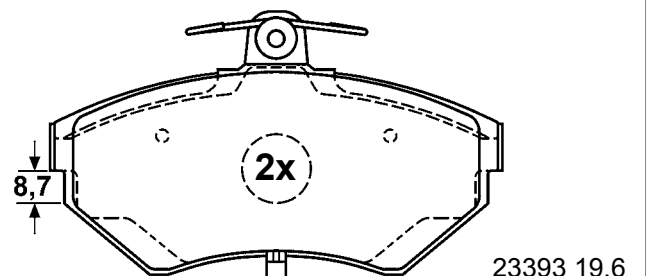
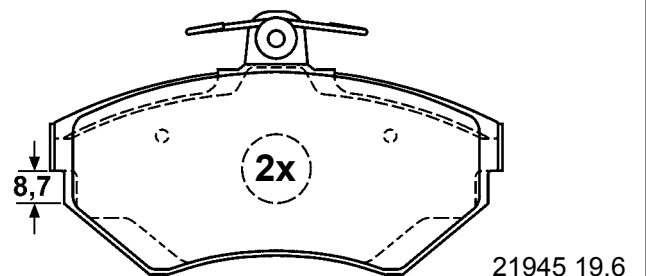

119,1 x 69,5 x 19,6

## B1.G102-0505.2 G1020505

FORD

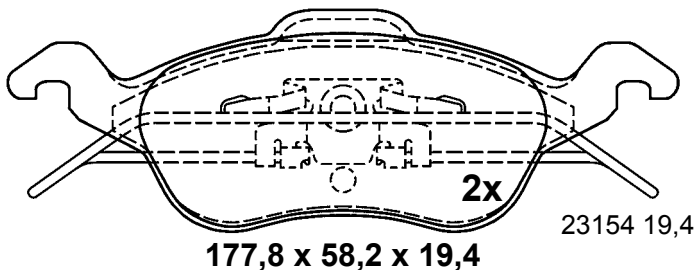

177,8 x 58,2 x 19,4

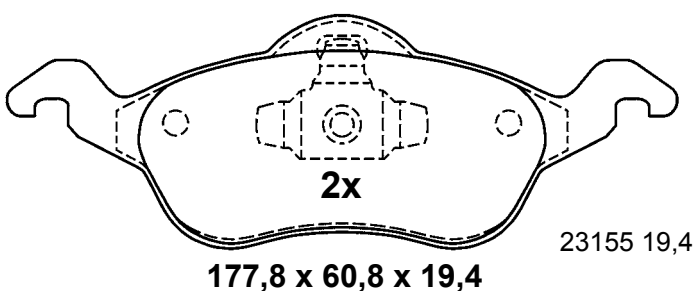

177,8 x 60,8 x 19,4



# Illustrations disc brake pads

Illustrations plaquettes de frein à disque / Illustrazioni pastiglie freno /  
 Figuras Calços do travão de disco / Rysunki okładzin hamulców tarczowych /  
 Zobrazení obložení kotoučových brzd

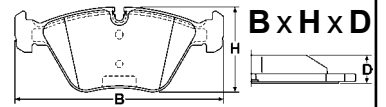

scale - échelle - scala - escala - skala - měřítko 1:2

## B1.G102-0512.2 G1020512



AUDI, SEAT, SKODA,  
VOLKSWAGEN



ATE

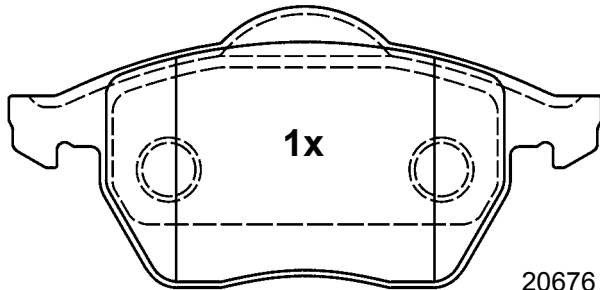

1x

20676 19,8

156,3 x 74,0 x 19,8

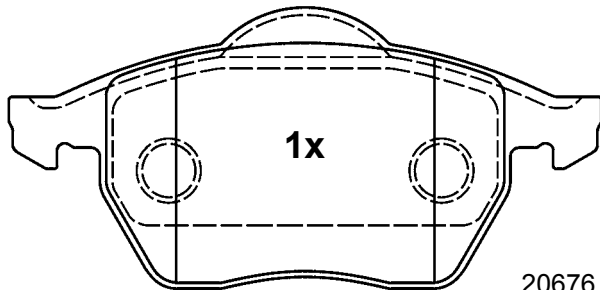

1x

20676 19,8

156,3 x 74,0 x 19,8

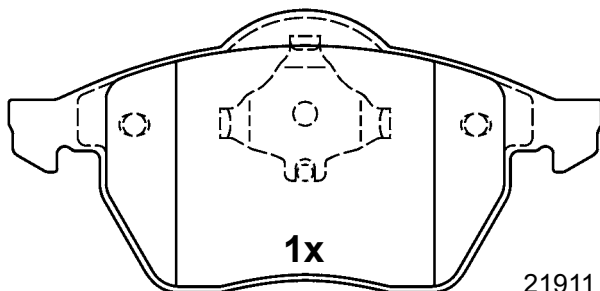

1x

21911 20,3

156,3 x 74,0 x 20,3

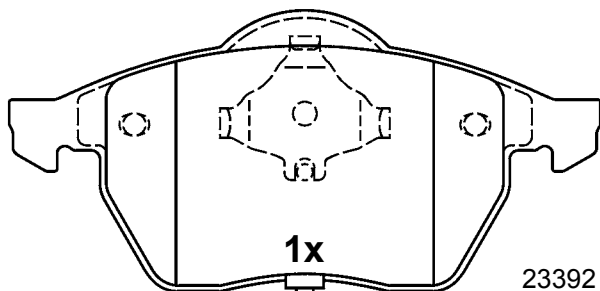

1x

23392 20,3

145mm

156,3 x 74,0 x 20,3

## B1.G102-0513.2 G1020513



CITROEN, PEUGEOT



BOS

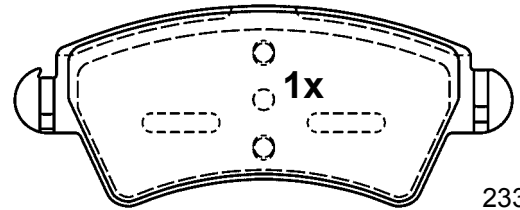

1x

23332 18,0

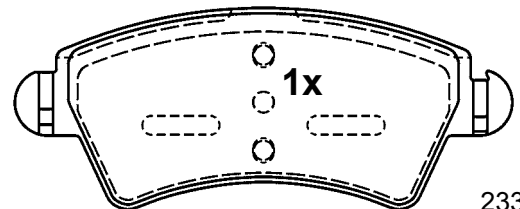

1x

23333 18,0

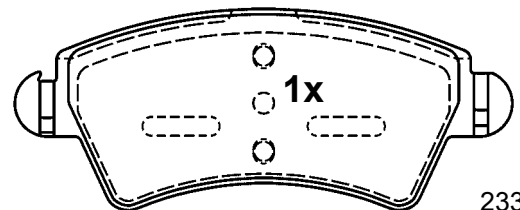

1x

23332 18,0

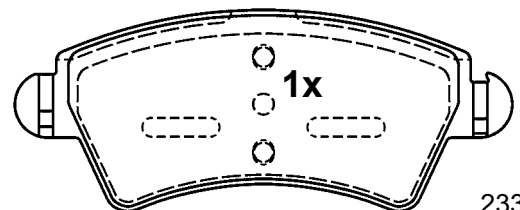

1x

23333 18,0

130,8 x 52,4 x 18,0

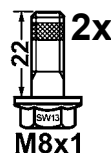

2x

M8x1



8x

# Illustrations disc brake pads

Illustrations plaquettes de frein à disque / Illustrazioni pastiglie freno /  
 Figuras Calços do travão de disco / Rysunki okładzin hamulców tarczowych /  
 Zobrazení obložení kotoučových brzd

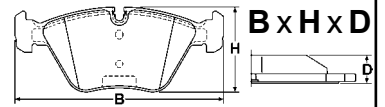

scale - échelle - scala - escala - skala - měřítko 1:2

## B1.G102-0514.2 G1020514      B1.G102-0516.2 G1020516

CITROEN, FIAT, LANCIA  
 PEUGEOT

CITROEN, FIAT, PEUGEOT

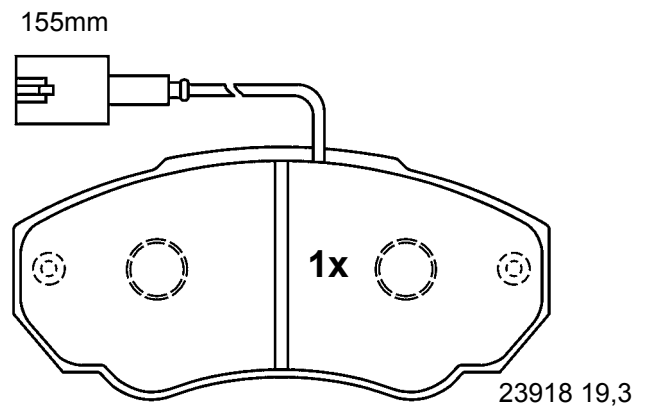
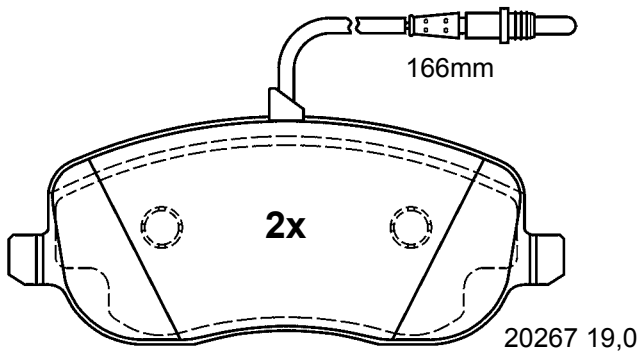
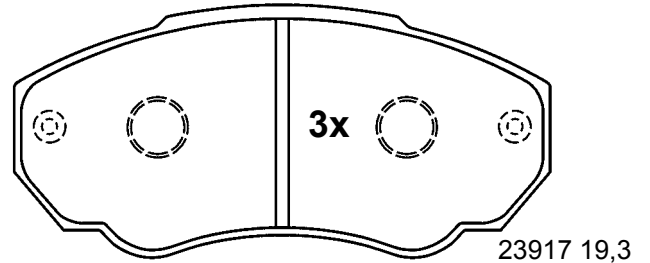
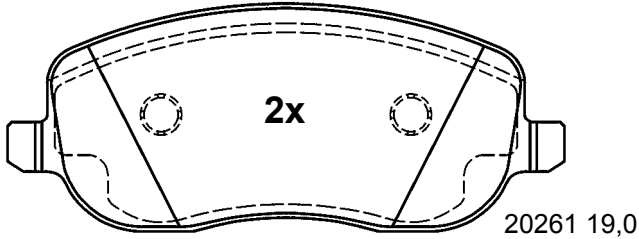

146,6 x 60,0 19,0

140,6 x 66,0 x 19,3

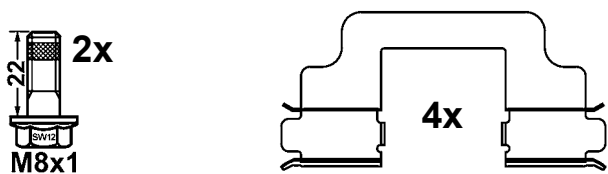

## B1.G102-0515.2 G1020515

ALFA ROMEO, FIAT, LANCIA

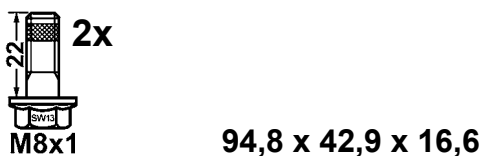
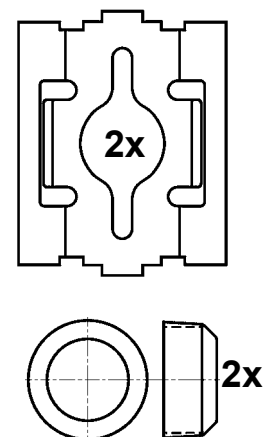
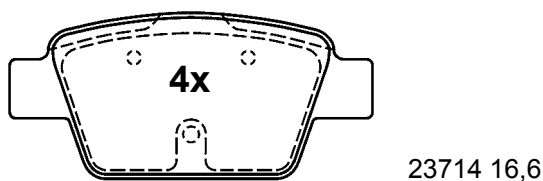

# Illustrations disc brake pads

Illustrations plaquettes de frein à disque / Illustrazioni pastiglie freno /  
 Figuras Calços do travão de disco / Rysunki okładzin hamulców tarczowych /  
 Zobrazení obložení kotoučových brzd

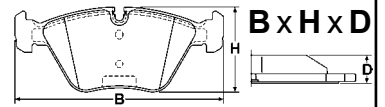

scale - échelle - scala - escala - skala - měřítko 1:2

## B1.G102-0517.2 G1020517



CITROEN, FIAT, PEUGEOT



BRE

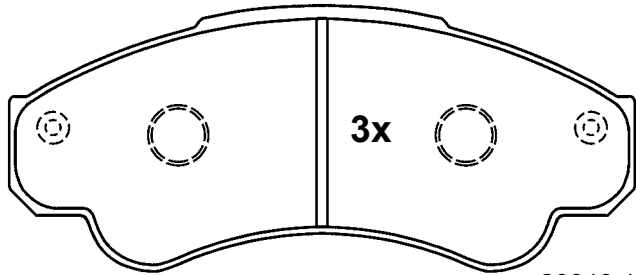

23919 19,3

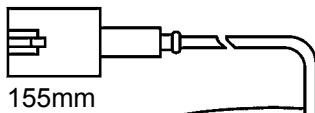

155mm

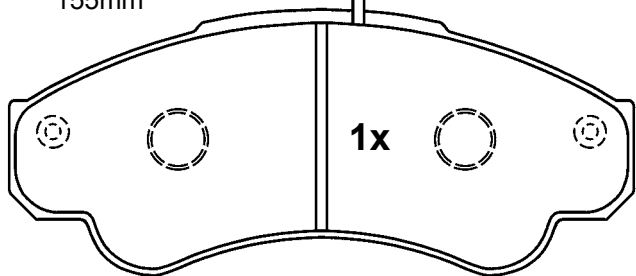

23920 19,3

164,6 x 69,3 x 19,3

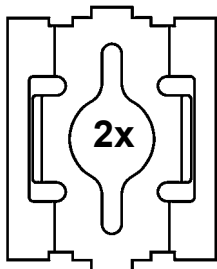

2x

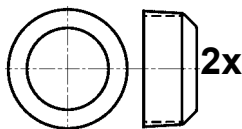

2x

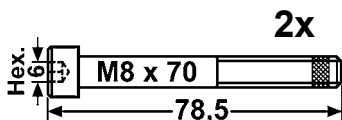

2x

78,5

## B1.G102-0518.2 G1020518



CITROEN, FIAT, PEUGEOT



BRE

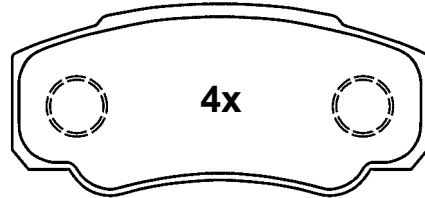

23921 20,3

109,6 x 50,0 x 20,3

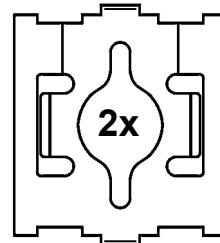

2x

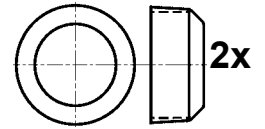

2x

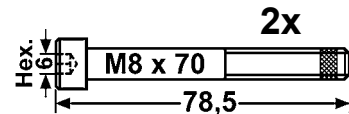

2x

M8 x 70

78,5

## B1.G102-0519.2 G1020519



FORD, MAZDA



ATE

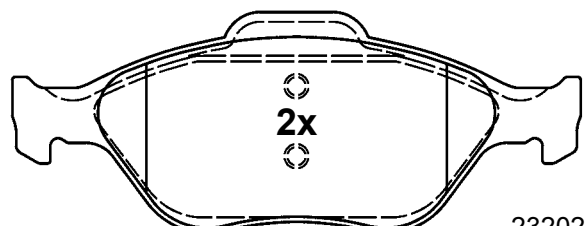

23202 17,8

151,3 x 58,2 x 17,8

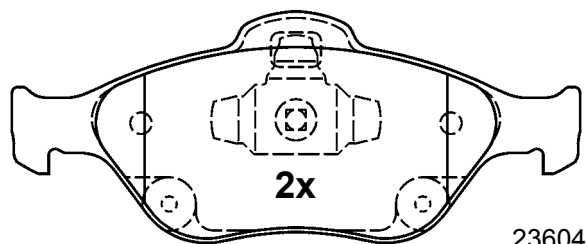

23604 17,8

150,1 x 61,0 x 17,8

# Illustrations disc brake pads

Illustrations plaquettes de frein à disque / Illustrazioni pastiglie freno /  
 Figuras Calços do travão de disco / Rysunki okładzin hamulców tarczowych /  
 Zobrazení obložení kotoučových brzd

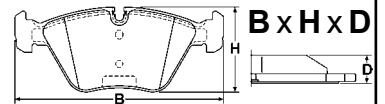

scale - échelle - scala - escala - skala - měřítko 1:2

<b>B1.G102-0522.2 G1020522</b>	<b>B1.G102-0527.2 G1020527</b>
--------------------------------	--------------------------------

CITROEN, PEUGEOT, RENAULT

VOLKSWAGEN

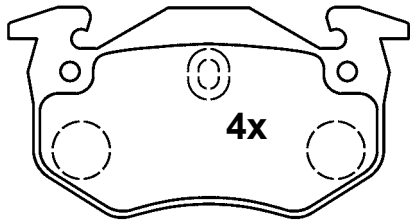

20974 10,7

105,0 x 54,8 x 10,7

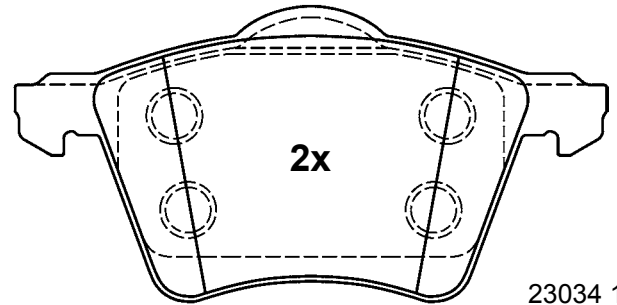

23034 18,8

156,3 x 78,5 x 18,8

<b>B1.G102-0524.2 G1020524</b>	
--------------------------------	--

VOLKSWAGEN

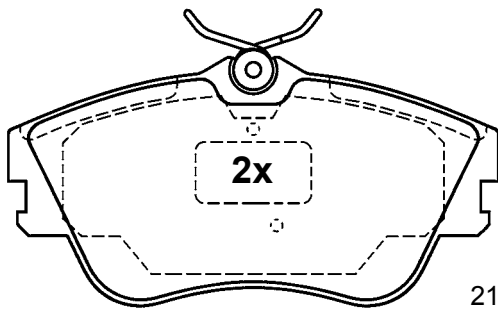

21479 19,2

2x

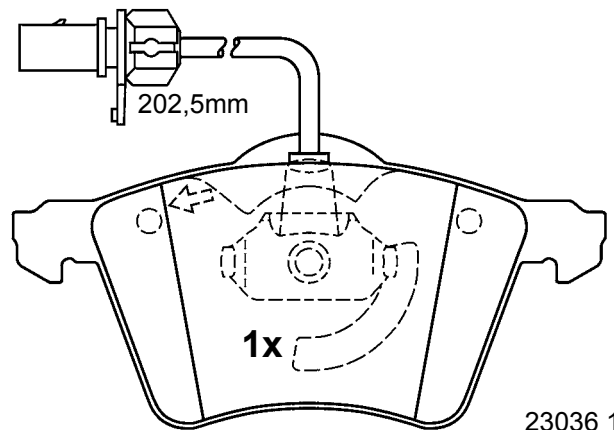

23036 19,4

156,3 x 78,5 x 19,4

1x

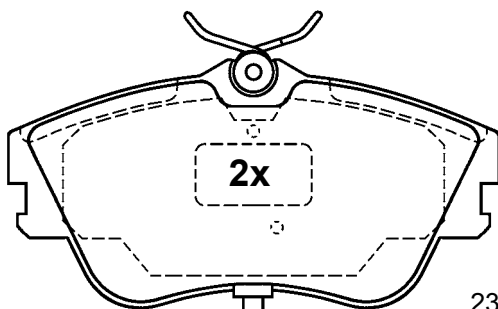

23445 19,2

2x

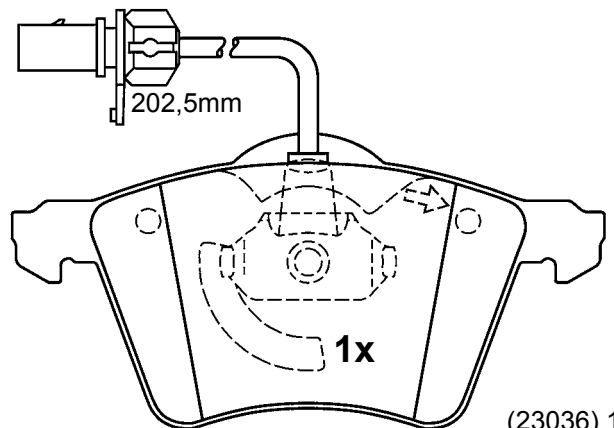

(23036) 19,4

156,3 x 78,5 x 19,4

1x



129,9 x 65,2 x 19,2



# Illustrations disc brake pads

Illustrations plaquettes de frein à disque / Illustrazioni pastiglie freno /  
 Figuras Calços do travão de disco / Rysunki okładzin hamulców tarczowych /  
 Zobrazení obložení kotoučových brzd

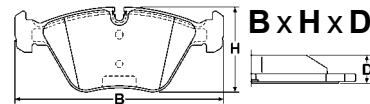

scale - échelle - scala - escala - skala - měřítko 1:2

<b>B1.G102-0529.2 G1020529</b>	<b>B1.G102-0534.2 G1020534</b>
--------------------------------	--------------------------------



NISSAN, OPEL, RENAULT  
VAUXHALL



LUC

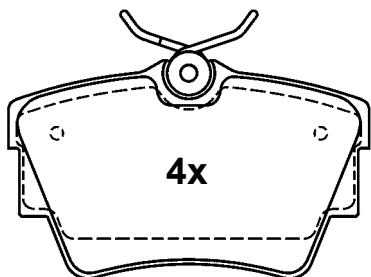

4x

23980 16,5



VOLKSWAGEN



ATE

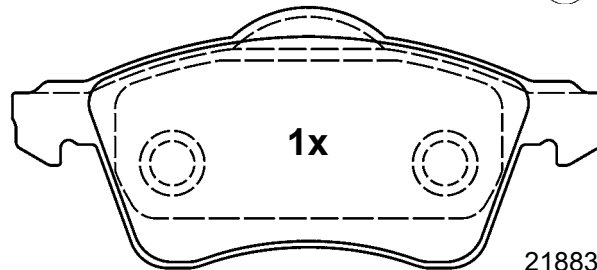

1x

21883 19,8

156,3 x 68,5 x 19,8



2x

M8x21

94,7 x 57,2 x 16,5

<b>B1.G102-0533.2 G1020533</b>	
--------------------------------	--



VOLKSWAGEN



LUC

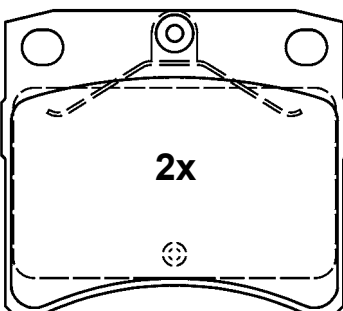

2x

91,5 x 80,0 x 18,3

20651 18,3

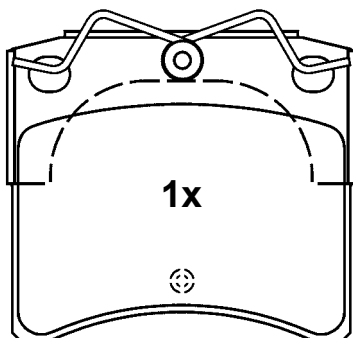

1x

91,7 x 80,0 x 18,7

21635 18,7

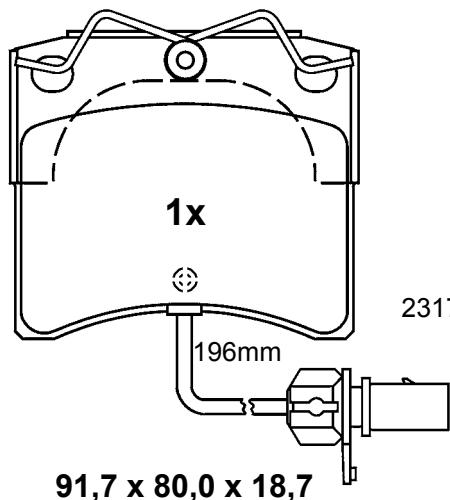

1x

23176 18,7

196mm

91,7 x 80,0 x 18,7

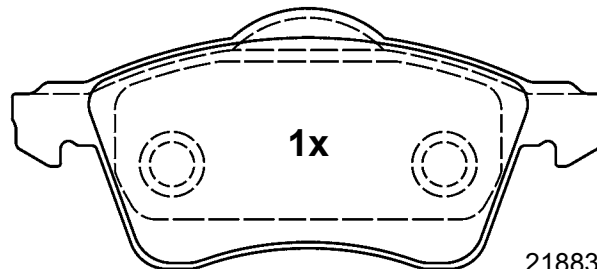

1x

21883 19,8

156,3 x 68,5 x 19,8

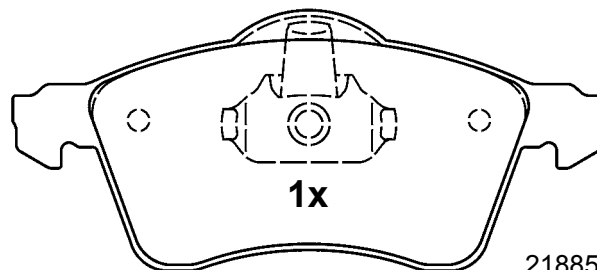

1x

21885 20,4

156,3 x 68,5 x 20,4

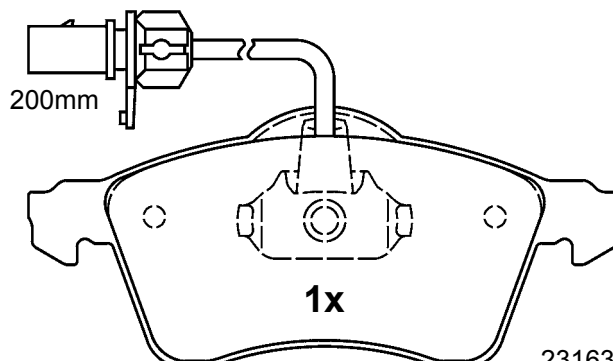

200mm

1x

23163 20,4







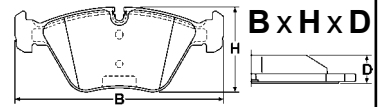

156,3 x 68,5 x 20,4

# Illustrations disc brake pads

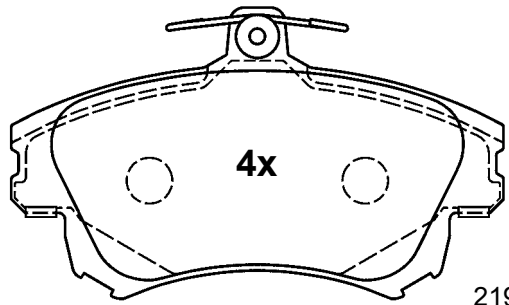
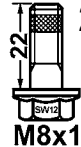
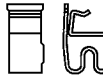
Illustrations plaquettes de frein à disque / Illustrazioni pastiglie freno /  
 Figuras Calços do travão de disco / Rysunki okładzin hamulców tarczowych /  
 Zobrazení obložení kotoučových brzd

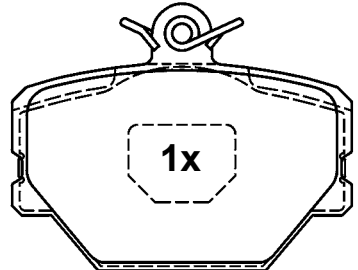
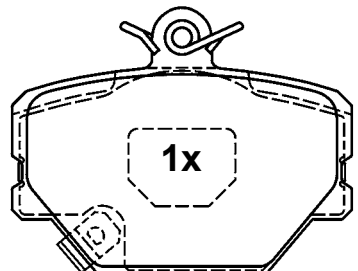

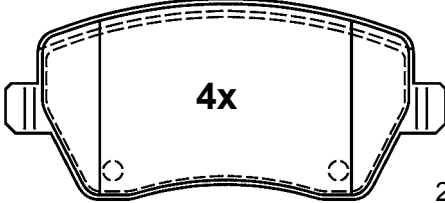
scale - échelle - scala - escala - skala - měřítko 1:2

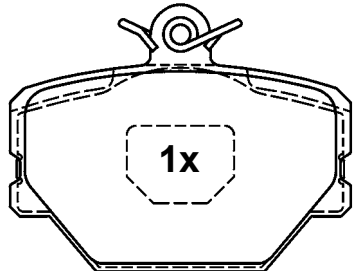
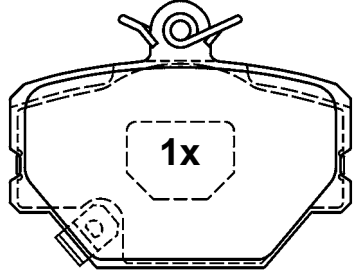
B1.G102-0537.2 G1020537	B1.G102-0540.2 G1020540
<p> MITSUBISHI, SMART, VOLVO  LUC</p>  <p>4x</p> <p>21983 17,2</p> <p>129,9 x 76,7 x 17,2</p> <p> 2x M8x1</p> <p> 2x</p>	<p> SMART  BOS</p>  <p>1x</p> <p>21999 15,8</p>  <p>1x</p> <p>23001 15,8</p>
B1.G102-0538.2 G1020538	
<p> NISSAN  LUC</p>  <p>4x</p> <p>23973 17,2</p> <p> 2x M8x21</p> <p>116,3 x 52,4 x 17,2</p>	 <p>1x</p> <p>21999 15,8</p>  <p>1x</p> <p>23001 15,8</p> <p>90,0 x 70,1 x 15,8</p>



# Illustrations disc brake pads

Illustrations plaquettes de frein à disque / Illustrazioni pastiglie freno /  
Figuras Calços do travão de disco / Rysunki okładzin hamulców tarczowych /  
Zobrazení obložení kotoučových brzd

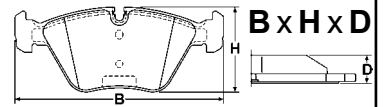

scale - échelle - scala - escala - skala - měřítko 1:2

## B1.G102-0542.2 G1020542



OPEL, VAUXHALL



ATE

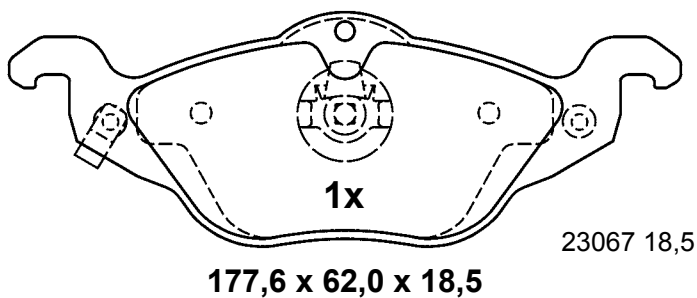
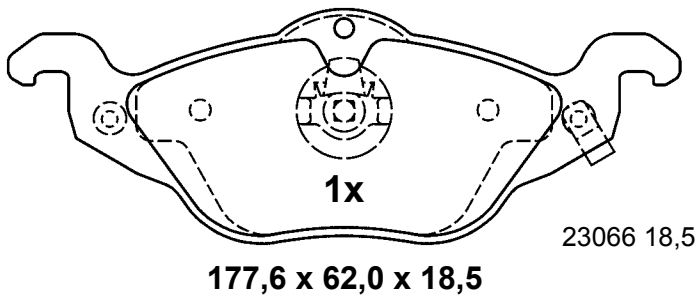
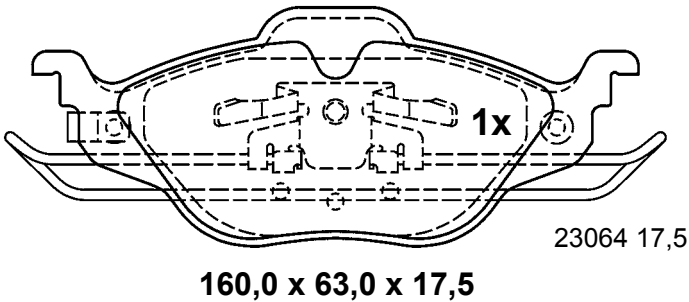
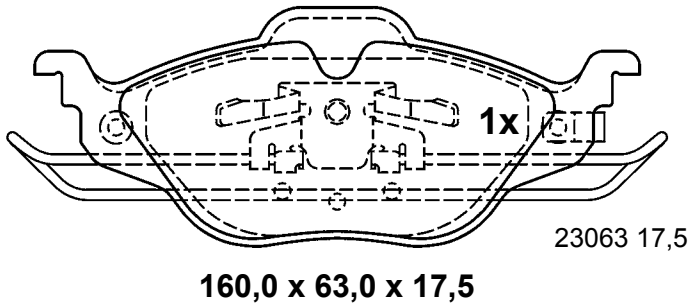

## B1.G102-0544.2 G1020544



MERCEDES BENZ



LUC

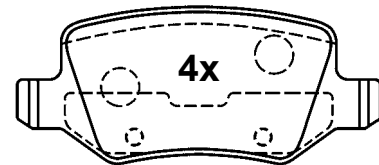

**95,6 x 41,3 x 14,6**

## B1.G102-0545.2 G1020545



OPEL, VAUXHALL



LUC

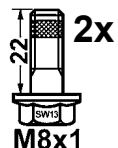
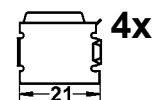
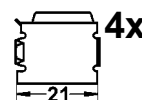
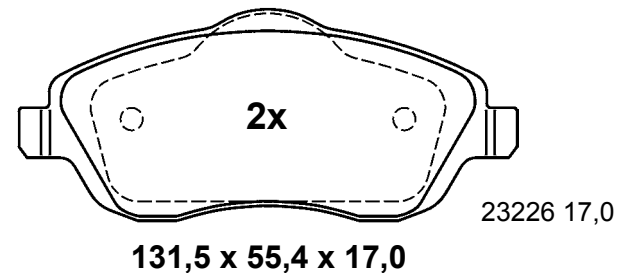
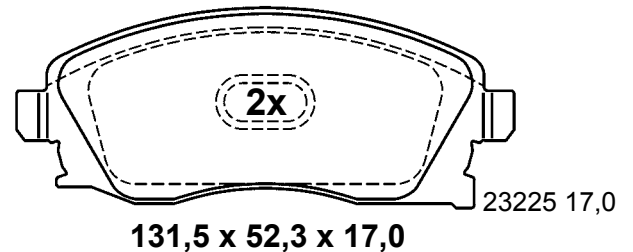

# Illustrations disc brake pads

Illustrations plaquettes de frein à disque / Illustrazioni pastiglie freno /  
 Figuras Calços do travão de disco / Rysunki okładzin hamulców tarczowych /  
 Zobrazení obložení kotoučových brzd

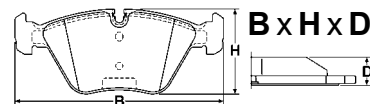

scale - échelle - scala - escala - skala - měřítko 1:2

## B1.G102-0547.2 G1020547



RENAULT



ATE

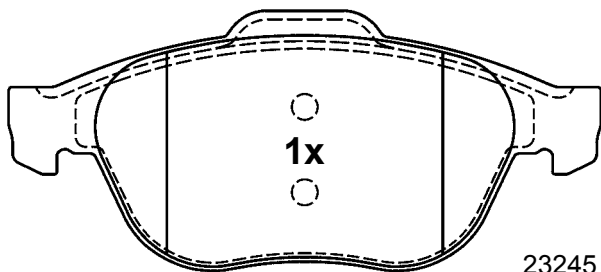

156,3 x 68,3 x 18,3

23245 18,3

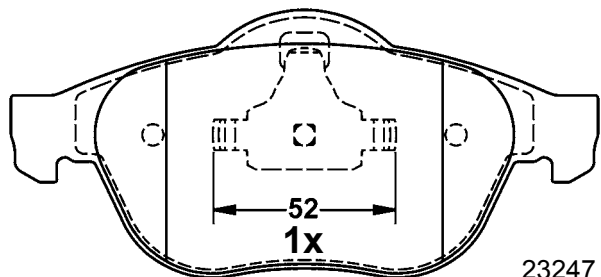

155,1 x 70,8 x 18,3

23247 18,3

## B1.G102-0548.2 G1020548



RENAULT



ATE

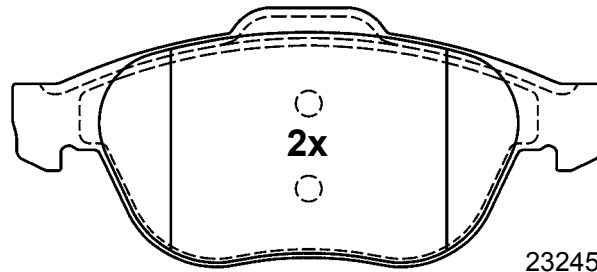

156,3 x 68,3 x 18,3

23245 18,3

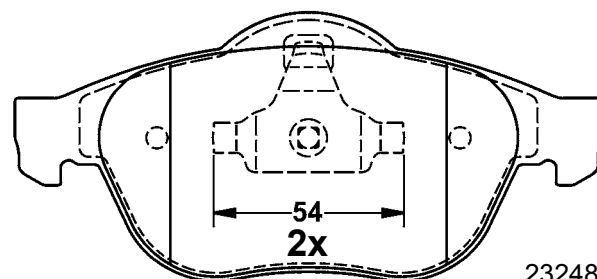

155,1 x 70,8 x 18,3

23248 18,3

## B1.G102-0549.2 G1020549



AUDI, CITROEN, FIAT, FORD,  
 LANCIA, PEUGEOT, SEAT,  
 VOLKSWAGEN



LUC

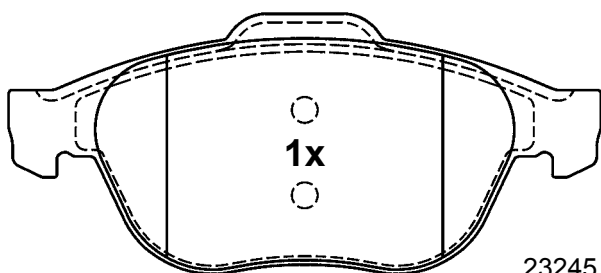

156,3 x 68,3 x 18,3

23245 18,3

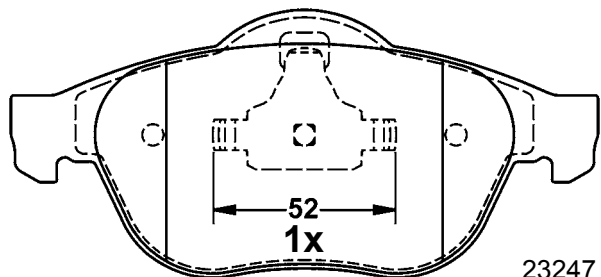

155,1 x 70,8 x 18,3

23247 18,3

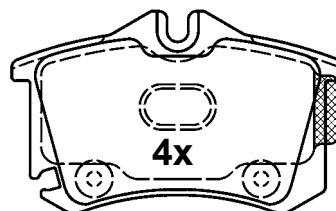

87,2 x 52,9 x 17,1

20961 17,1



M8x21

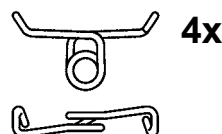

4x



# Illustrations disc brake pads

Illustrations plaquettes de frein à disque / Illustrazioni pastiglie freno /  
 Figuras Calços do travão de disco / Rysunki okładzin hamulców tarczowych /  
 Zobrazení obložení kotoučových brzd

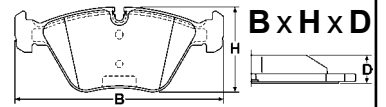

scale - échelle - scala - escala - skala - měřítko 1:2

## B1.G102-0550.2 G1020550

OPEL, VAUXHALL

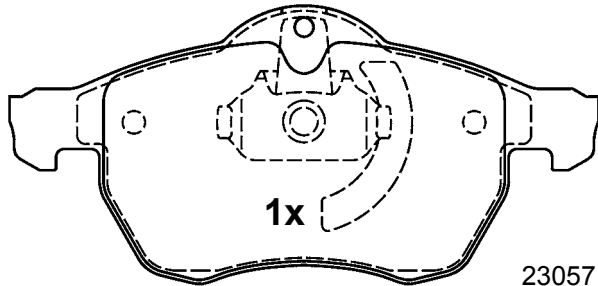

23057 20,2

155,1 x 71,4 x 20,2

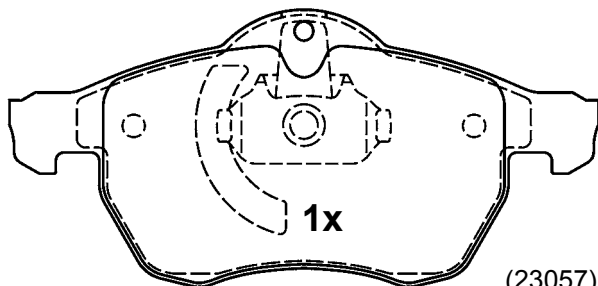

(23057) 20,2

155,1 x 71,4 x 20,2

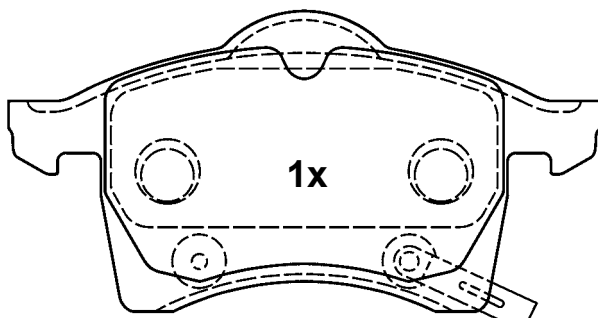

23058 19,6

156,3 x 78,5 x 19,6

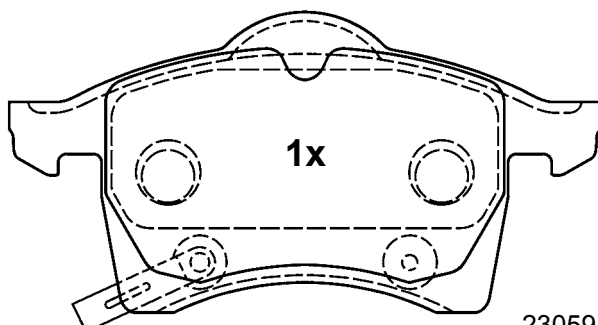

23059 19,6

156,3 x 78,5 x 19,6

## B1.G102-0554.2 G1020554

OPEL, VAUXHALL

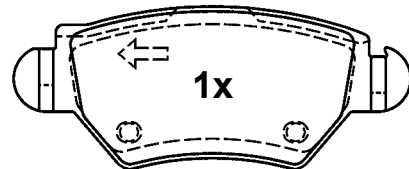

23258 16,5

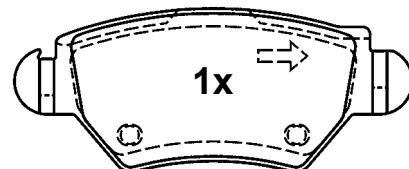

23259 16,5

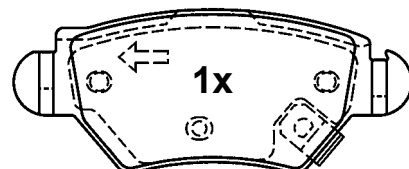

23262 16,5

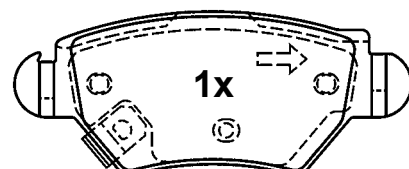

23263 16,5

104,6 x 42,7 x 16,5

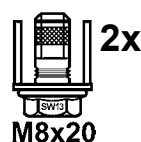

# Illustrations disc brake pads

Illustrations plaquettes de frein à disque / Illustrazioni pastiglie freno /  
Figuras Calços do travão de disco / Rysunki okładzin hamulców tarczowych /  
Zobrazení obložení kotoučových brzd

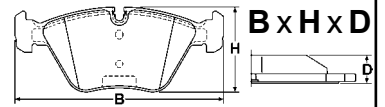

scale - échelle - scala - escala - skala - měřítko 1:2

## B1.G102-0557.2 G1020557



FORD, SEAT, VOLKSWAGEN



ATE

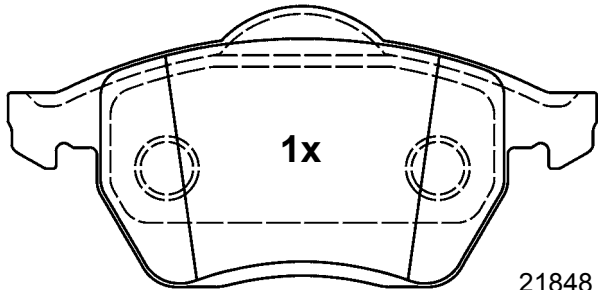

21848 19,8

156,3 x 74,0 x 19,8

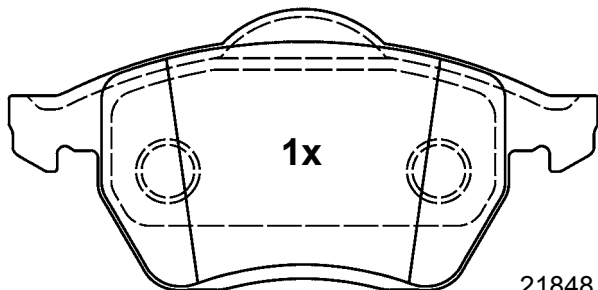

21848 19,8

156,3 x 74,0 x 19,8

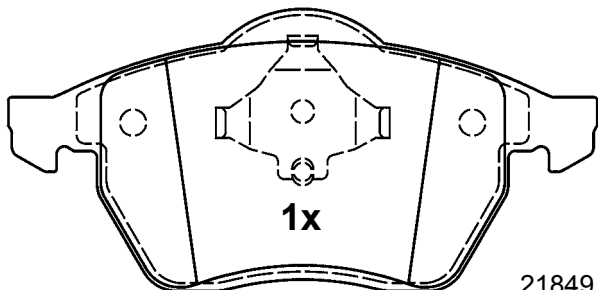

21849 19,8

156,3 x 74,0 x 19,8

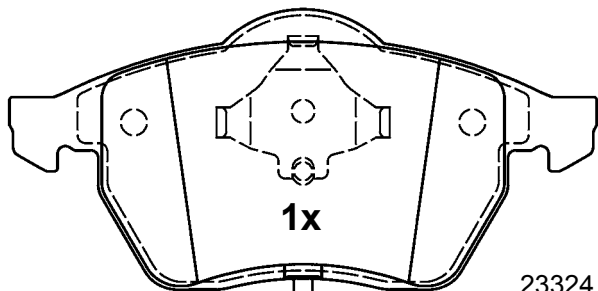

23324 20,3

200mm

156,3 x 74,0 x 20,3

## B1.G102-0559.2 G1020559



AUDI



LUC

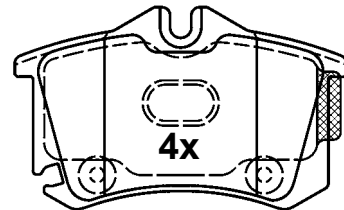

23554 16,3

87,2 x 52,9 x 16,3

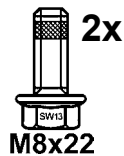

M8x22

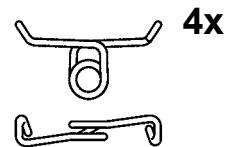

4x

## B1.G102-0560.2 G1020560



FIAT, OPEL, VAUXHALL



LUC

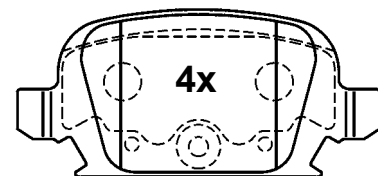

23284 14,0

95,6 x 43,8 x 14,0

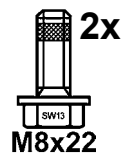

M8x22

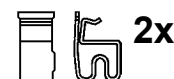







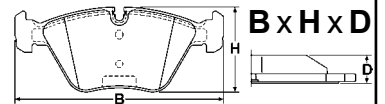





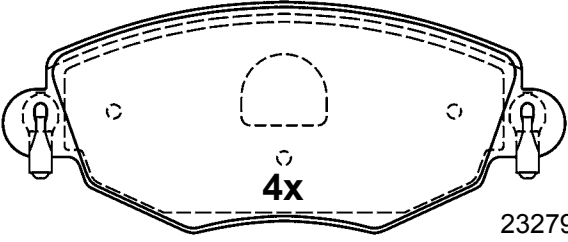



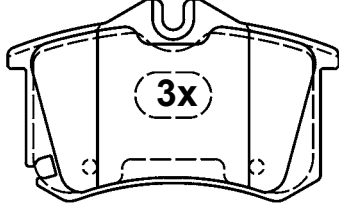
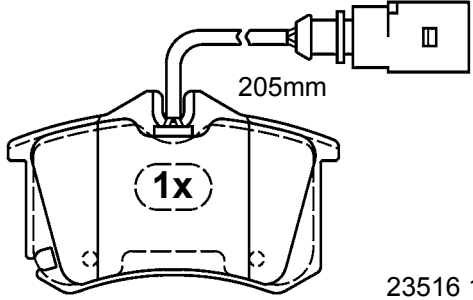

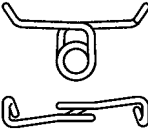
2x

# Illustrations disc brake pads

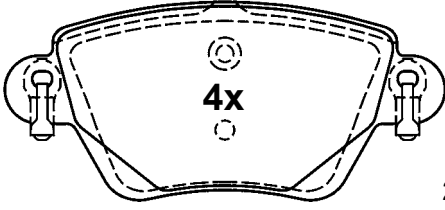
Illustrations plaquettes de frein à disque / Illustrazioni pastiglie freno /  
 Figuras Calços do travão de disco / Rysunki okładzin hamulców tarczowych /  
 Zobrazení obložení kotoučových brzd

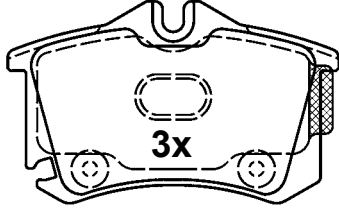
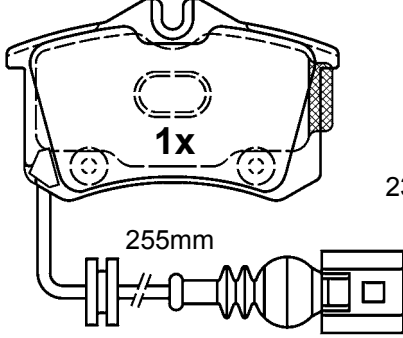

scale - échelle - scala - escala - skala - měřítko 1:2

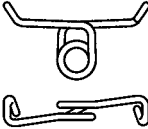
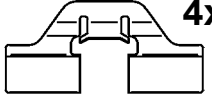





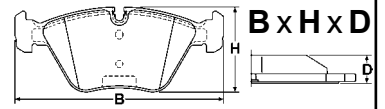



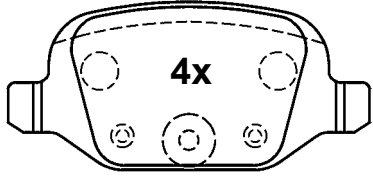
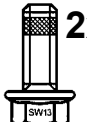

B1.G102-0562.2 G1020562	B1.G102-0564.2 G1020564
<p> FORD, JAGUAR  BOS</p>  <p>4x 23279 18,4</p>  <p>22 2x M8x1</p> <p>148,8 x 60,5 x 18,4</p>	<p> FORD, SEAT, VOLKSWAGEN  LUC</p>  <p>3x 20961 16,8</p>  <p>205mm 1x 23516 16,8</p> <p>87,2 x 52,9 x 16,8</p>  <p>2x M8x21</p>  <p>4x</p>  <p>4x</p>
B1.G102-0563.2 G1020563	B1.G102-0566.2 G1020566
<p> FORD, JAGUAR, RENAULT  BOS</p>  <p>4x 23557 17,2</p>  <p>22 2x M8x22</p> <p>115,8 x 51,8 x 17,2</p>	<p> SEAT, SKODA, VOLKSWAGEN  LUC</p>  <p>3x 23554 17,1</p>  <p>255mm 1x 23823 17,1</p> <p>87,2 x 52,9 x 17,1</p>  <p>2x M8x22</p>  <p>4x</p>  <p>4x</p>

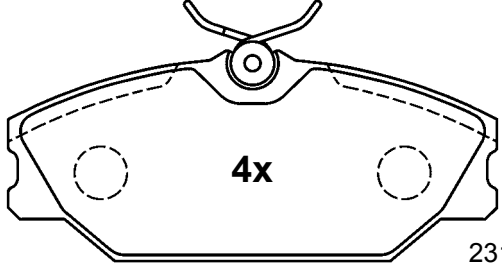
# Illustrations disc brake pads

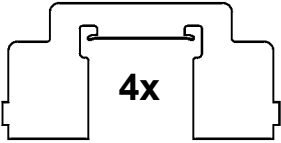
Illustrations plaquettes de frein à disque / Illustrazioni pastiglie freno /  
 Figuras Calços do travão de disco / Rysunki okładzin hamulców tarczowych /  
 Zobrazení obložení kotoučových brzd

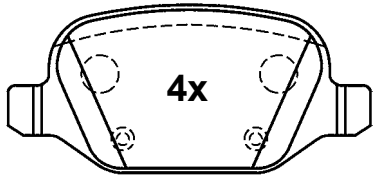
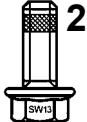

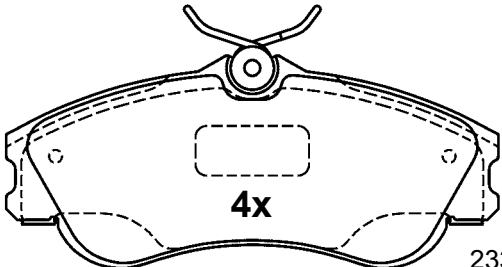
scale - échelle - scala - escala - skala - měřítko 1:2

B1.G102-0567.2 G1020567	B1.G102-0569.2 G1020569
<p> FIAT, LANCIA  LUC</p>  <p>23601 13,7</p>  <p>2x M8x22</p> <p>95,6 x 43,9 x 13,7</p>	<p> RENAULT  LUC</p>  <p>23172 18,0</p> <p>128,6 x 55,5 x 18,0</p>  <p>4x M8x21</p>  <p>4x</p>
B1.G102-0568.2 G1020568	B1.G102-0570.2 G1020570
<p> ALFA ROMEO, LANCIA  LUC</p>  <p>23517 16,6</p>  <p>2x M8x22</p> <p>95,6 x 43,9 x 16,6</p>	<p> CITROEN, PEUGEOT  LUC</p>  <p>23346 19,0</p>  <p>2x M8x21</p> <p>129,9 x 56,2 x 19,0</p>

# Illustrations disc brake pads

Illustrations plaquettes de frein à disque / Illustrazioni pastiglie freno /  
 Figuras Calços do travão de disco / Rysunki okładzin hamulców tarczowych /  
 Zobrazení obložení kotoučových brzd

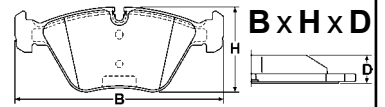

scale - échelle - scala - escala - skala - měřítko 1:2

<b>B1.G102-0572.2 G1020572</b>	<b>B1.G102-0574.2 G1020574</b>
--------------------------------	--------------------------------

**ALFA ROMEO, LANCIA**

**4x**

23760 17,7

**2x**

M8x22

116,8 x 49,8 x 17,7

**MERCEDES BENZ**

**2x**

23271 17,6

1,8

**2x**

(23271) 17,6

1,8

119,5 x 71,7 x 17,6

**B1.G102-0573.2 G1020573**

**LANCIA**

**4x**

24073 16,7

**2x**

M8x22

116,8 x 55,2 x 16,7

**B1.G102-0575.2 G1020575**

**MERCEDES BENZ**

**4x**

23157 15,8

76,5 x 65,5 x 15,8

**4x**

# Illustrations disc brake pads

Illustrations plaquettes de frein à disque / Illustrazioni pastiglie freno /  
 Figuras Calços do travão de disco / Rysunki okładzin hamulców tarczowych /  
 Zobrazení obložení kotoučových brzd

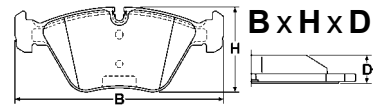

scale - échelle - scala - escala - skala - měřítko 1:2

## B1.G102-0576.2 G1020576



RENAULT



ATE

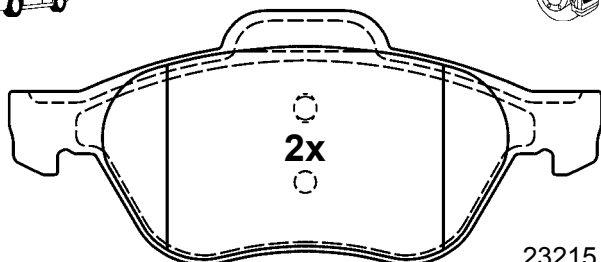

2x

156,3 x 66,8 x 18,3

23215 18,3

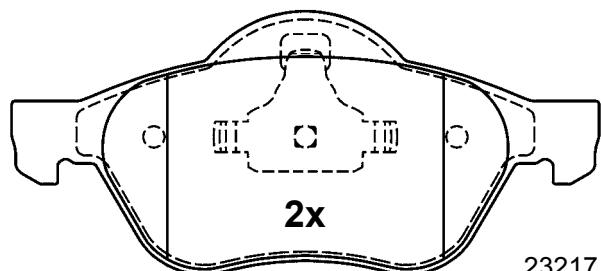

2x

155,1 x 68,9 x 18,3

23217 18,3

## B1.G102-0580.2 G1020580



FORD, SEAT, VOLKSWAGEN



ATE

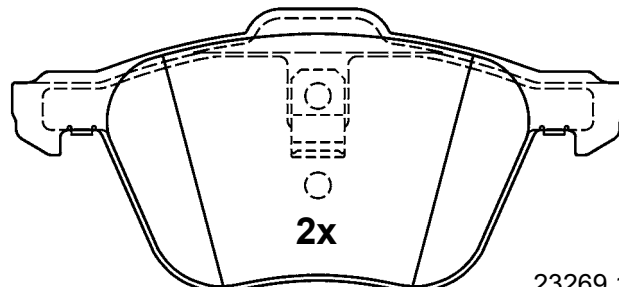

2x

161,3 x 74,4 x 19,8

23269 19,8

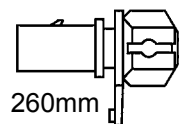

260mm

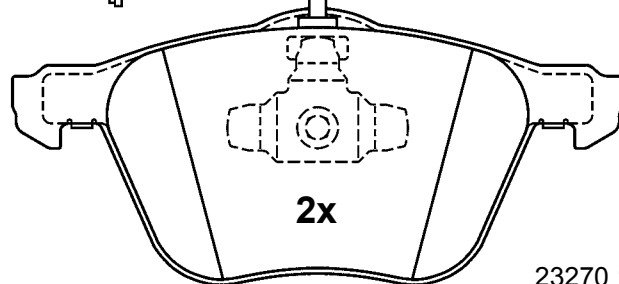

2x

161,3 x 72,9 x 19,8

23270 19,8

## B1.G102-0578.2 G1020578



VOLVO



ATE

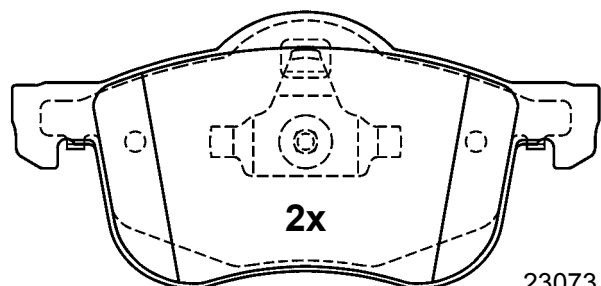

2x

155,1 x 72,5 x 18,8

23073 18,8

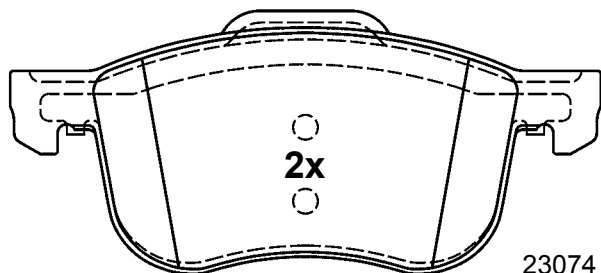

2x

156,3 x 69,1 x 18,8

23074 18,8

## B1.G102-0582.2 G1020582



MERCEDES BENZ



BOS

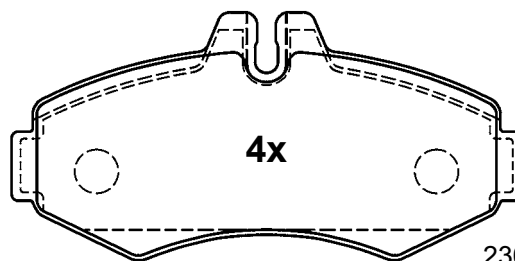

4x

23022 20,9

134,4 x 64,5 x 20,9

# Illustrations disc brake pads

Illustrations plaquettes de frein à disque / Illustrazioni pastiglie freno /

Figuras Calços do travão de disco / Rysunki okładzin hamulców tarczowych /

Zobrazení obložení kotoučových brzd

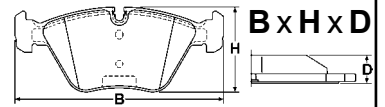

scale - échelle - scala - escala - skala - měřítko 1:2

## B1.G102-0583.2 G1020583



MERCEDES BENZ,  
VOLKSWAGEN



BOS

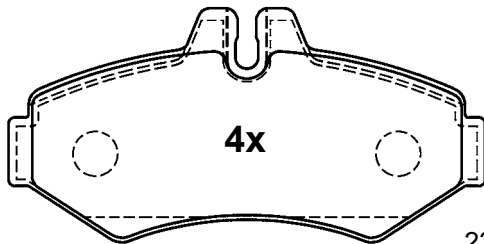

23021 18,9

125,8 x 61,9 x 18,9

## B1.G102-0586.2 G1020586



BMW



ATE

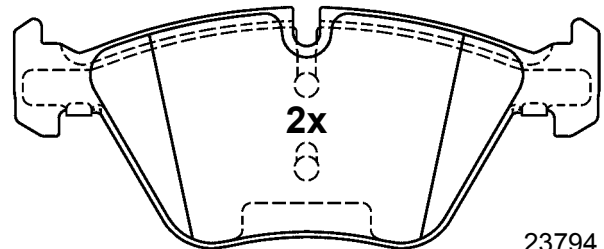

23794 20,3

154,6 x 63,5 x 20,3

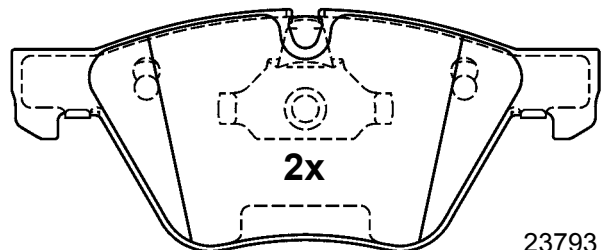

23793 20,3

155,1 x 63,5 x 20,3

## B1.G102-0584.2 G1020584



MERCEDES BENZ



BOS

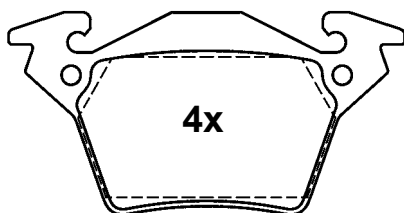

23020 17,9

105,0 x 52,9 x 17,9

## B1.G102-0588.2 G1020588



BMW



ATE

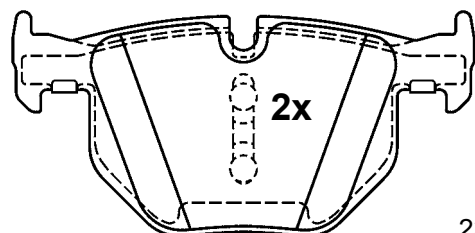

23732 17,3

121,8 x 59,2 x 17,3

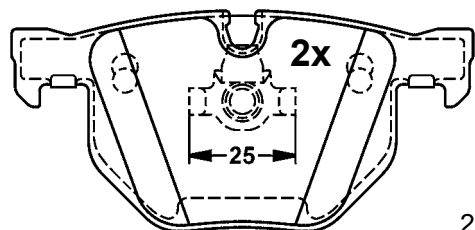

23737 17,3

121,8 x 57,8 x 17,3

# Illustrations disc brake pads

Illustrations plaquettes de frein à disque / Illustrazioni pastiglie freno /

Figuras Calços do travão de disco / Rysunki okładzin hamulców tarczowych /

Zobrazení obložení kotoučových brzd

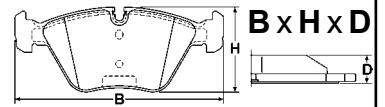

scale - échelle - scala - escala - skala - měřítko 1:2

## B1.G102-0591.2 G1020591



BMW, MG, ROVER



ATE

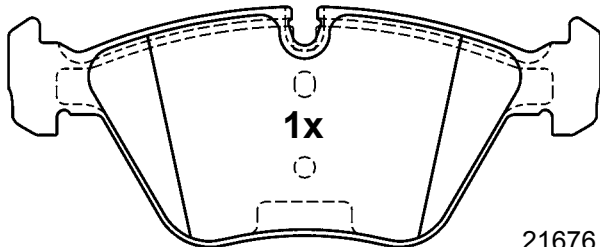

1x

156,3 x 63,5 x 20,3

21676 20,3

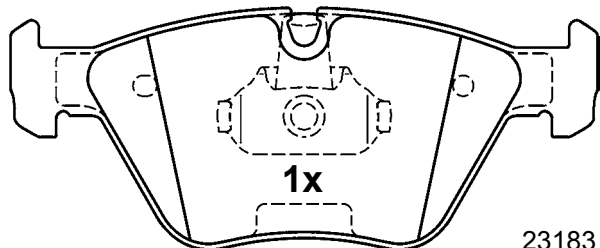

1x

155,1 x 63,5 x 20,3

23183 20,3

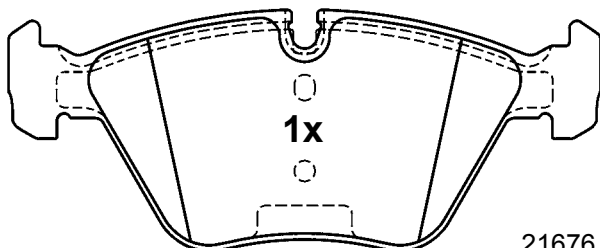

1x

156,3 x 63,5 x 20,3

21676 20,3

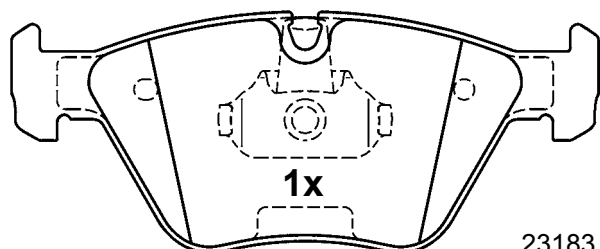

1x

155,1 x 63,5 x 20,3

23183 20,3

## B1.G102-0593.2 G1020593



FORD, SEAT, VOLKSWAGEN



ATE

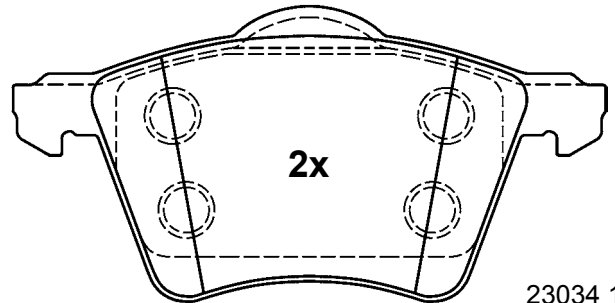

2x

156,3 x 78,5 x 18,8

23034 18,8

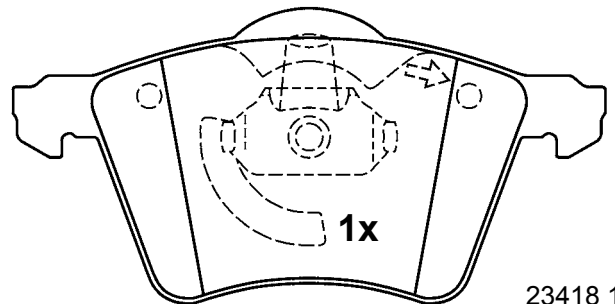

1x

156,3 x 78,5 x 19,4

23418 19,4

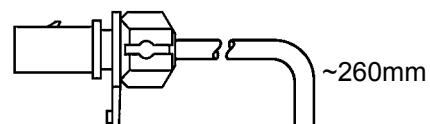

~260mm

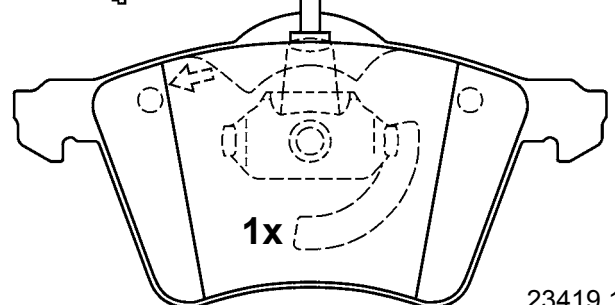

1x

156,3 x 78,5 x 19,4

23419 19,4



# Illustrations disc brake pads

Illustrations plaquettes de frein à disque / Illustrazioni pastiglie freno /

Figuras Calços do travão de disco / Rysunki okładzin hamulców tarczowych /

Zobrazení obložení kotoučových brzd

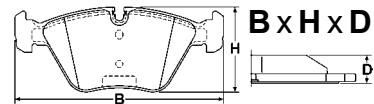

scale - échelle - scala - escala - skala - měřítko 1:2

**B1.G102-0595.2 G1020595**

**B1.G102-0597.2 G1020597**

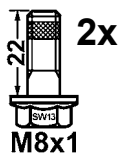
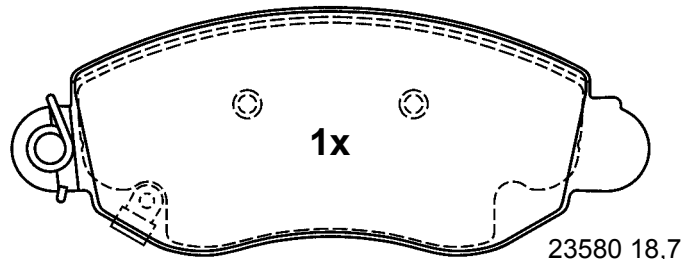
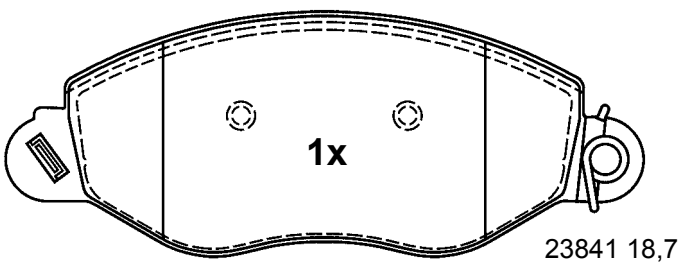
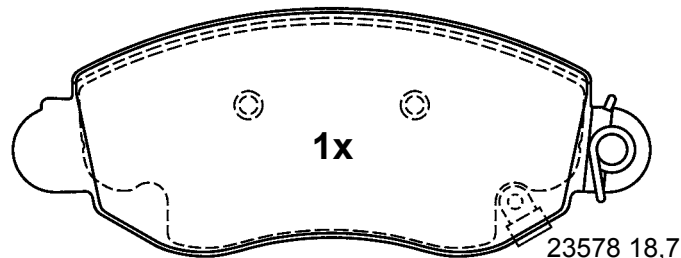
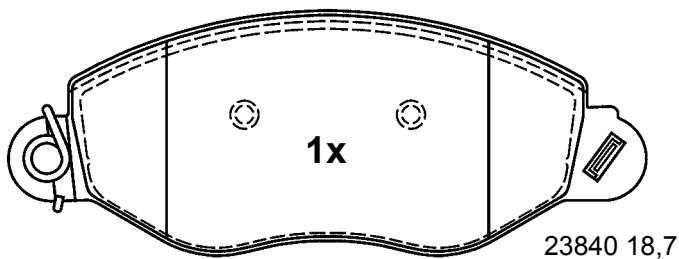
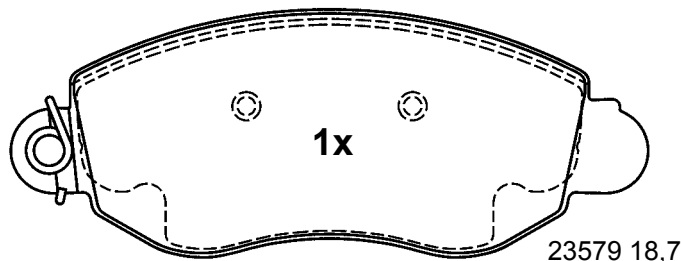
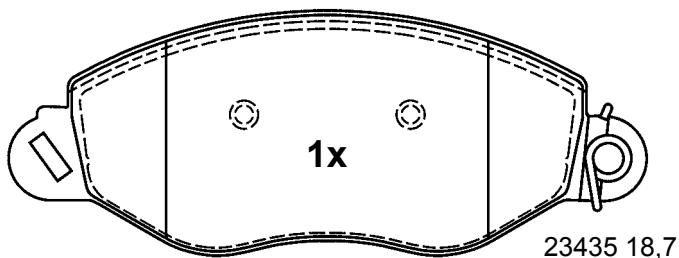
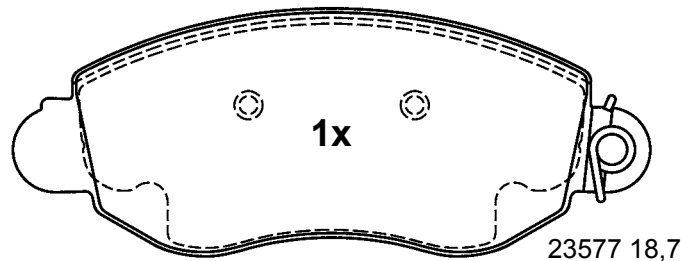
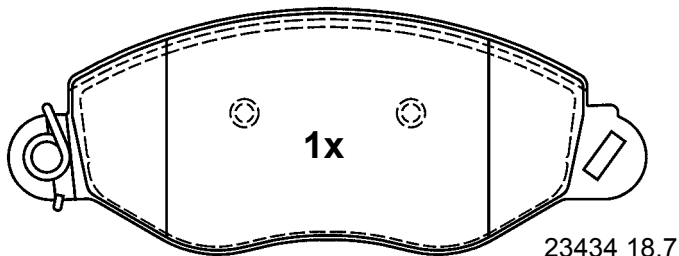

168,3 x 63,9 x 18,7

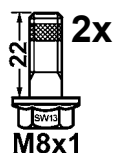

168,5 x 65,1 x 18,7

# Illustrations disc brake pads

Illustrations plaquettes de frein à disque / Illustrazioni pastiglie freno /  
 Figuras Calços do travão de disco / Rysunki okładzin hamulców tarczowych /  
 Zobrazení obložení kotoučových brzd

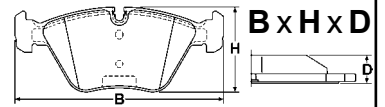

scale - échelle - scala - escala - skala - měřítko 1:2

<b>B1.G102-0602.2 G1020602</b>	<b>B1.G102-0604.2 G1020604</b>
--------------------------------	--------------------------------

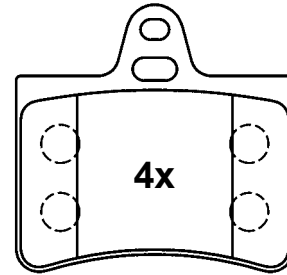
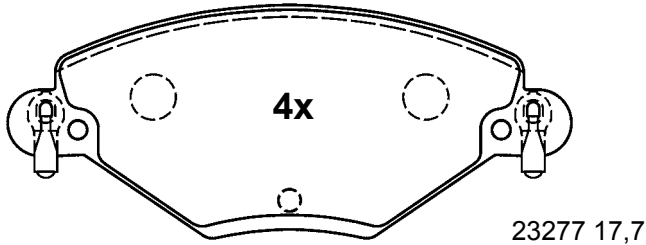

148,7 x 61,2 x 17,7

23305 15,2



73,1 x 70,6 x 15,2

<b>B1.G102-0603.2 G1020603</b>	<b>B1.G102-0605.2 G1020605</b>
--------------------------------	--------------------------------

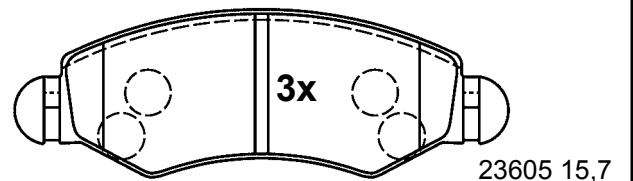
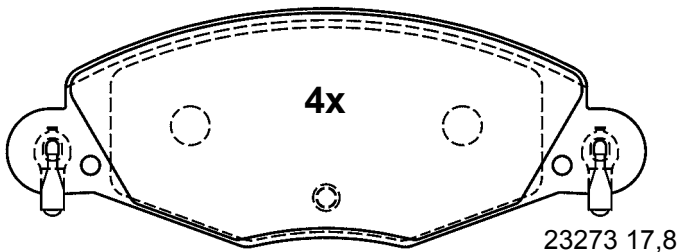
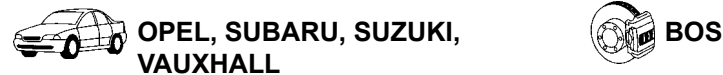

168,7 x 62,8 x 17,8

23605 15,7

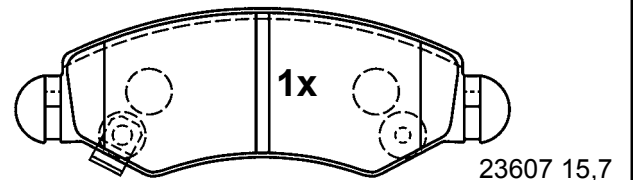

23607 15,7

130,7 x 43,9 x 15,7



# Illustrations disc brake pads

Illustrations plaquettes de frein à disque / Illustrazioni pastiglie freno /  
Figuras Calços do travão de disco / Rysunki okładzin hamulców tarczowych /  
Zobrazení obložení kotoučových brzd

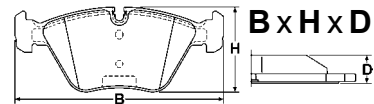

scale - échelle - scala - escala - skala - měřítko 1:2

## B1.G102-0608.2 G1020608



BMW



ATE

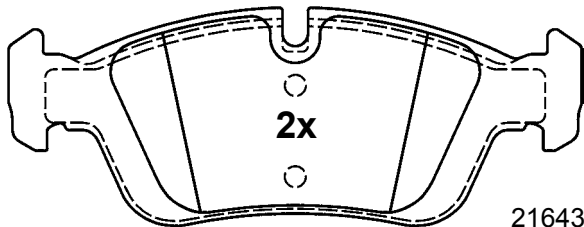

2x

21643 17,8

151,3 x 57,3 x 17,8

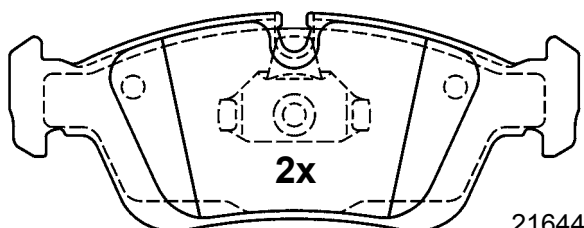

2x

21644 17,8

150,1 x 57,3 x 17,8

## B1.G102-0613.2 G1020613



FIAT



BOS

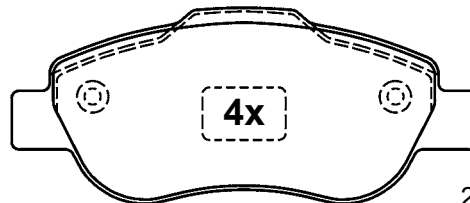

4x

24072 17,9

122,8 x 51,7 x 17,9

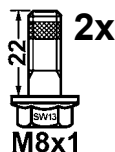

2x

M8x1

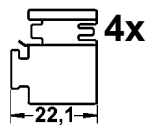

4x

22,1

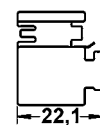

4x

22,1

## B1.G102-0614.2 G1020614



CITROEN, FIAT, LANCIA



BOS

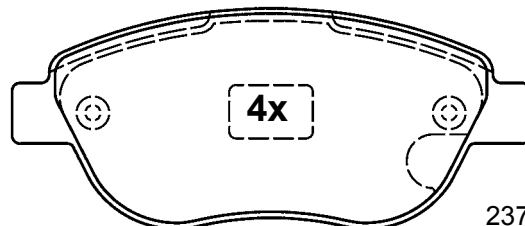

4x

23708 19,0

136,8 x 57,4 x 19,0

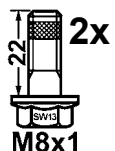

2x

M8x1

## B1.G102-0610.2 G1020610



OPEL, VAUXHALL



LUC

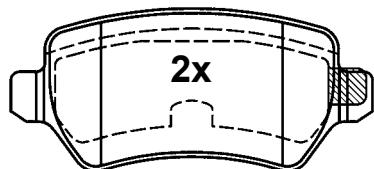

2x

23417 15,3

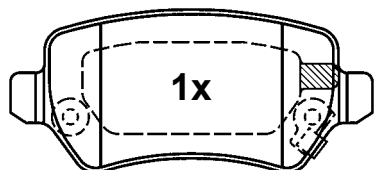

1x

23654 15,3

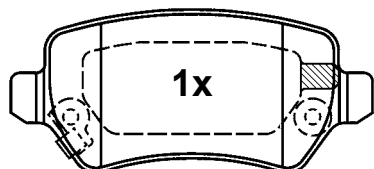

1x

23655 15,3

95,3 x 42,8 x 15,3

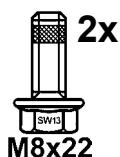

2x

M8x22

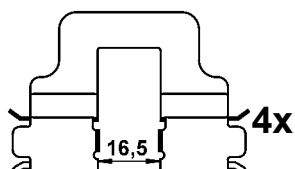

4x

16,5

## B1.G102-0615.2 G1020615



MERCEDES BENZ



LUC

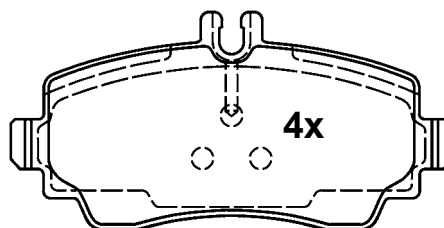

4x

23070 19,4

116,5 x 57,1 x 19,4

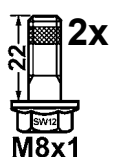

2x

M8x1

# Illustrations disc brake pads

Illustrations plaquettes de frein à disque / Illustrazioni pastiglie freno /  
 Figuras Calços do travão de disco / Rysunki okładzin hamulców tarczowych /  
 Zobrazení obložení kotoučových brzd

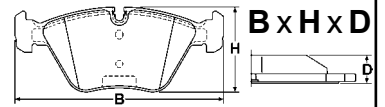

scale - échelle - scala - escala - skala - měřítko 1:2

## B1.G102-0617.2 G1020617



FORD



BDX

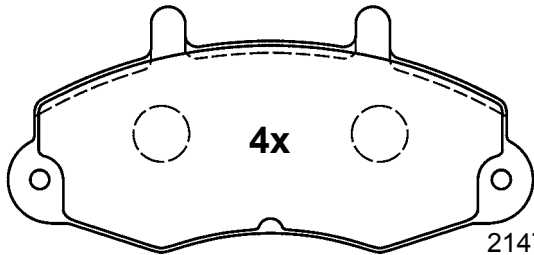

21470 18,0

138,7 x 64,1 x 18,0

## B1.G102-0622.2 G1020622



FORD, MAZDA, VOLVO



ATE

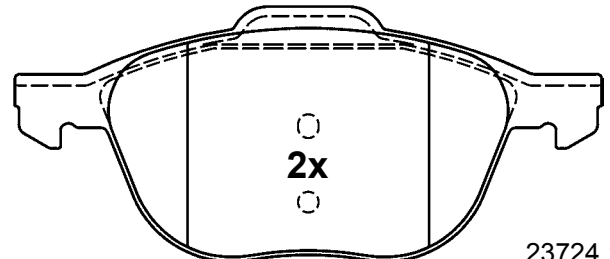

23724 18,1

156,3 x 67,0 x 18,1

## B1.G102-0618.2 G1020618



FORD



BDX

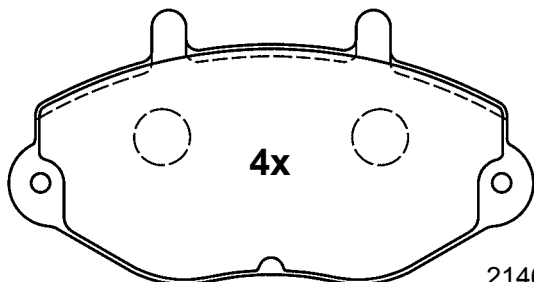

21469 18,0

138,7 x 72,1 x 18,0

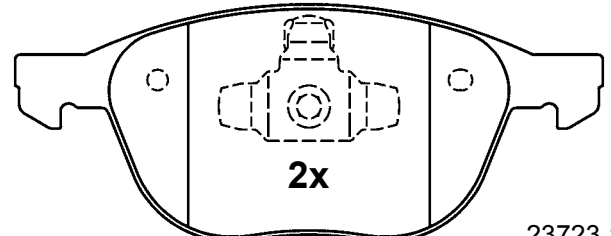

23723 18,1

155,1 x 62,4 x 18,1

## B1.G102-0624.2 G1020624



NISSAN, OPEL, RENAULT,  
VAUXHALL



BOS

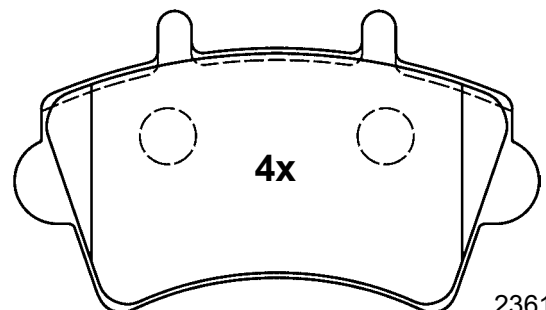

23613 17,7

138,7 x 79,6 x 17,7

## B1.G102-0621.2 G1020621



FIAT



BDX

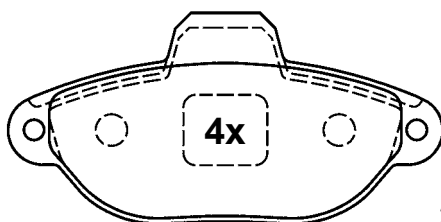

21436 17,0

114,8 x 55,5 x 17,0



2x

# Illustrations disc brake pads

Illustrations plaquettes de frein à disque / Illustrazioni pastiglie freno /  
 Figuras Calços do travão de disco / Rysunki okładzin hamulców tarczowych /  
 Zobrazení obložení kotoučových brzd

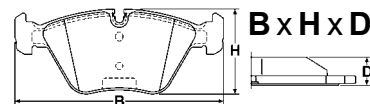

scale - échelle - scala - escala - skala - měřítko 1:2

## B1.G102-0625.2 G1020625



FORD, JAGUAR



BOS

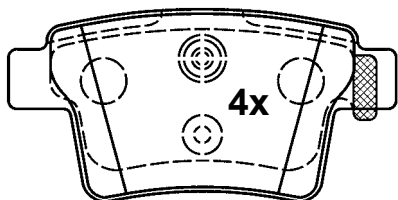

24260 16,4

101,8 x 50,5 x 16,4

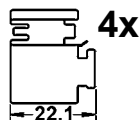
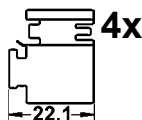
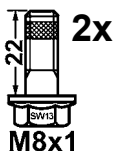

## B1.G102-0627.2 G1020627



NISSAN, OPEL, RENAULT,  
VAUXHALL



BOS

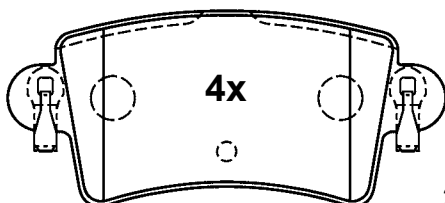

23669 16,8

115,6 x 51,4 x 16,8

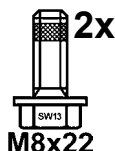

## B1.G102-0632.2 G1020632



MERCEDES BENZ



BOS

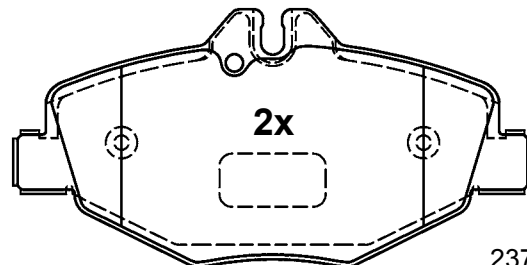

23743 20,1

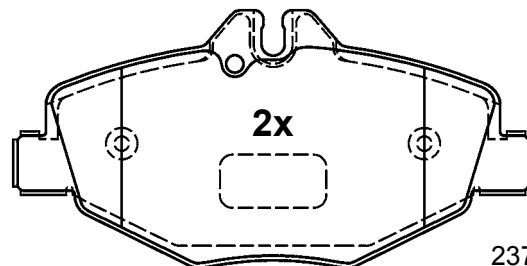
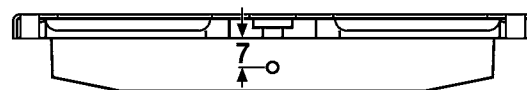

23744 20,1

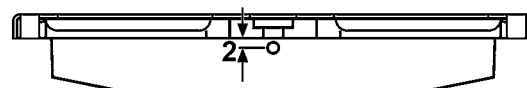

137,0 x 67,8 x 20,1

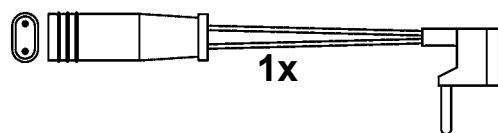
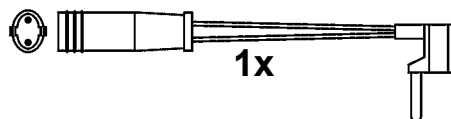

## B1.G102-0630.2 G1020630



CITROEN, PEUGEOT



BOS

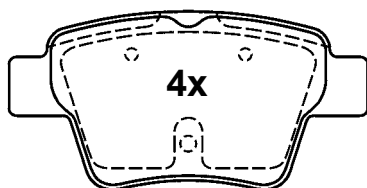

24150 17,6

94,8 x 46,9 x 17,6

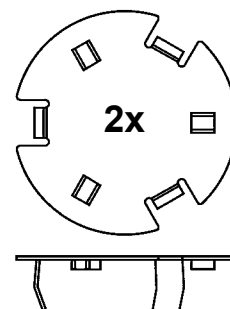
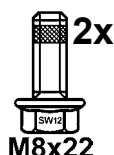
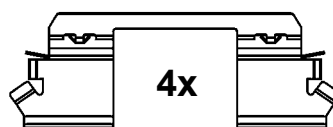
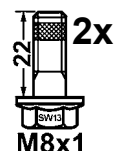





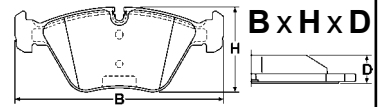



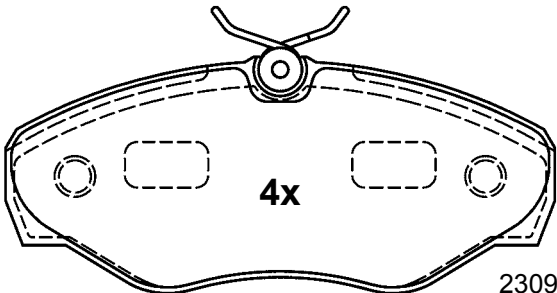

# Illustrations disc brake pads

Illustrations plaquettes de frein à disque / Illustrazioni pastiglie freno /  
 Figuras Calços do travão de disco / Rysunki okładzin hamulców tarczowych /  
 Zobrazení obložení kotoučových brzd

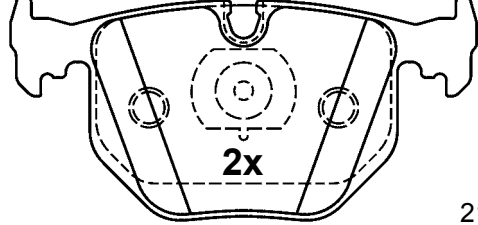
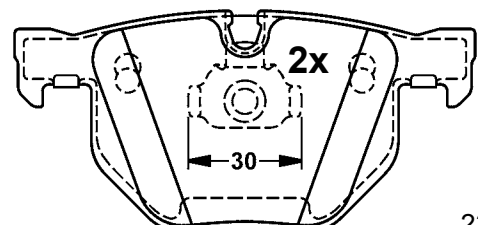

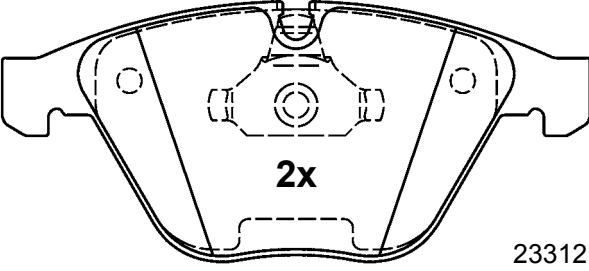
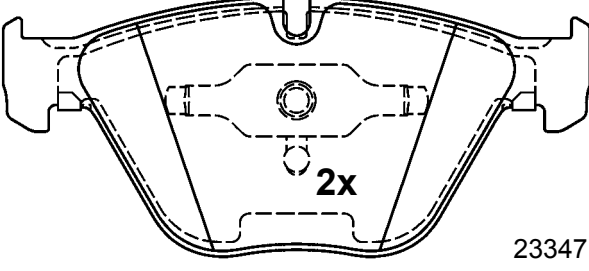
scale - échelle - scala - escala - skala - měřítko 1:2

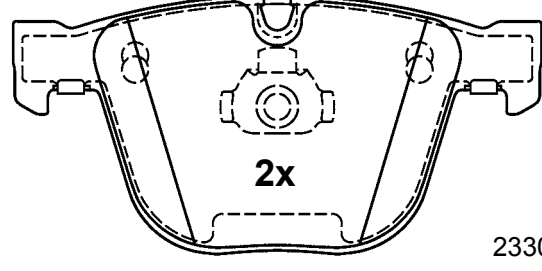
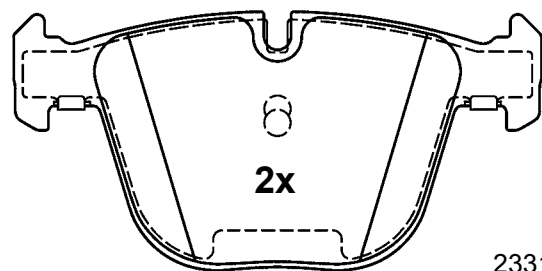
<b>B1.G102-0633.2 G1020633</b>	<b>B1.G102-0637.2 G1020637</b>
<div style="display: flex; justify-content: space-between;"> <div data-bbox="71 324 534 398">  <p>NISSAN, OPEL, RENAULT VAUXHALL</p> </div> <div data-bbox="646 324 790 392">  <p>LUC</p> </div> </div> <div style="text-align: center; margin-top: 20px;">  <p><b>4x</b></p> <p>23099 18,4</p> </div> <div style="margin-top: 20px;">  <p><b>4x</b></p> <p>M8x22</p> <p>144,8 x 62,4 x 18,4</p> </div>	<div style="display: flex; justify-content: space-between;"> <div data-bbox="813 324 1013 380">  <p>BMW</p> </div> <div data-bbox="1396 324 1540 392">  <p>ATE</p> </div> </div> <div style="text-align: center; margin-top: 20px;">  <p><b>2x</b></p> <p>21282 17,3</p> <p>123,0 x 59,2 x 17,3</p> </div> <div style="text-align: center; margin-top: 20px;">  <p><b>2x</b></p> <p>30</p> <p>23447 17,3</p> <p>121,8 x 57,8 x 17,3</p> </div>
<b>B1.G102-0634.2 G1020634</b>	<b>B1.G102-0638.2 G1020638</b>
<div style="display: flex; justify-content: space-between;"> <div data-bbox="71 1265 263 1310">  <p>BMW</p> </div> <div data-bbox="646 1254 790 1321">  <p>ATE</p> </div> </div> <div style="text-align: center; margin-top: 20px;">  <p><b>2x</b></p> <p>23312 20,3</p> </div> <div style="text-align: center; margin-top: 20px;">  <p><b>2x</b></p> <p>23347 20,3</p> <p>155,1 x 68,3 x 20,3</p> </div>	<div style="display: flex; justify-content: space-between;"> <div data-bbox="813 1265 1013 1310">  <p>BMW</p> </div> <div data-bbox="1396 1254 1540 1321">  <p>ATE</p> </div> </div> <div style="text-align: center; margin-top: 20px;">  <p><b>2x</b></p> <p>23309 17,3</p> </div> <div style="text-align: center; margin-top: 20px;">  <p><b>2x</b></p> <p>23310 17,3</p> <p>139,5 x 67,8 x 17,3</p> </div>



# Illustrations disc brake pads

Illustrations plaquettes de frein à disque / Illustrazioni pastiglie freno /  
Figuras Calços do travão de disco / Rysunki okładzin hamulców tarczowych /  
Zobrazení obložení kotoučových brzd

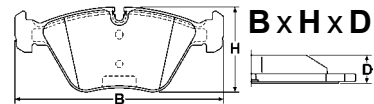

scale - échelle - scala - escala - skala - měřítko 1:2

## B1.G102-0642.2 G1020642



OPEL, SAAB, VAUXHALL



ATE

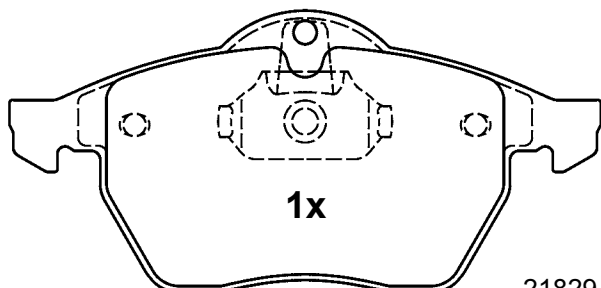

1x

21829 20,3

155,1 x 74,0 x 20,3

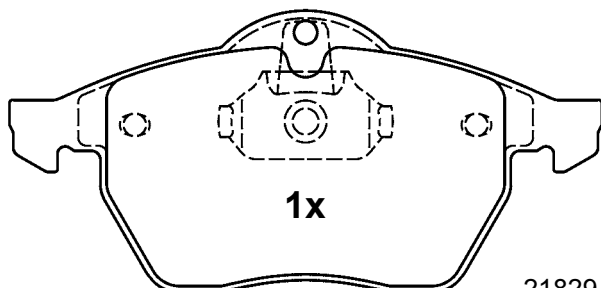

1x

21829 20,3

155,1 x 74,0 x 20,3

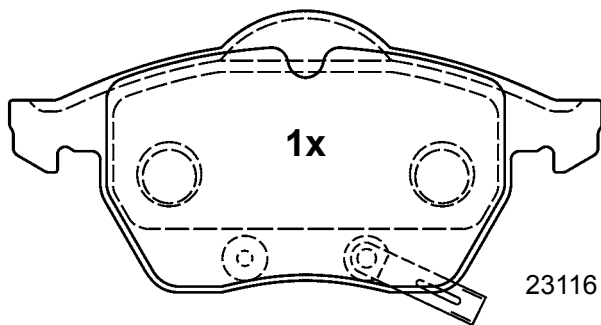

1x

23116 19,8

156,3 x 74,0 x 19,8

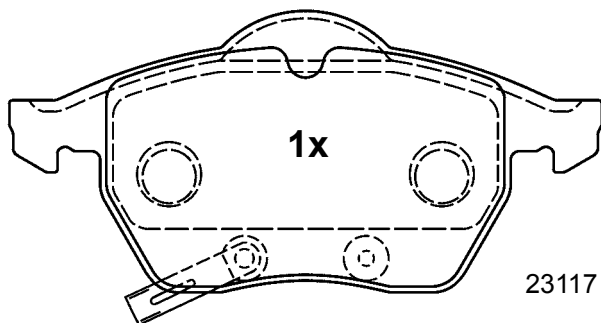

1x

23117 19,8

156,3 x 74,0 x 19,8

## B1.G102-0644.2 G1020644



AUDI



ATE

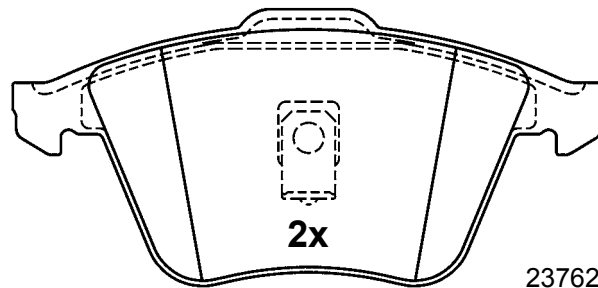

2x

23762 20,3

156,3 x 72,9 x 20,3

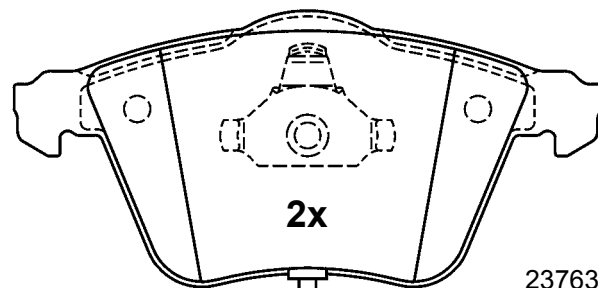

2x

23763 20,3

200mm

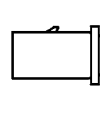

155,1 x 72,9 x 20,3

## B1.G102-0646.2 G1020646



MINI



ATE

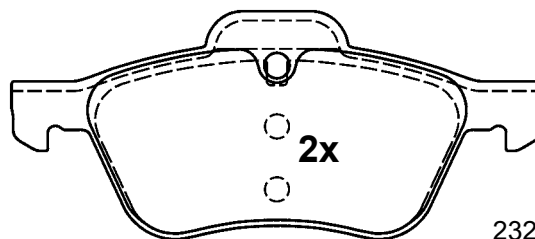

2x

23281 18,3

140,1 x 59,8 x 18,3

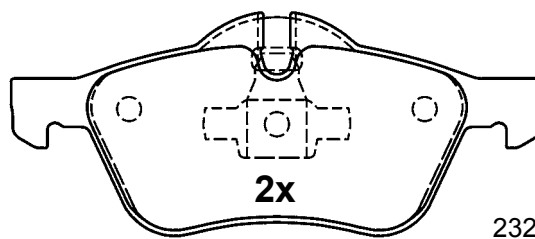

2x

23282 18,3

140,1 x 58,7 x 18,3

# Illustrations disc brake pads

Illustrations plaquettes de frein à disque / Illustrazioni pastiglie freno /  
 Figuras Calços do travão de disco / Rysunki okładzin hamulców tarczowych /  
 Zobrazení obložení kotoučových brzd

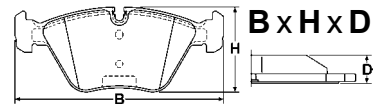

scale - échelle - scala - escala - skala - měřítko 1:2

<b>B1.G102-0648.2 G1020648</b>	<b>B1.G102-0652.2 G1020652</b>
--------------------------------	--------------------------------

**MINI**

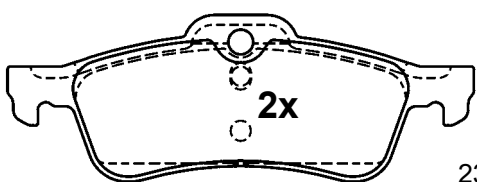

23716 15,8

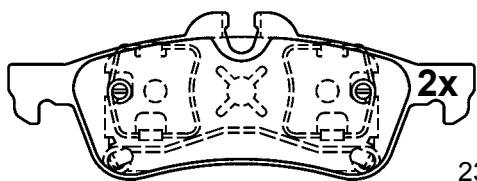

23717 15,8

**123,0 x 43,8 x 15,8**

**MERCEDES BENZ**

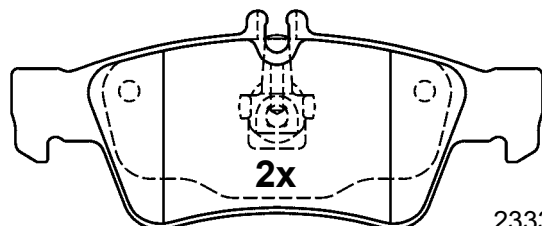

23334 16,7

**140,1 x 57,5 x 16,7**

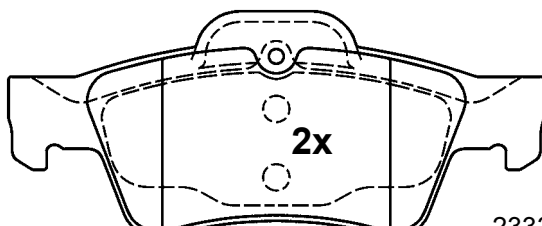

23335 16,7

**141,3 x 59,4 x 16,7**

**B1.G102-0650.2 G1020650**

**FIAT, OPEL, SAAB, VAUXHALL**

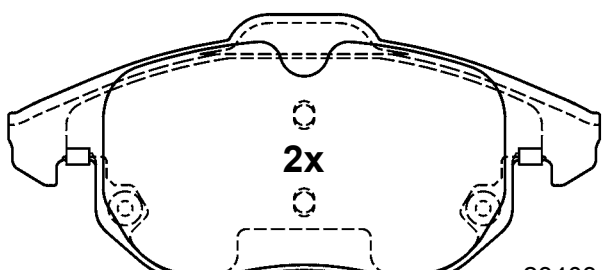

23403 20,1

**156,3 x 70,7 x 20,1**

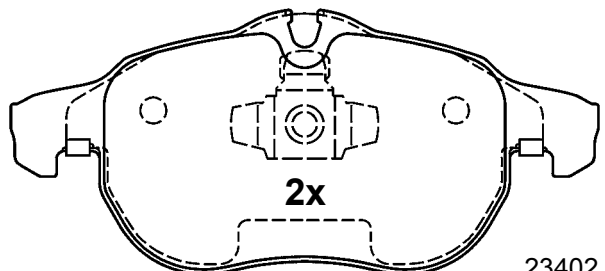

23402 20,1

**155,1 x 69,6 x 20,1**

**B1.G102-0654.2 G1020654**

**FORD, SEAT, VOLKSWAGEN**

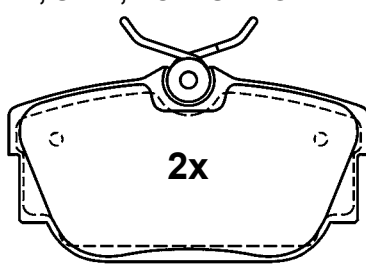

23224 16,5

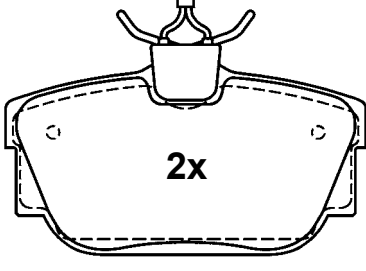

23446 16,5

**94,7 x 50,9 x 16,5**

190mm



**2x**  
M8x21



**2x**

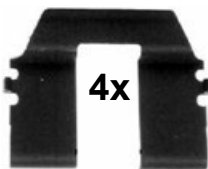

**4x**





# Illustrations disc brake pads

Illustrations plaquettes de frein à disque / Illustrazioni pastiglie freno /  
Figuras Calços do travão de disco / Rysunki okładzin hamulców tarczowych /  
Zobrazení obložení kotoučových brzd

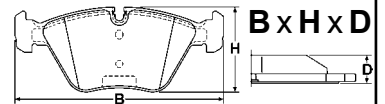

scale - échelle - scala - escala - skala - měřítko 1:2

## B1.G102-0658.2 G1020658



VOLKSWAGEN



LUC

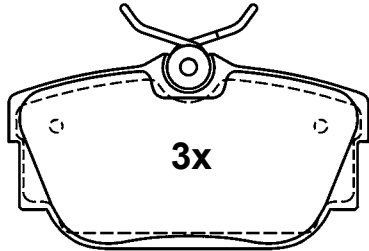

3x

23224 16,5

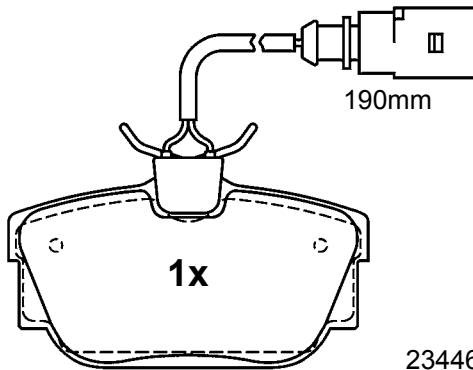

190mm

1x

23446 16,5

94,7 x 50,9 x 16,5



2x

M8x21



1x

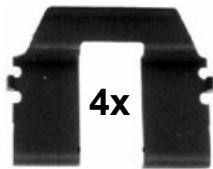

4x

## B1.G102-0659.2 G1020659



MERCEDES BENZ



BRE

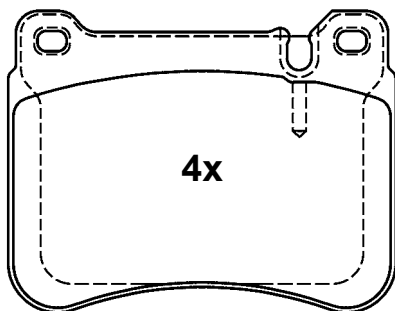

4x

23945 16,5

101,7 x 79,3 x 16,5

## B1.G102-0660.2 G1020660



CITROEN, PEUGEOT



LUC

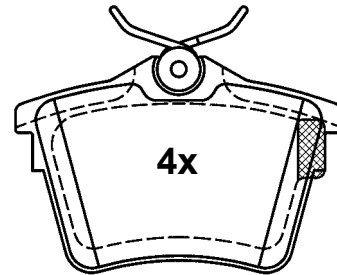

4x

24135 17,7



2x

M8x22

86,1 x 56,9 x 17,7

## B1.G102-0661.2 G1020661



MERCEDES BENZ



LUC

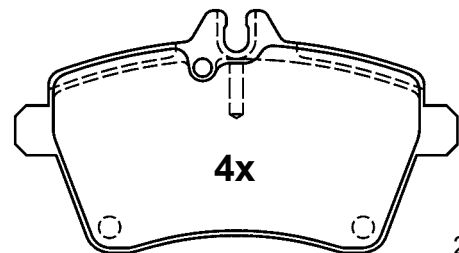

4x

24077 19,1

116,4 x 63,8 x 19,1



2x

M8x21

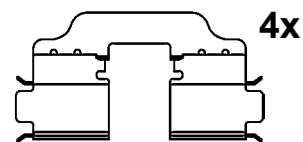

4x

# Illustrations disc brake pads

Illustrations plaquettes de frein à disque / Illustrazioni pastiglie freno /  
 Figuras Calços do travão de disco / Rysunki okładzin hamulców tarczowych /  
 Zobrazení obložení kotoučových brzd

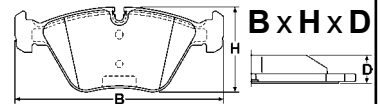

scale - échelle - scala - escala - skala - měřítko 1:2

## B1.G102-0662.2 G1020662



TOYOTA



BOS

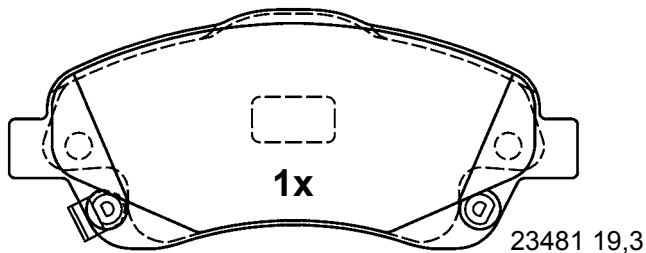
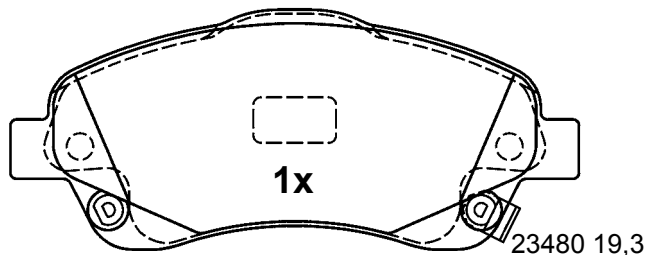
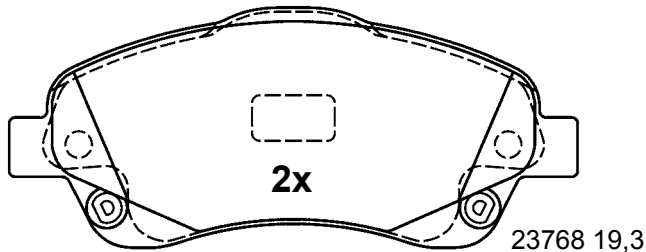

150,8 x 63,0 x 19,3

## B1.G102-0666.2 G1020666



TOYOTA



ATE

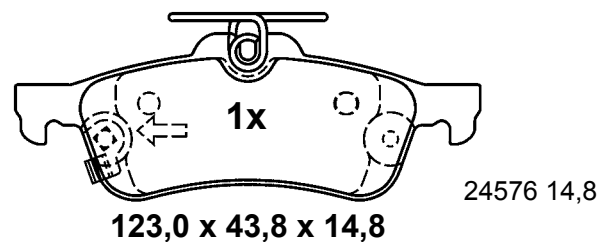
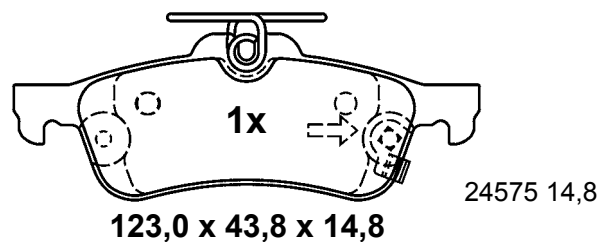
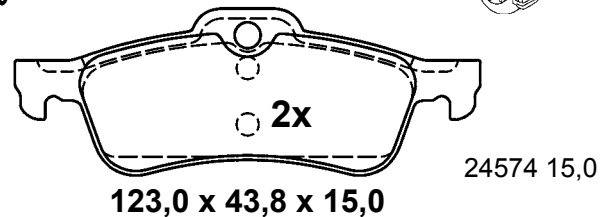

## B1.G102-0663.2 G1020663



TOYOTA



BOS

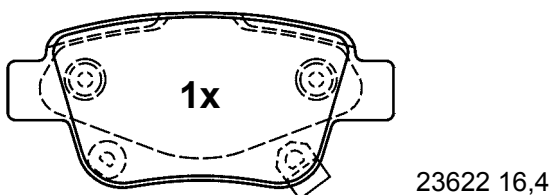
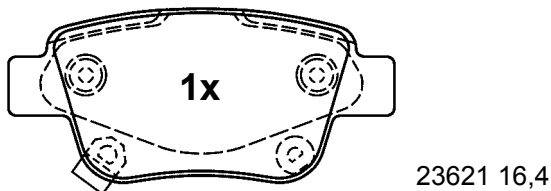
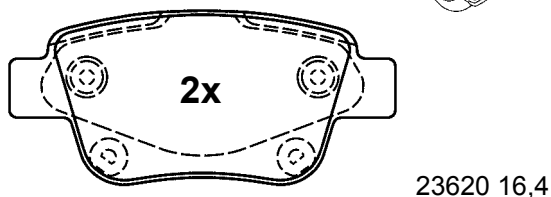

101,8 x 45,9 x 16,4

## B1.G102-0670.2 G1020670



FORD, OPEL, SAAB, VAUXHALL



ATE

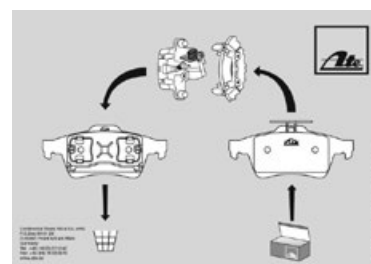
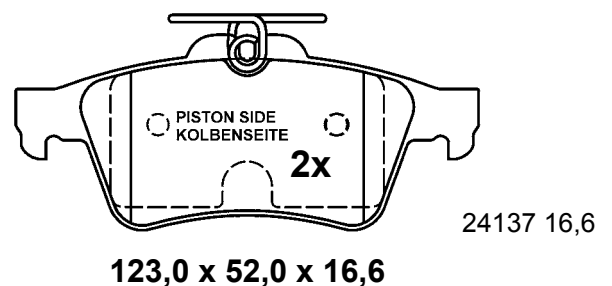
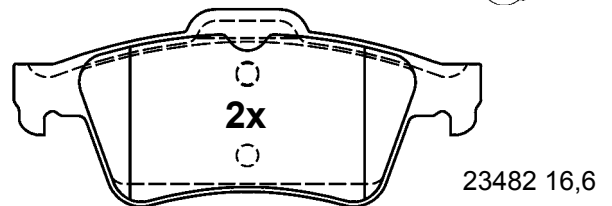

# Illustrations disc brake pads

Illustrations plaquettes de frein à disque / Illustrazioni pastiglie freno /  
 Figuras Calços do travão de disco / Rysunki okładzin hamulców tarczowych /  
 Zobrazení obložení kotoučových brzd

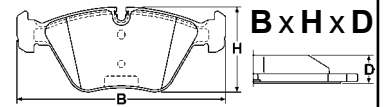

scale - échelle - scala - escala - skala - měřítko 1:2

<b>B1.G102-0672.2 G1020672</b>	<b>B1.G102-0677.2 G1020677</b>
--------------------------------	--------------------------------



FIAT



LUC

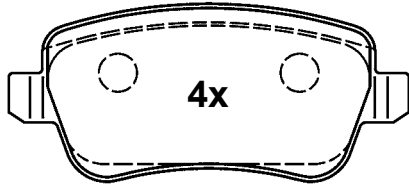

24348 17,1

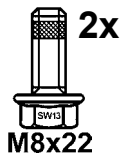

105,5 x 46,4 x 17,1



MERCEDES BENZ



BRE

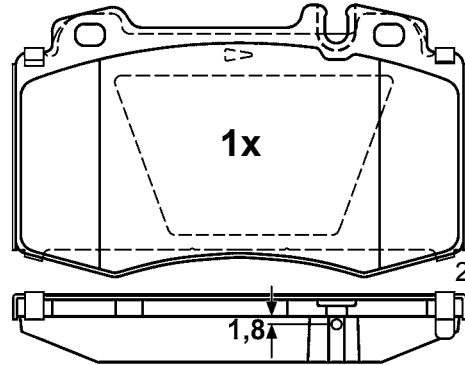

23271 17,6

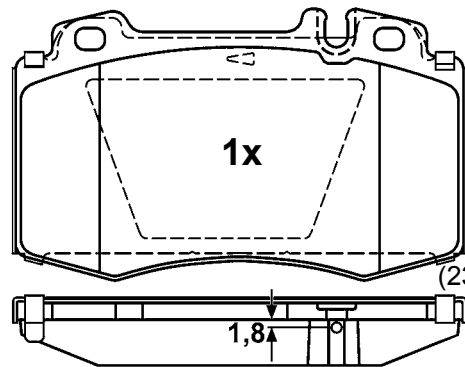

(23271) 17,6

<b>B1.G102-0676.2 G1020676</b>	
--------------------------------	--



AUDI, SEAT, VOLKSWAGEN



LUC

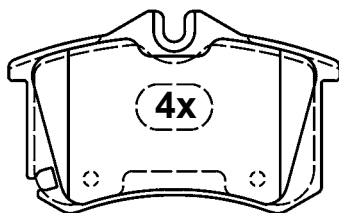

20961 15,8

87,2 x 52,9 x 15,8

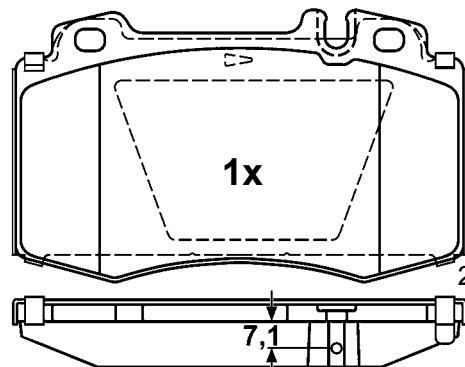
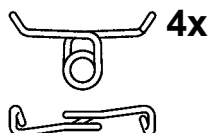

23745 17,6

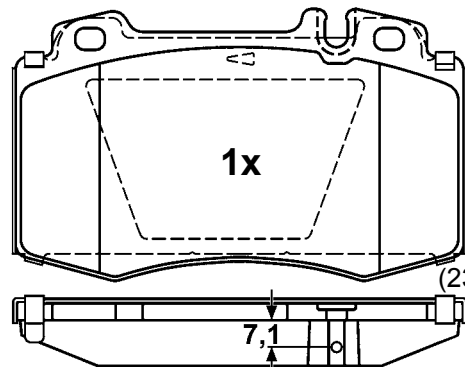

(23745) 17,6

119,3 x 71,7 x 17,6

# Illustrations disc brake pads



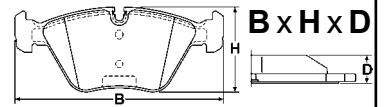

Illustrations plaquettes de frein à disque / Illustrazioni pastiglie freno /

Figuras Calços do travão de disco / Rysunki okładzin hamulców tarczowych /

Zobrazení obložení kotoučových brzd

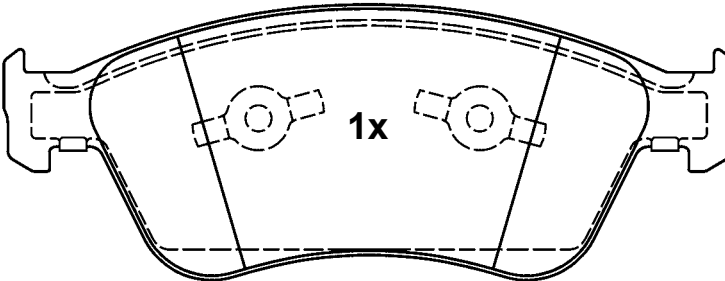
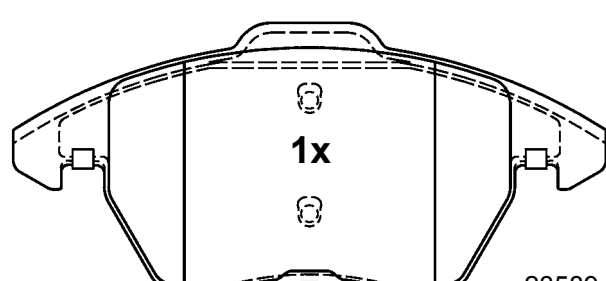
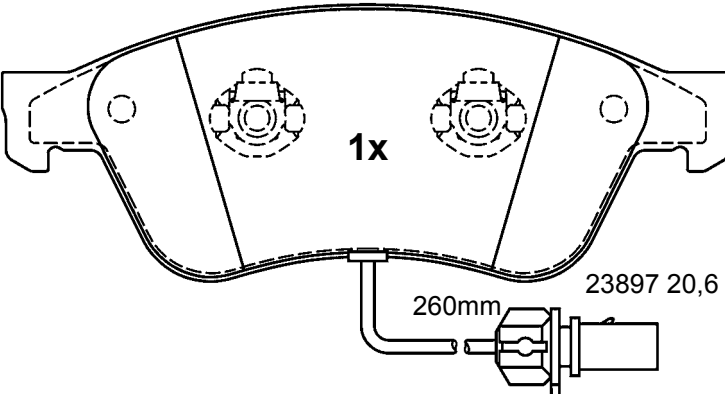
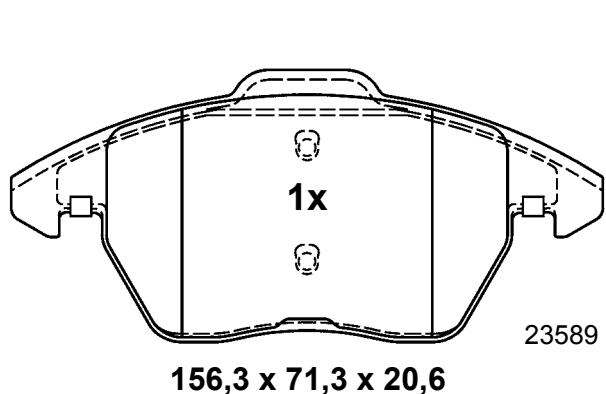
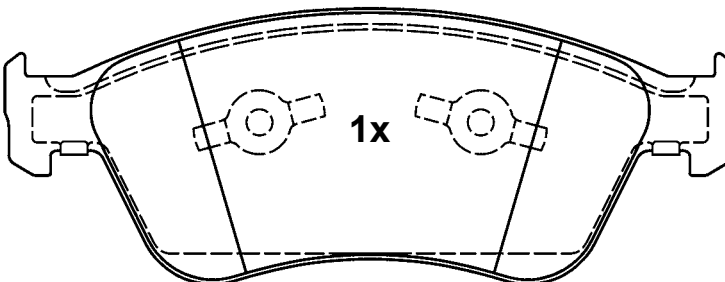
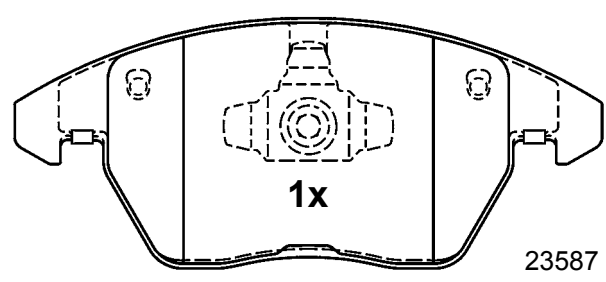
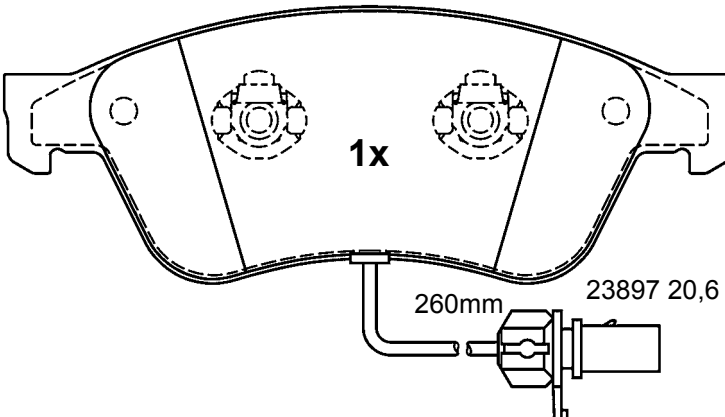
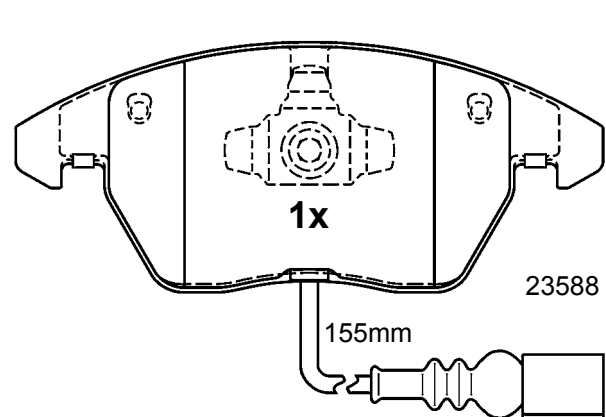

scale - échelle - scala - escala - skala - měřítko 1:2

B1.G102-0678.2 G1020678	B1.G102-0680.2 G1020680
 AUDI, VOLKSWAGEN  ATE	 AUDI, SEAT, SKODA VOLKSWAGEN  ATE
 <p>1x</p> <p>23896 20,6</p>	 <p>1x</p> <p>23589 20,6</p> <p>156,3 x 71,3 x 20,6</p>
 <p>1x</p> <p>260mm</p> <p>23897 20,6</p>	 <p>1x</p> <p>23589 20,6</p> <p>156,3 x 71,3 x 20,6</p>
 <p>1x</p> <p>23896 20,6</p>	 <p>1x</p> <p>23587 20,6</p> <p>155,1 x 66,0 x 20,6</p>
 <p>1x</p> <p>260mm</p> <p>23897 20,6</p> <p>193,0 x 72,6 x 20,6</p>	 <p>1x</p> <p>155mm</p> <p>23588 20,6</p> <p>155,1 x 66,0 x 20,6</p>



# Illustrations disc brake pads

Illustrations plaquettes de frein à disque / Illustrazioni pastiglie freno /  
Figuras Calços do travão de disco / Rysunki okładzin hamulców tarczowych /  
Zobrazení obložení kotoučových brzd

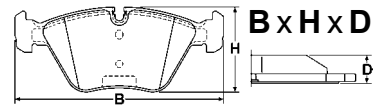

scale - échelle - scala - escala - skala - měřítko 1:2

<b>B1.G102-0682.2 G1020682</b>	<b>B1.G102-0685.2 G1020685</b>
--------------------------------	--------------------------------



AUDI, SEAT, SKODA,  
VOLKSWAGEN



LUC

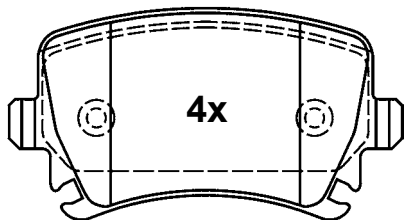

23914 17,1

105,3 x 55,9 x 17,1

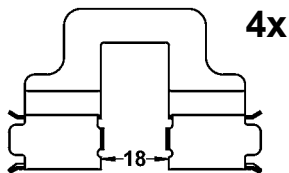
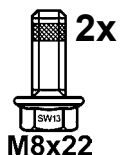

RENAULT



BOS

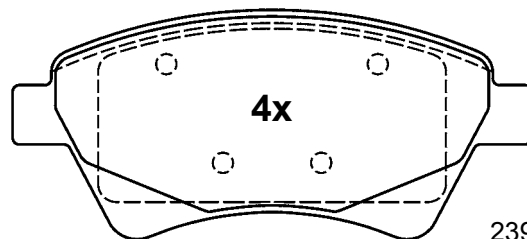

23930 18,2

136,8 x 59,9 x 18,2

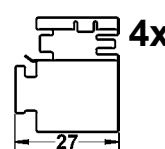
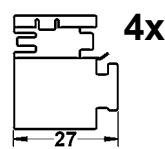
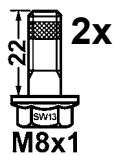

<b>B1.G102-0683.2 G1020683</b>	<b>B1.G102-0686.2 G1020686</b>
--------------------------------	--------------------------------



AUDI, BENTLEY, BMW, CHRYSLER,  
MERCEDES BENZ, ROLLS ROYCE  
VOLKSWAGEN



ATE

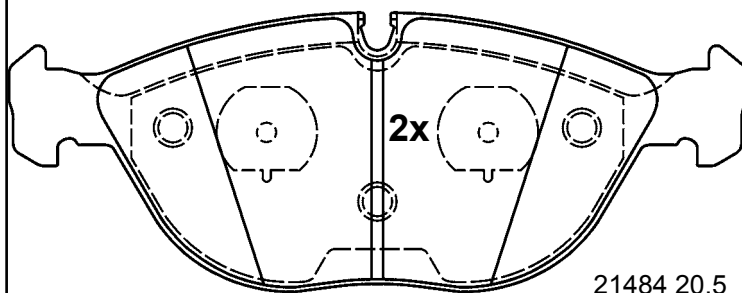

21484 20,5

194,3 x 73,5 x 20,5

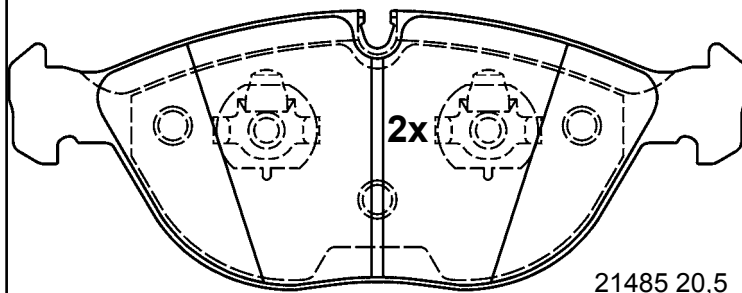

21485 20,5



CITROEN



LUC

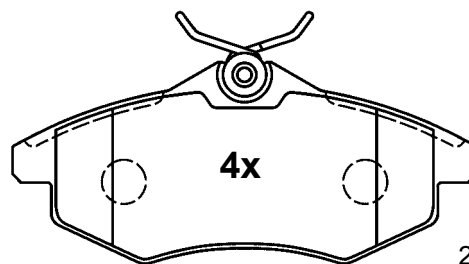

23407 19,0









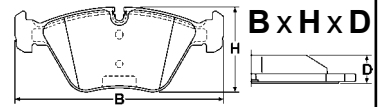

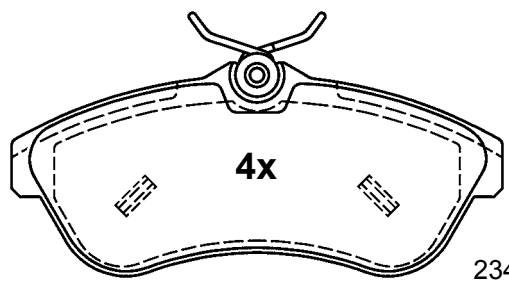

122,5 x 53,0 x 19,0

# Illustrations disc brake pads

Illustrations plaquettes de frein à disque / Illustrazioni pastiglie freno /  
 Figuras Calços do travão de disco / Rysunki okładzin hamulców tarczowych /  
 Zobrazení obložení kotoučových brzd

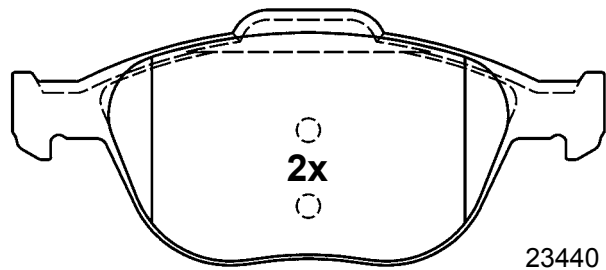
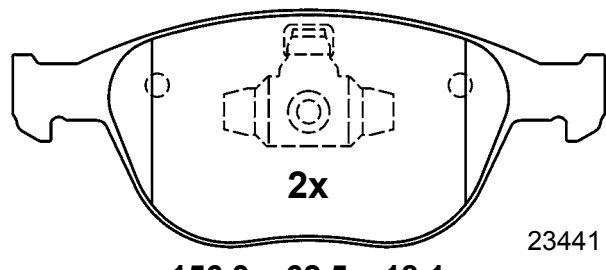

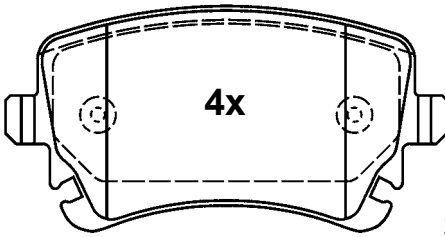
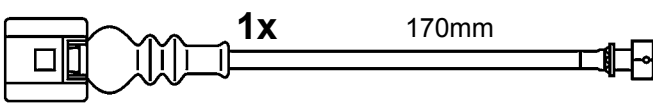
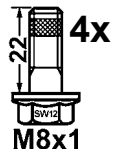
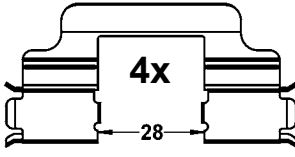
scale - échelle - scala - escala - skala - měřítko 1:2

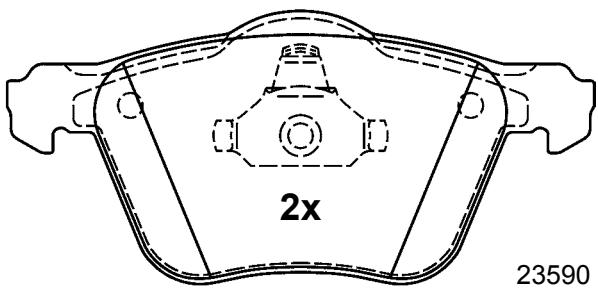
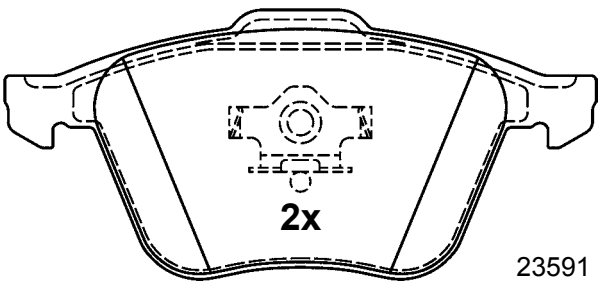
B1.G102-0687.2 G1020687	B1.G102-0692.2 G1020692
<div style="display: flex; justify-content: space-between;"> <div style="text-align: center;">  <p>CITROEN</p> </div> <div style="text-align: center;">  <p>LUC</p> </div> </div> <div style="text-align: center; margin-top: 20px;">  <p><b>4x</b></p> <p>23409 19,3</p> </div> <div style="margin-top: 20px;">  <p><b>2x</b></p> <p>M8x21</p> </div> <div style="text-align: center; margin-top: 10px;"> <p>128,8 x 56,1 x 19,3</p> </div>	<div style="display: flex; justify-content: space-between;"> <div style="text-align: center;">  <p>FORD</p> </div> <div style="text-align: center;">  <p>ATE</p> </div> </div> <div style="text-align: center; margin-top: 20px;">  <p><b>2x</b></p> <p>23440 17,6</p> <p>156,3 x 67,3 x 17,6</p> </div> <div style="text-align: center; margin-top: 20px;">  <p><b>2x</b></p> <p>23441 18,1</p> <p>156,3 x 62,5 x 18,1</p> </div>
B1.G102-0691.2 G1020691	B1.G102-0694.2 G1020694
<div style="display: flex; justify-content: space-between;"> <div style="text-align: center;">  <p>VOLKSWAGEN</p> </div> <div style="text-align: center;">  <p>LUC</p> </div> </div> <div style="text-align: center; margin-top: 20px;">  <p><b>4x</b></p> <p>23326 17,4</p> <p>116,1 x 59 x 17,4</p> </div> <div style="margin-top: 20px;">  <p><b>1x</b></p> <p>170mm</p> </div> <div style="margin-top: 20px;">  <p><b>4x</b></p> <p>M8x1</p> </div> <div style="text-align: center; margin-top: 10px;">  <p><b>4x</b></p> <p>28</p> </div>	<div style="display: flex; justify-content: space-between;"> <div style="text-align: center;">  <p>VOLVO</p> </div> <div style="text-align: center;">  <p>ATE</p> </div> </div> <div style="text-align: center; margin-top: 20px;">  <p><b>2x</b></p> <p>23590 19,5</p> <p>155,1 x 72,0 x 19,5</p> </div> <div style="text-align: center; margin-top: 20px;">  <p><b>2x</b></p> <p>23591 18,0</p> <p>156,3 x 71,0 x 18,0</p> </div>



# Illustrations disc brake pads

Illustrations plaquettes de frein à disque / Illustrazioni pastiglie freno /  
 Figuras Calços do travão de disco / Rysunki okładzin hamulców tarczowych /  
 Zobrazení obložení kotoučových brzd

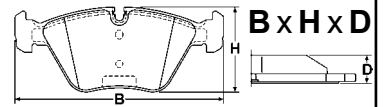

scale - échelle - scala - escala - skala - měřítko 1:2

B1.G102-0696.2 G1020696	B1.G102-0698.2 G1020698
-------------------------	-------------------------



VOLVO



ATE

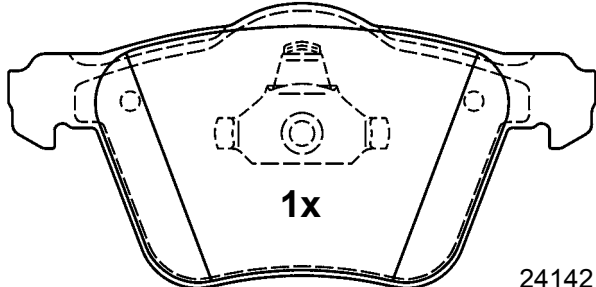

1x

24142 20,6

155,1 x 75,1 x 20,6

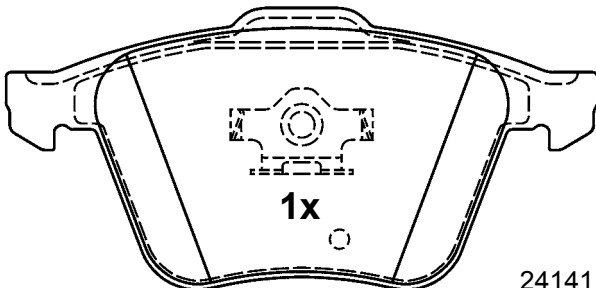

1x

24141 19,1

156,3 x 74,1 x 19,1

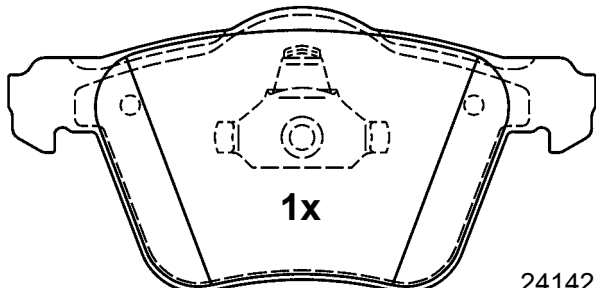

1x

24142 20,6

155,1 x 75,1 x 20,6

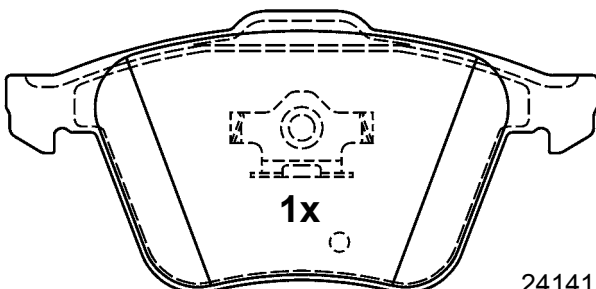

1x

24141 19,1

156,3 x 74,1 x 19,1



VOLKSWAGEN



ATE

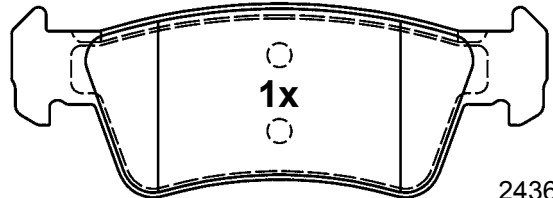

1x

24367 19,1

141,3 x 50,9 x 19,1

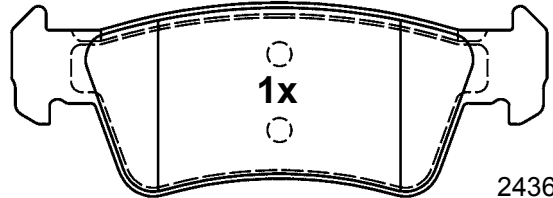

1x

24367 19,1

141,3 x 50,9 x 19,1

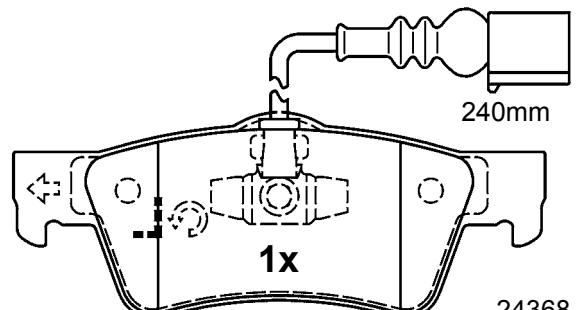

240mm

1x

24368 19,1

140,7 x 53,9 x 19,1

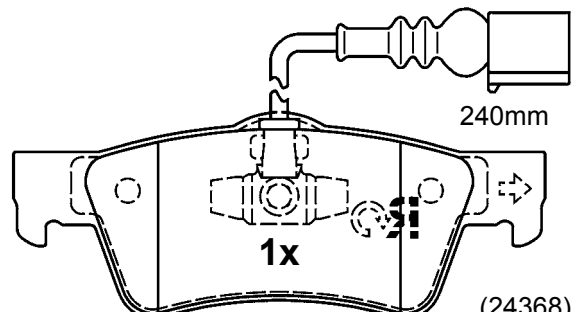

240mm

1x

(24368) 19,1

140,7 x 53,9 x 19,1

# Illustrations disc brake pads

Illustrations plaquettes de frein à disque / Illustrazioni pastiglie freno /  
Figuras Calços do travão de disco / Rysunki okładzin hamulców tarczowych /  
Zobrazení obložení kotoučových brzd

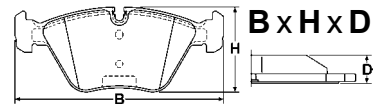

scale - échelle - scala - escala - skala - měřítko 1:2

## B1.G102-0699.2 G1020699



VOLKSWAGEN



ATE

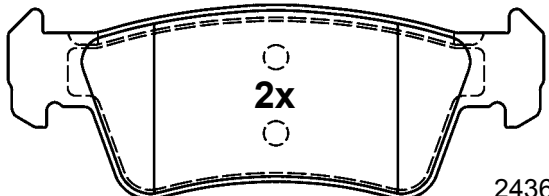

2x

141,3 x 50,9 x 19,1

24367 19,1

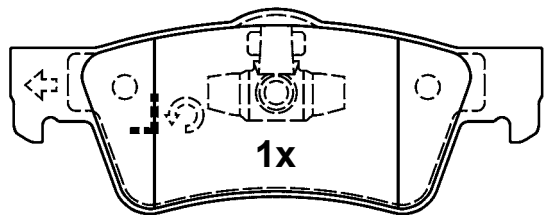

1x

140,7 x 53,9 x 19,1

19,1

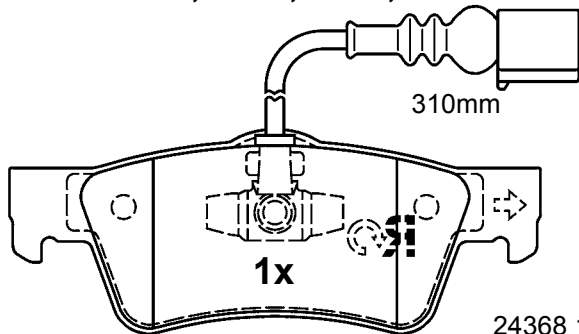

310mm

1x

140,7 x 53,9 x 19,1

24368 19,1

## B1.G102-0704.2 G1020704



VOLKSWAGEN



ATE

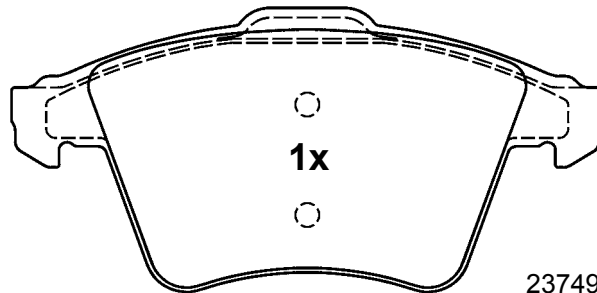

1x

156,2 x 74,8 x 19,1

23749 19,1

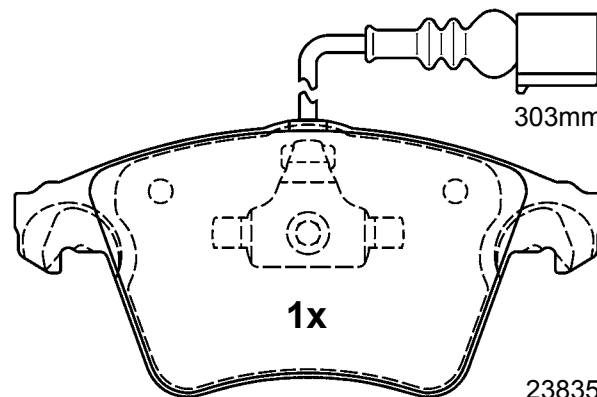

303mm

1x

155,0 x 73,3 x 19,6

23835 19,6

## B1.G102-0701.2 G1020701



ALFA ROMEO



LUC

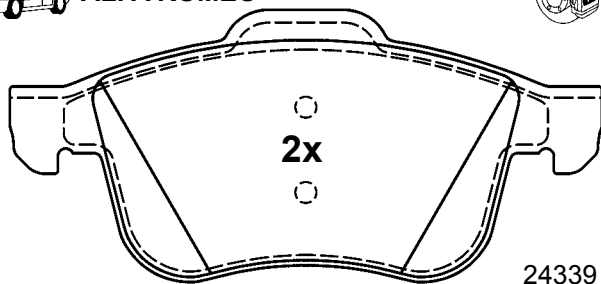

2x

156,3 x 71,5 x 20,5

24339 20,5

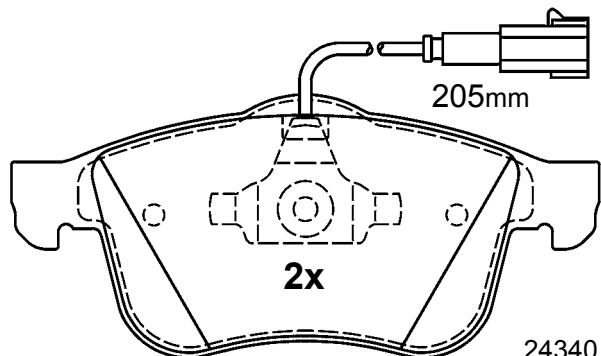

205mm

2x

155,1 x 69,0 x 20,3

24340 20,3

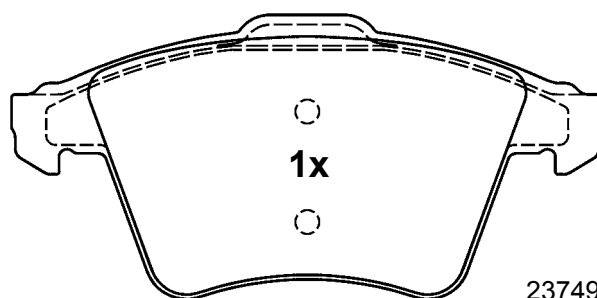

1x

156,2 x 74,8 x 19,1

23749 19,1

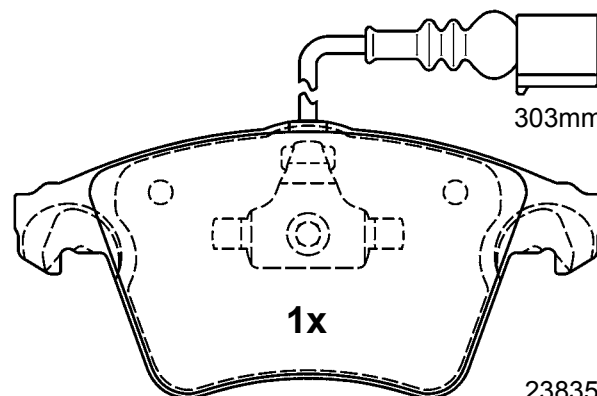

303mm

1x

155,0 x 73,3 x 19,6

23835 19,6



# Illustrations disc brake pads

Illustrations plaquettes de frein à disque / Illustrazioni pastiglie freno /  
 Figuras Calços do travão de disco / Rysunki okładzin hamulców tarczowych /  
 Zobrazení obložení kotoučových brzd

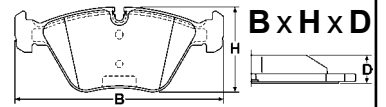

scale - échelle - scala - escala - skala - měřítko 1:2

<b>B1.G102-0706.2 G1020706</b>	<b>B1.G102-0707.2 G1020707</b>
--------------------------------	--------------------------------



VOLKSWAGEN



ATE



VOLKSWAGEN



ATE

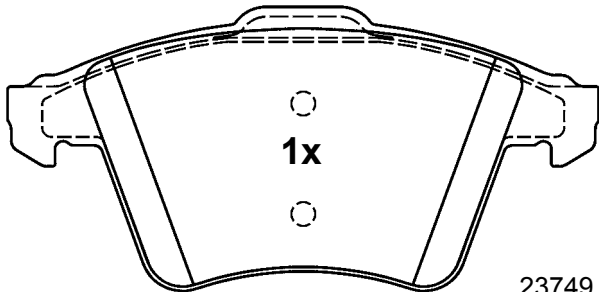

1x

156,2 x 74,8 x 17,6

23749 17,6

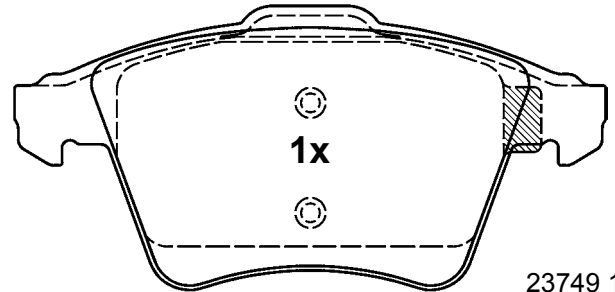

1x

156,2 x 74,8 x 18,7

23749 18,7

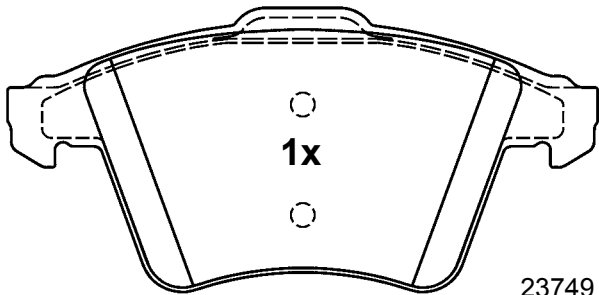

1x

156,2 x 74,8 x 17,6

23749 17,6

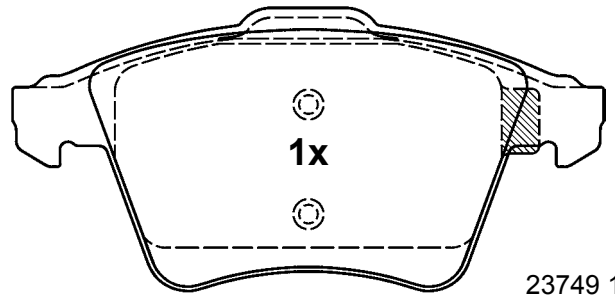

1x

156,2 x 74,8 x 18,7

23749 18,7

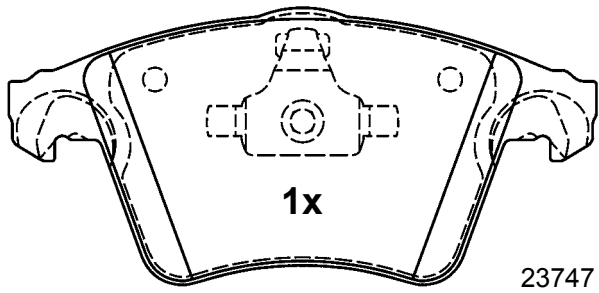

1x

155,0 x 73,3 x 18,1

23747 18,1

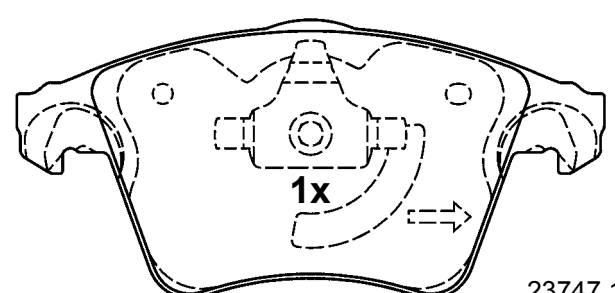

1x

155,0 x 73,3 x 19,7

23747 19,7

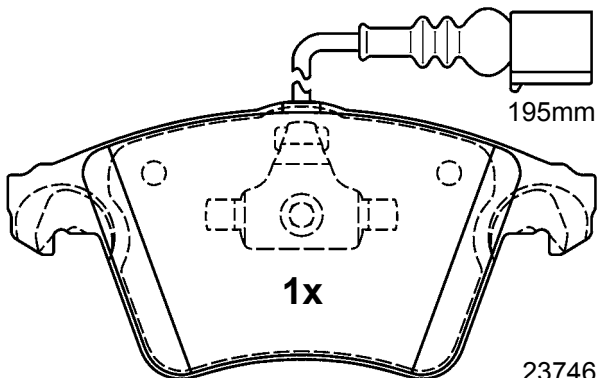

195mm

1x

155,0 x 73,3 x 18,1

23746 18,1

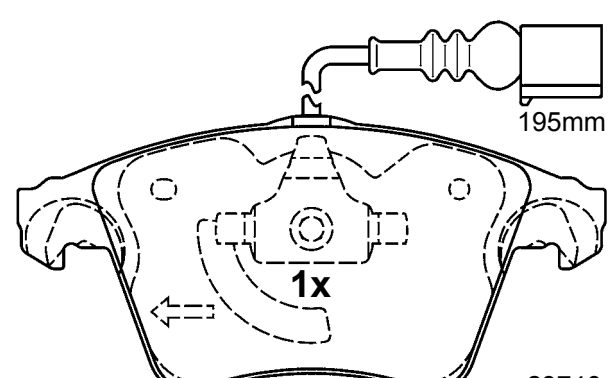

195mm

1x

15501 x 73,3 x 19,7

23746 19,7

# Illustrations disc brake pads

Illustrations plaquettes de frein à disque / Illustrazioni pastiglie freno /  
 Figuras Calços do travão de disco / Rysunki okładzin hamulców tarczowych /  
 Zobrazení obložení kotoučových brzd

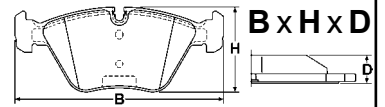

scale - échelle - scala - escala - skala - měřítko 1:2

<b>B1.G102-0709.2 G1020709</b>	<b>B1.G102-0711.2 G1020711</b>
<div style="display: flex; justify-content: space-between; align-items: center;"> <div data-bbox="71 324 183 380"> </div> <div data-bbox="199 331 542 369"> <b>PORSCHE, VOLKSWAGEN</b> </div> <div data-bbox="646 324 726 380"> </div> <div data-bbox="726 331 790 369"> <b>BRE</b> </div> </div> <div style="text-align: center; margin-top: 20px;"> <p data-bbox="638 851 782 884">23692 16,6</p> <p data-bbox="295 1019 550 1064"><b>190 x 99,4 x 16,6</b></p> </div>	<div style="display: flex; justify-content: space-between; align-items: center;"> <div data-bbox="813 324 925 380"> </div> <div data-bbox="941 331 1364 369"> <b>AUDI, PORSCHE, VOLKSWAGEN</b> </div> <div data-bbox="1388 324 1468 380"> </div> <div data-bbox="1476 331 1540 369"> <b>BRE</b> </div> </div> <div style="text-align: center; margin-top: 20px;"> <p data-bbox="1380 772 1524 806">23694 16,7</p> <p data-bbox="1029 1019 1308 1064"><b>112,0 x 73,0 x 16,7</b></p> </div>
<div style="display: flex; justify-content: space-between; align-items: center;"> <div data-bbox="71 1164 183 1220"> </div> <div data-bbox="199 1171 622 1209"> <b>AUDI, PORSCHE, VOLKSWAGEN</b> </div> <div data-bbox="646 1164 726 1220"> </div> <div data-bbox="726 1171 790 1209"> <b>BRE</b> </div> </div> <div style="text-align: center; margin-top: 20px;"> <p data-bbox="638 1780 782 1814">23693 16,6</p> <p data-bbox="271 2072 574 2116"><b>190,0 x 106,4 x 16,6</b></p> </div>	<div style="display: flex; justify-content: space-between; align-items: center;"> <div data-bbox="813 1164 925 1220"> </div> <div data-bbox="941 1171 1053 1209"> <b>TOYOTA</b> </div> <div data-bbox="1388 1164 1468 1220"> </div> <div data-bbox="1476 1171 1540 1209"> <b>LUC</b> </div> </div> <div style="text-align: center; margin-top: 20px;"> <p data-bbox="1380 1422 1524 1456">23766 17,8</p> <p data-bbox="1380 1691 1524 1724">23818 17,8</p> <p data-bbox="1380 1982 1524 2016">23819 17,8</p> <p data-bbox="1029 2072 1308 2116"><b>131,5 x 57,3 x 17,8</b></p> </div>



# Illustrations disc brake pads

Illustrations plaquettes de frein à disque / Illustrazioni pastiglie freno /

Figuras Calços do travão de disco / Rysunki okładzin hamulców tarczowych /

Zobrazení obložení kotoučových brzd

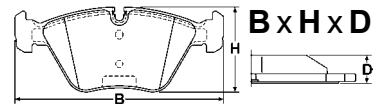

scale - échelle - scala - escala - skala - měřítko 1:2

## B1.G102-0713.2 G1020713



TOYOTA



LUC

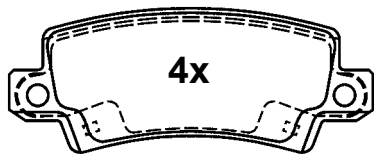

4x

23816 16,0

95,6 x 37,9 x 16,0



2x

## B1.G102-0719.2 G1020719



MAZDA



AKE

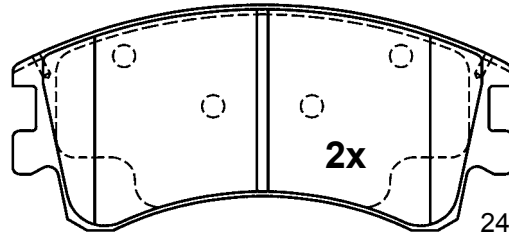

2x

24046 18,6

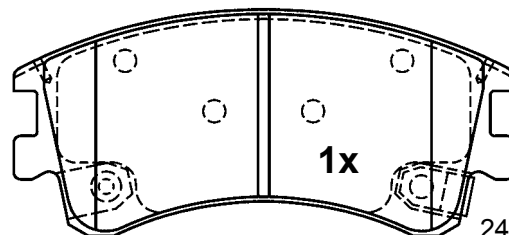

1x

24047 18,6

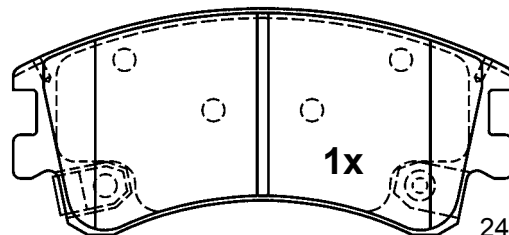

1x

24048 18,6

131,8 x 59,5 x 18,0

## B1.G102-0714.2 G1020714



TOYOTA



AKE

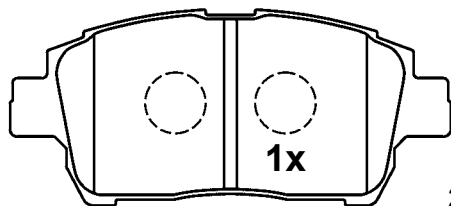

1x

23510 16,5

116,3 x 51,6 x 16,5

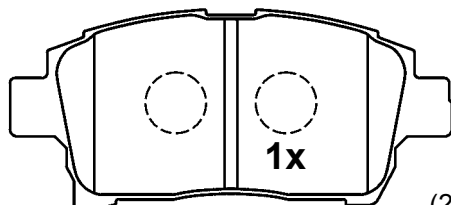

1x

(23510) 16,5

116,5 x 54,5 x 16,5

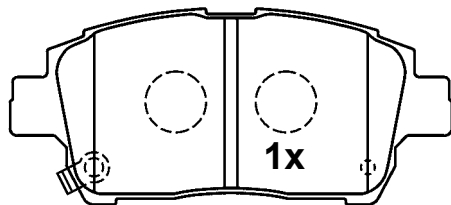

1x

23511 16,5

116,3 x 51,6 x 16,5

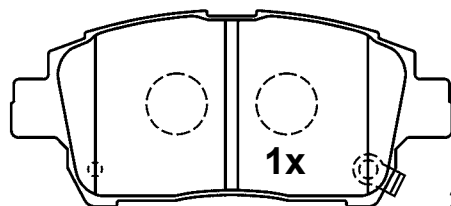

1x

23512 16,5

116,3 x 51,6 x 16,5

## B1.G102-0721.2 G1020721



MAZDA



AKE

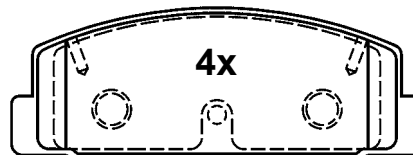

4x

24045 13,7

107,7 x 39,4 x 13,7

# Illustrations disc brake pads

Illustrations plaquettes de frein à disque / Illustrazioni pastiglie freno /  
 Figuras Calços do travão de disco / Rysunki okładzin hamulców tarczowych /  
 Zobrazení obložení kotoučových brzd

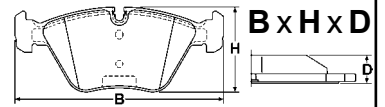

scale - échelle - scala - escala - skala - měřítko 1:2

<b>B1.G102-0722.2 G1020722</b>	<b>B1.G102-0730.2 G1020730</b>
--------------------------------	--------------------------------

**HONDA** **SUM**

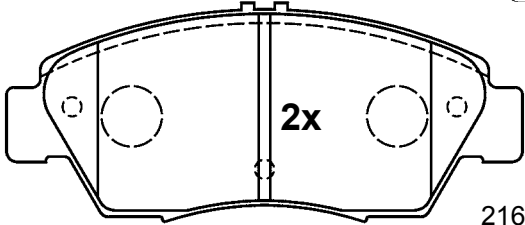

21694 16,3

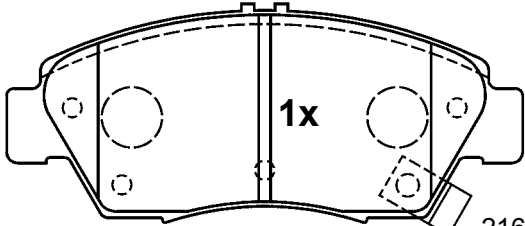

21696 16,3

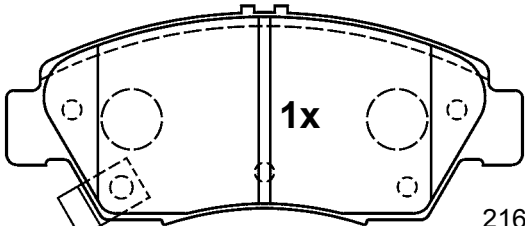

21695 16,3

**136,5 x 57,4 x 16,3**

**CITROEN, FIAT, PEUGEOT** **BRE**

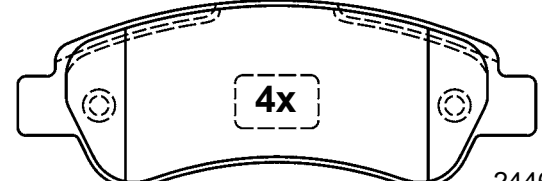

24465 19,2

**136,8 x 48,9 x 19,2**

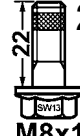

**2x**

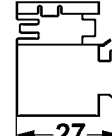

**4x**

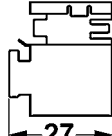

**4x**

**B1.G102-0727.2 G1020727**

**FORD, MAZDA, OPEL, SAAB, VAUXHALL, VOLVO** **ATE**

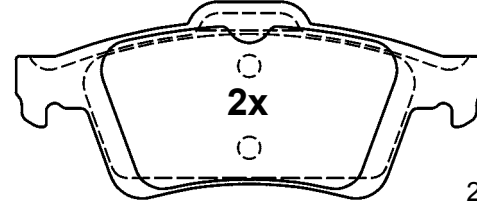

23482 16,6

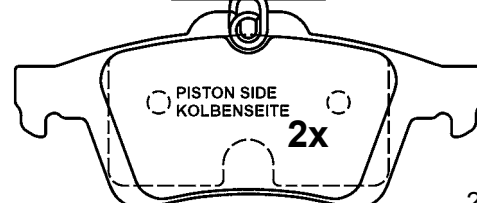

24137 16,6

**123,0 x 52,0 x 16,6**

PISTON SIDE  
KOLBENSEITE

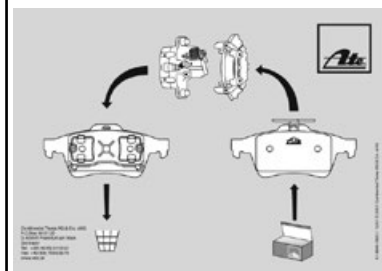

**B1.G102-0732.2 G1020732**

**SEAT, SKODA, VOLKSWAGEN** **LUC**

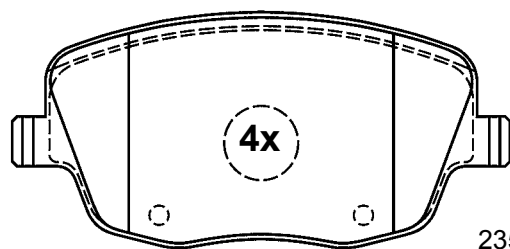

23581 18,8



**2x**

**M8x22**

**131,4 x 62,0 x 18,8**



# Illustrations disc brake pads

Illustrations plaquettes de frein à disque / Illustrazioni pastiglie freno /  
Figuras Calços do travão de disco / Rysunki okładzin hamulców tarczowych /  
Zobrazení obložení kotoučových brzd

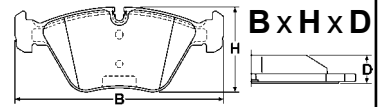

scale - échelle - scala - escala - skala - měřítko 1:2

## B1.G102-0733.2 G1020733



SEAT, SKODA, VOLKSWAGEN



LUC

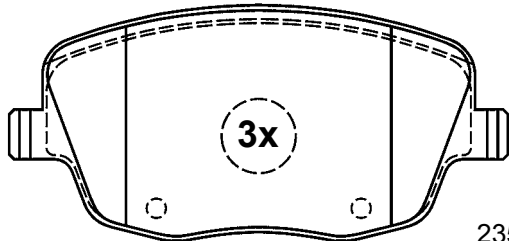

23581 18,8

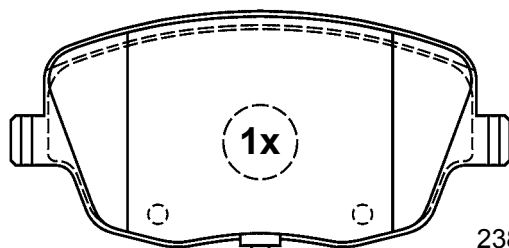

23843 18,8

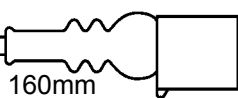

160mm

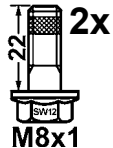

M8x1

131,4 x 62,0 x 18,8

## B1.G102-0734.2 G1020734



AUDI, SEAT, SKODA,  
VOLKSWAGEN



LUC

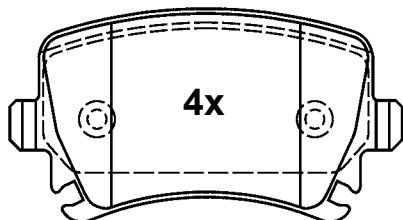

23914 17,1

105,3 x 55,9 x 17,1



M8x21

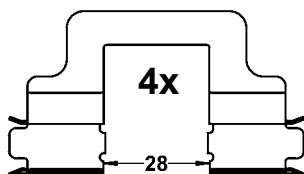

4x

28

## B1.G102-0735.2 G1020735



CITROEN, PEUGEOT



BOS

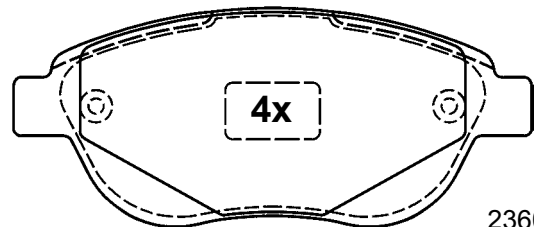

23600 19,4

136,8 x 57,5 x 19,4

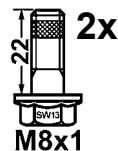

2x

M8x1

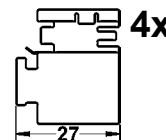

4x

27

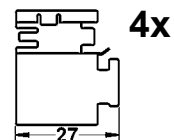

4x

27

## B1.G102-0737.2 G1020737



ALFA ROMEO, FIAT



BOS

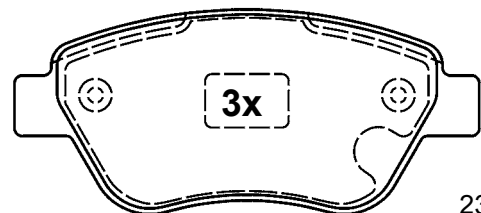

23707 18,0

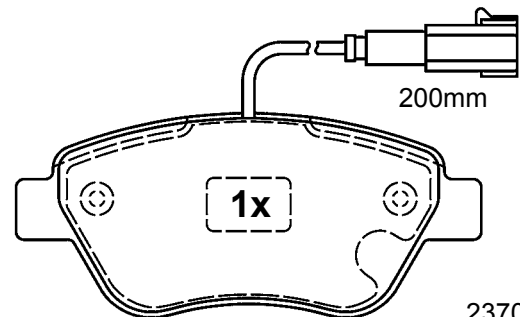

200mm

23706 18,0

122,8 x 53,3 x 18,0

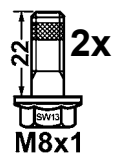

2x

M8x1

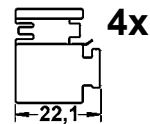

4x

22,1

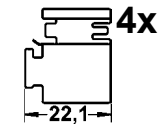

4x

22,1

# Illustrations disc brake pads

Illustrations plaquettes de frein à disque / Illustrazioni pastiglie freno /  
 Figuras Calços do travão de disco / Rysunki okładzin hamulców tarczowych /  
 Zobrazení obložení kotoučových brzd

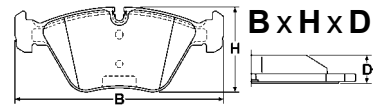

scale - échelle - scala - escala - skala - měřítko 1:2

<b>B1.G102-0738.2 G1020738</b>	<b>B1.G102-0741.2 G1020741</b>
--------------------------------	--------------------------------

**FIAT, LANCIA**

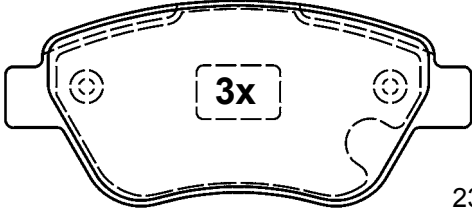

23710 19,0

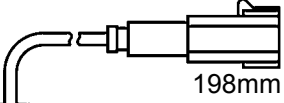

198mm

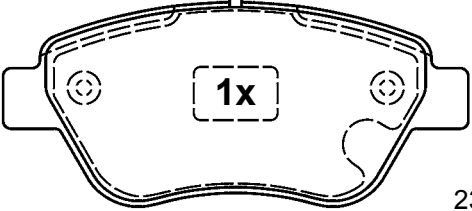

23709 19,0

**136,8 x 57,4 x 19,0**

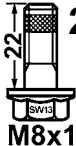
  
**2x**  
 M8x1

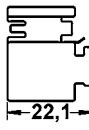
  
**4x**  
 -22,1-

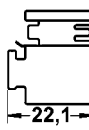
  
**4x**  
 -22,1-

**DACIA, MERCEDES BENZ, NISSAN, RENAULT**

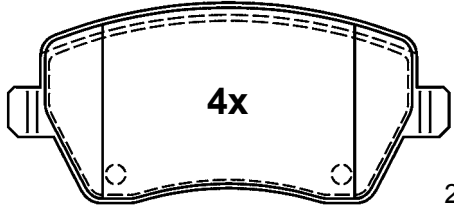

23973 17,1

**116,3 x 52,4 x 17,1**

  
**2x**  
 M8x21

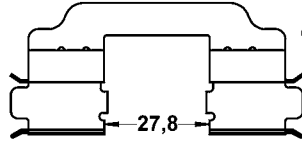
  
**4x**  
 27,8

**B1.G102-0740.2 G1020740**

**CITROEN, FIAT, LANCIA, PEUGEOT**

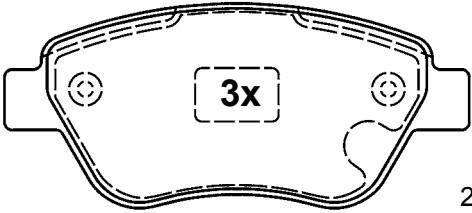

23707 18,0

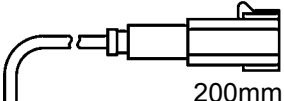

200mm

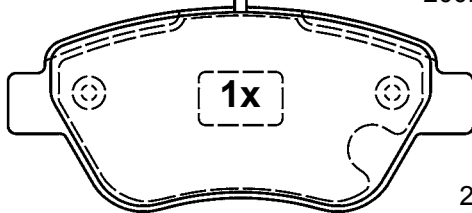

23706 18,0

**122,8 x 53,3 x 18,0**

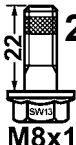
  
**2x**  
 M8x1

**B1.G102-0742.2 G1020742**

**MERCEDES BENZ, VOLKSWAGEN**

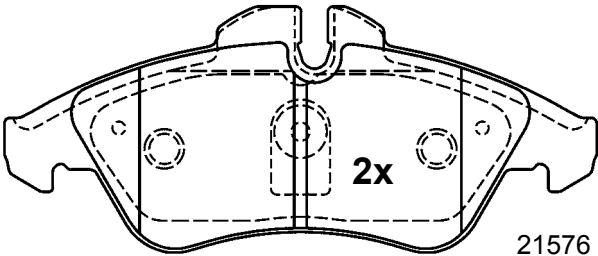

21576 20,7

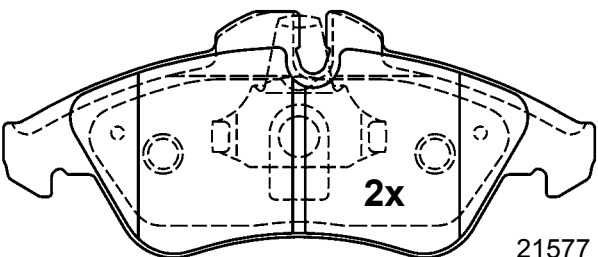

21577 20,7

**156,3 x 64,8 x 20,7**



# Illustrations disc brake pads

Illustrations plaquettes de frein à disque / Illustrazioni pastiglie freno /  
 Figuras Calços do travão de disco / Rysunki okładzin hamulców tarczowych /  
 Zobrazení obložení kotoučových brzd

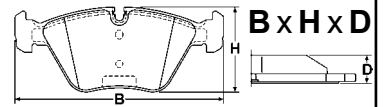

scale - échelle - scala - escala - skala - měřítko 1:2

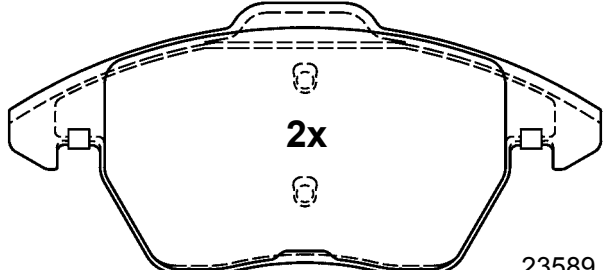
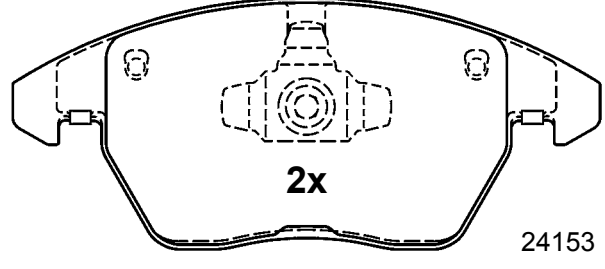
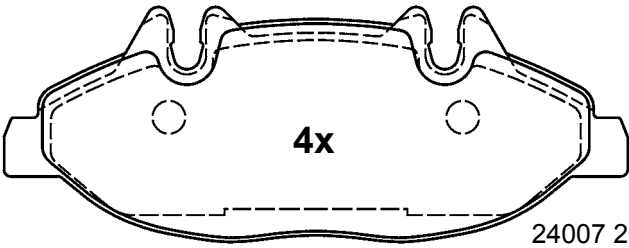
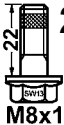
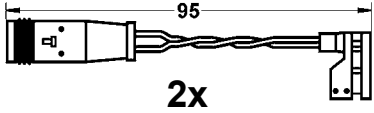
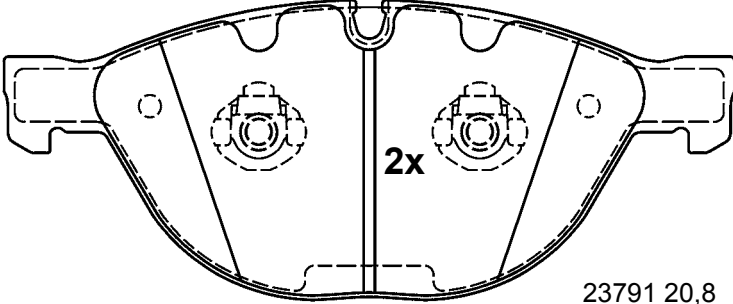
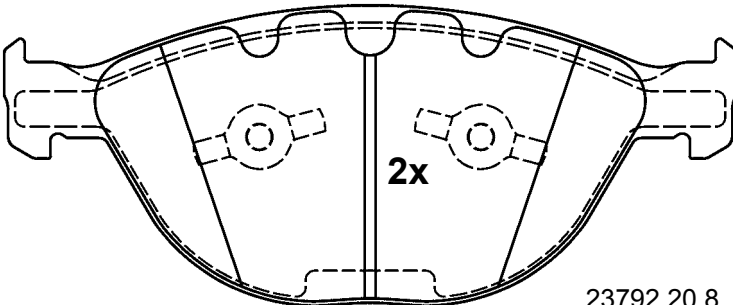
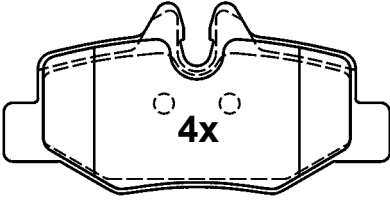
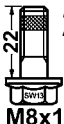
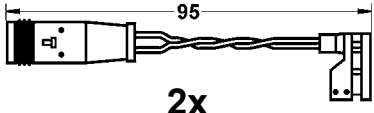
<b>B1.G102-0745.2 G1020745</b>	<b>B1.G102-0751.2 G1020751</b>
<div style="display: flex; justify-content: space-between;"> <div data-bbox="71 324 470 380">  CITROEN, PEUGEOT                 </div> <div data-bbox="646 324 782 380">  ATE                 </div> </div> <div style="text-align: center; margin-top: 20px;">  <p><b>2x</b></p> <p>23589 19,1</p> <p><b>156,3 x 71,3 x 19,1</b></p>  <p><b>2x</b></p> <p>24153 19,1</p> <p><b>155,1 x 66,0 x 19,1</b></p> </div>	<div style="display: flex; justify-content: space-between;"> <div data-bbox="813 324 1181 380">  MERCEDES BENZ                 </div> <div data-bbox="1396 324 1532 380">  BOS                 </div> </div> <div style="text-align: center; margin-top: 20px;">  <p><b>4x</b></p> <p>24007 20,8</p> <p><b>164,8 x 61,8 x 20,8</b></p> <div style="display: flex; justify-content: space-around; margin-top: 20px;"> <div data-bbox="821 1030 925 1153">  <p><b>2x</b></p> <p>M8x1</p> </div> <div data-bbox="981 1019 1356 1131">  <p>95</p> <p><b>2x</b></p> </div> </div> </div>
<b>B1.G102-0746.2 G1020746</b>	<b>B1.G102-0752.2 G1020752</b>
<div style="display: flex; justify-content: space-between;"> <div data-bbox="71 1265 271 1321">  BMW                 </div> <div data-bbox="646 1265 782 1321">  ATE                 </div> </div> <div style="text-align: center; margin-top: 20px;">  <p><b>2x</b></p> <p>23791 20,8</p>  <p><b>2x</b></p> <p>23792 20,8</p> <p><b>193,0 x 79,0 x 20,8</b></p> </div>	<div style="display: flex; justify-content: space-between;"> <div data-bbox="813 1265 1181 1321">  MERCEDES BENZ                 </div> <div data-bbox="1396 1265 1532 1321">  BOS                 </div> </div> <div style="text-align: center; margin-top: 20px;">  <p><b>4x</b></p> <p>24008 18,3</p> <p><b>101,8 x 50,2 x 18,3</b></p> <div style="display: flex; justify-content: space-around; margin-top: 20px;"> <div data-bbox="821 1982 925 2105">  <p><b>2x</b></p> <p>M8x1</p> </div> <div data-bbox="981 1892 1356 2004">  <p>95</p> <p><b>2x</b></p> </div> </div> </div>

# Illustrations disc brake pads

Illustrations plaquettes de frein à disque / Illustrazioni pastiglie freno /  
Figuras Calços do travão de disco / Rysunki okładzin hamulców tarczowych /  
Zobrazení obložení kotoučových brzd

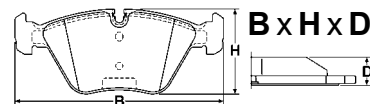

scale - échelle - scala - escala - skala - měřítko 1:2

## B1.G102-0753.2 G1020753



AUDI, SKODA, VOLKSWAGEN



ATE

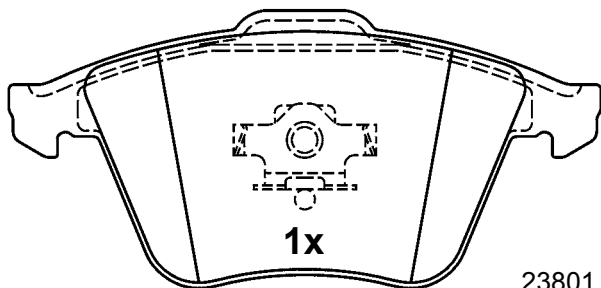

1x

23801 20,3

156,3 x 72,9 x 20,3

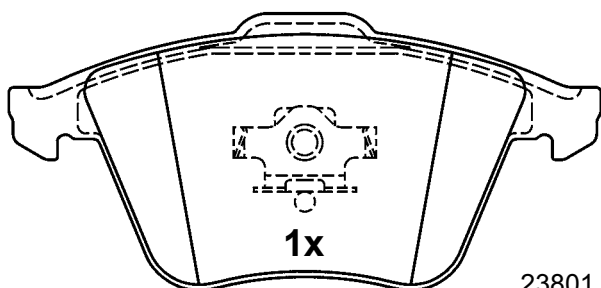

1x

23801 20,3

156,3 x 72,9 x 20,3

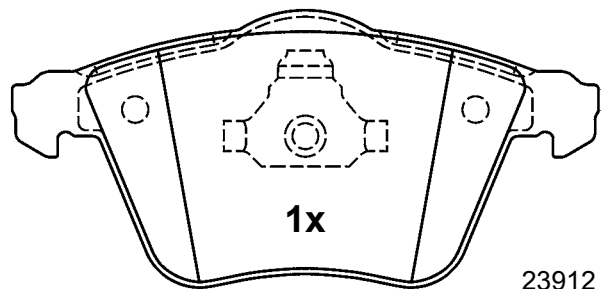

1x

23912 20,3

155,1 x 72,9 x 20,3

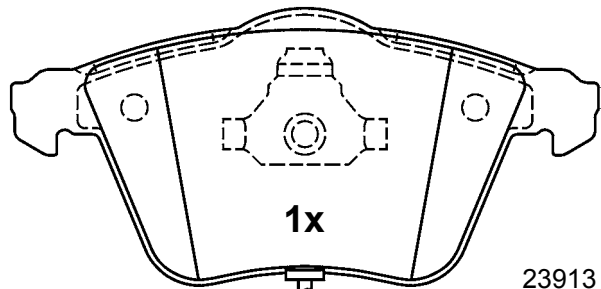

1x

23913 20,3

177,5mm

155,1 x 72,9 x 20,3

## B1.G102-0754.2 G1020754



AUDI, SEAT



ATE

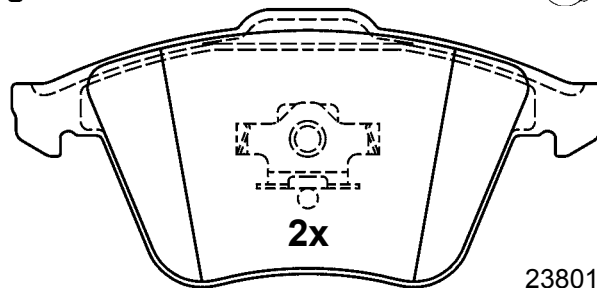

2x

23801 20,3

156,3 x 72,9 x 20,3

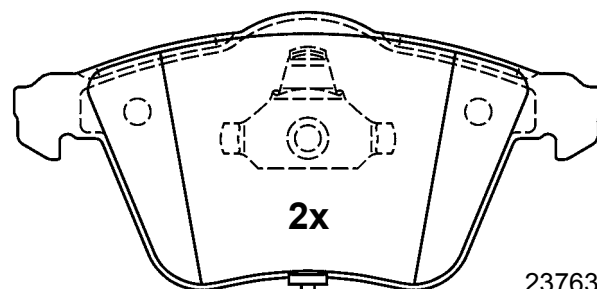

2x

23763 20,3

242,5mm

155,1 x 72,9 x 20,3

## B1.G102-0755.2 G1020755



AUDI, SEAT, SKODA  
VOLKSWAGEN



LUC

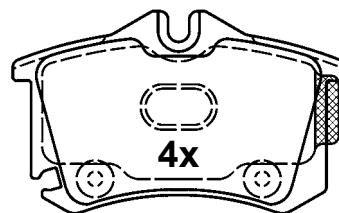

4x

20961 17,1

87,2 x 52,9 x 17,1



2x

M8x22

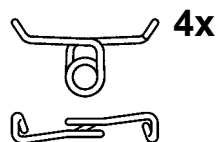

4x

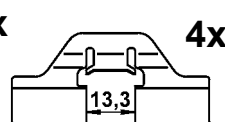

4x



# Illustrations disc brake pads

Illustrations plaquettes de frein à disque / Illustrazioni pastiglie freno /  
Figuras Calços do travão de disco / Rysunki okładzin hamulców tarczowych /  
Zobrazení obložení kotoučových brzd

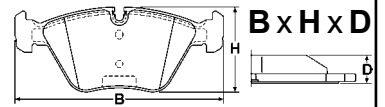

scale - échelle - scala - escala - skala - měřítko 1:2

## B1.G102-0756.2 G1020756



OPEL, SAAB, VAUXHALL



ATE

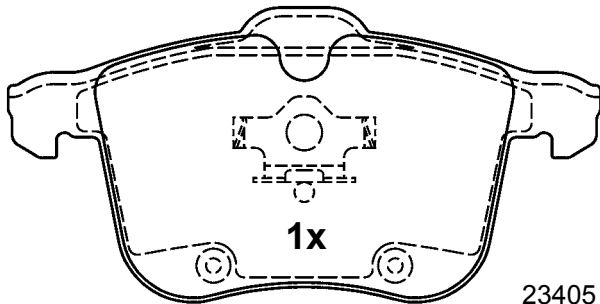

1x

23405 20,1

156,4 x 77,6 x 20,1

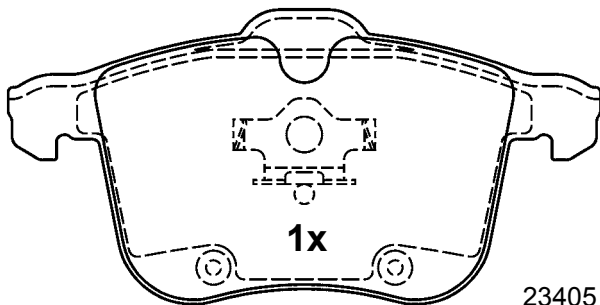

1x

23405 20,1

156,4 x 77,6 x 20,1

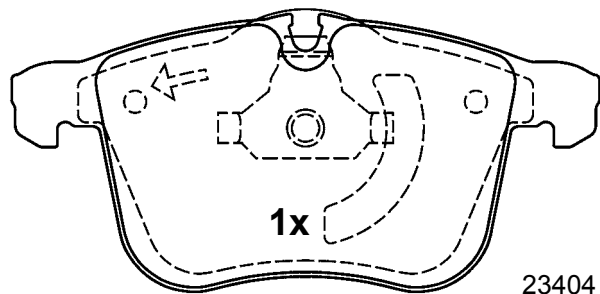

1x

23404 20,6

155,1 x 74,5 x 20,6

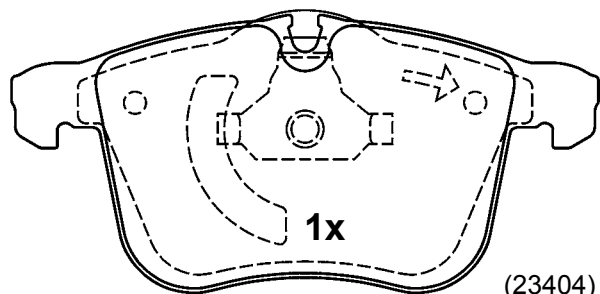

1x

(23404) 20,6

155,1 x 74,5 x 20,6

## B1.G102-0758.2 G1020758



AUDI



LUC

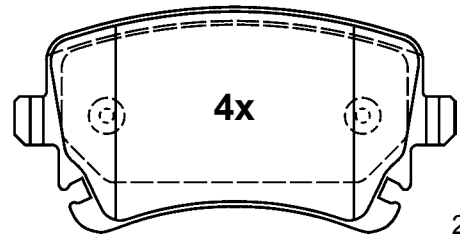

4x

23326 17,4

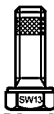

2x

M8x21

116,1 x 59,0 x 17,4

## B1.G102-0759.2 G1020759



AUDI



LUC

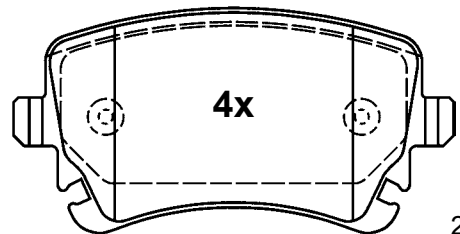

4x

23326 17,4

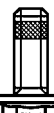

2x

M8x22

116,1 x 59,0 x 17,4

# Illustrations disc brake pads

Illustrations plaquettes de frein à disque / Illustrazioni pastiglie freno /  
 Figuras Calços do travão de disco / Rysunki okładzin hamulców tarczowych /  
 Zobrazení obložení kotoučových brzd

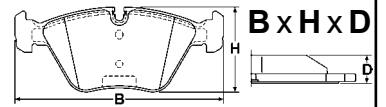

scale - échelle - scala - escala - skala - měřítko 1:2

<b>B1.G102-0761.2 G1020761</b>	<b>B1.G102-0762.2 G1020762</b>
--------------------------------	--------------------------------



PEUGEOT



LUC

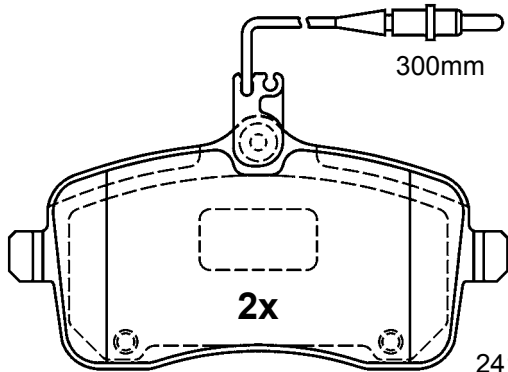

24134 19,6

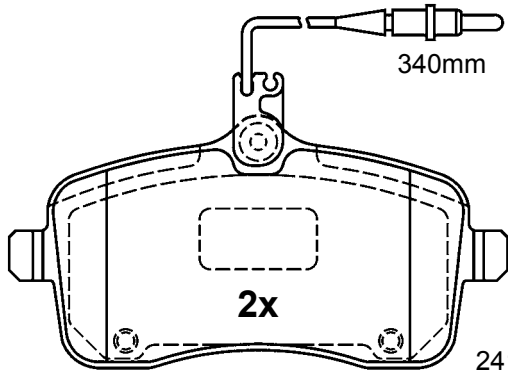

24175 19,6



M8x21

131,4 x 67,5 x 19,6



CITROEN, PEUGEOT



LUC

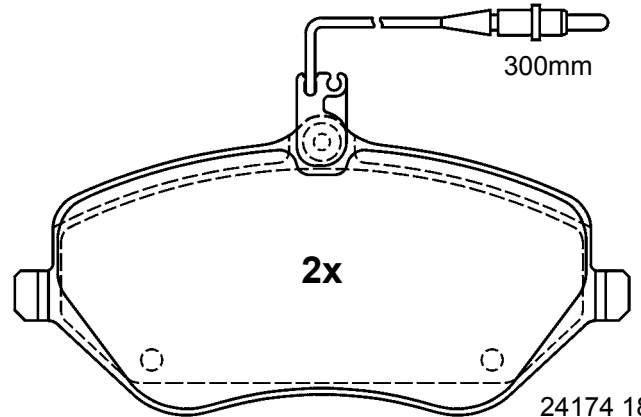

24174 18,6

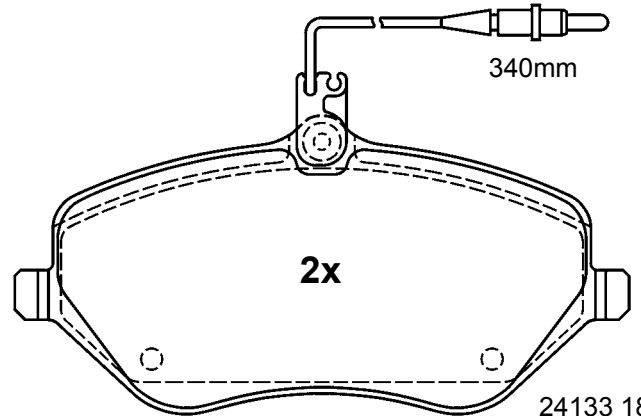

24133 18,6

162,3 x 79,0 18,6



M8x21

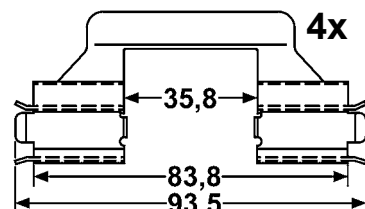

# Illustrations disc brake pads

Illustrations plaquettes de frein à disque / Illustrazioni pastiglie freno /  
 Figuras Calços do travão de disco / Rysunki okładzin hamulców tarczowych /  
 Zobrazení obložení kotoučových brzd

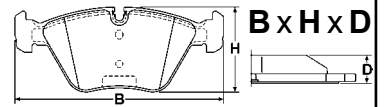

scale - échelle - scala - escala - skala - měřítko 1:2

## B1.G102-0763.2 G1020763



CITROEN, FIAT, PEUGEOT



BRE

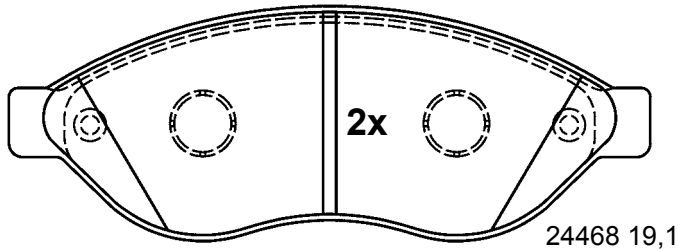

24468 19,1

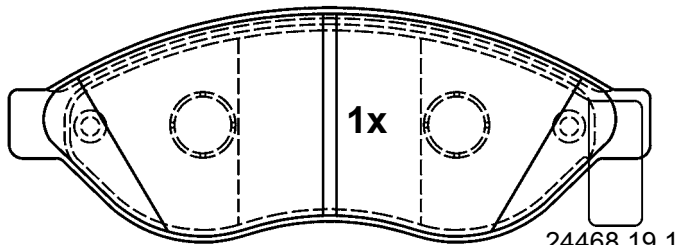

24468 19,1

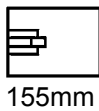

155mm

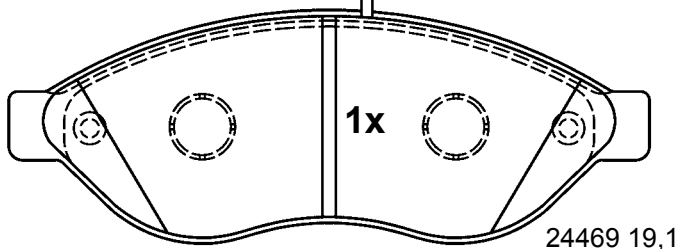

24469 19,1

169,2 x 61,5 x 19,1

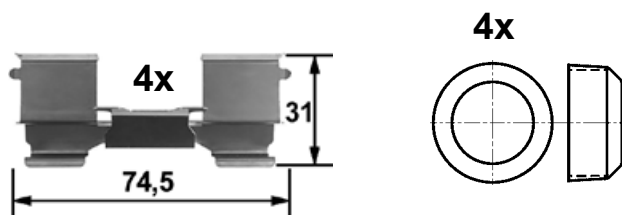

4x

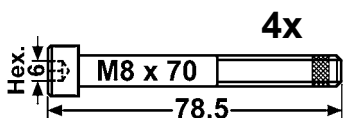

4x

## B1.G102-0764.2 G1020764



CITROEN, FIAT, PEUGEOT



BRE

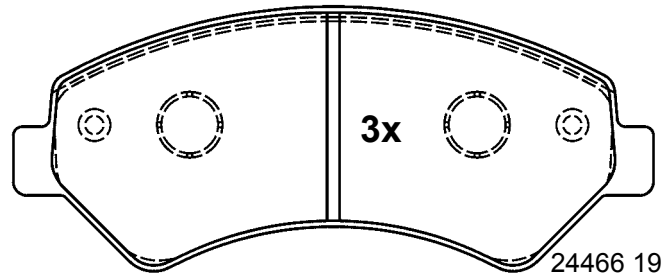

24466 19,1

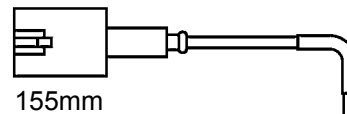

155mm

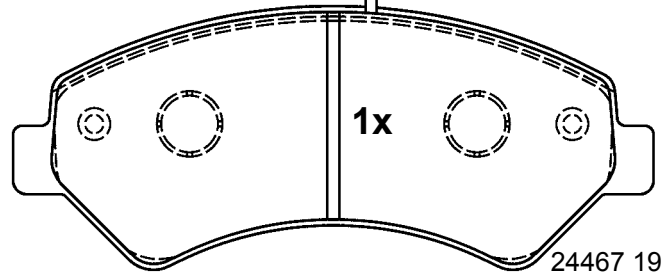

24467 19,1

169,2 x 69,1 x 19,1

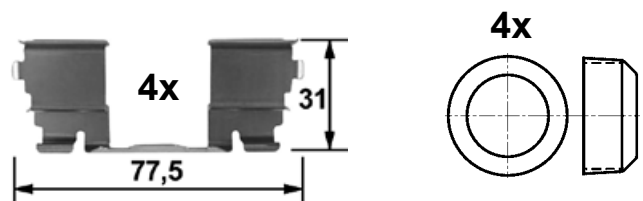

4x

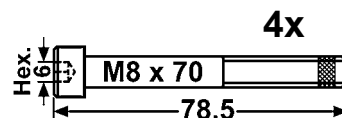

4x

# Illustrations disc brake pads

Illustrations plaquettes de frein à disque / Illustrazioni pastiglie freno /  
Figuras Calços do travão de disco / Rysunki okładzin hamulców tarczowych /  
Zobrazení obložení kotoučových brzd

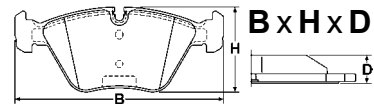

scale - échelle - scala - escala - skala - měřítko 1:2

## B1.G102-0765.2 G1020765



OPEL, VAUXHALL



ATE

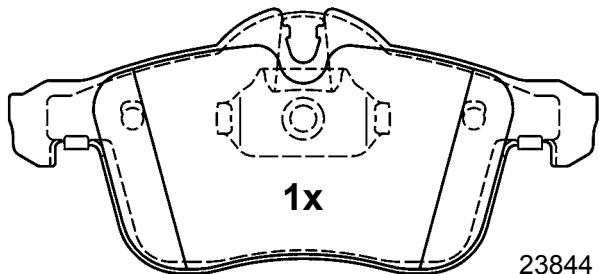

1x

23844 20,5

155,1 x 69,7 x 20,5

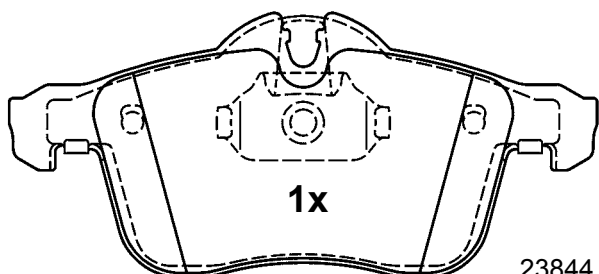

1x

23844 20,5

155,1 x 69,7 x 20,5

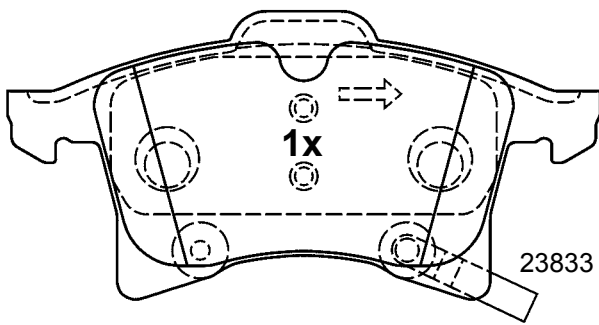

1x

23833 20,2

156,3 x 76,0 x 20,2

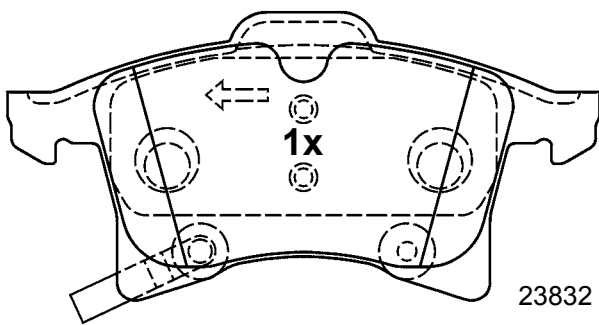

1x

23832 20,2

156,3 x 76,0 x 20,2

## B1.G102-0766.2 G1020766



VOLKSWAGEN



BOS

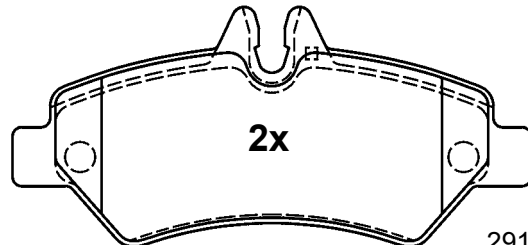

2x

29190 20,2

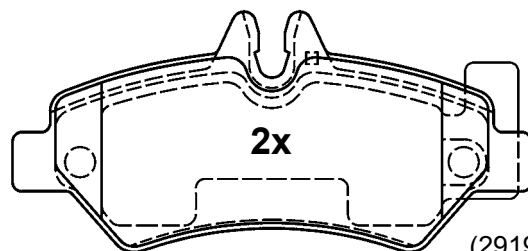

2x

(29190) 20,2

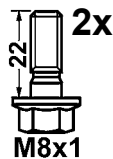

2x

M8x1

136,8 x 63,0 x 20,2

## B1.G102-0768.2 G1020768



TOYOTA



BOS

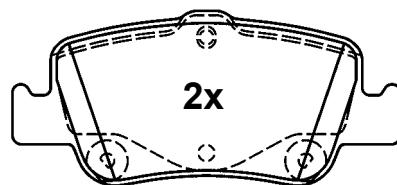

2x

24664 15,2

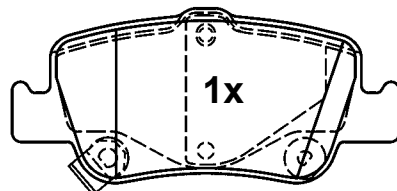

1x

24666 15,2

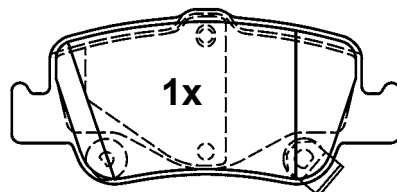

1x

24665 15,2

102,0 x 46,0 x 15,2



4x



4x

# Illustrations disc brake pads

Illustrations plaquettes de frein à disque / Illustrazioni pastiglie freno /  
 Figuras Calços do travão de disco / Rysunki okładzin hamulców tarczowych /  
 Zobrazení obložení kotoučových brzd

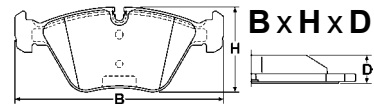

scale - échelle - scala - escala - skala - měřítko 1:2

## B1.G102-0769.2 G1020769

MERCEDES BENZ, VOLKSWAGEN BRE

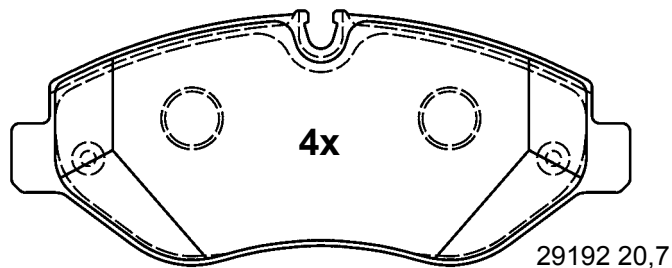

163,3 x 67,0 x 20,7

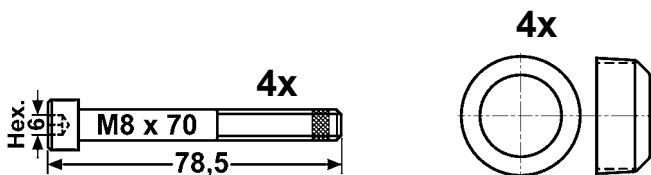

## B1.G102-0772.2 G1020772

FORD, VOLVO, MAZDA ATE

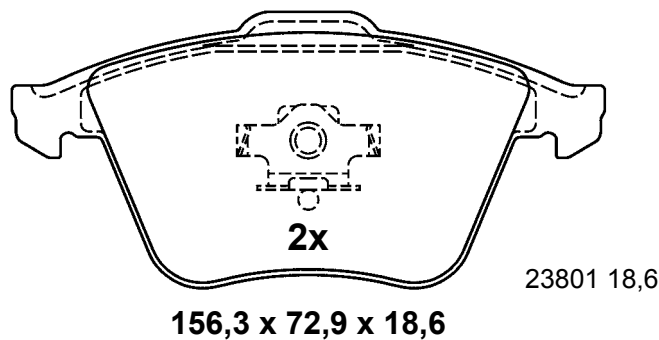
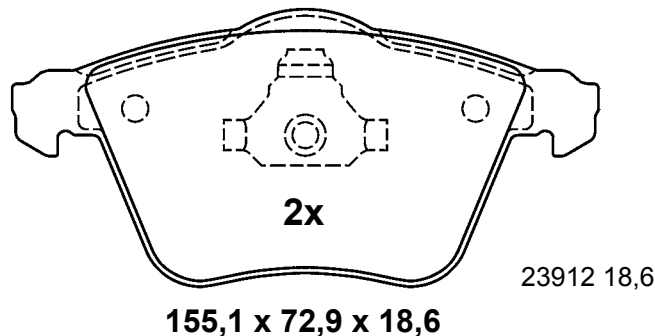

## B1.G102-0770.2 G1020770

MERCEDES BENZ, VOLKSWAGEN BRE

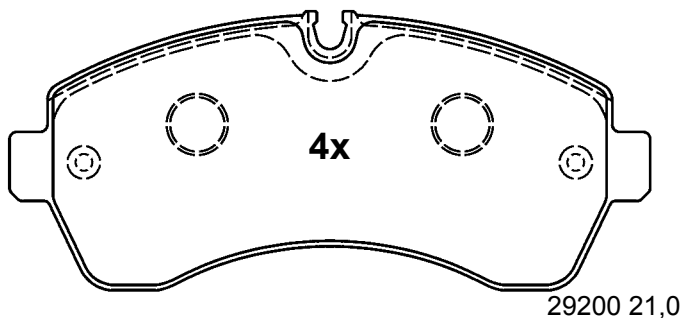

169,1 x 73,4 x 21,0

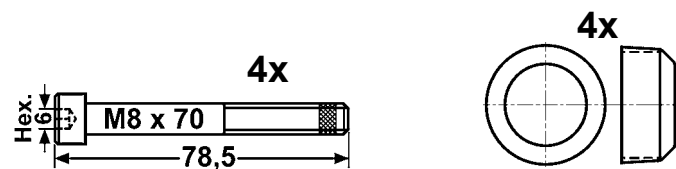

## B1.G102-0774.2 G1020774

FIAT, SUZUKI LUC

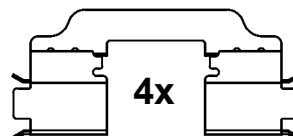
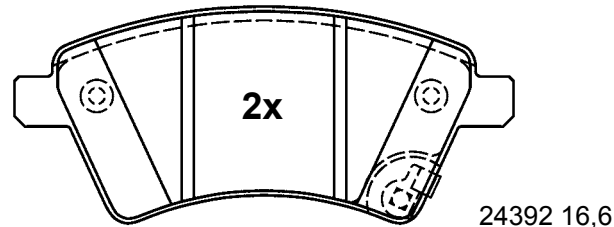
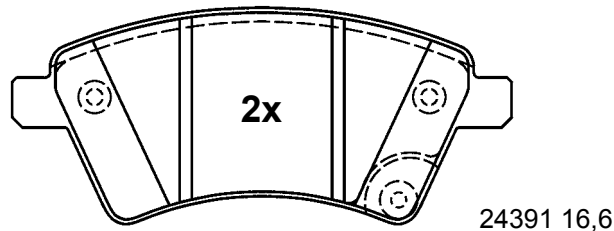

# Illustrations disc brake pads

Illustrations plaquettes de frein à disque / Illustrazioni pastiglie freno /  
 Figuras Calços do travão de disco / Rysunki okładzin hamulców tarczowych /  
 Zobrazení obložení kotoučových brzd

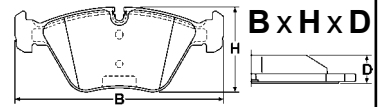

scale - échelle - scala - escala - skala - měřítko 1:2

<b>B1.G102-0776.2 G1020776</b>	<b>B1.G102-0777.2 G1020777</b>
--------------------------------	--------------------------------



MERCEDES BENZ



ATE

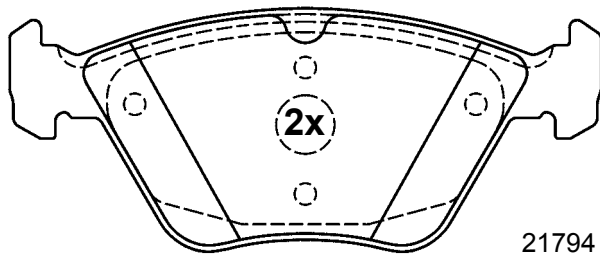

21794 19,3

156,3 x 63,1 x 19,3

2x



RENAULT



BDX

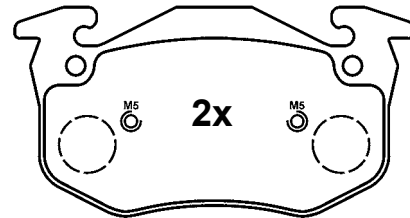

21597 11,0

2x

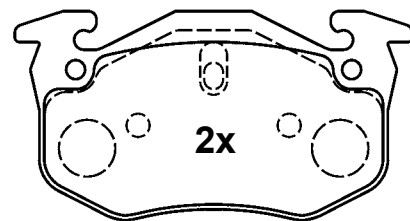

21600 11,0

2x



4x

105,0 x 54,9 x 11,0

<b>B1.G102-0779.2 G1020779</b>
--------------------------------



MITSUBISHI, SMART



LUC

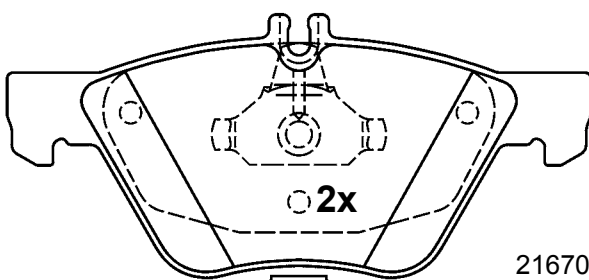

21670 19,3

155,1 x 69,3 x 19,3

2x

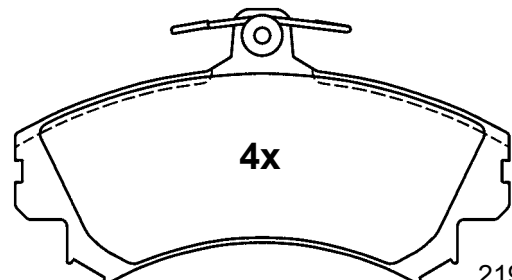

21920 16,6

4x

129,9 x 72,7 x 16,6

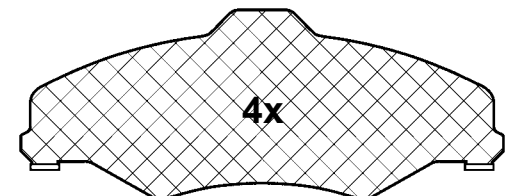

4x



M8x22

1x



# Illustrations disc brake pads

Illustrations plaquettes de frein à disque / Illustrazioni pastiglie freno /  
 Figuras Calços do travão de disco / Rysunki okładzin hamulców tarczowych /  
 Zobrazení obložení kotoučových brzd

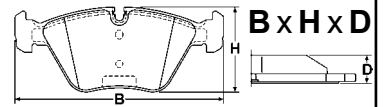

scale - échelle - scala - escala - skala - měřítko 1:2

<b>B1.G102-0780.2 G1020780</b>	<b>B1.G102-0786.2 G1020786</b>
--------------------------------	--------------------------------

MITSUBISHI, SMART

**4x**

21861 15,2

**87,0 x 47,0 x 15,2**

**2x**  
M8x21

**1x**

FORD

**4x**

24537 16,1

**95,1 x 43,2 x 16,1**

**2x**

**2x**

**4x**  
M8x21

**B1.G102-0785.2 G1020785**

PORSCHE

**4x**

23330 17,0

**140,0 x 88,5 x 17,0**

82,5  
88,5

**B1.G102-0787.2 G1020787**

FORD, LAND ROVER, VOLVO

**4x**

24496 17,3

**106,0 x 48,7 x 17,3**

**2x**

18  
54

**2x**

17,7  
57,3







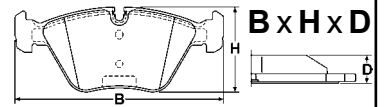



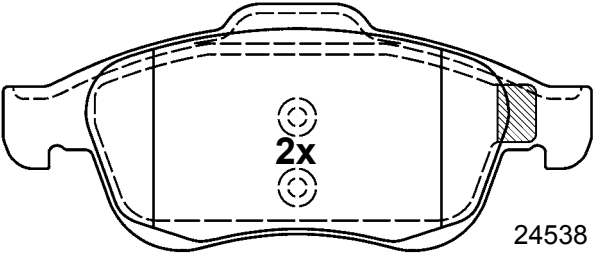
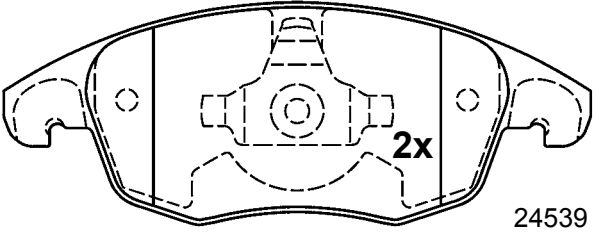

**4x**  
M8x21

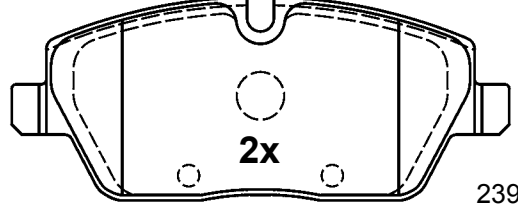
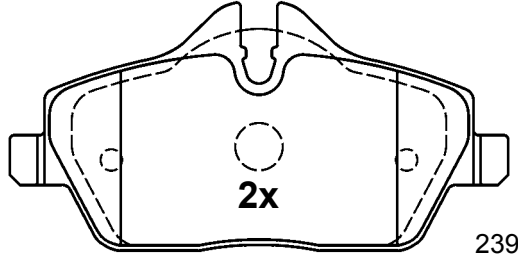
# Illustrations disc brake pads

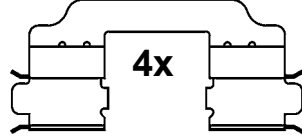
Illustrations plaquettes de frein à disque / Illustrazioni pastiglie freno /  
 Figuras Calços do travão de disco / Rysunki okładzin hamulców tarczowych /  
 Zobrazení obložení kotoučových brzd

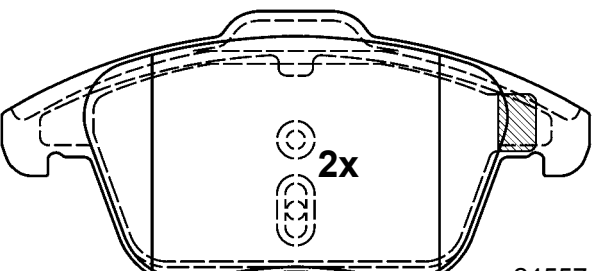
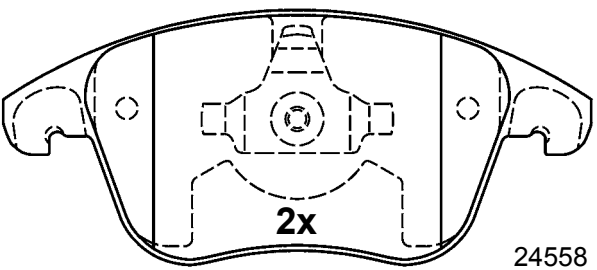

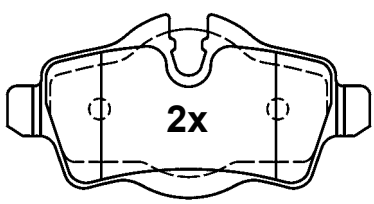
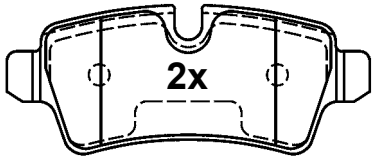
scale - échelle - scala - escala - skala - měřítko 1:2

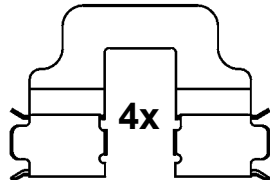
B1.G102-0790.2 G1020790	B1.G102-0794.2 G1020794
<p> CITROEN, PEUGEOT </p>  <p><b>2x</b></p> <p>24538 18,5</p> <p><b>155,1 x 64,7 x 18,5</b></p>  <p><b>2x</b></p> <p>24539 18,5</p> <p><b>155,1 x 58,3 x 18,5</b></p>	<p> BMW, MINI </p>  <p><b>2x</b></p> <p>23915 17,6</p> <p><b>131,3 x 53,2 x 17,6</b></p>  <p><b>2x</b></p> <p>23916 17,6</p> <p><b>131,3 x 65,3 x 17,6</b></p> <p> <b>2x</b> M8x21</p>  <b>4x</b>
B1.G102-0792.2 G1020792	B1.G102-0796.2 G1020796
<p> CITROEN, PEUGEOT </p>  <p><b>2x</b></p> <p>24557 19,4</p> <p><b>155,1 x 72,0 x 19,4</b></p>  <p><b>2x</b></p> <p>24558 18,7</p> <p><b>155,1 x 66,6 x 18,7</b></p>	<p> MINI </p>  <p><b>2x</b></p> <p>24289 16,9</p> <p><b>95,3 x 48,3 x 16,9</b></p>  <p><b>2x</b></p> <p>24290 16,9</p> <p><b>95,3 x 39,0 x 16,9</b></p> <p> <b>2x</b> M8x22</p>  <b>4x</b>



# Illustrations disc brake pads

Illustrations plaquettes de frein à disque / Illustrazioni pastiglie freno /  
 Figuras Calços do travão de disco / Rysunki okładzin hamulców tarczowych /  
 Zobrazení obložení kotoučových brzd

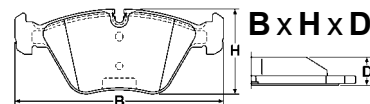

scale - échelle - scala - escala - skala - měřítko 1:2

## B1.G102-0798.2 G1020798      B1.G102-0800.2 G1020800

TOYOTA

ATE

FORD

BOS

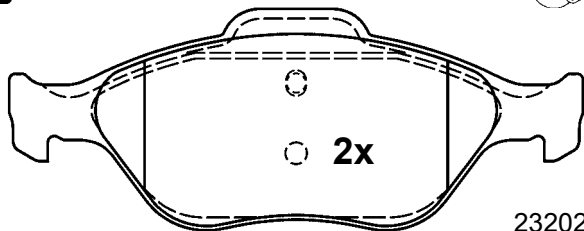

2x  
151,3 x 58,2 x 17,8

23202 17,8

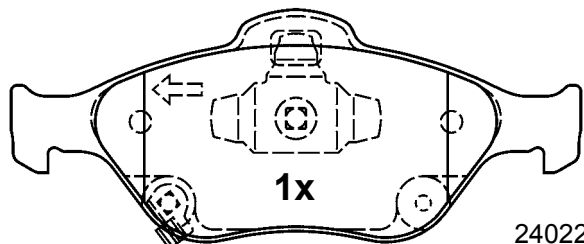

1x  
150,1 x 61,0 x 17,8

24022 17,8

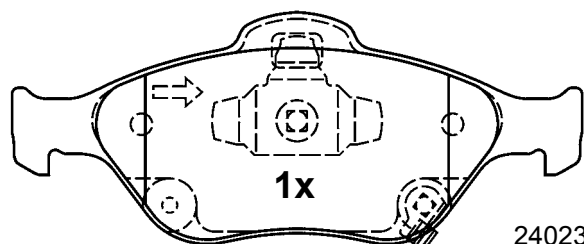

1x  
150,1 x 61,0 x 17,8

24023 17,8

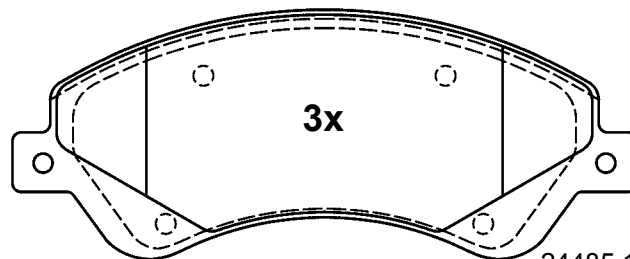

3x

24485 19,0

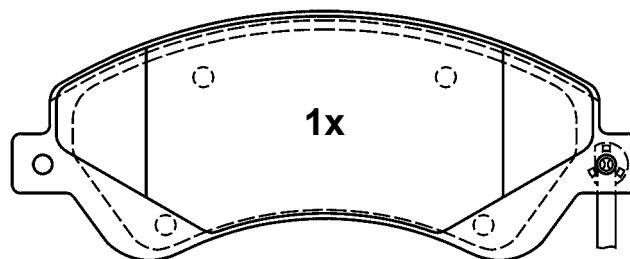

1x

24485 19,0

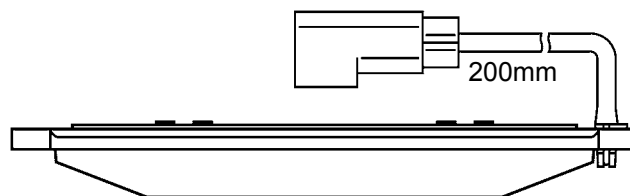

200mm

164,8 x 65,5 x 19,0

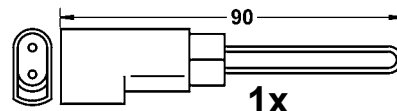

1x

## B1.G102-0799.2 G1020799

CITROEN

BOS

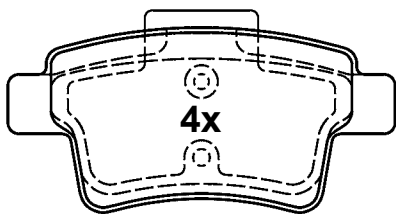

4x

24540 16,3

101,8 x 48,3 x 16,3

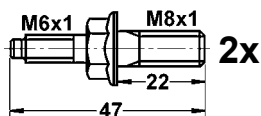

2x

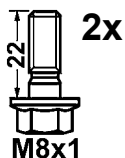

2x

M8x1

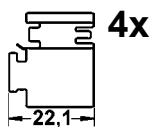

4x

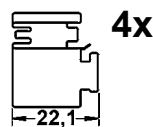

4x

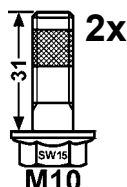

2x

M10

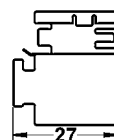

4x

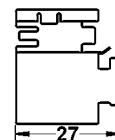

4x

# Illustrations disc brake pads

Illustrations plaquettes de frein à disque / Illustrazioni pastiglie freno /  
 Figuras Calços do travão de disco / Rysunki okładzin hamulców tarczowych /  
 Zobrazení obložení kotoučových brzd

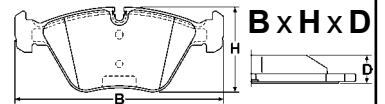

scale - échelle - scala - escala - skala - měřítko 1:2

## B1.G102-0801.2 G1020801



FORD



BOS

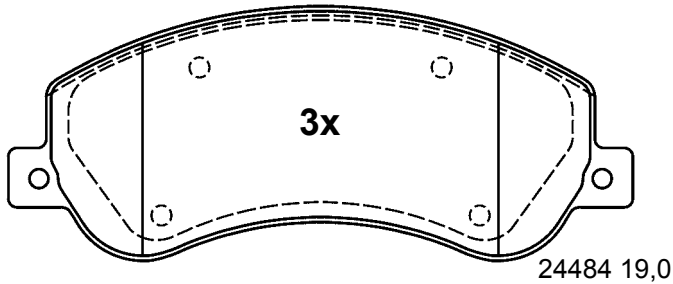

24484 19,0

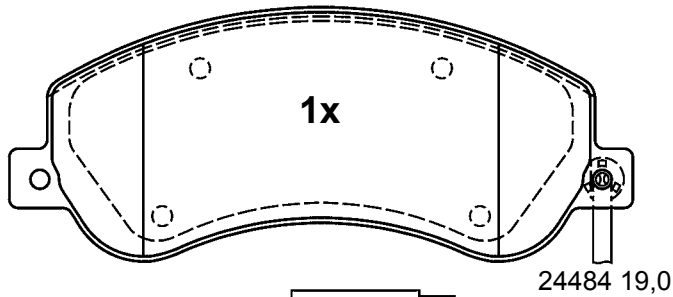

24484 19,0

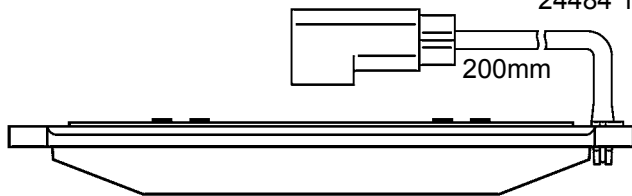

164,8 x 66,8 x 19,0

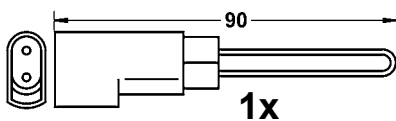

1x

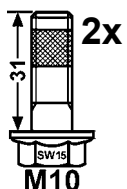

2x

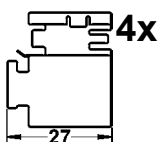

4x

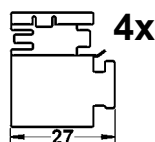

4x

## B1.G102-0802.2 G1020802



FORD



BOS

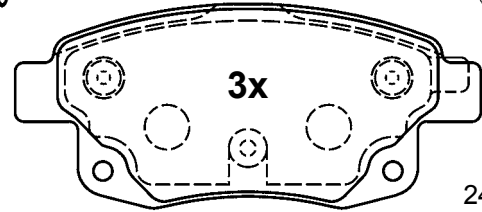

24486 17,4

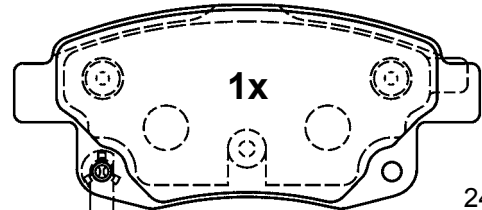

24486 17,4

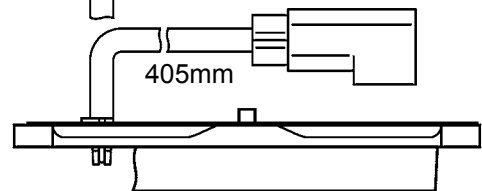

122,8 x 53,6 x 17,4

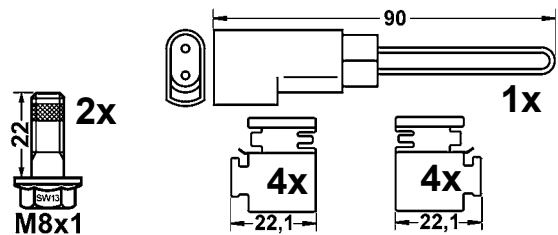

1x

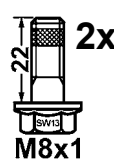

2x

M8x1



4x



4x

## B1.G102-0803.2 G1020803



BMW



ATE

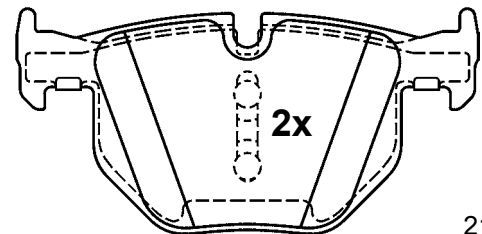

21282 17,3

121,8 x 59,2 x 17,3

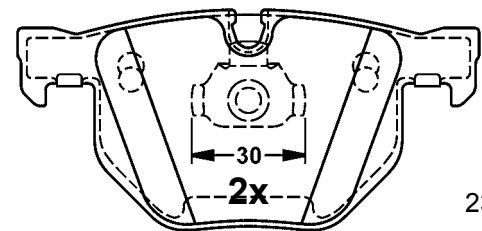

23447 17,3

121,8 x 57,8 x 17,3

# Illustrations disc brake pads

Illustrations plaquettes de frein à disque / Illustrazioni pastiglie freno /  
 Figuras Calços do travão de disco / Rysunki okładzin hamulców tarczowych /  
 Zobrazení obložení kotoučových brzd

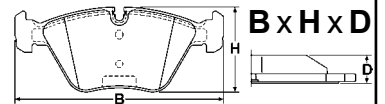

scale - échelle - scala - escala - skala - měřítko 1:2

<b>B1.G102-0806.2 G1020806</b>	<b>B1.G102-0812.2 G1020812</b>
--------------------------------	--------------------------------

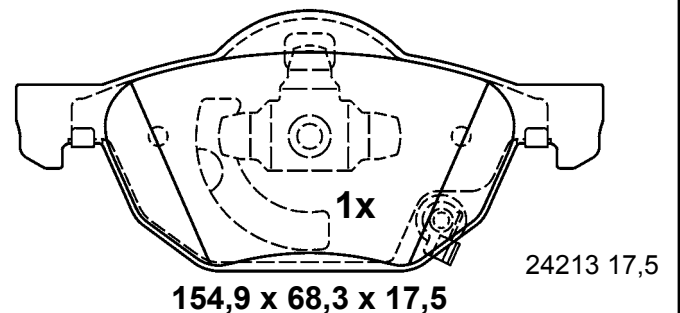
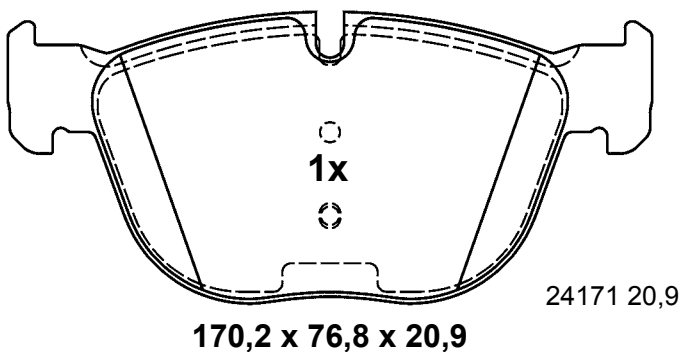
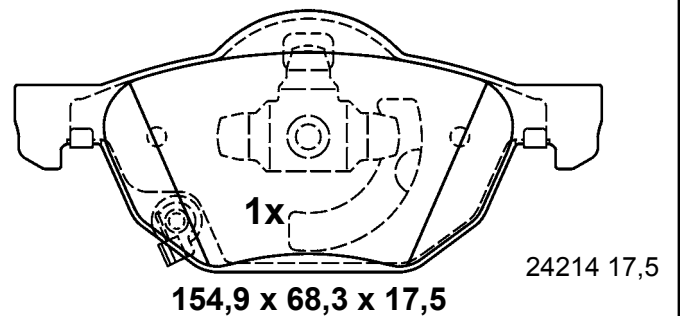
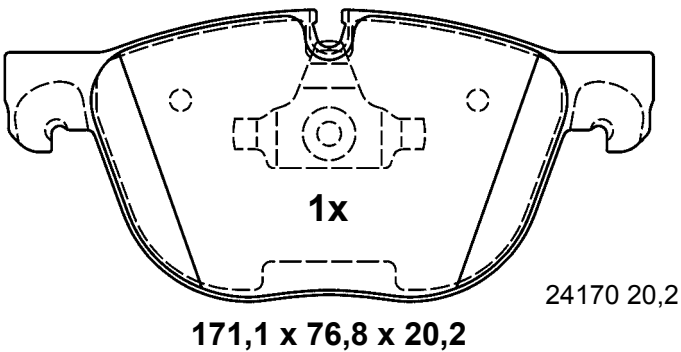
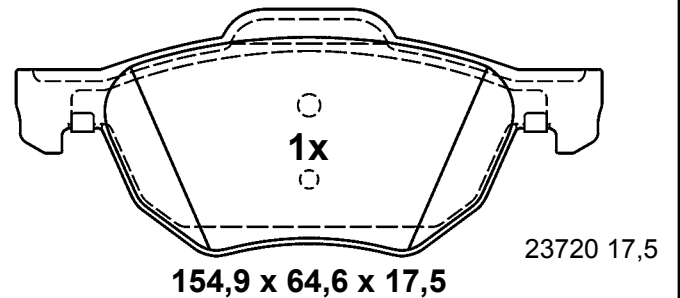
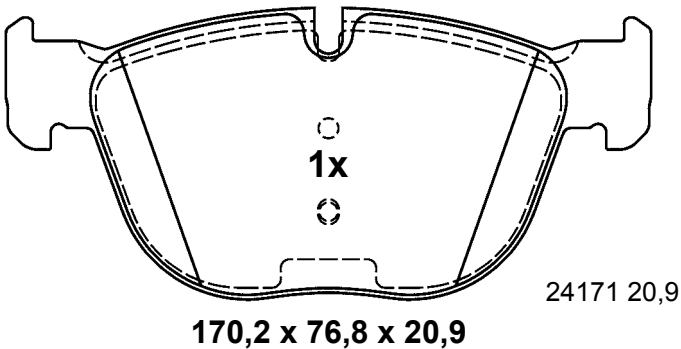
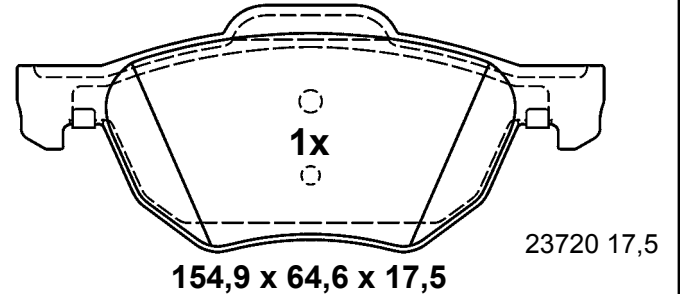
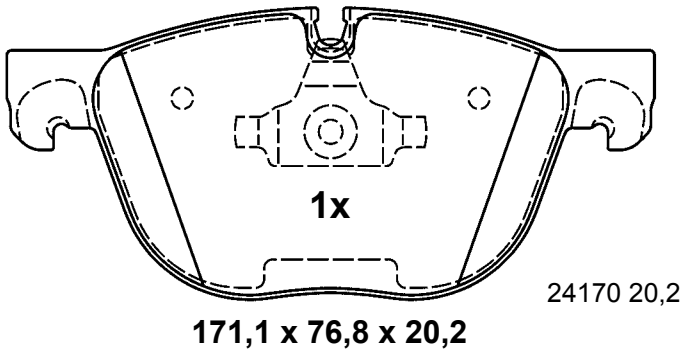

# Illustrations disc brake pads

Illustrations plaquettes de frein à disque / Illustrazioni pastiglie freno /  
 Figuras Calços do travão de disco / Rysunki okładzin hamulców tarczowych /  
 Zobrazení obložení kotoučových brzd

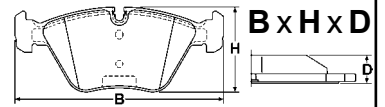

scale - échelle - scala - escala - skala - měřítko 1:2

B1.G102-0817.2 G1020817	B1.G102-0819.2 G1020819
-------------------------	-------------------------

HONDA



HONDA

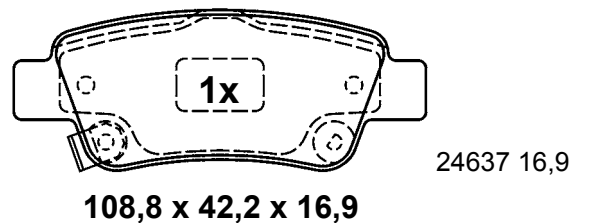
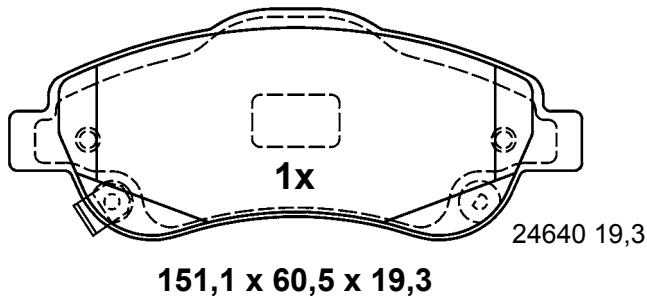
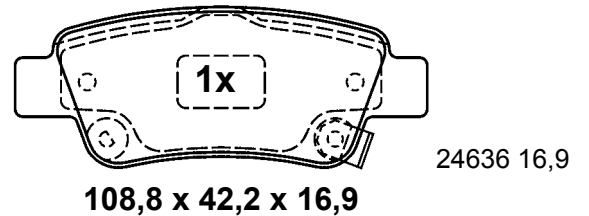
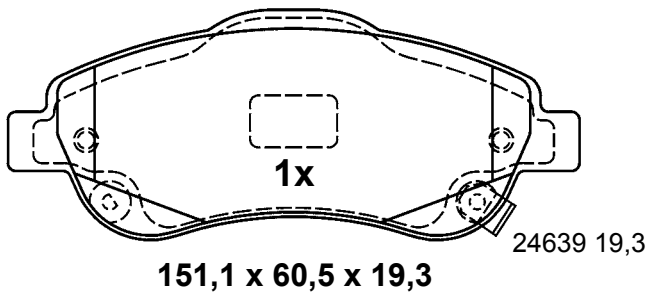
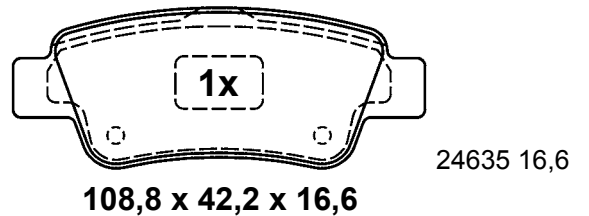
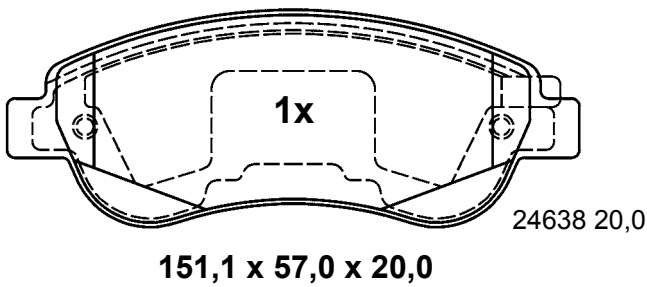
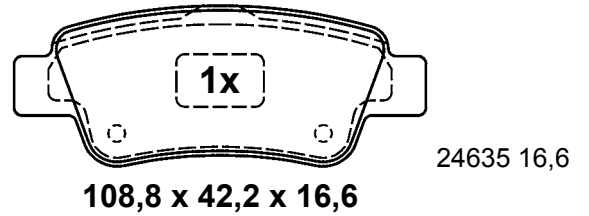
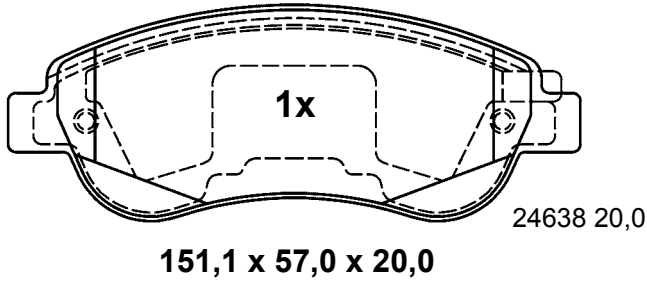

# Illustrations disc brake pads

Illustrations plaquettes de frein à disque / Illustrazioni pastiglie freno /  
 Figuras Calços do travão de disco / Rysunki okładzin hamulców tarczowych /  
 Zobrazení obložení kotoučových brzd

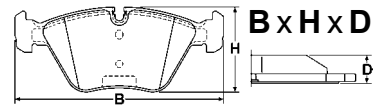

scale - échelle - scala - escala - skala - měřítko 1:2

## B1.G102-0823.2 G1020823



AUDI



ATE

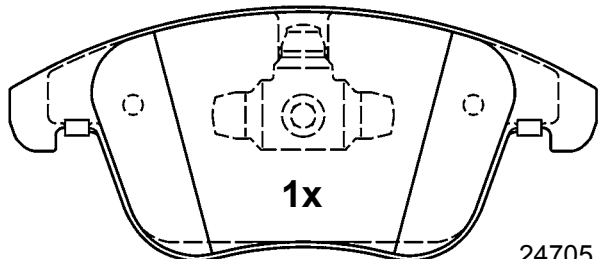

1x

155,1 x 67,0 x 19,8

24705 19,8

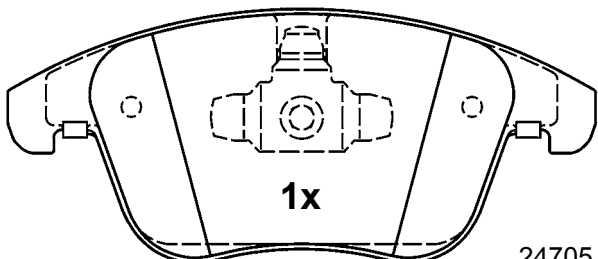

1x

155,1 x 67,0 x 19,8

24705 19,8

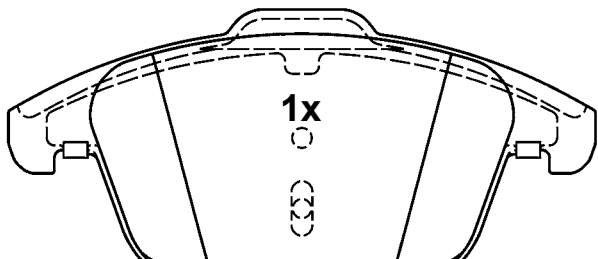

1x

155,1 x 72,0 x 21,3

24707 21,3

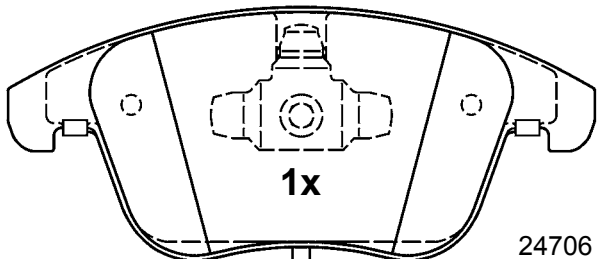

1x

155,1 x 67,0 x 21,3

24706 21,3

281mm

## B1.G102-0825.2 G1020825



IVECO



BRE

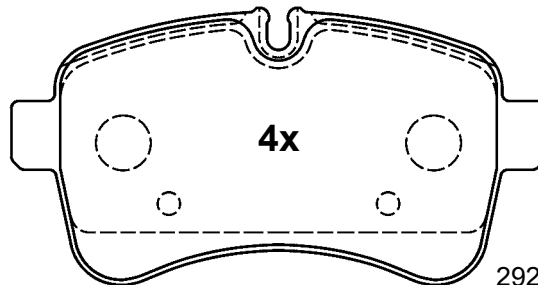

4x

141,1 x 72,6 x 21,0

29232 21,0

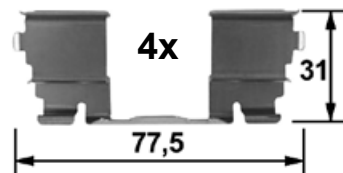

4x

31

77,5

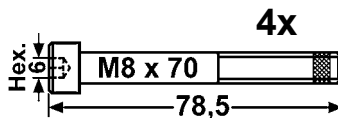

4x

M8 x 70

78,5

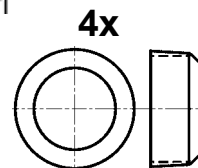

4x

## B1.G102-0828.2 G1020828



IVECO



BRE

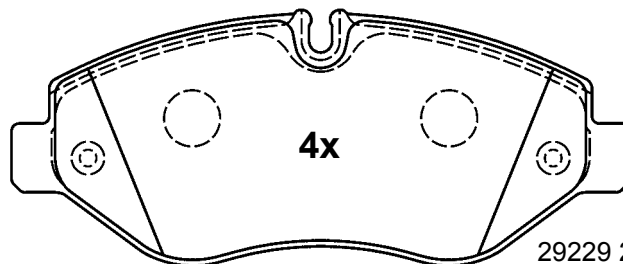

4x

163,1 x 67,1 x 20,7

29229 20,7

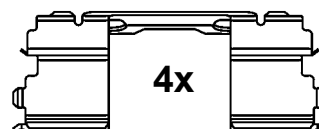

4x

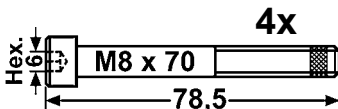

4x

M8 x 70

78,5

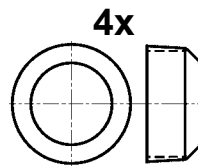

4x

# Illustrations disc brake pads

Illustrations plaquettes de frein à disque / Illustrazioni pastiglie freno /  
 Figuras Calços do travão de disco / Rysunki okładzin hamulców tarczowych /  
 Zobrazení obložení kotoučových brzd

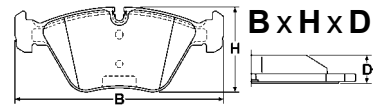

scale - échelle - scala - escala - skala - měřítko 1:2

<b>B1.G102-0829.2 G1020829</b>	<b>B1.G102-0833.2 G1020833</b>
--------------------------------	--------------------------------

**MERCEDES BENZ**

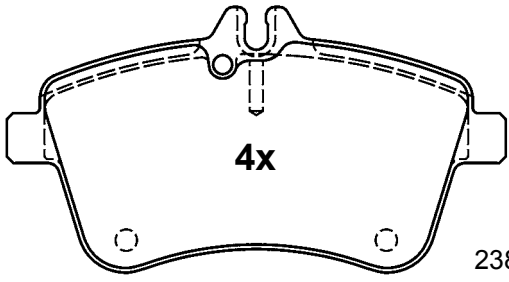

23881 20,0

**131,3 x 69,8 x 20,0**

  
**2x**  
 M8x21

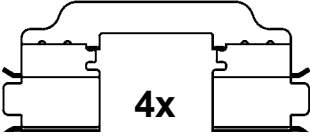
  
**4x**

**OPEL, VAUXHALL**

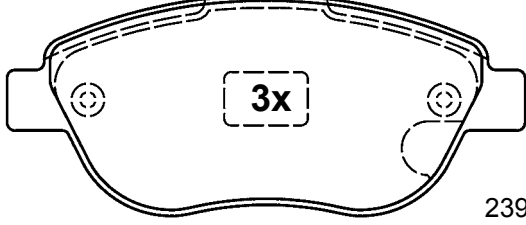

23981 19,0

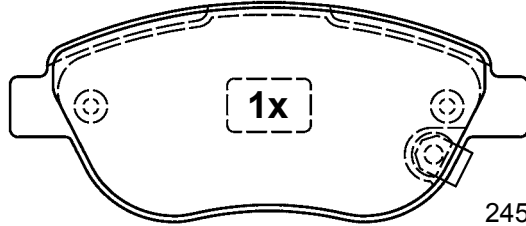

24549 19,0

**136,8 x 57,4 x 19,0**

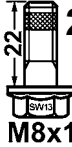
  
**2x**  
 M8x1

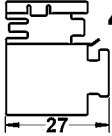
  
**4x**  
 27

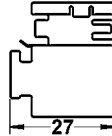
  
**4x**  
 27

**B1.G102-0830.2 G1020830**

**CITROEN, PEUGEOT, TOYOTA**

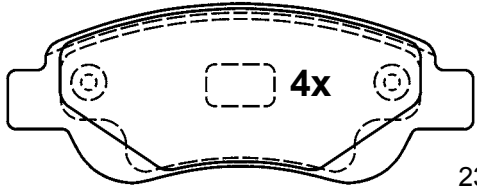

23959 17,0

**122,6 x 46,9 x 17,0**

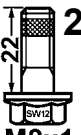
  
**2x**  
 M8x1

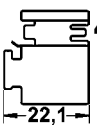
  
**4x**  
 22,1

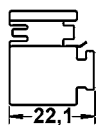
  
**4x**  
 22,1

**B1.G102-0834.2 G1020834**

**RENAULT**

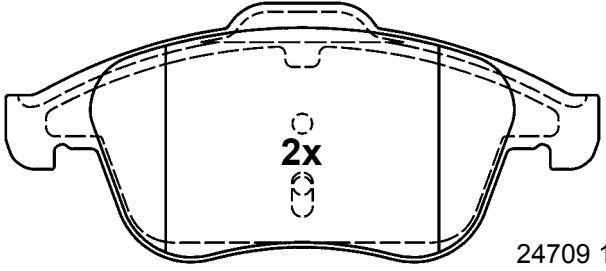

24709 18,6

**156,3 x 68,3 x 18,6**

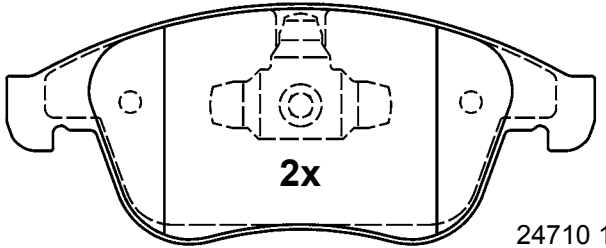

24710 18,6

**155,1 x 63,0 x 18,6**



# Illustrations disc brake pads

Illustrations plaquettes de frein à disque / Illustrazioni pastiglie freno /  
Figuras Calços do travão de disco / Rysunki okładzin hamulców tarczowych /  
Zobrazení obložení kotoučových brzd

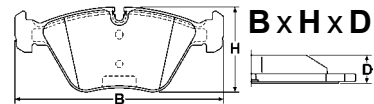

scale - échelle - scala - escala - skala - měřítko 1:2

## B1.G102-0836.2 G1020836



FIAT



ATE

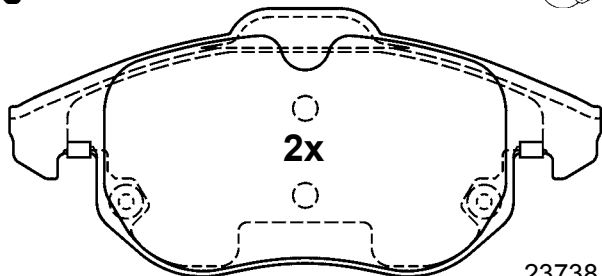

156,3 x 70,7 x 20,1

23738 20,1

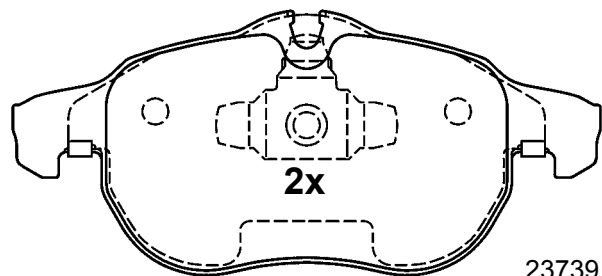

155,1 x 69,6 x 20,1

23739 20,1

## B1.G102-0846.2 G1020846



BMW



ATE

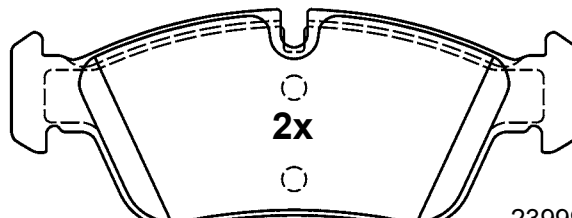

149,3 x 57,3 x 17,8

23999 17,8

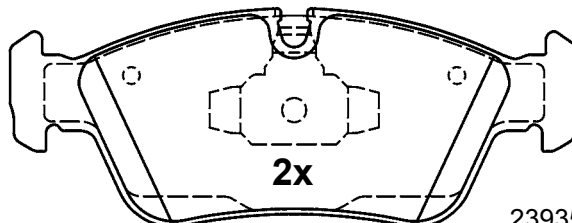

150,1 x 57,3 x 17,8

23935 17,8

## B1.G102-0844.2 G1020844



BMW



LUC

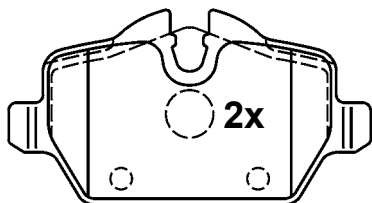

95,2 x 51,0 x 17,4

23623 17,4

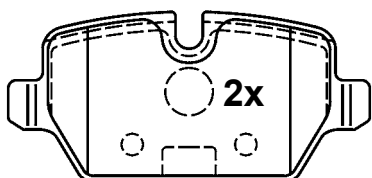

95,2 x 44,6 x 17,4

23624 17,4



M8x21

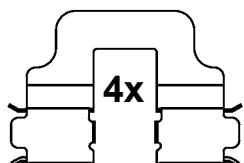

4x

## B1.G102-0848.2 G1020848



BMW



ATE

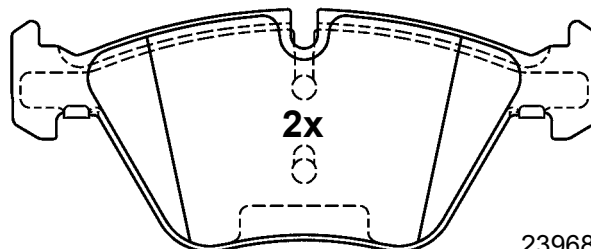

154,6 x 63,5 x 20,3

23968 20,3

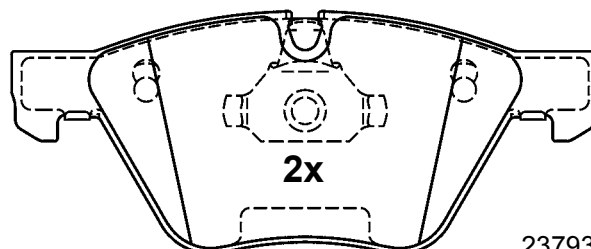

155,1 x 63,5 x 20,3







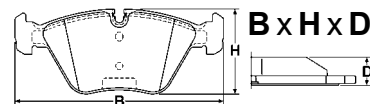





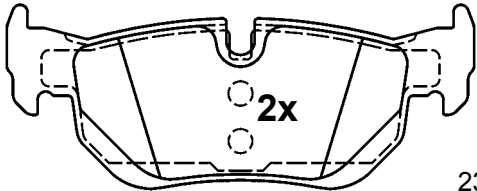
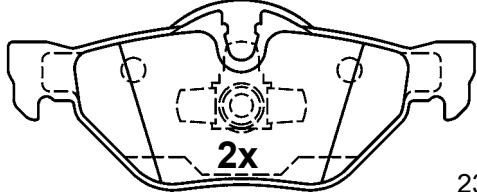

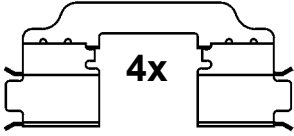

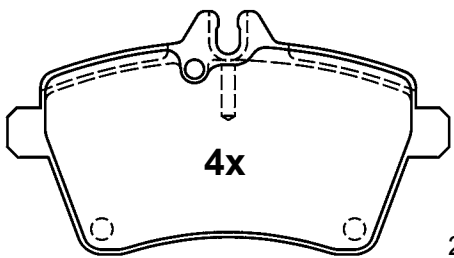
23793 20,3

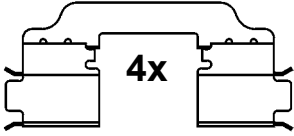
# Illustrations disc brake pads

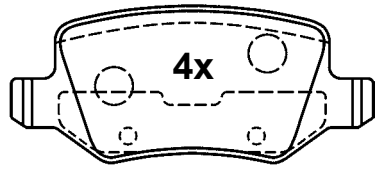
Illustrations plaquettes de frein à disque / Illustrazioni pastiglie freno /  
 Figuras Calços do travão de disco / Rysunki okładzin hamulców tarczowych /  
 Zobrazení obložení kotoučových brzd

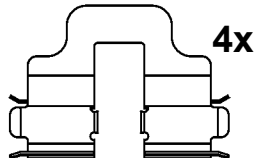

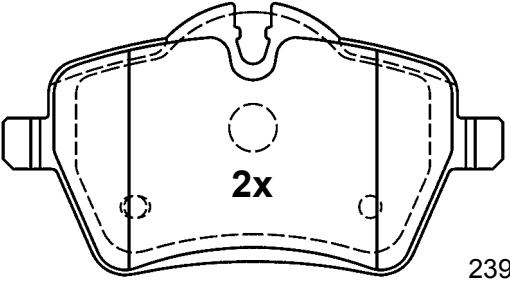
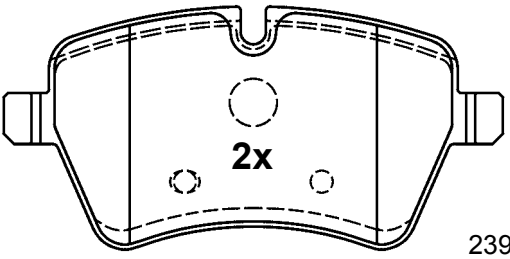
scale - échelle - scala - escala - skala - měřítko 1:2

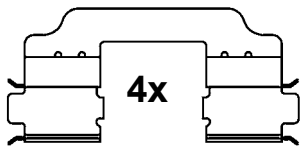
B1.G102-0850.2 G1020850	B1.G102-0855.2 G1020855
<p> <b>BMW</b>  <b>ATE</b></p>  <p><b>2x</b></p> <p>23927 17,3</p> <p><b>123,0 x 48,1 x 17,3</b></p>  <p><b>2x</b></p> <p>23926 17,3</p> <p><b>123,0 x 49,7 x 17,3</b></p>  <p><b>2x</b></p> <p><b>M8x21</b></p>  <p><b>4x</b></p>	<p> <b>MERCEDES BENZ</b>  <b>LUC</b></p>  <p><b>4x</b></p> <p>24077 19,1</p> <p><b>116,4 x 63,8 x 19,1</b></p>  <p><b>2x</b></p> <p><b>M8x21</b></p>  <p><b>4x</b></p>
B1.G102-0852.2 G1020852	B1.G102-0856.2 G1020856
<p> <b>MERCEDES BENZ</b>  <b>LUC</b></p>  <p><b>4x</b></p> <p>23138 14,6</p> <p><b>95,7 x 41,3 x 14,6</b></p>  <p><b>2x</b></p> <p><b>M8x21</b></p>  <p><b>4x</b></p>	<p> <b>MINI</b>  <b>LUC</b></p>  <p><b>2x</b></p> <p>23984 17,8</p> <p><b>131,6 x 71,3 x 17,8</b></p>  <p><b>2x</b></p> <p>23985 17,8</p> <p><b>131,6 x 63,9 x 17,8</b></p>  <p><b>2x</b></p> <p><b>M8x21</b></p>  <p><b>4x</b></p>



# Illustrations disc brake pads

Illustrations plaquettes de frein à disque / Illustrazioni pastiglie freno /  
Figuras Calços do travão de disco / Rysunki okładzin hamulców tarczowych /  
Zobrazení obložení kotoučových brzd

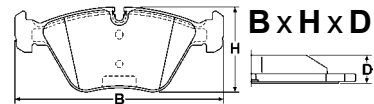

scale - échelle - scala - escala - skala - měřítko 1:2

## B1.G102-0858.2 G1020858



OPEL, VAUXHALL



BOS

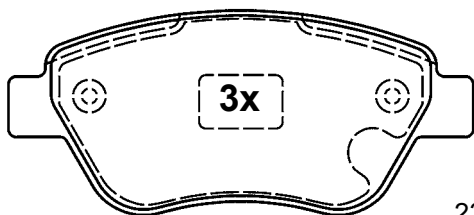

23707 18,0

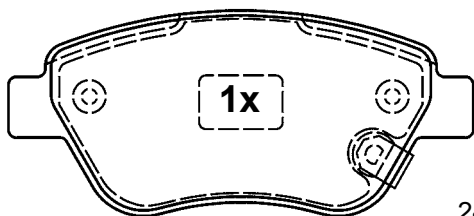

24288 18,0

122,8 x 53,3 x 18,0

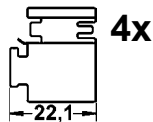
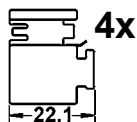
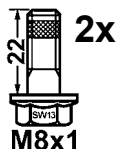

## B1.G102-0859.2 G1020859



PEUGEOT



BOS

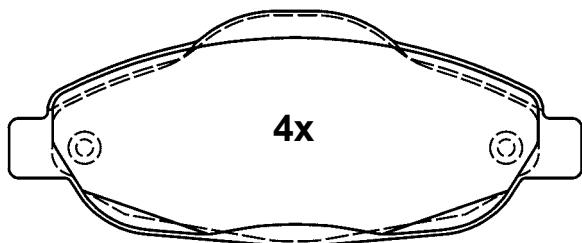

24660 17,8

151,0 x 62,0 x 17,8

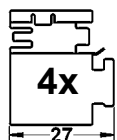
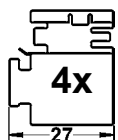
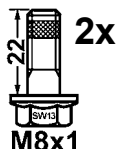

## B1.G102-0860.2 G1020860



MERCEDES BENZ



ATE

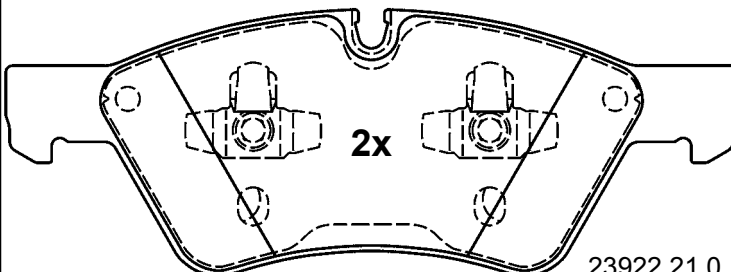

23922 21,0

192,9 x 69,9 x 21,0

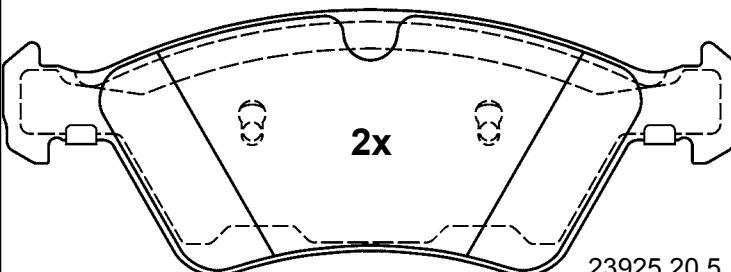

23925 20,5

194,3 x 70,0 x 20,5

## B1.G102-0862.2 G1020862



MERCEDES BENZ



ATE

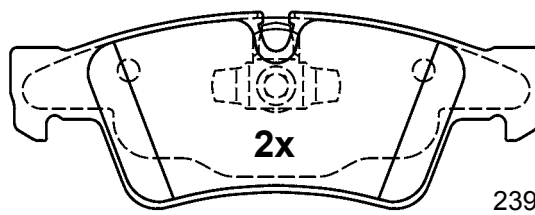

23923 17,6

140,1 x 51,6 x 17,6

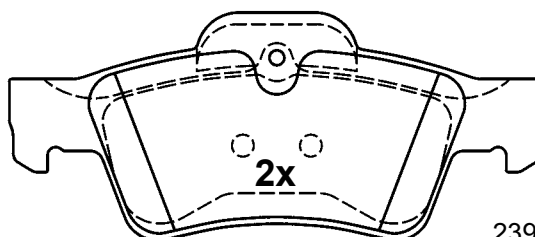

23924 17,6

141,3 x 59,6 x 17,6

# Illustrations disc brake pads

Illustrations plaquettes de frein à disque / Illustrazioni pastiglie freno /  
 Figuras Calços do travão de disco / Rysunki okładzin hamulców tarczowych /  
 Zobrazení obložení kotoučových brzd

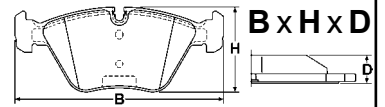

scale - échelle - scala - escala - skala - měřítko 1:2

<b>B1.G102-0866.2 G1020866</b>	<b>B1.G102-0871.2 G1020871</b>
--------------------------------	--------------------------------

**NISSAN**

**4x**

24632 17,0

**142,0 x 59,0 x 17,0**

**RENAULT**

**1x**

23215 18,3

**156,3 x 66,8 x 18,3**

**1x**

24535 18,3

**155,1 x 68,9 x 18,3**

**B1.G102-0867.2 G1020867**

**RENAULT**

**2x**

23245 18,3

**156,3 x 68,3 x 18,3**

**2x**

24536 18,3

**155,1 x 70,8 x 18,3**

**RENAULT**

**1x**

23215 18,3

**156,3 x 66,8 x 18,3**

**1x**

24535 18,3

**155,1 x 68,9 x 18,3**



# Illustrations disc brake pads

Illustrations plaquettes de frein à disque / Illustrazioni pastiglie freno /  
 Figuras Calços do travão de disco / Rysunki okładzin hamulców tarczowych /  
 Zobrazení obložení kotoučových brzd

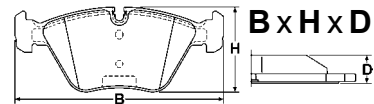

scale - échelle - scala - escala - skala - měřítko 1:2

## B1.G102-0872.2 G1020872



CITROEN, FIAT, PEUGEOT



BRE

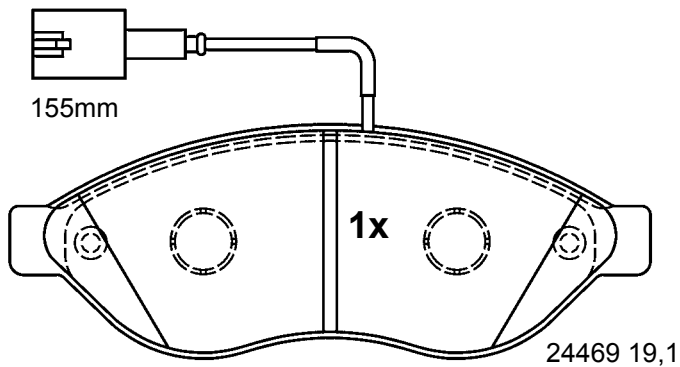
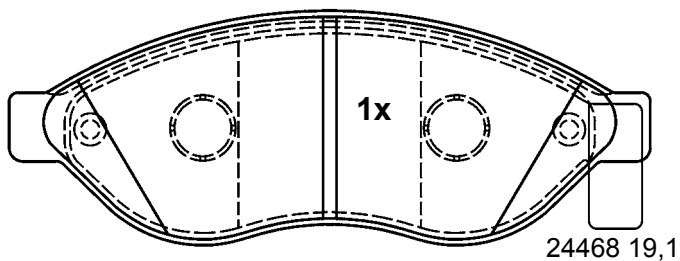
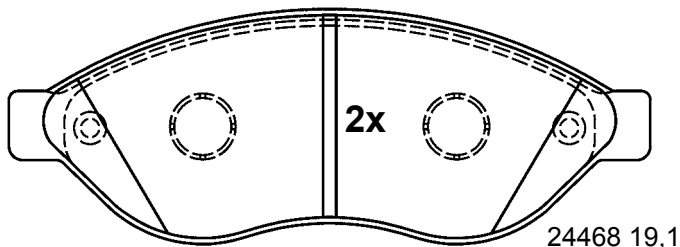

169,2 x 61,5 x 19,1

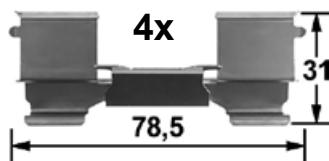

4x

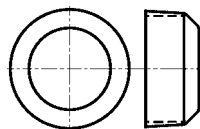
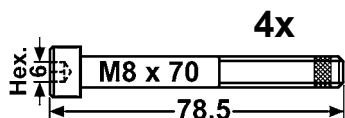

## B1.G102-0873.2 G1020873



CITROEN, FIAT, PEUGEOT



BRE

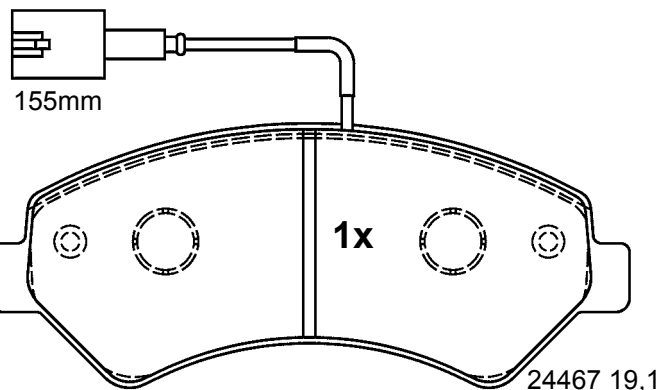
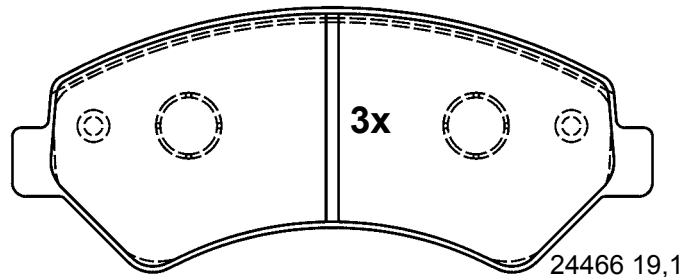

169,2 x 69,1 x 19,1

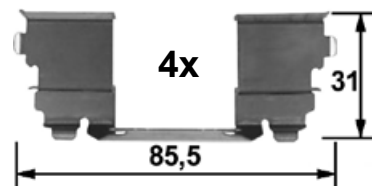

4x

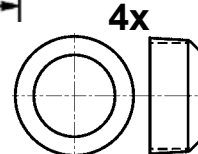
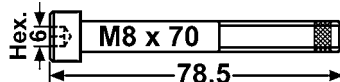

## B1.G102-0874.2 G1020874



MERCEDES BENZ, RENAULT



LUC

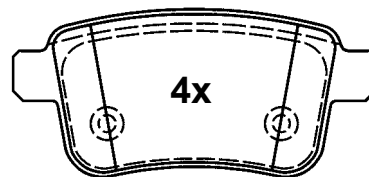

95,4 x 43,8 x 15,9

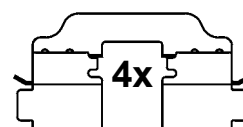





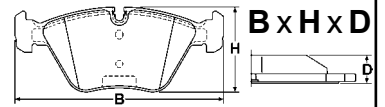





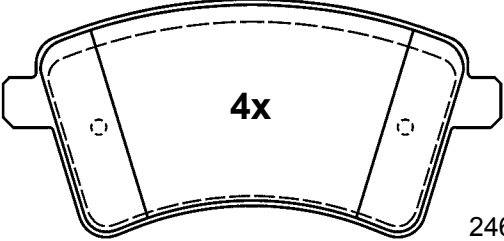

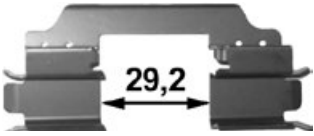
# Illustrations disc brake pads

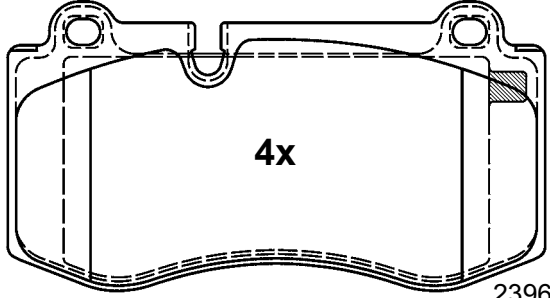
Illustrations plaquettes de frein à disque / Illustrazioni pastiglie freno /  
 Figuras Calços do travão de disco / Rysunki okładzin hamulców tarczowych /  
 Zobrazení obložení kotoučových brzd

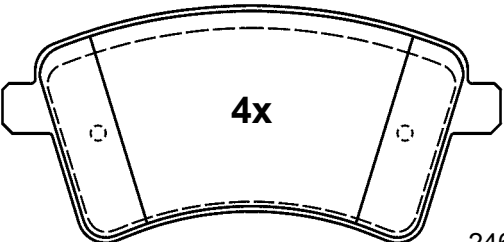

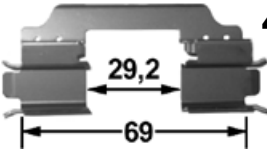
scale - échelle - scala - escala - skala - měřítko 1:2

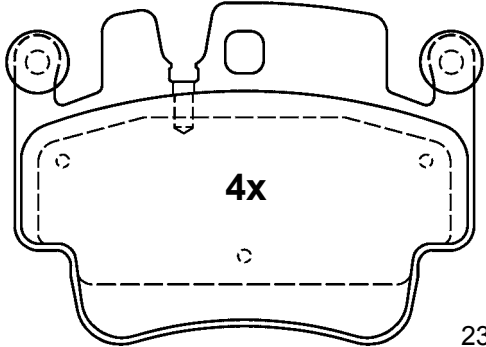
B1.G102-0875.2 G1020875	B1.G102-0877.2 G1020877
<p>  RENAULT                      LUC                 </p>  <p>4x</p> <p>24693 18,5</p> <p>131,0 x 62,3 x 18,5</p>  2x M8x22  4x 29,2	<p>  MERCEDES BENZ                      BRE                 </p>  <p>4x</p> <p>23960 18,3</p> <p>141,6 x 75,8 x 18,3</p>
B1.G102-0876.2 G1020876	B1.G102-0882.2 G1020882
<p>  MERCEDES BENZ, RENAULT                      LUC                 </p>  <p>4x</p> <p>24693 17,5</p> <p>131,0 x 62,3 x 17,5</p>  2x M8x22  4x 29,2 69	<p>  PORSCHE                      BRE                 </p>  <p>4x</p> <p>23329 17,0</p> <p>121,3 x 90,3 x 17,0</p>

# Illustrations disc brake pads

Illustrations plaquettes de frein à disque / Illustrazioni pastiglie freno /  
 Figuras Calços do travão de disco / Rysunki okładzin hamulców tarczowych /  
 Zobrazení obložení kotoučových brzd

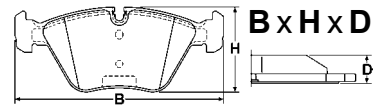

scale - échelle - scala - escala - skala - měřítko 1:2

<b>B1.G102-0883.2 G1020883</b>	<b>B1.G102-0889.2 G1020889</b>
--------------------------------	--------------------------------

**PORSCHE** **BRE**

**4x**

21792 15,2

**112,2 x 73,0 x 15,2**

**FORD, LAND ROVER, VOLVO** **ATE**

**2x**

24123 20,3

**155,1 x 66,6 x 20,3**

<b>B1.G102-0885.2 G1020885</b>	
--------------------------------	--

**FORD** **BDX**

**4x**

21586 15,0

**115,7 x 53,6 x 15,0**

**2x**

24124 19,3

**156,3 x 72,0 x 19,3**

<b>B1.G102-0886.2 G1020886</b>	
--------------------------------	--

**FORD** **BDX**

**2x**

23410 15,0  
(21586)

**2x**

23411 15,0

195mm

**115,7 x 53,6 x 15,0**

<b>B1.G102-0891.2 G1020891</b>	
--------------------------------	--

**MERCEDES BENZ, VOLKSWAGEN** **PER**

**4x**

29153 20,0

**164,6 x 73,0 x 20,0**

**4x**

**M8x21**

# Illustrations disc brake pads

Illustrations plaquettes de frein à disque / Illustrazioni pastiglie freno /  
Figuras Calços do travão de disco / Rysunki okładzin hamulców tarczowych /  
Zobrazení obložení kotoučových brzd

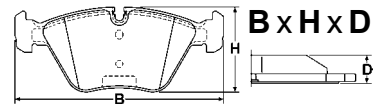

scale - échelle - scala - escala - skala - měřítko 1:2

## B1.G102-0893.2 G1020893



CITROËN



ATE

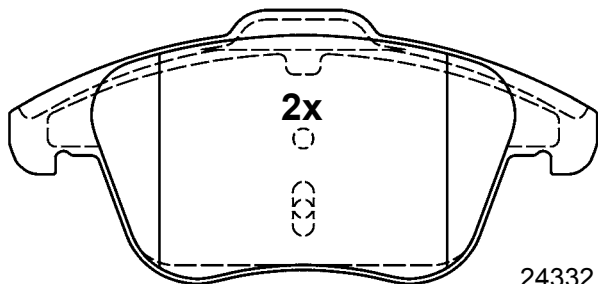

24332 18,3

155,1 x 72,0 x 18,3

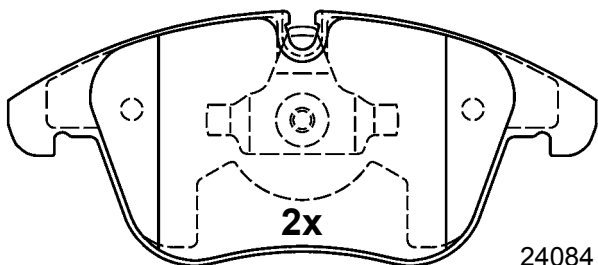

24084 19,3

155,2 x 66,5 x 19,3

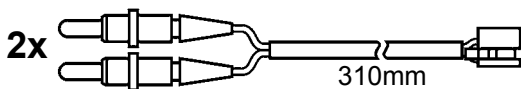

310mm

## B1.G102-0895.2 G1020895



AUDI, SEAT, VOLKSWAGEN



ATE

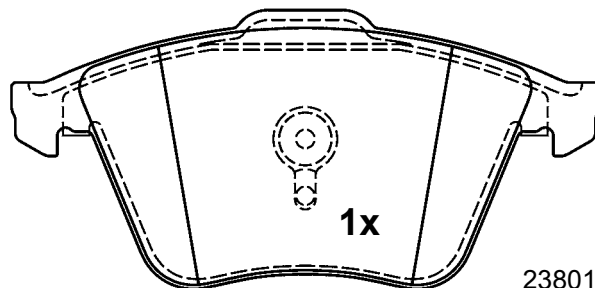

23801 20,3

156,3 x 72,9 x 20,3

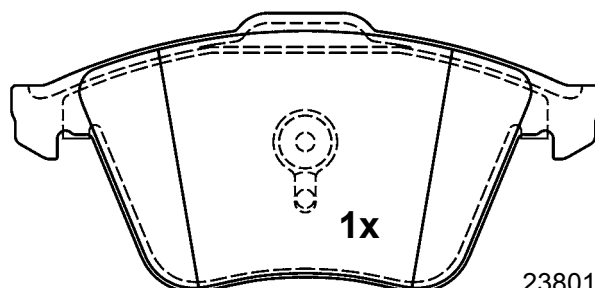

23801 20,3

156,3 x 72,9 x 20,3

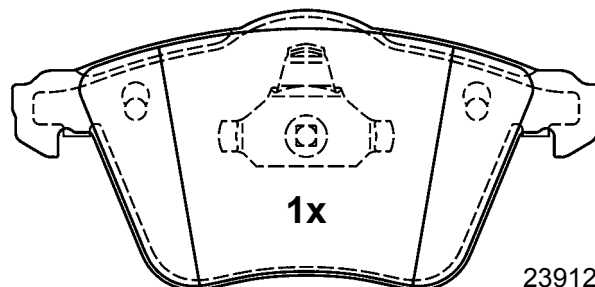

23912 20,3

155,1 x 72,9 x 20,3

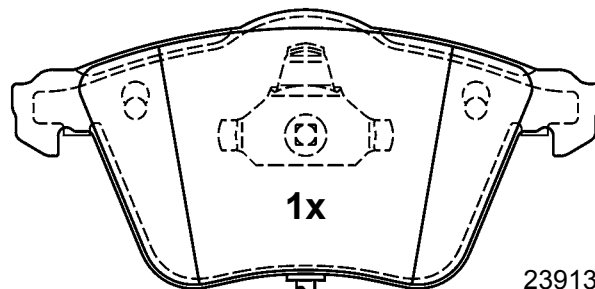

23913 20,3

155,1 x 72,9 x 20,3

177,5mm

## B1.G102-0907.2 G1020907



OPEL, RENAULT, VAUXHALL



BRE

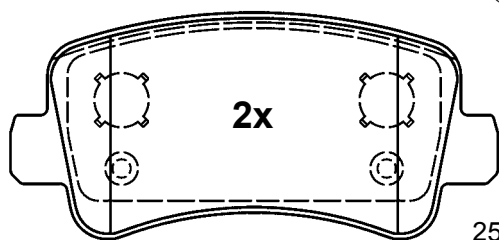

25112 18,4

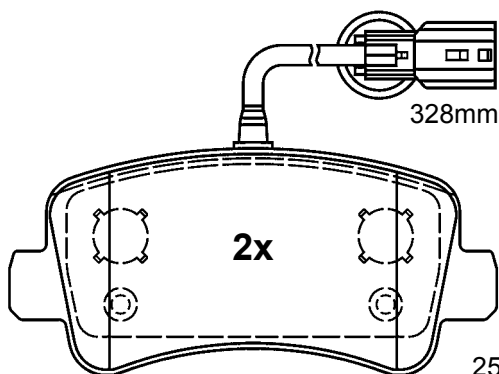

328mm

25113 18,4

128,5 x 59,5 x 18,4

# Illustrations disc brake pads

Illustrations plaquettes de frein à disque / Illustrazioni pastiglie freno /  
Figuras Calços do travão de disco / Rysunki okładzin hamulców tarczowych /  
Zobrazení obložení kotoučových brzd

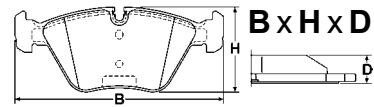

scale - échelle - scala - escala - skala - měřítko 1:2

<b>B1.G102-0896.2 G1020896</b>	<b>B1.G102-0901.2 G1020901</b>
--------------------------------	--------------------------------

LAND ROVER

**2x**

**156,3 x 73,2 x 18,7**

23397 18,7

**2x**

**155,0 x 73,2 x 18,7**

23399 18,7

LAND ROVER

**4x**

23615 18,3

**4x**

**M8x22**

**131,4 x 62,1 x 18,3**

**B1.G102-0900.2 G1020900**

VOLVO

**4x**

24496 17,3

**106,1 x 48,7 x 17,3**

**2x**

25147 18,4

**2x**

**2x**

**4x**

**M8x21**

**B1.G102-0905.2 G1020905**

OPEL, RENAULT, VAUXHALL

**2x**

25147 18,4

**2x**

110mm

25148 18,4

**163,5 x 64,6 x 18,4**

# Illustrations disc brake pads

Illustrations plaquettes de frein à disque / Illustrazioni pastiglie freno /  
 Figuras Calços do travão de disco / Rysunki okładzin hamulców tarczowych /  
 Zobrazení obložení kotoučových brzd

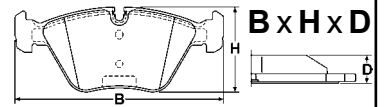

scale - échelle - scala - escala - skala - měřítko 1:2

<b>B1.G102-0920.2 G1020920</b>	<b>B1.G102-0922.2 G1020922</b>
--------------------------------	--------------------------------

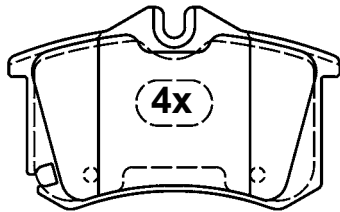

23554 16,8

87,2 x 52,9 x 16,8

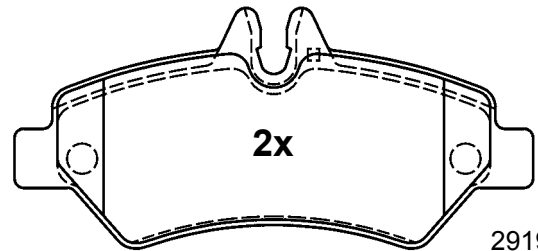

29190 20,2

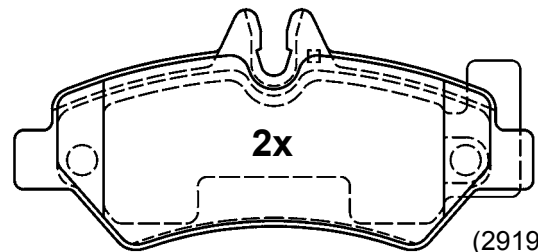
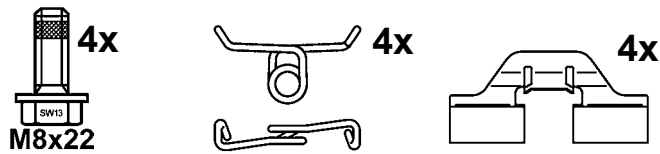

(29190) 20,2

<b>B1.G102-0921.2 G1020921</b>	
--------------------------------	--

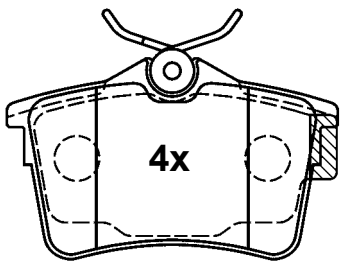

24765 16,5

87,2 x 52,8 x 16,5

136,8 x 63,0 x 20,2

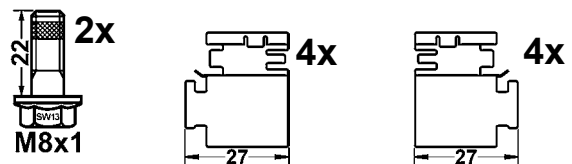
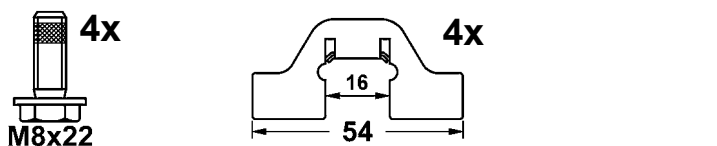
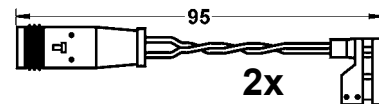



# Illustrations disc brake pads

Illustrations plaquettes de frein à disque / Illustrazioni pastiglie freno /  
 Figuras Calços do travão de disco / Rysunki okładzin hamulców tarczowych /  
 Zobrazení obložení kotoučových brzd

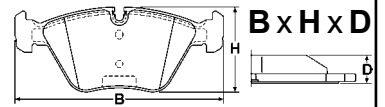

scale - échelle - scala - escala - skala - měřítko 1:2

## B1.G102-0924.2 G1020924



MERCEDES BENZ



LUC

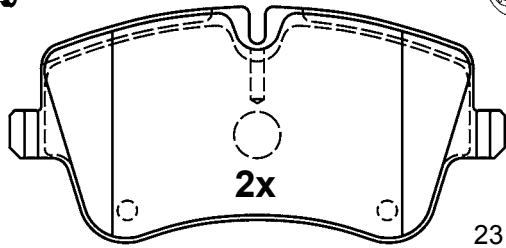

2x

23145 19,8

131,1 x 69,8 x 19,8

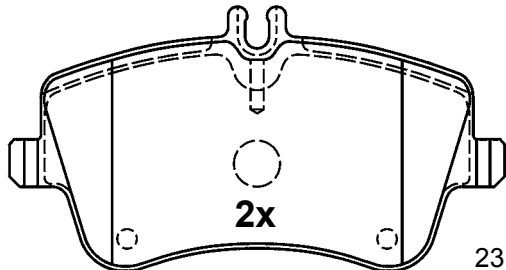

2x

23144 19,8

131,1 x 62,1 x 19,8



4x

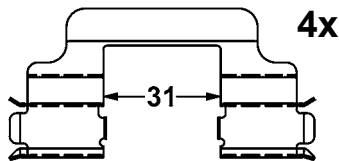

4x

31

## B1.G102-0928.2 G1020928



CHEVROLET, OPEL, VAUXHALL



ATE

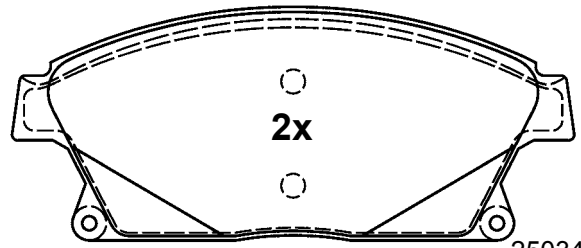

2x

25034 19,1

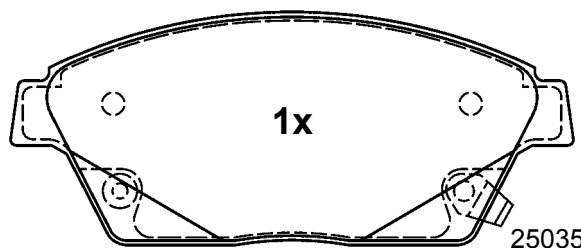

1x

25035 19,1

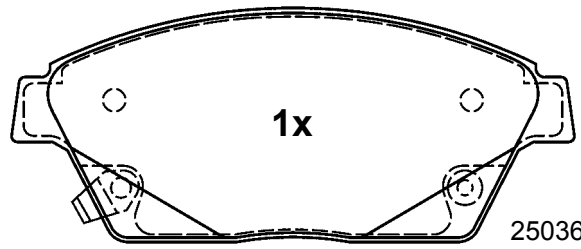

1x

25036 19,1

148,2 x 61,1 x 19,1

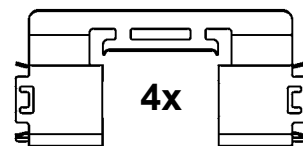

4x

## B1.G102-0925.2 G1020925



MERCEDES BENZ



LUC

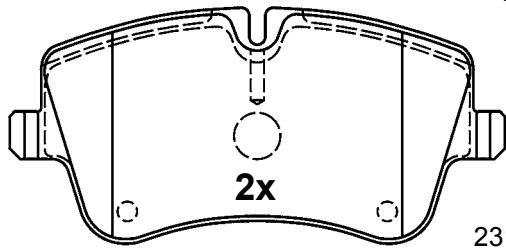

2x

23145 19,8

131,1 x 69,8 x 19,8

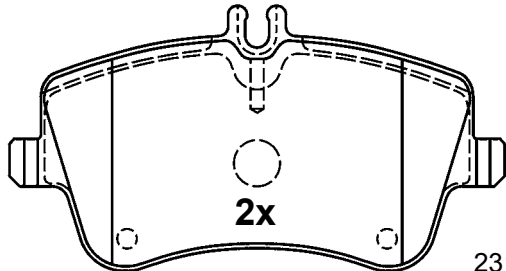

2x

23144 19,8

131,1 x 62,1 x 19,8



4x

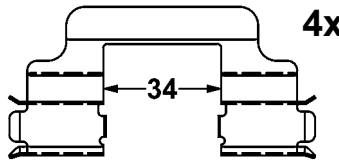

4x

34

## B1.G102-0933.2 G1020933



MERCEDES BENZ



LUC

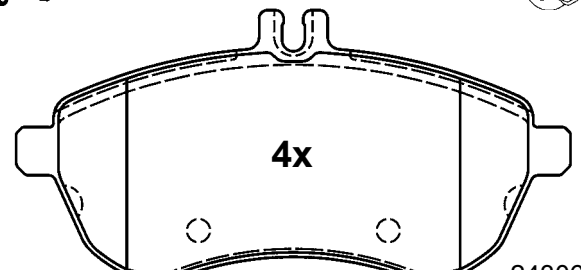

4x

24306 20,3

146,0 x 71,5 x 20,3



2x

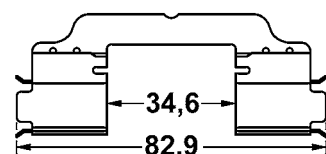

4x

34,6

82,9

# Illustrations disc brake pads

Illustrations plaquettes de frein à disque / Illustrazioni pastiglie freno /  
 Figuras Calços do travão de disco / Rysunki okładzin hamulców tarczowych /  
 Zobrazení obložení kotoučových brzd

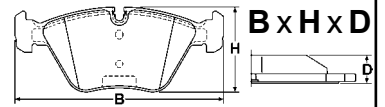

scale - échelle - scala - escala - skala - měřítko 1:2

<b>B1.G102-0934.2 G1020934</b>	<b>B1.G102-0935.2 G1020935</b>
--------------------------------	--------------------------------



MERCEDES BENZ



LUC



LUC

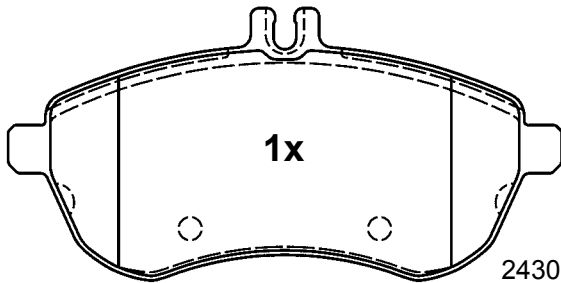

1x

24306 20,3

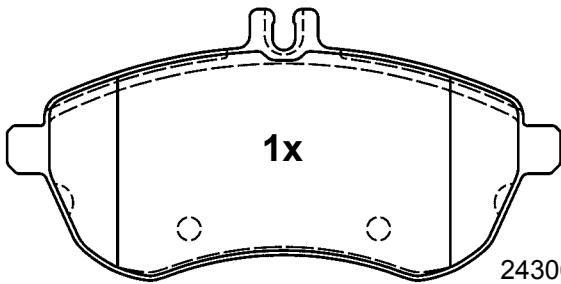

1x

24306 20,3

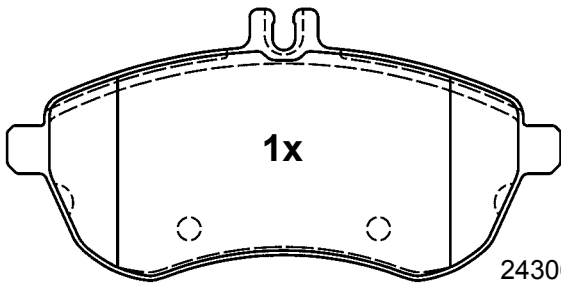

1x

24306 20,3

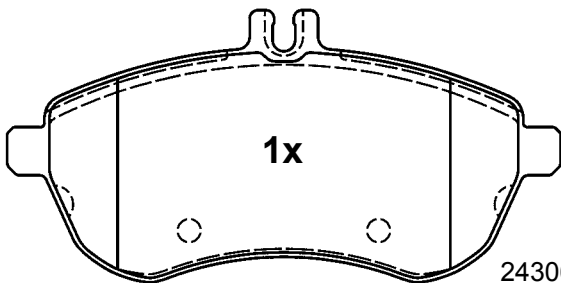

1x

24306 20,3

146,0 x 71,5 x 20,3



2x

M8x22

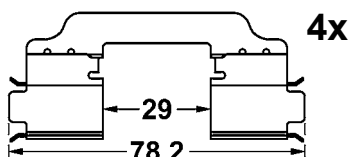

4x

29

78,2



MERCEDES BENZ



LUC

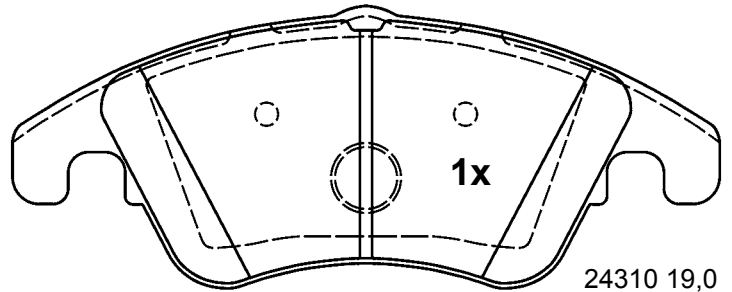

1x

24310 19,0

188,0 x 73,7 x 19,0

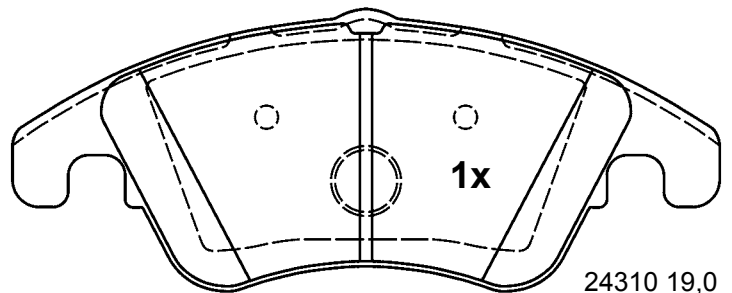

1x

24310 19,0

188,0 x 73,7 x 19,0

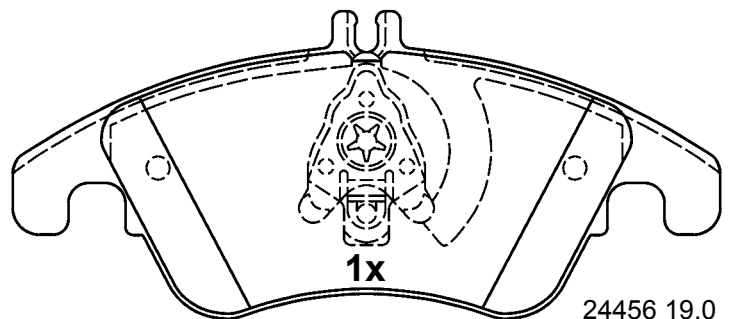

1x

24456 19,0

188,0 x 80,8 x 19,0

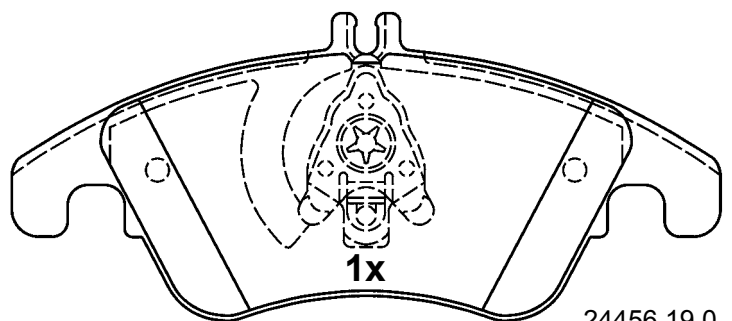

1x

24456 19,0

188,0 x 80,8 x 19,0

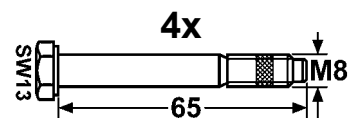

4x

SW13

65

M8



# Illustrations disc brake pads

Illustrations plaquettes de frein à disque / Illustrazioni pastiglie freno /  
Figuras Calços do travão de disco / Rysunki okładzin hamulców tarczowych /  
Zobrazení obložení kotoučových brzd

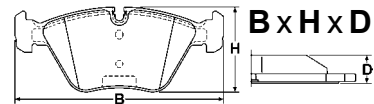

scale - échelle - scala - escala - skala - měřítko 1:2

## B1.G102-0937.2 G1020937



CITROEN, FIAT, PEUGEOT



LUC

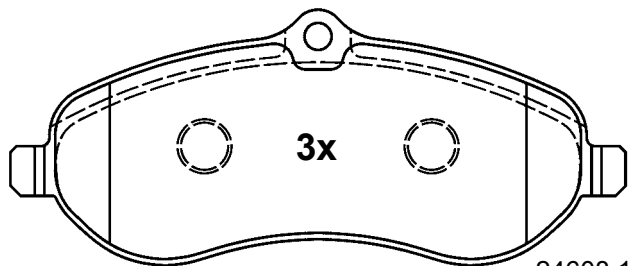

24608 18,5

3x

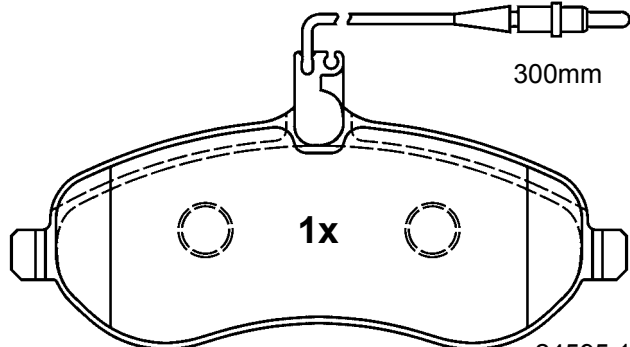

300mm

1x

24595 18,5

162,0 x 67,3 x 18,5



2x

M8x21

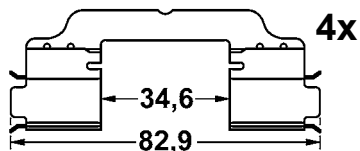

4x

34,6

82,9

## B1.G102-0939.2 G1020939



BMW



ATE

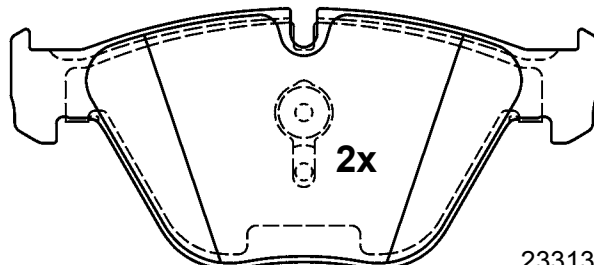

23313 20,3

2x

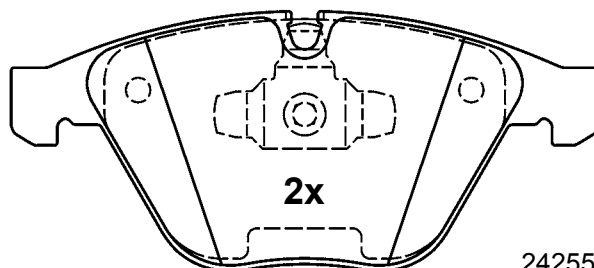

24255 20,3

2x

155,1 x 68,3 x 20,3

## B1.G102-0938.2 G1020938



CITROEN, FIAT, PEUGEOT



LUC

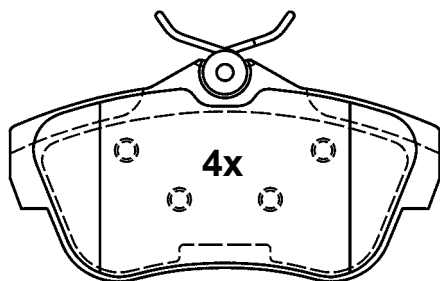

24578 16,5

4x

113,3 x 58,5 x 16,5



2x

M8x22



4x

## B1.G102-0940.2 G1020940



MERCEDES BENZ, VOLKSWAGEN



BOS

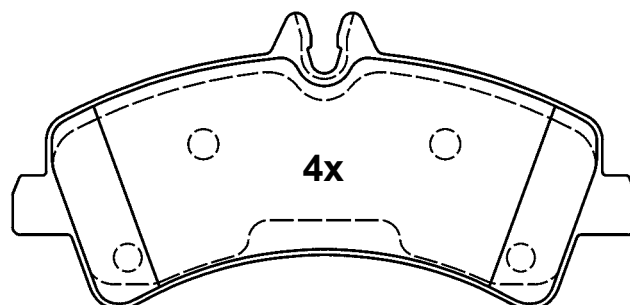

29217 20,5

4x

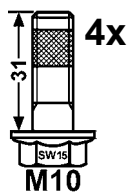

4x

M10

164,8 x 78,2 x 20,5

# Illustrations disc brake pads

Illustrations plaquettes de frein à disque / Illustrazioni pastiglie freno /  
Figuras Calços do travão de disco / Rysunki okładzin hamulców tarczowych /  
Zobrazení obložení kotoučových brzd

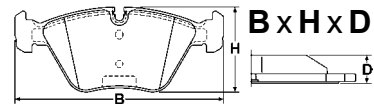

scale - échelle - scala - escala - skala - měřítko 1:2

## B1.G102-0946.2 G1020946



PEUGEOT



LUC

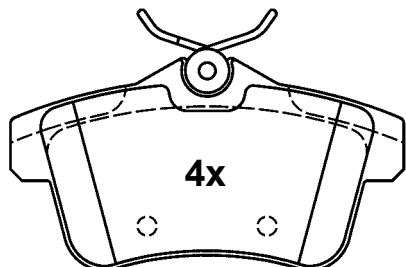

24922 17,5

103,8 x 55,6 x 17,5

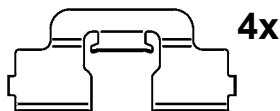

## B1.G102-0952.2 G1020952



FIAT, FORD



BOS

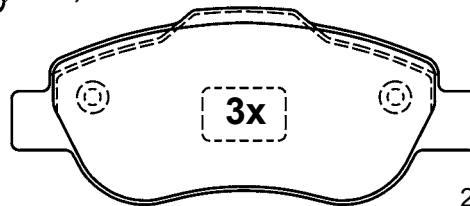

24072 17,9

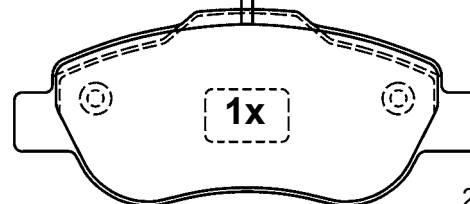
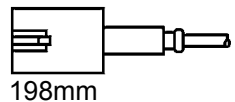

24764 17,9

122,8 x 51,7 x 17,9

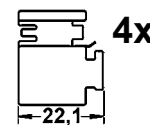
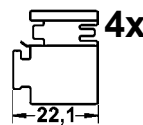
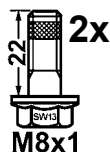

## B1.G102-0951.2 G1020951



FIAT, FORD



BOS

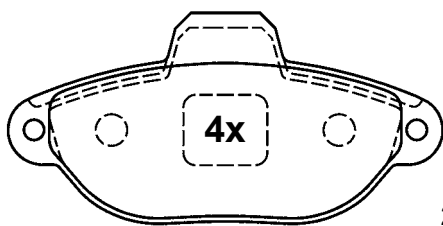

21436 17,0

114,8 x 55,5 x 17,0



## B1.G102-0953.2 G1020953



CHEVROLET, OPEL, VAUXHALL



ATE

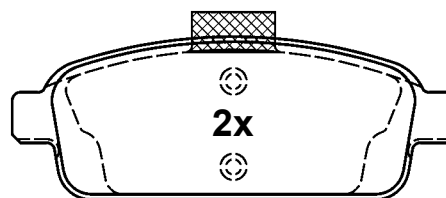

25096 17,0

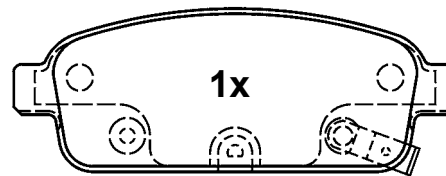

25097 17,0

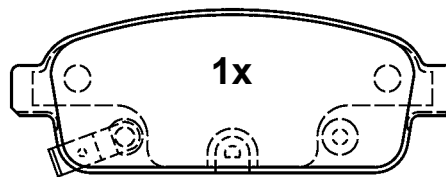

25098 17,0

116,5 x 42,7 x 17,0

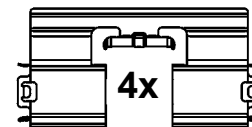





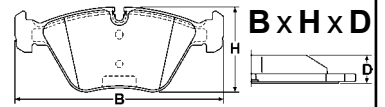



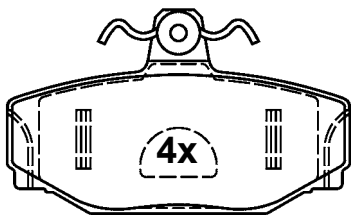

# Illustrations disc brake pads

Illustrations plaquettes de frein à disque / Illustrazioni pastiglie freno /  
 Figuras Calços do travão de disco / Rysunki okładzin hamulców tarczowych /  
 Zobrazení obložení kotoučových brzd

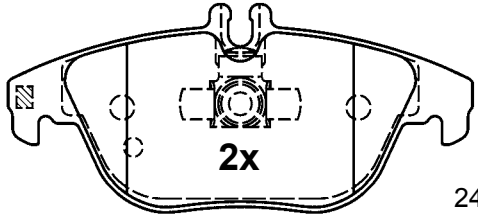
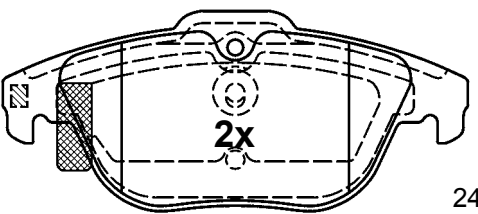

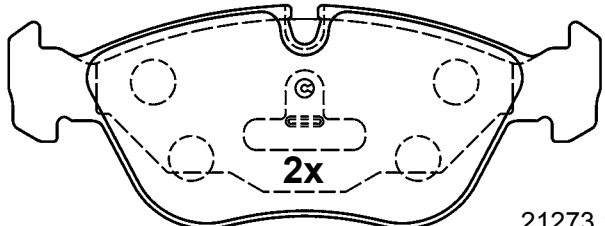
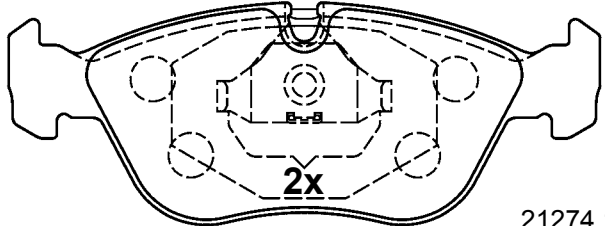
scale - échelle - scala - escala - skala - měřítko 1:2

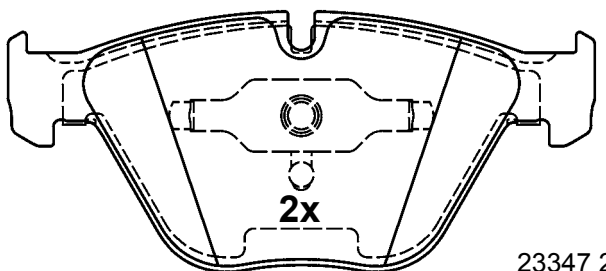
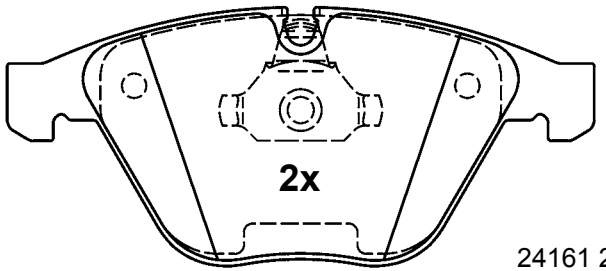





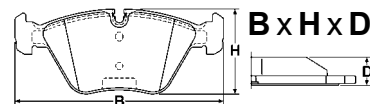

B1.G102-0955.2 G1020955	B1.G102-0963.2 G1020963
<p> VOLVO  LUC</p>  <p>21385 13,8</p> <p>4x</p>  2x M8x21 89,9 x 53,5 x 13,8	<p> MERCEDES BENZ  ATE</p>  <p>24253 17,8</p> <p>2x</p> <p>122,5 x 54,4 x 17,8</p>  <p>24254 18,0</p> <p>2x</p> <p>122,5 x 52,3 x 18,0</p>
B1.G102-0956.2 G1020956	B1.G102-0971.2 G1020971
<p> VOLVO  ATE</p>  <p>21273 19,5</p> <p>2x</p>  <p>21274 19,5</p> <p>156,3 x 58,5 x 19,5</p>	<p> BMW  ATE</p>  <p>23347 20,3</p> <p>2x</p>  <p>24161 20,3</p> <p>155,1 x 68,3 x 20,3</p>

# Illustrations disc brake pads

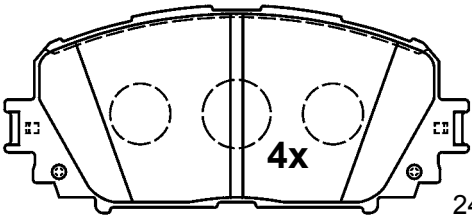
Illustrations plaquettes de frein à disque / Illustrazioni pastiglie freno /  
 Figuras Calços do travão de disco / Rysunki okładzin hamulców tarczowych /  
 Zobrazení obložení kotoučových brzd

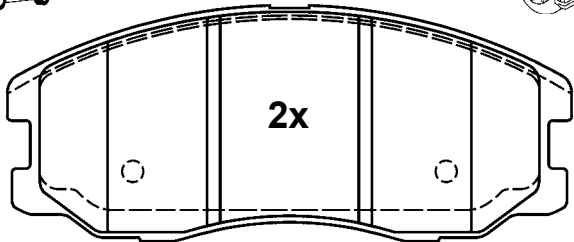
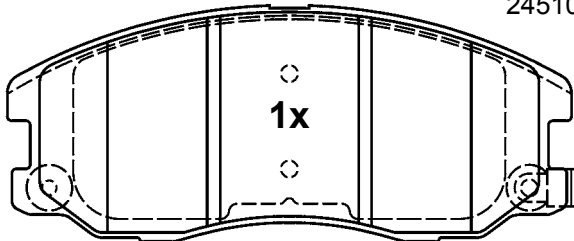
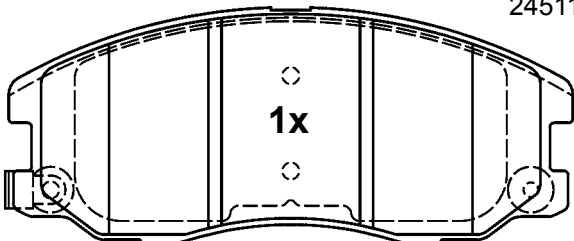

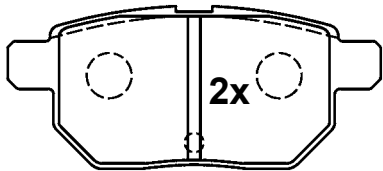
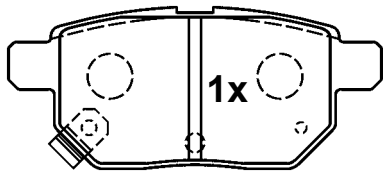
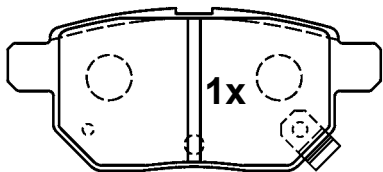
scale - échelle - scala - escala - skala - měřítko 1:2

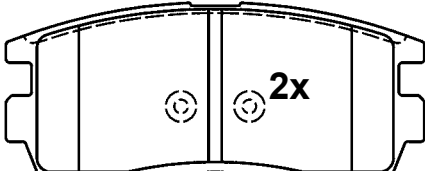
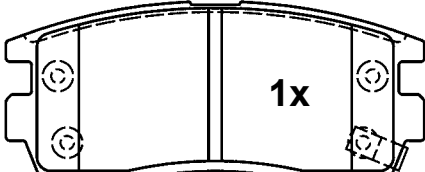
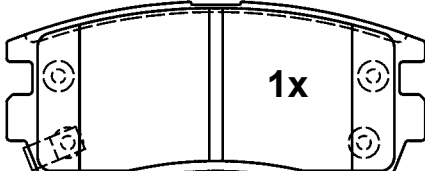
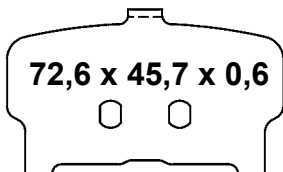
B1.G102-0974.2 G1020974	B1.G102-0979.2 G1020979
<p> TOYOTA </p>  <p>24347 17,5</p> <p>122,7 x 54,0 x 17,5</p>	<p> CHEVROLET, OPEL, VAUXHALL </p>  <p>24510 17,0</p>  <p>24511 17,0</p>  <p>24512 17,0</p> <p>148,9 x 61,9 x 17,0</p>
B1.G102-0975.2 G1020975	B1.G102-0981.2 G1020981
<p> SUBARU, TOYOTA </p>  <p>24612 15,0</p>  <p>24610 15,0</p>  <p>24611 15,0</p> <p>98,5 x 42,4 x 15,0</p>	<p> CHEVROLET, OPEL, VAUXHALL </p>  <p>24498 14,7</p>  <p>24499 14,7</p>  <p>24500 14,7</p> <p>110,4 x 46,0 x 14,7</p>  <p>72,6 x 45,7 x 0,6 4x</p>



# Illustrations disc brake pads

Illustrations plaquettes de frein à disque / Illustrazioni pastiglie freno /  
 Figuras Calços do travão de disco / Rysunki okładzin hamulców tarczowych /  
 Zobrazení obložení kotoučových brzd

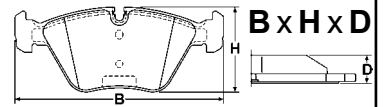

scale - échelle - scala - escala - skala - měřítko 1:2

<b>B1.G102-0983.2 G1020983</b>	<b>B1.G102-0985.2 G1020985</b>
--------------------------------	--------------------------------

AUDI LUC

24743 19,2  
(24408)

**188,0 x 73,5 x 19,2**

24409 19,2

**188,0 x 73,0 x 19,2**

MERCEDES BENZ ATE

24862 16,7

**141,1 x 59,6 x 16,7**

24863 16,7

**139,8 x 57,5 x 16,7**

**B1.G102-0987.2 G1020987**

FIAT BOS

23707 18,0

**122,9 x 53,3 x 18,0**

4x  
65  
M8

1x  
305mm

22  
M8x1  
2x

4x  
22,1

4x  
22,1

# Illustrations disc brake pads

Illustrations plaquettes de frein à disque / Illustrazioni pastiglie freno /  
 Figuras Calços do travão de disco / Rysunki okładzin hamulców tarczowych /  
 Zobrazení obložení kotoučových brzd

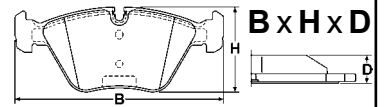

scale - échelle - scala - escala - skala - měřítko 1:2

<b>B1.G102-0988.2 G1020988</b>	<b>B1.G102-0992.2 G1020992</b>
--------------------------------	--------------------------------

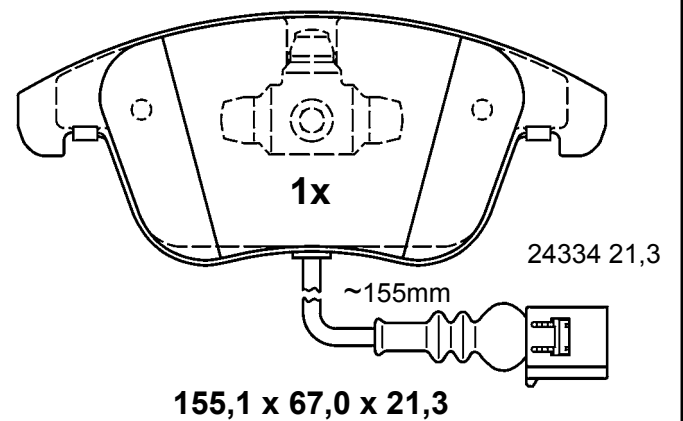
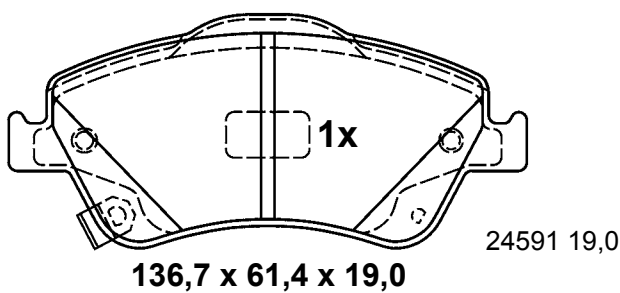
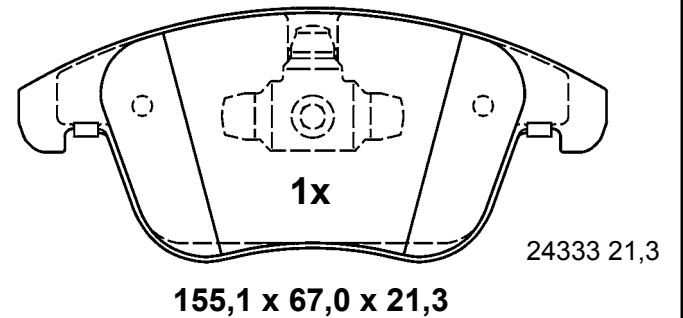
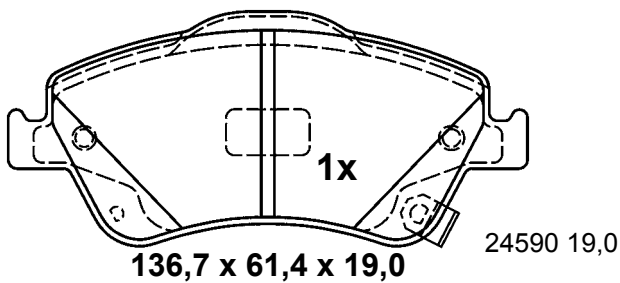
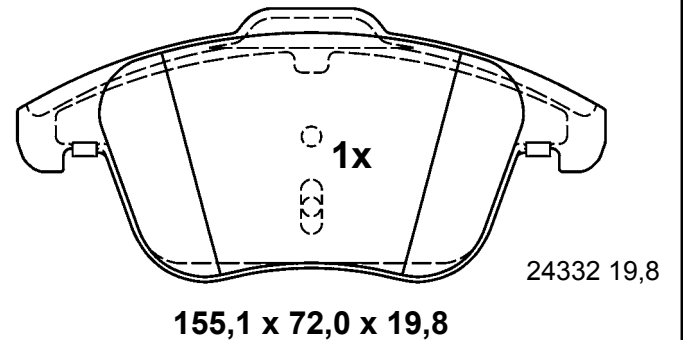
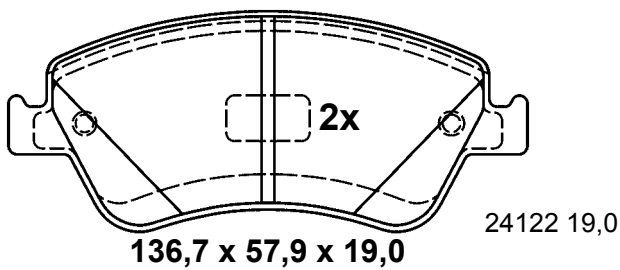
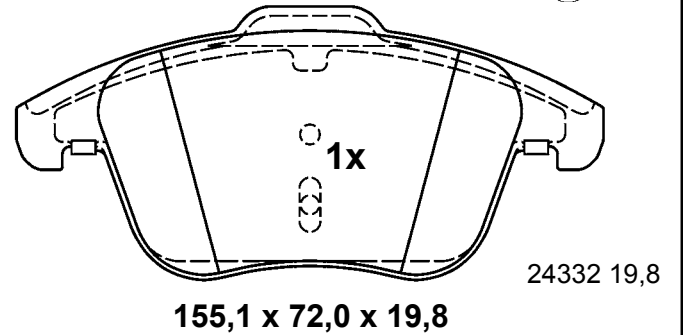
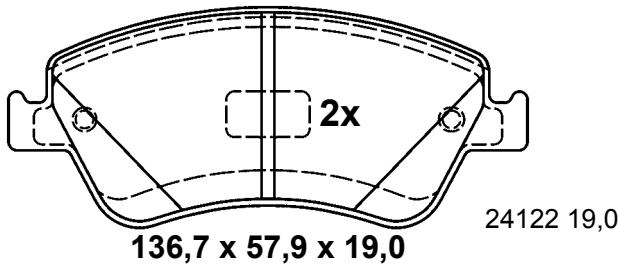



# Illustrations disc brake pads

Illustrations plaquettes de frein à disque / Illustrazioni pastiglie freno /  
Figuras Calços do travão de disco / Rysunki okładzin hamulców tarczowych /  
Zobrazení obložení kotoučových brzd

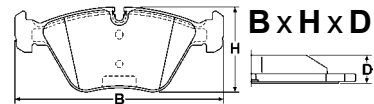

scale - échelle - scala - escala - skala - měřítko 1:2

## B1.G102-0993.2 G1020993



VOLKSWAGEN



LUC

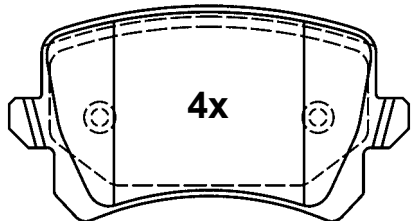

24483 16,9

105,2 x 56,4 x 16,9

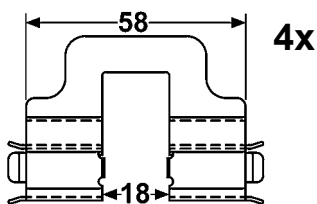

## B1.G102-0999.2 G1020999



PORSCHE



BRE

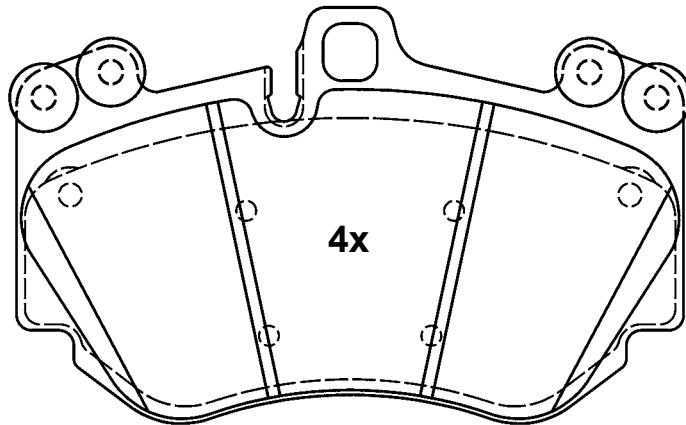

23961 16,8

## B1.G102-0994.2 G1020994



TOYOTA



176,0 x 109,6 x 16,8

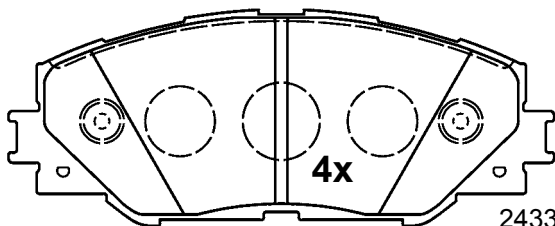

24337 17,5

146,4 x 56,8 x 17,5

## B1.G120-1000.2 G1201000



HONDA

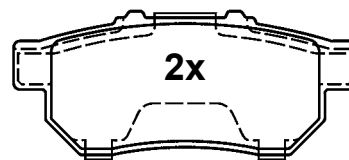

21738 13,5

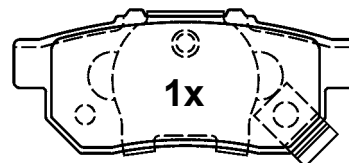

23343 13,5

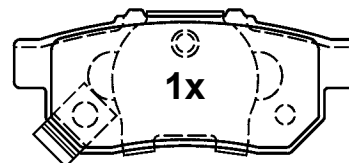

23344 13,5

## B1.G102-0995.2 G1020995



PEUGEOT



BOS

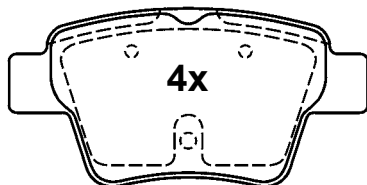

24150 17,6

94,8 x 46,9 x 17,6

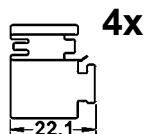
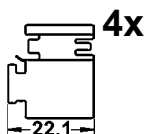
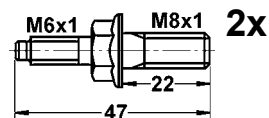

88,8 x 37,6 x 13,5

# Illustrations disc brake pads

Illustrations plaquettes de frein à disque / Illustrazioni pastiglie freno /  
 Figuras Calços do travão de disco / Rysunki okładzin hamulców tarczowych /  
 Zobrazení obložení kotoučových brzd

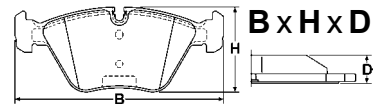

scale - échelle - scala - escala - skala - měřítko 1:2

## B1.G120-1002.2 G1201002



HYUNDAI, KIA

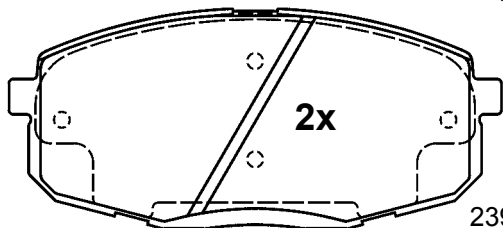

23966 17,7

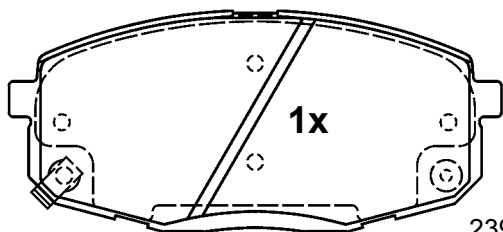

23987 17,7

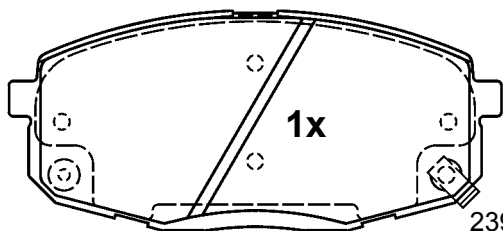

23988 17,7

130,0 x 57,9 x 17,7

## B1.G120-1005.2 G1201005



AUDI



LUC

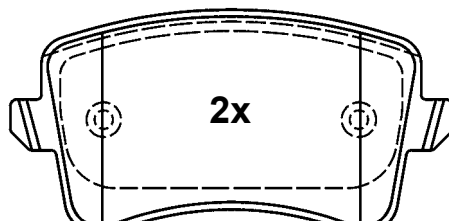

24606 17,4

116,4 x 58,5 x 17,4

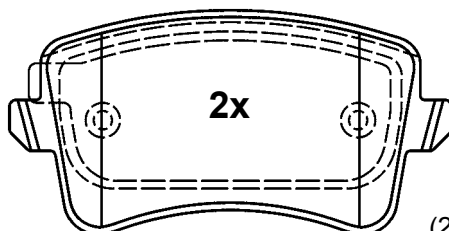

(24606) 17,7

116,4 x 58,5 x 17,7

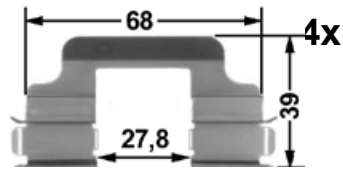

## B1.G120-1004.2 G1201004



AUDI



LUC

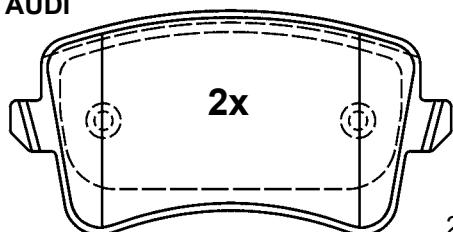

24606 17,4

116,4 x 58,5 x 17,4

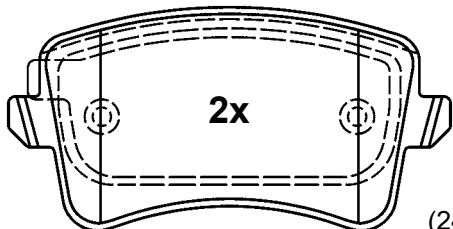

(24606) 17,7

116,4 x 58,5 x 17,7



## B1.G120-1009.2 G1201009



FORD, VOLVO



ATE

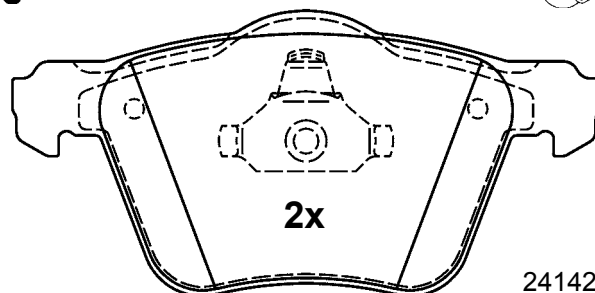

24142 20,6

155,1 x 75,3 x 20,6

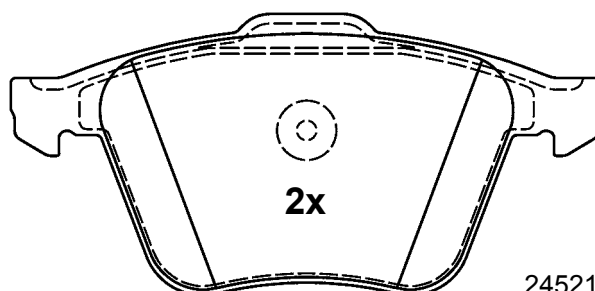

24521 19,1

156,4 x 74,3 x 19,1

# Illustrations disc brake pads

Illustrations plaquettes de frein à disque / Illustrazioni pastiglie freno /  
Figuras Calços do travão de disco / Rysunki okładzin hamulców tarczowych /  
Zobrazení obložení kotoučových brzd

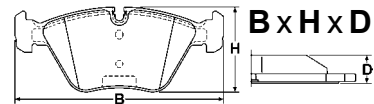

scale - échelle - scala - escala - skala - měřítko 1:2

## B1.G120-1010.2 G1201010



VOLKSWAGEN



BRE

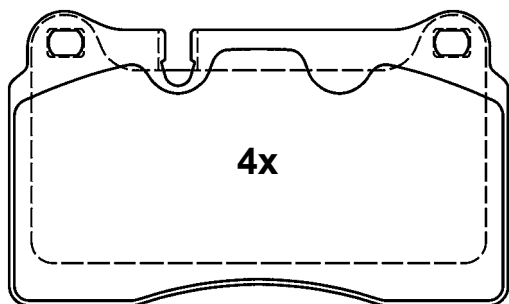

4x

24098 17,1

131,6 x 77,3 x 17,1

## B1.G120-1013.2 G1201013



HONDA

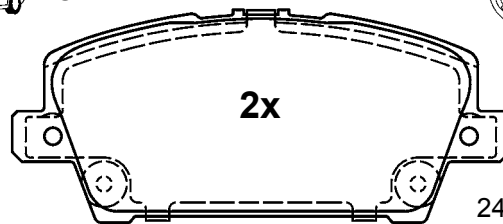

2x

24087 17,4

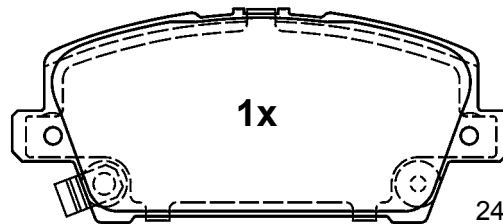

1x

24405 17,4

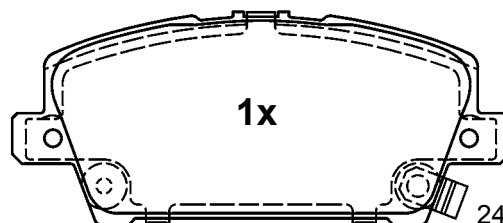

1x

24405 17,4

131,5 x 55,7 x 17,4



2x

M8x22

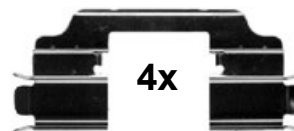

4x

## B1.G120-1011.2 G1201011



VOLKSWAGEN



BRE

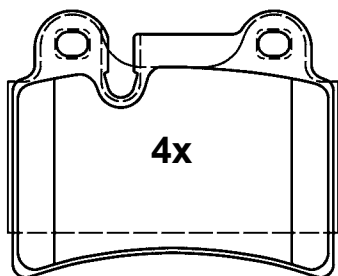

4x

24097 17,1

86,8 x 70,1 x 17,1

## B1.G120-1014.2 G1201014



HONDA

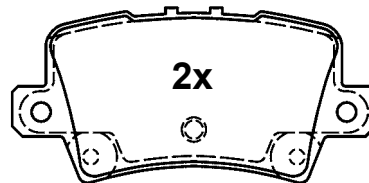

2x

24086 15,8



4x

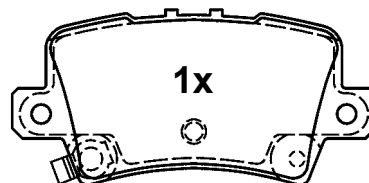

1x

24519 15,8

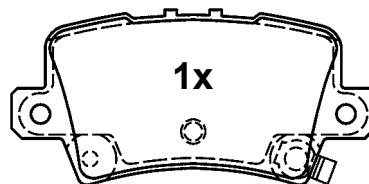

1x

24518 15,8



2x

M8x22

95,7 x 46,2 x 15,8

# Illustrations disc brake pads

Illustrations plaquettes de frein à disque / Illustrazioni pastiglie freno /  
 Figuras Calços do travão de disco / Rysunki okładzin hamulców tarczowych /  
 Zobrazení obložení kotoučových brzd

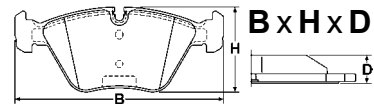

scale - échelle - scala - escala - skala - měřítko 1:2

<b>B1.G120-1022.2 G1201022</b>	<b>B1.G120-1029.2 G1201029</b>
--------------------------------	--------------------------------

**LEXUS, TOYOTA** **AKE**

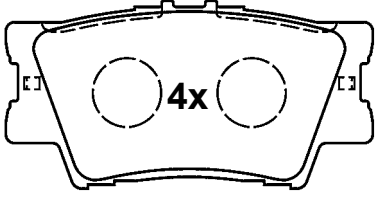

24338 15,5

**96,6 x 49,2 x 15,5**

**NISSAN, RENAULT** **SUM**

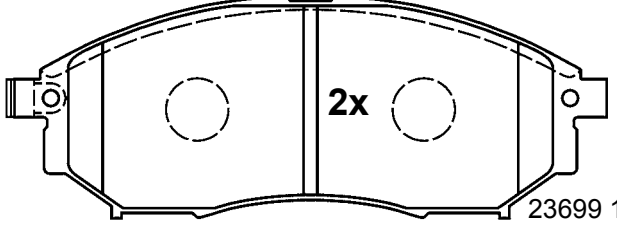

23699 16,8

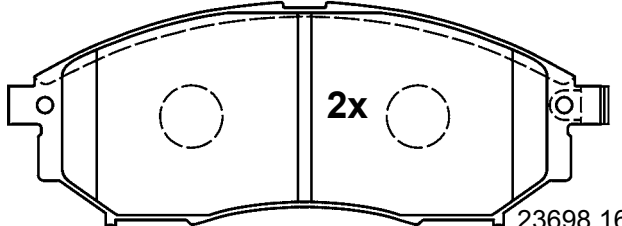

23698 16,8

**157,0 x 58,5 x 16,8**

<b>B1.G120-1025.2 G1201025</b>	<b>B1.G120-1033.2 G1201033</b>
--------------------------------	--------------------------------

**KIA** **AKE**

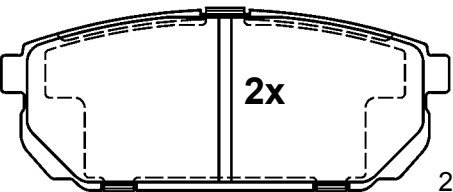

24092 17,1

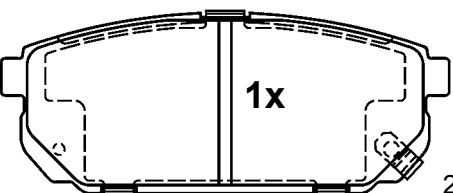

24178 17,1

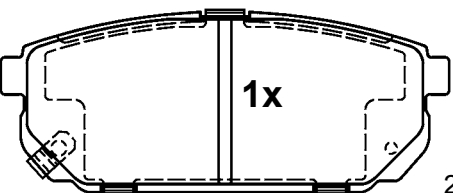

24179 17,1

**154,8 x 60,1 x 17,1**

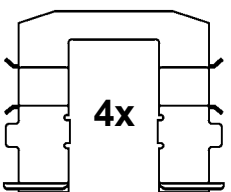

**4x**

**HYUNDAI, KIA** **SUM**

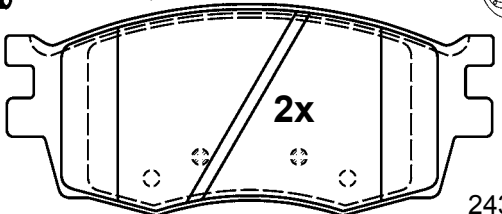

24317 17,6

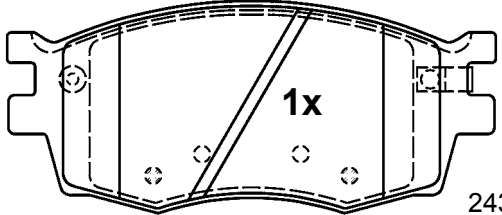

24318 17,6

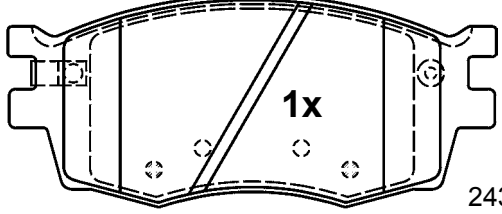

24319 17,6

**129,6 x 55,9 x 17,6**



**4x**



# Illustrations disc brake pads

Illustrations plaquettes de frein à disque / Illustrazioni pastiglie freno /  
 Figuras Calços do travão de disco / Rysunki okładzin hamulców tarczowych /  
 Zobrazení obložení kotoučových brzd

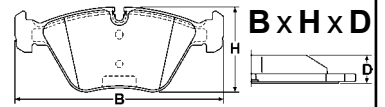

scale - échelle - scala - escala - skala - měřítko 1:2

## B1.G120-1035.2 G1201035



HYUNDAI, KIA

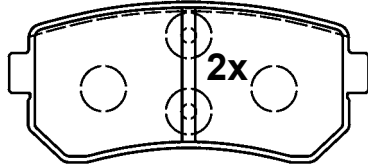

24320 15,3

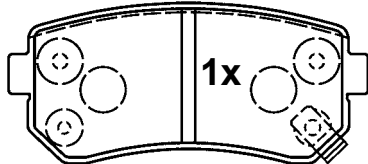

24321 15,3

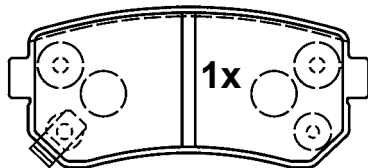

24322 15,3

93,1 x 41,0 x 16,0

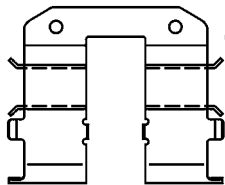

4x

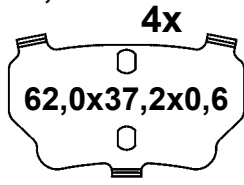

4x

62,0x37,2x0,6

## B1.G120-1053.2 G1201053



DAIHATSU, FORD, MAZDA,  
SUBARU

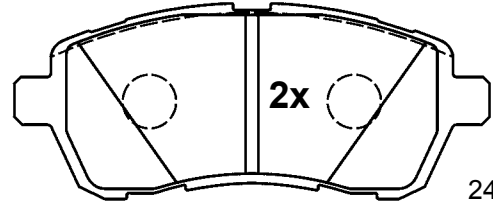

24283 15,5

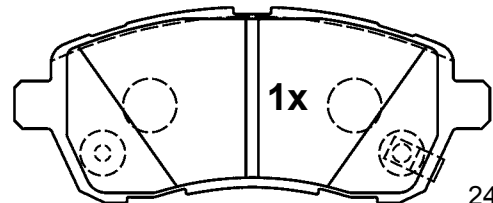

24284 15,5

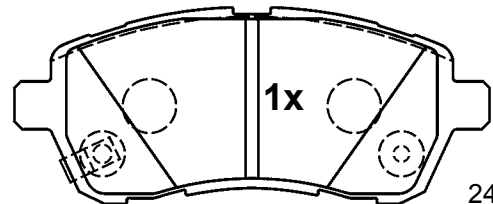

24285 15,5

125,4 x 51,4 x 15,5

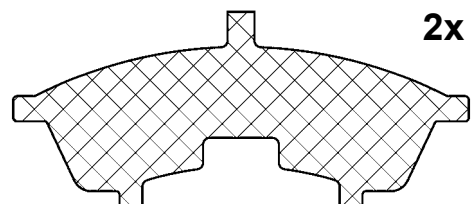

2x

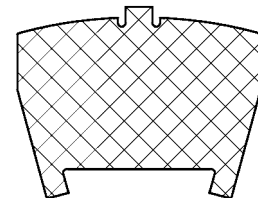

2x

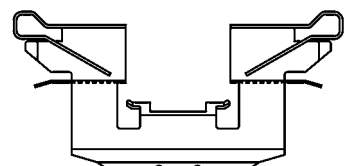

4x

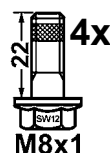

22 4x

M8x1

## B1.G120-1047.2 G1201047



HYUNDAI, KIA

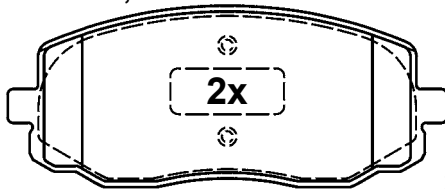

24275 16,5

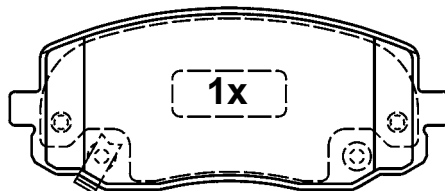

24410 16,5

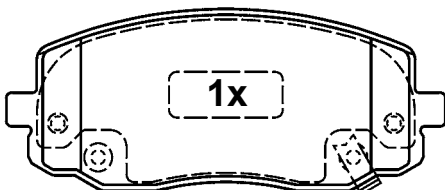

24411 16,5

115,9 x 47,3 x 16,5



4x

# Illustrations disc brake pads

Illustrations plaquettes de frein à disque / Illustrazioni pastiglie freno /  
Figuras Calços do travão de disco / Rysunki okładzin hamulców tarczowych /  
Zobrazení obložení kotoučových brzd

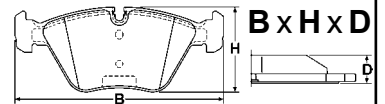

scale - échelle - scala - escala - skala - měřítko 1:2

## B1.G120-1056.2 G1201056

SUZUKI

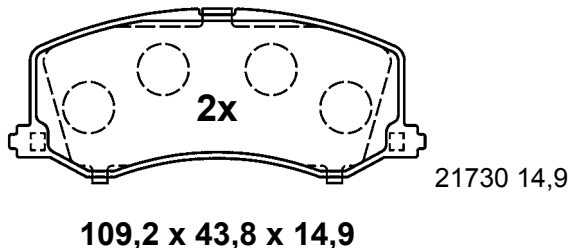
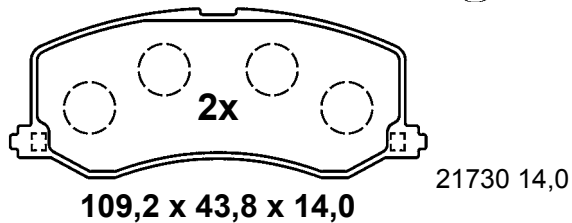

1x

## B1.G120-1059.2 G1201059

NISSAN, OPEL, SUZUKI,  
VAUXHALL

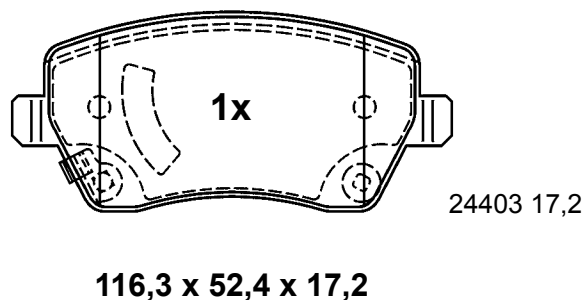
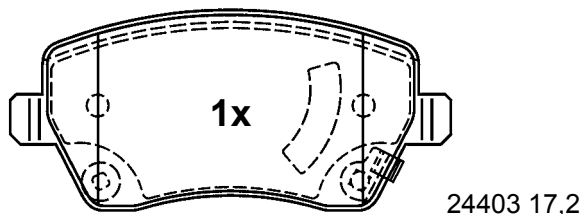
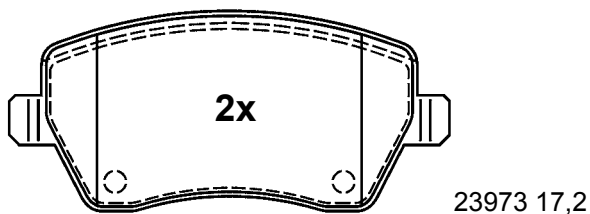

## B1.G120-1065.2 G1201065

LEXUS, SUBARU, TOYOTA

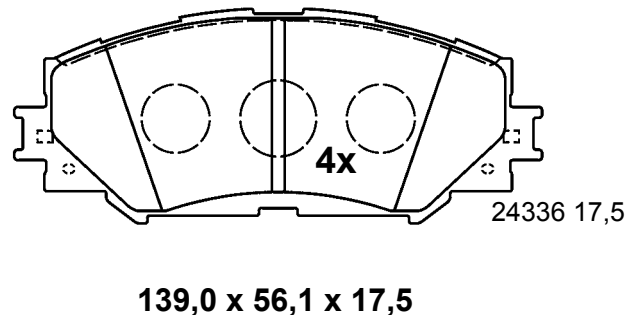

## B1.G120-1066.2 G1201066

PORSCHE

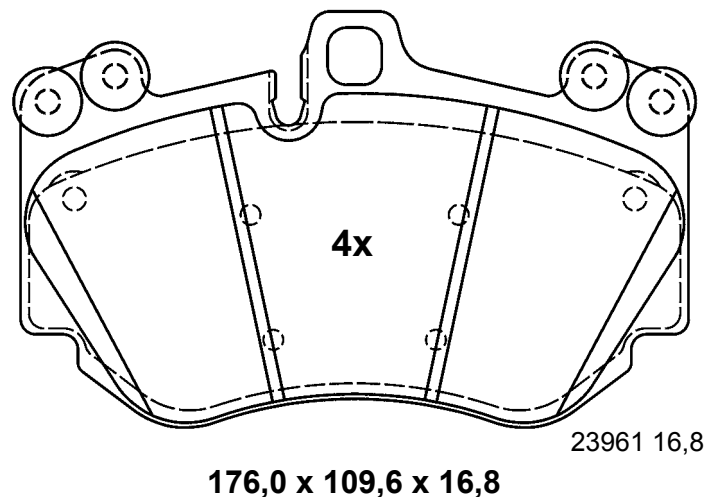

## B1.G120-1069.2 G1201069

PEUGEOT

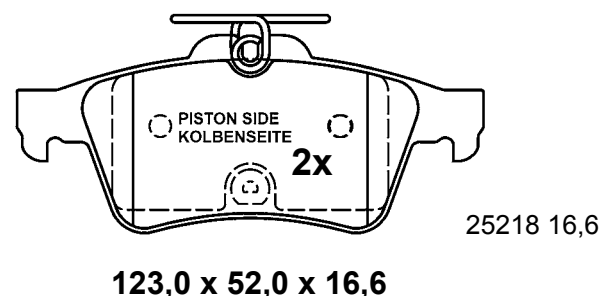
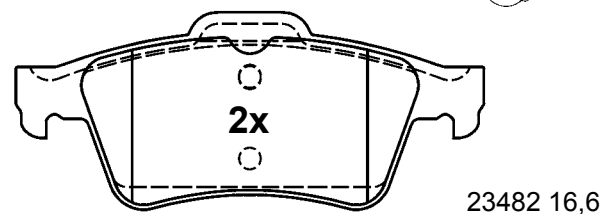

# Illustrations disc brake pads

Illustrations plaquettes de frein à disque / Illustrazioni pastiglie freno /  
Figuras Calços do travão de disco / Rysunki okładzin hamulców tarczowych /  
Zobrazení obložení kotoučových brzd

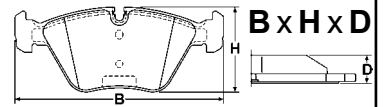

scale - échelle - scala - escala - skala - měřítko 1:2

## B1.G120-1070.2 G1201070



PEUGEOT



ATE

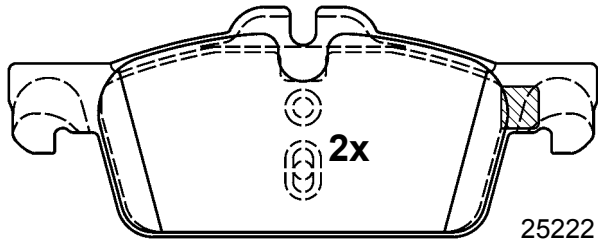

155,1 x 60,3 x 17,3

25222 17,3

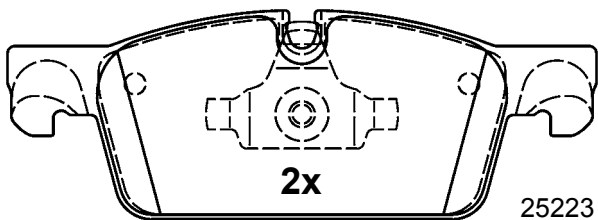

155,1 x 55,0 x 17,3

25223 17,3

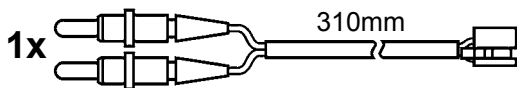

## B1.G120-1079.2 G1201079



PORSCHE, VOLKSWAGEN



BRE

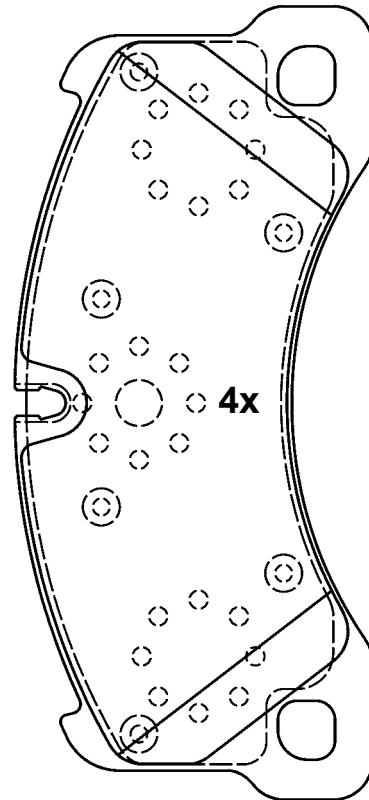

24553 15,8

209,5 x 94,2 x 15,8

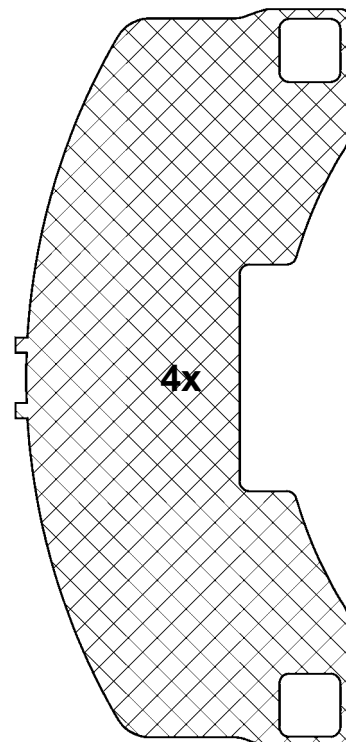

## B1.G120-1073.2 G1201073



PEUGEOT



ATE

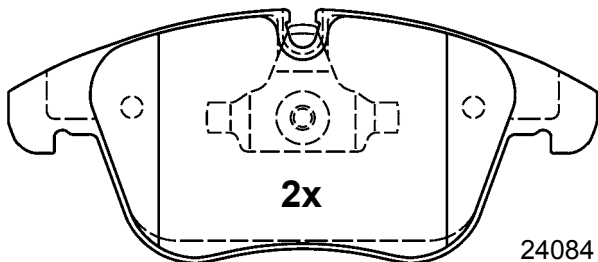

155,1 x 66,5 x 19,3

24084 19,3

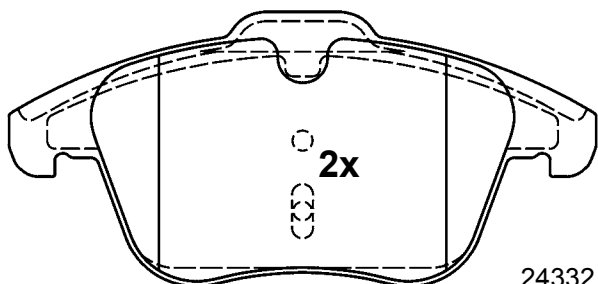

155,1 x 72,0 x 18,3

24332 18,3

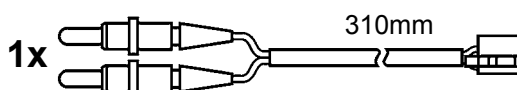

# Illustrations disc brake pads

Illustrations plaquettes de frein à disque / Illustrazioni pastiglie freno /  
 Figuras Calços do travão de disco / Rysunki okładzin hamulców tarczowych /  
 Zobrazení obložení kotoučových brzd

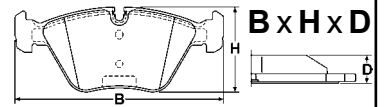

scale - échelle - scala - escala - skala - měřítko 1:2

## B1.G120-1085.2 G1201085

SUZUKI

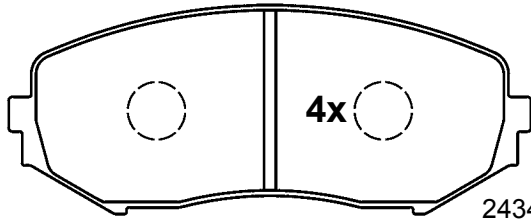

24346 16,4

138,0 x 54,7 x 16,4

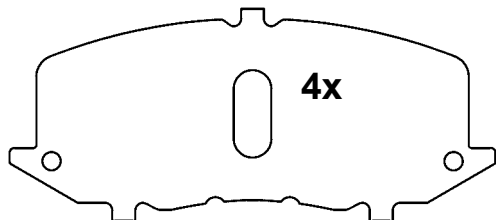

128,0 x 48,6 x 0,7

1x

## B1.G120-1128.2 G1201128

FIAT, LANCIA

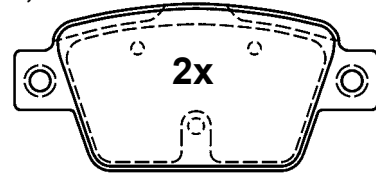

23714 17,6

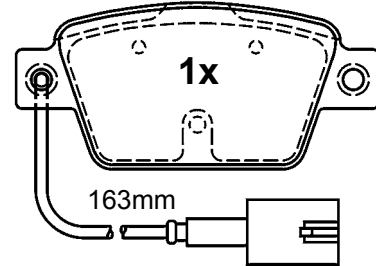

17,6

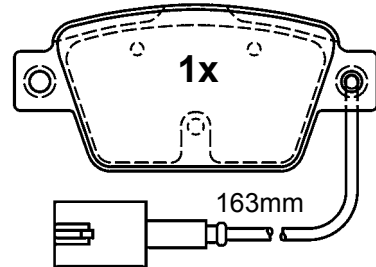

17,6

94,8 x 42,9 x 17,6

## B1.G120-1126.2 G1201126

DACIA, RENAULT

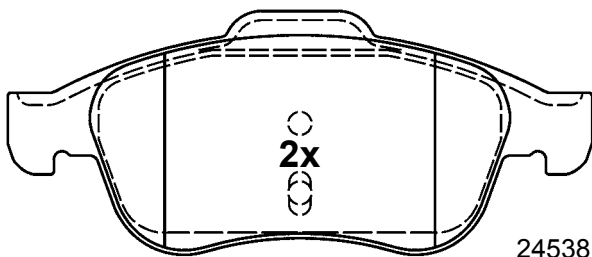

24538 17,9

155,1 x 64,7 x 17,9

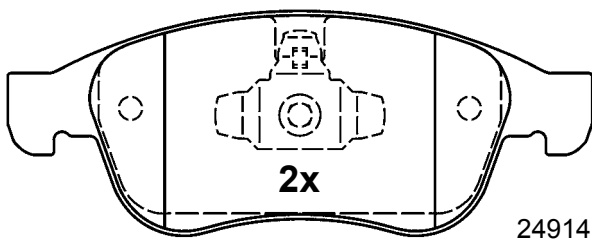

24914 17,9

155,1 x 59,4 x 17,9

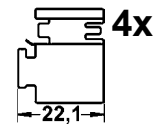
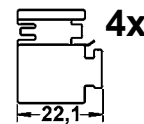
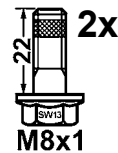

## B1.G120-1135.2 G1201135

VOLVO

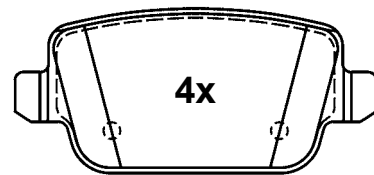

24537 15,8

95,1 x 43,2 x 15,8

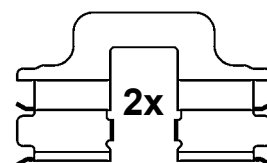
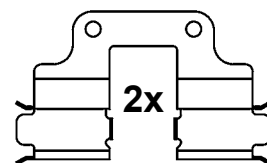



# Illustrations disc brake pads

Illustrations plaquettes de frein à disque / Illustrazioni pastiglie freno /  
 Figuras Calços do travão de disco / Rysunki okładzin hamulców tarczowych /  
 Zobrazení obložení kotoučových brzd

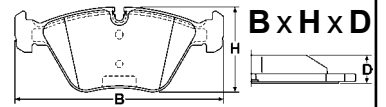

scale - échelle - scala - escala - skala - měřítko 1:2

## B1.G120-1143.2 G1201143



OPEL, SAAB, VAUXHALL



MAN

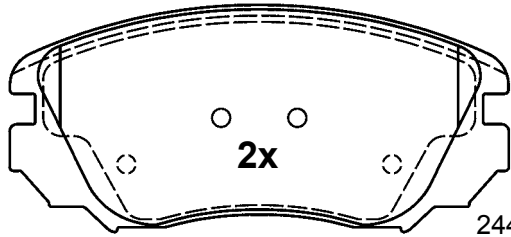

24415 19,1

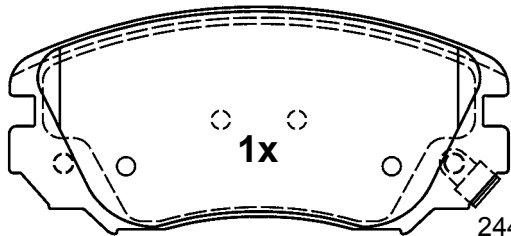

24416 19,1

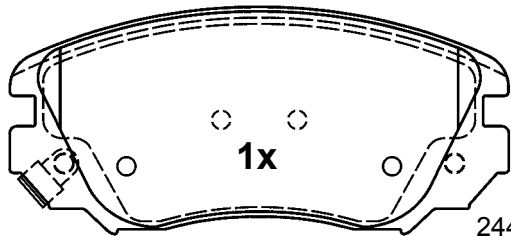

24417 19,1

131,4 x 59,7 x 19,1

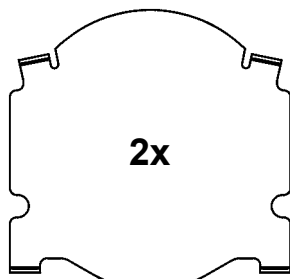

2x

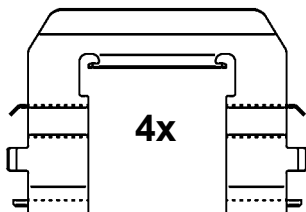

4x

## B1.G120-1145.2 G1201145



OPEL, SAAB, VAUXHALL



MAN

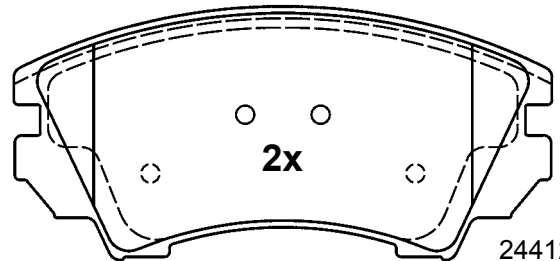

24412 19,0

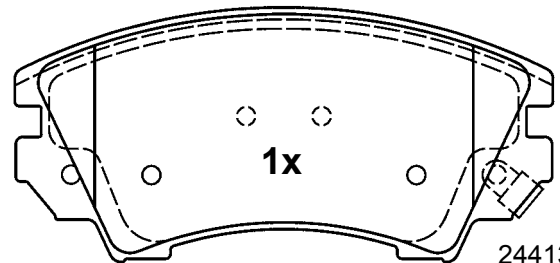

24413 19,0

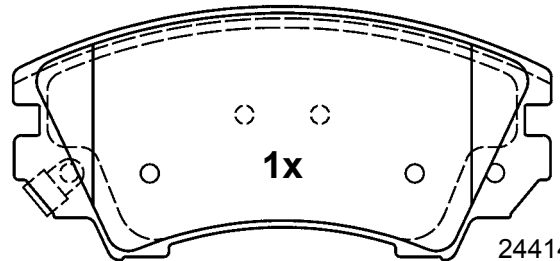

24414 19,0

141,9 x 66,7 x 19,0

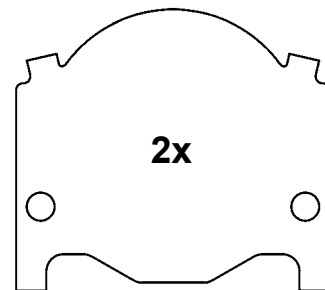

2x

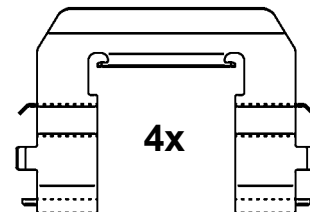

4x

# Illustrations disc brake pads

Illustrations plaquettes de frein à disque / Illustrazioni pastiglie freno /  
 Figuras Calços do travão de disco / Rysunki okładzin hamulców tarczowych /  
 Zobrazení obložení kotoučových brzd

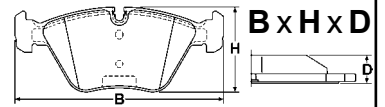

scale - échelle - scala - escala - skala - měřítko 1:2

B1.G120-1147.2 G1201147	B1.G120-1148.2 G1201148
-------------------------	-------------------------

OPEL, SAAB, VAUXHALL LUC

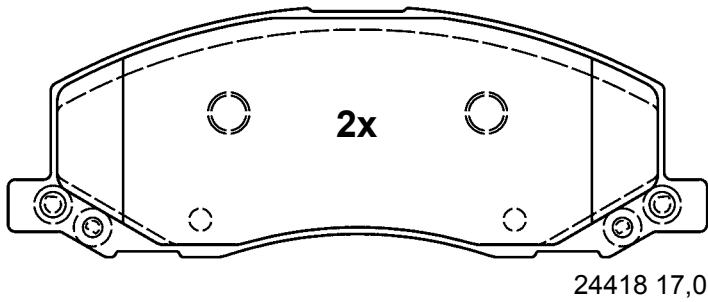

24418 17,0

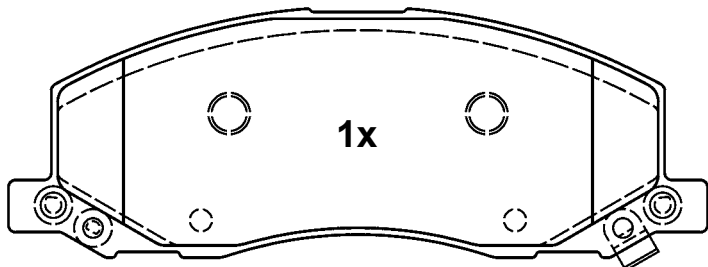

24419 17,0

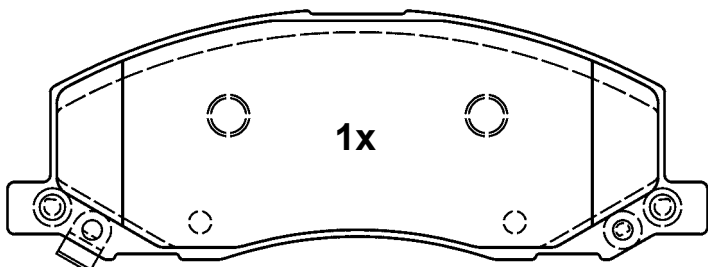

24410 17,0

184,5 x 65,4 x 17,0

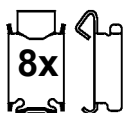

OPEL, VAUXHALL LUC

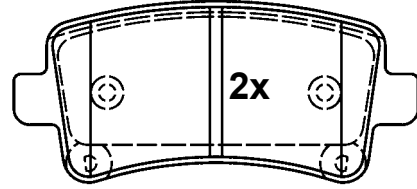

24421 17,2

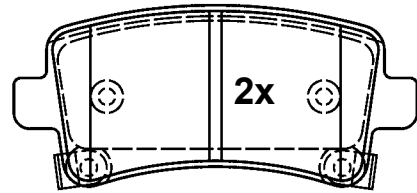

24422 17,2

106,3 x 47,1 x 17,2

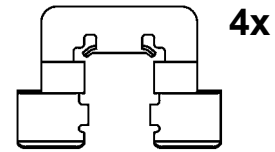

B1.G120-1149.2 G1201149
-------------------------

OPEL, VAUXHALL LUC

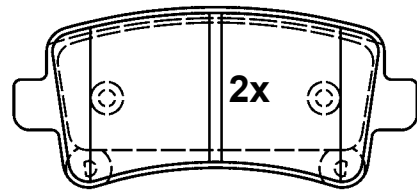

24421 17,2

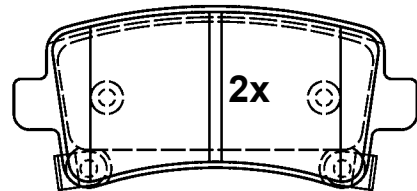

24422 17,2

106,3 x 47,1 x 17,2

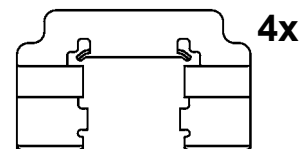

# Illustrations disc brake pads

Illustrations plaquettes de frein à disque / Illustrazioni pastiglie freno /  
Figuras Calços do travão de disco / Rysunki okładzin hamulców tarczowych /  
Zobrazení obložení kotoučových brzd

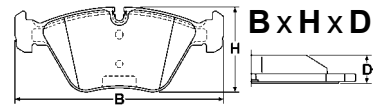

scale - échelle - scala - escala - skala - měřítko 1:2

## B1.G120-1209.2 G1201209



TOYOTA



BOS

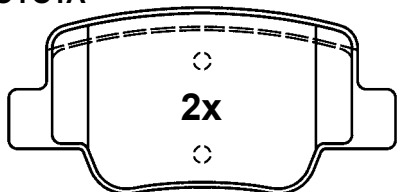

2x

24926 16,5

101,8 x 48,7 x 16,5

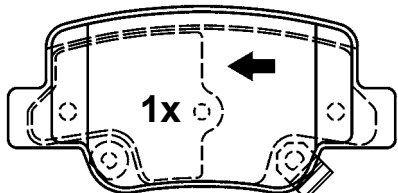

1x

24927 17,1

101,8 x 48,7 x 17,1

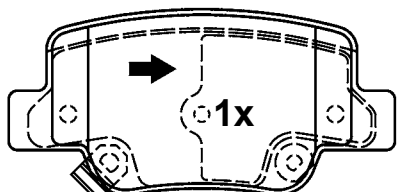

1x

24928 17,1

101,8 x 48,7 x 17,1

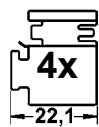

## B1.G120-1224.2 G1201224



ALFA ROMEO, FIAT



BOS

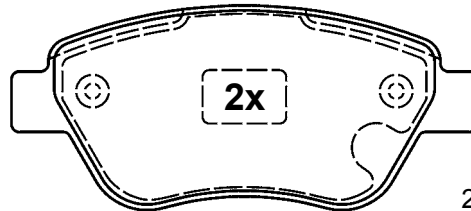

2x

23707 18,0

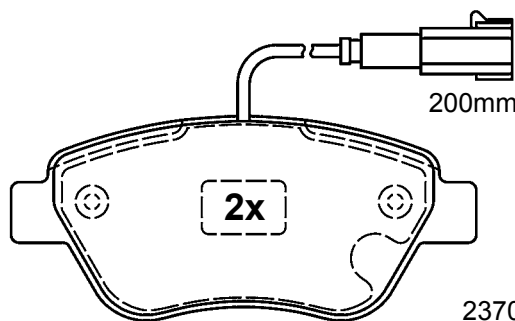

200mm

23706 18,0

122,8 x 53,3 x 18,0

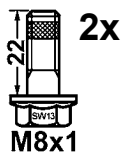

2x

M8x1

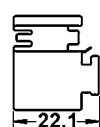

4x

22,1

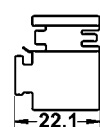

4x

22,1

## B1.G120-1213.2 G1201213



BMW



LUC

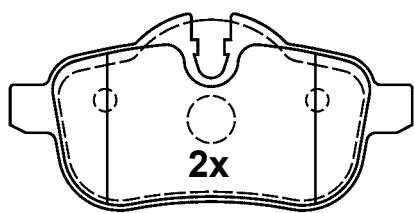

2x

24559 17,8

106,0 x 52,3 x 17,8

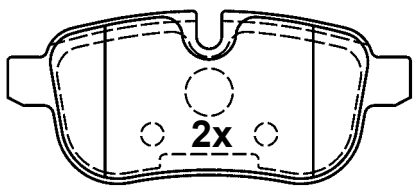

2x

24560 17,8

106,0 x 45,1 x 17,8



2x

M8x21

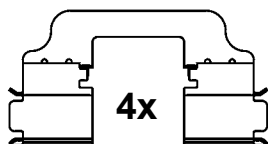

4x

## B1.G120-1225.2 G1201225



FIAT



BOS

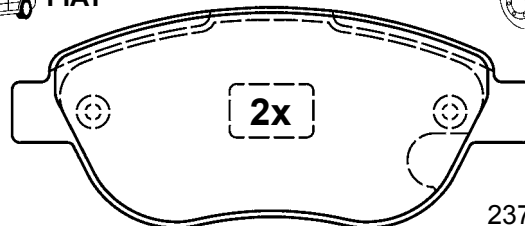

2x

23710 19,0

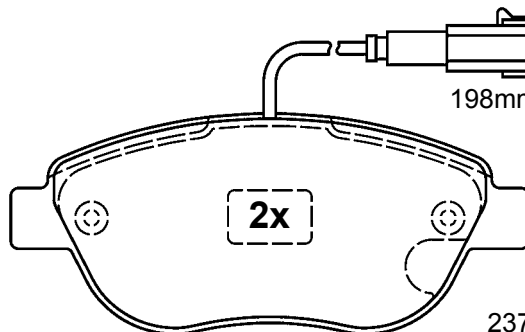

198mm

23709 19,0

136,8 x 57,4 x 19,0

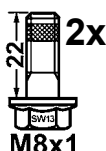

2x

M8x1



4x

22,1

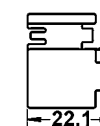

4x

22,1

# Illustrations disc brake pads

Illustrations plaquettes de frein à disque / Illustrazioni pastiglie freno /  
 Figuras Calços do travão de disco / Rysunki okładzin hamulców tarczowych /  
 Zobrazení obložení kotoučových brzd

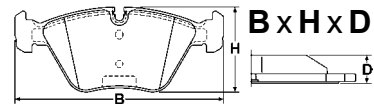

scale - échelle - scala - escala - skala - měřítko 1:2

<b>B1.G120-1272.2 G1201272</b>	<b>B1.G120-5215.2 G1205215</b>
--------------------------------	--------------------------------

**MERCEDES BENZ**

**CHRYSLER**

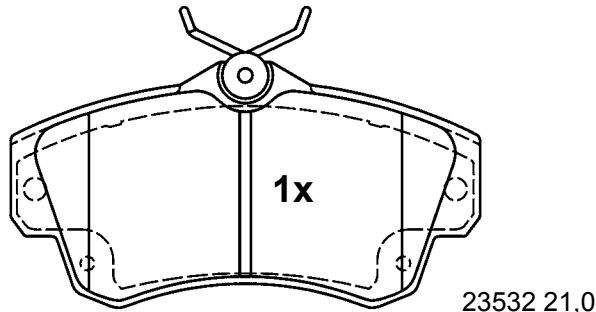
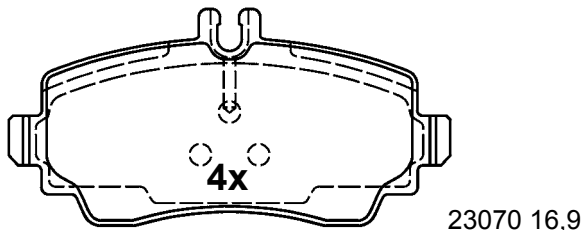

**116,5 x 57,1 x 16,9**

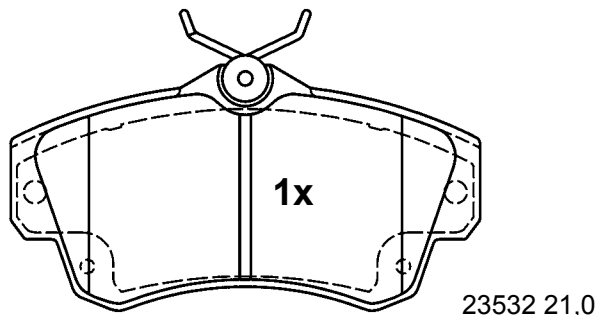
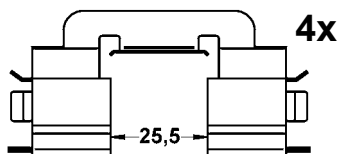
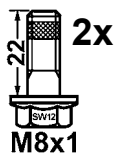

<b>B1.G120-5203.2 G1205203</b>	
--------------------------------	--

**CHRYSLER**

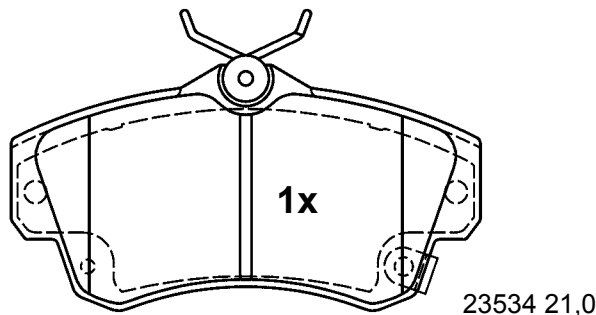
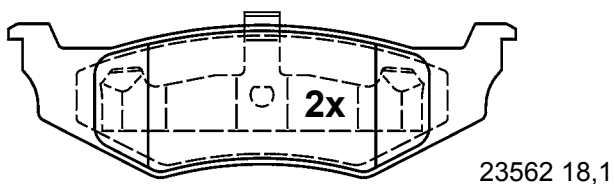
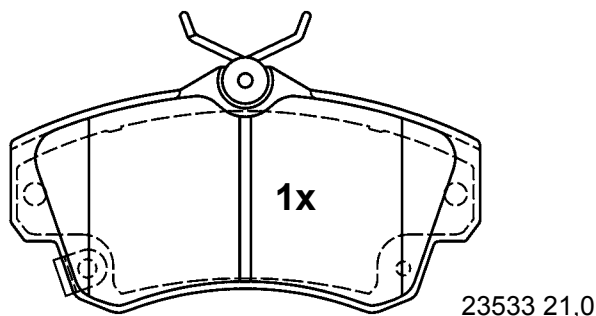
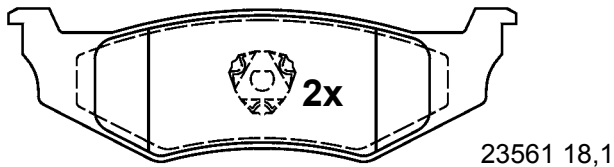

**133,6 x 39,9 x 18,1**



**123,9 x 64,6 x 21,0**

# Illustrations disc brake pads

Illustrations plaquettes de frein à disque / Illustrazioni pastiglie freno /  
 Figuras Calços do travão de disco / Rysunki okładzin hamulców tarczowych /  
 Zobrazení obložení kotoučových brzd

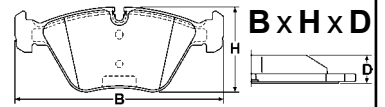

scale - échelle - scala - escala - skala - měřítko 1:2

<b>B1.G120-5230.2 G1205230</b>	<b>B1.G120-5238.2 G1205238</b>
--------------------------------	--------------------------------

CHRYSLER, CITROEN, JEEP  
LANCIA, MITSUBISHI, PEUGEOT

CHRYSLER, JEEP LUC

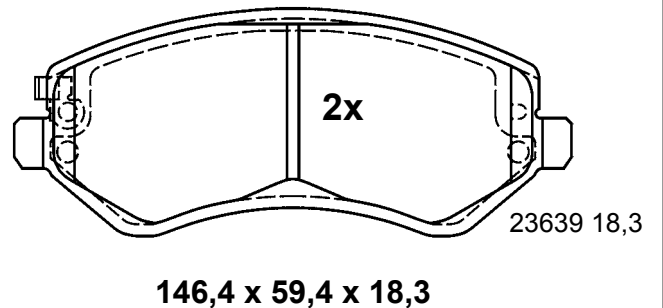
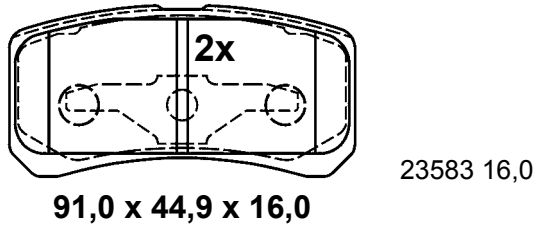
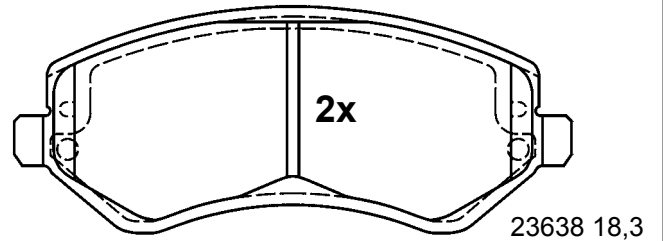
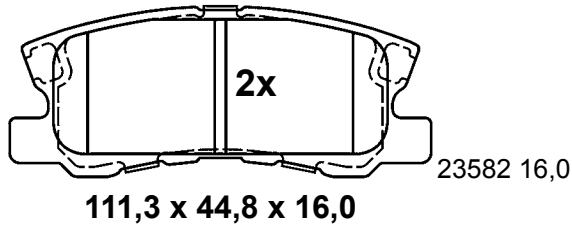

<b>B1.G120-5234.2 G1205234</b>	<b>B1.G120-5241.2 G1205241</b>
--------------------------------	--------------------------------

CHRYSLER, JEEP

CHRYSLER, JEEP, MITSUBISHI AKE

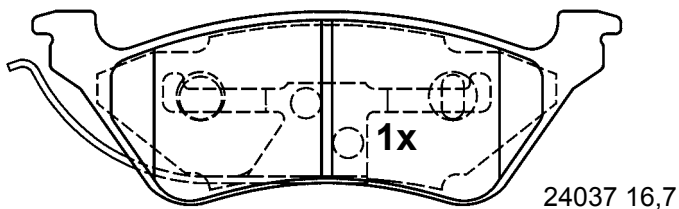
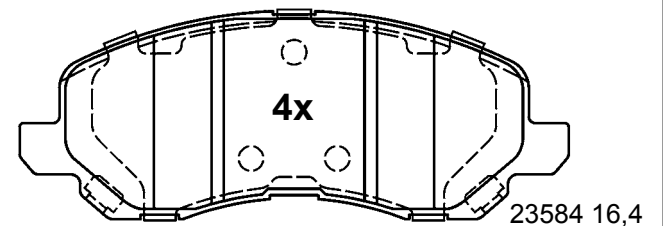
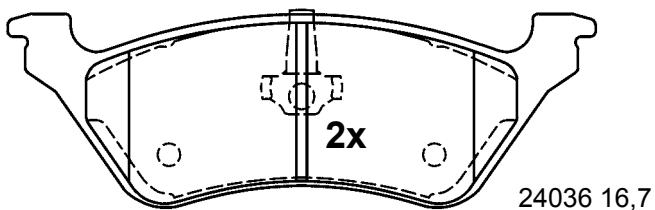

**144,8 x 54,9 x 16,4**

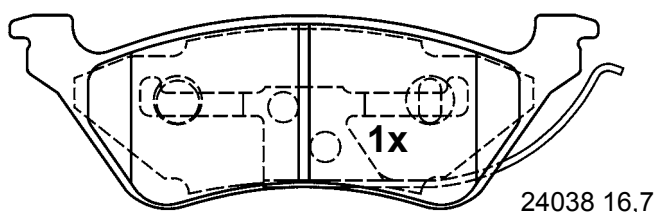

**155,4 x 50,8 x 16,7**

# Illustrations disc brake pads

Illustrations plaquettes de frein à disque / Illustrazioni pastiglie freno /

Figuras Calços do travão de disco / Rysunki okładzin hamulców tarczowych /

Zobrazení obložení kotoučových brzd

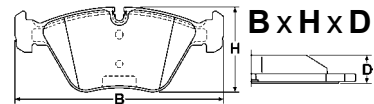

scale - échelle - scala - escala - skala - měřítko 1:2

## B1.G120-5242.2 G1205242

TOYOTA

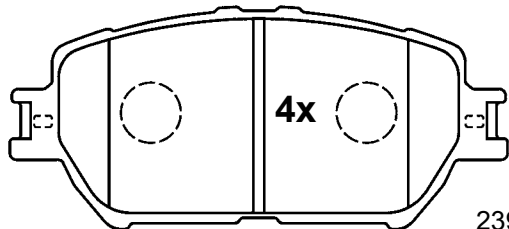

23928 17,3

131,4 x 58,5 x 17,3

## B1.G120-5344.2 G1205344

HONDA



SUM

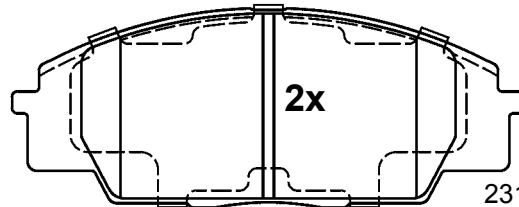

23178 16,6

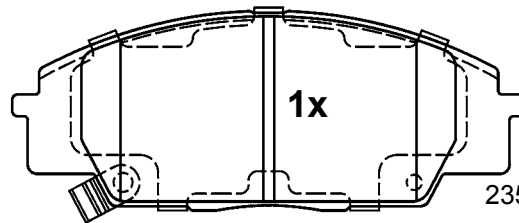

23530 16,6

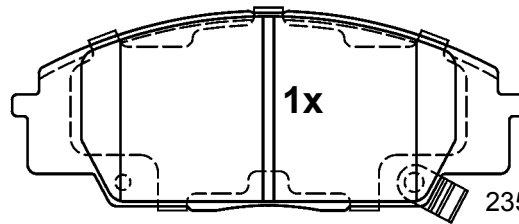

23531 16,6

135,3 x 52,4 x 16,6

## B1.G120-5333.2 G1205333

LEXUS, MITSUBISHI, TOYOTA

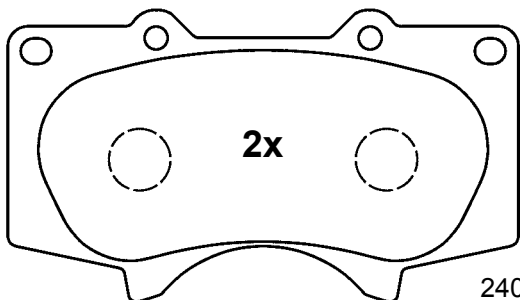

24024 17,0

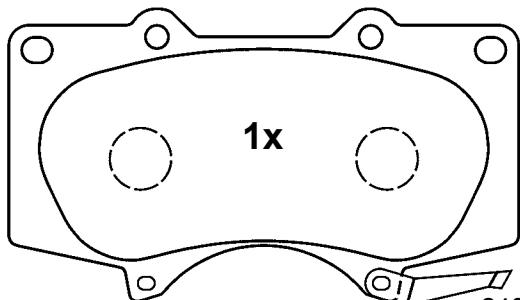

24026 17,0

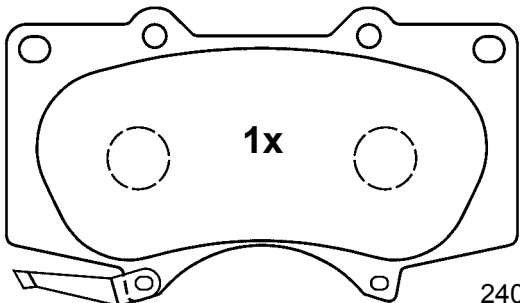

24025 17,0

134,2 x 76,9 x 17,0

## B1.G120-5352.2 G1205352

FORD, MAZDA



ATE

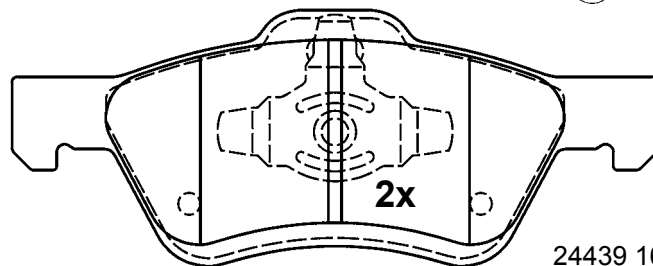

24439 16,1

170,4 x 67,3 x 16,1

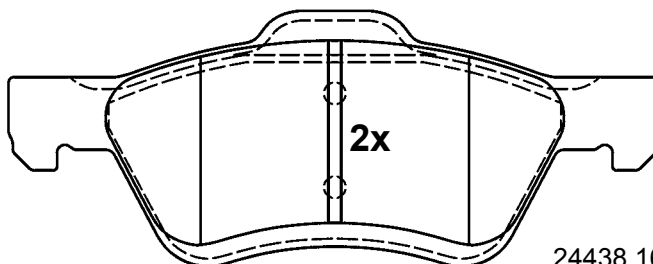

24438 16,1

172,4 x 67,3 x 16,1

# Illustrations disc brake pads

Illustrations plaquettes de frein à disque / Illustrazioni pastiglie freno /  
 Figuras Calços do travão de disco / Rysunki okładzin hamulców tarczowych /  
 Zobrazení obložení kotoučových brzd

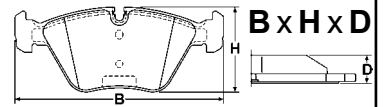

scale - échelle - scala - escala - skala - měřítko 1:2

## B1.G120-5366.2 G1205366



CHRYSLER



ATE

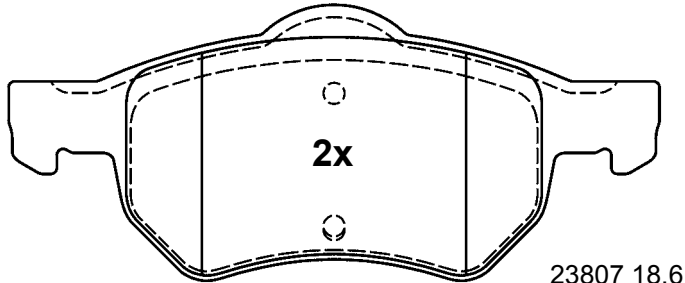

23807 18,6

172,2 x 72,5 x 18,6

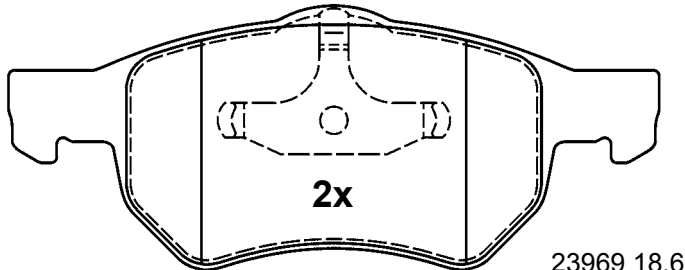

23969 18,6

172,2 x 69,2 x 18,6

## B1.G120-5418.2 G1205418



SUBARU



TOK

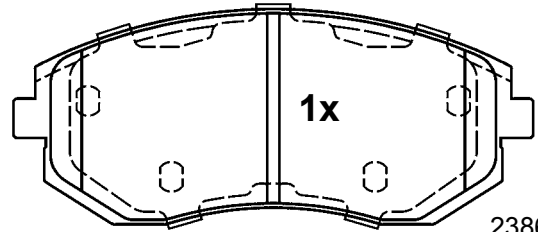

23865 17,6

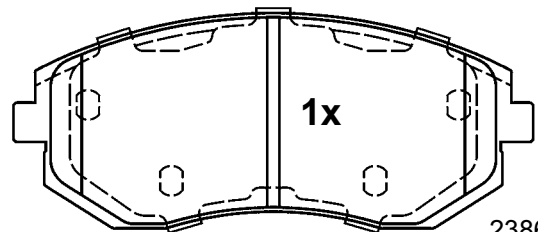

23865 17,6

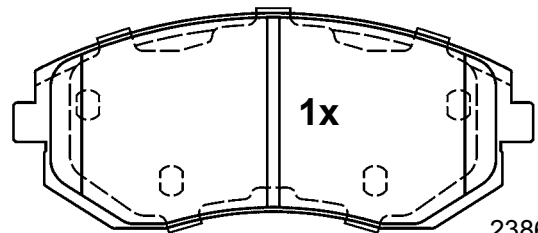

23865 17,6

## B1.G120-5404.2 G1205404



LEXUS, MITSUBISHI, TOYOTA

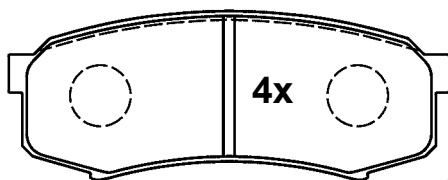

23947 15,4

116,2 x 44,0 x 15,4

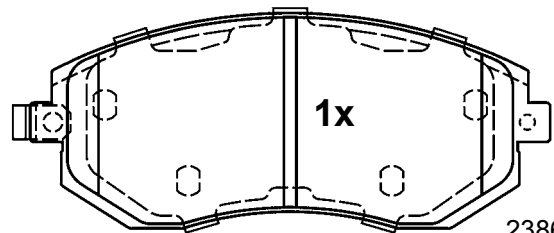

23867 17,6

137,0 x 56,8 x 17,6

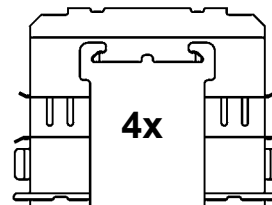

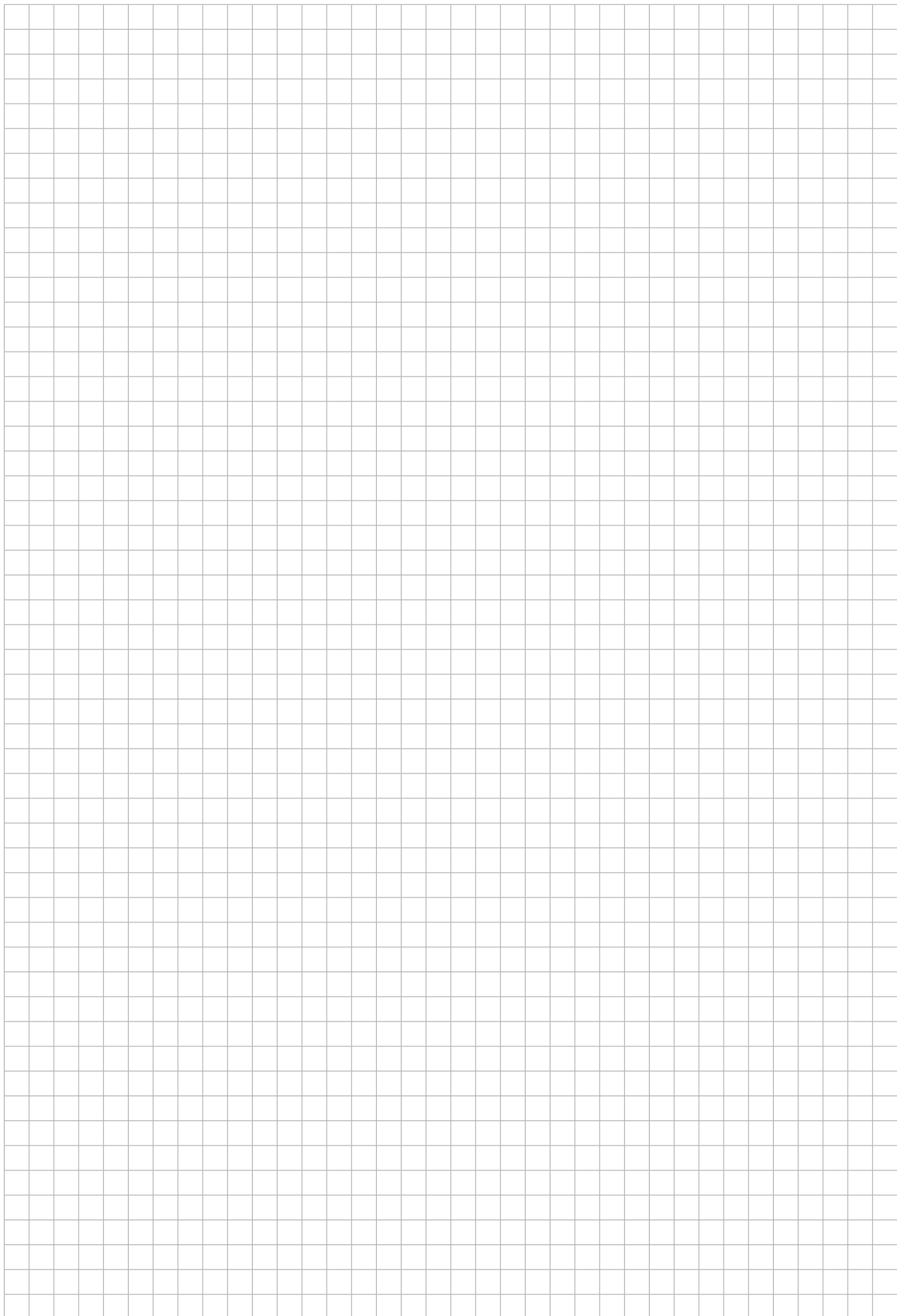



# DIMENSIONS BRAKE DISCS

Dimensions disques de frein / Misure dischi freno

Dimensões dos discos dos travões / Wymiary tarcz hamulcowych

Rozměry brzdových kotoučů

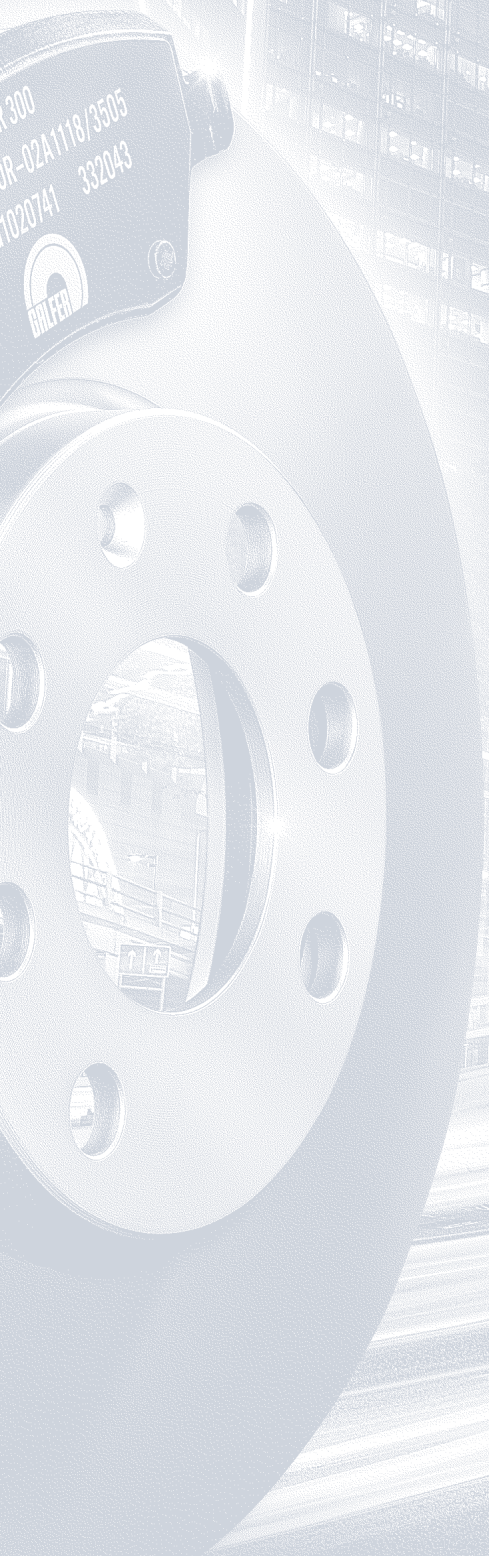

# Dimensions brake discs

Dimensions disques de frein / Misure dischi freno /  
Dimensões dos discos dos travões / Wymiary tarcz hamulcowych /  
Rozměry brzdových kotoučů

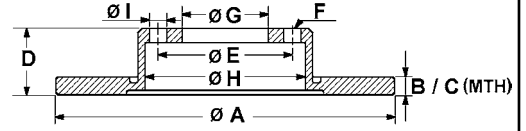

S fixing screw / vis de fixation / vite di riparazione / parafuso de fixaçào / šruba mocijuća / Upevňovací šroub  
B coated / revêtu / rivestito / revestido / pokryty / povlečený  
HC high carbon / à haute teneur en carbone / alto teor de carbono / wysokiej węglą / s vysokým obsahem uhlíku

L alloyed / allié / lega / com liga / stopowe / legovaná  
V ventilated / ventilé / ventilato / arejado / wentylowanym / větrané

● perforated / perforé / perforata / perforado / perforovaný / perforovaný

	S	B	HC	L	V	A	B	C	D	E	F	G	H	I	OE - #	
B1.G207-0109.1 G2107109	S	B				240,0	7,0	6,0	41,0	100,0	4	61,0	140,0	12,6	NISSAN	43206-5F001
B1.G208-0104.1 G2108104	S	B				238,0	8,2	7,0	41,0	100,0	4	61,0	129,5	12,4	RENAULT	77 01 204 285
B1.G208-0106.1 G2108106	S	B				247,0	8,0	6,0	25,3	108,0	4	71,1	133,5	13,0	CITROEN	4249 F5
															PEUGEOT	4249 F5
B1.G208-0107.1 G2108107	S	B				238,0	8,0	6,0	29,0	98,0	3	57,0	124,5	13,0	CITROEN	95 027 199 95 661 810
															PEUGEOT	4246 G0
B1.G208-0108.1 G2108108	B					238,0	8,0	7,0	74,6	100,0	4	52,0	52,3	M12x1,5	RENAULT	77 00 780 077 77 00 780 078 77 00 829 553 77 01 204 293 77 01 204 294 77 01 204 523 77 01 204 901
B1.G208-0109.1 G2108109	B					238,0	8,0	7,0	74,6	100,0	4	52,0	52,3	M12x1,5	RENAULT	77 00 805 006 77 00 805 148 77 01 204 302 77 01 204 303
B1.G208-0113.1 G2108113	S	B				258,0	8,0	7,0	57,3	112,0	5	67,0	164,0	15,0	MERCEDES BENZ	169 423 09 12
B1.G209-0114.1 G2109114	S	B				278,0	9,0	7,3	55,5	112,0	5	67,0	164,0	13,2	CHRYSLER	5098 066AA
															MERCEDES BENZ	203 423 01 12 210 423 01 12 210 423 04 12 210 423 09 12
B1.G209-0120.1 G2109120	S	B				258,0	9,0	7,3	55,5	112,0	5	67,0	164,0	12,8	MERCEDES BENZ	202 423 00 12
B1.G209-0123.1 G2109123	S	B				230,0	9,0	7,0	40,6	100,0	5	65,0	125,8	15,6	AUDI/SEAT/SKODA/VW	1J0 615 601 C 1J0 615 601 P 6N0 615 601 A 6N0 615 601 B
B1.G209-0124.1 G2109124	B					232,0	9,0	7,0	39,5	100,0	4	65,0	125,0	13,6	SEAT/VW	6N0 615 601 A 6N0 615 601 B
B1.G209-0133.1 G2109133	S	B				239,0	8,9	7,0	33,4	100,0	5	65,0	132,5	15,8	AUDI/VW/SKODA	1J0 615 601 D
B1.G209-0136.1 G2109136	B	HC				280,0	9,0	8,0	38,0	112,0	3	58,0	153,5	12,5	SMART	000 4341 V002 000000
B1.G209-0137.1 G2109137	S	B				247,0	9,0	8,0	35,0	108,0	4	71,1	133,0	13,0	CITROEN	4246 X8 4259 53 4249 90
															PEUGEOT	4246 W9 4259 52 4249 90
B1.G209-0139.1 G2109139	B					269,0	9,0	8,0	56,0	100,0	4	55,0	173,0	14,5	TOYOTA	42431-12250 42431-52050 42431-47020
B1.G209-0142.1 G2109142	B					278,0	9,0	7,0	24,7	100,0	4	55,0	147,0	14,3	DAIHATSU TOYOTA	42431-0D060 42431-0D060
B1.G209-0157.1 G2109157	B					291,5	9,0	8,0	62,0	114,3	5	68,0	172,0	12,7	NISSAN	43206-JD00A
B1.G210-0111.1 G2110111	B					226,0	10,0	8,0	71,2	100,0	4	39,8	121,4	M12x1,5	SEAT/VW VOLKSWAGEN	357 615 601 6N0 615 601
B1.G210-0115.1 G2110115	B					253,0	10,2	8,9	33,0	108,0	4	63,5	155,0	13,7	FORD	1514237 4083484 5022666 5030658
B1.G210-0151.1 G2110151	S	B				239,0	10,0	8,0	38,9	100,0	4	65,0	124,5	13,6	AUDI/SEAT/VW	811 615 301
B1.G210-0178.1 G2110178	B					245,0	10,0	8,0	59,5	108,0	4	68,0	135,8	15,4	AUDI	443 615 601
B1.G210-0187.1 G2110187	S	B				247,0	10,0	9,0	34,2	108,0	4	66,0	133,0	13,0	CITROEN PEUGEOT	95 661 748 4246 A5 4249 95
B1.G210-0190.1 G2110190	B					251,5	10,0	9,0	50,7	98,0	4	59,0	127,5	13,0	ALFA/FIAT/LANCIA	46758715 46831042 82434070 71738913
B1.G210-0196.1 G2110196	B					239,7	10,0	8,0	43,0	108,0	4	63,6	136,0	13,8	FIAT FORD	5022652 5022653
B1.G210-0201.1 G2110201	B					245,0	10,0	8,0	64,2	112,0	5	68,0	135,5	15,4	AUDI/SKODAVW	4A0 615 601 A
B1.G210-0202.1 G2110202	S	B	HC			280,0	10,0	8,4	60,0	120,0	5	75,0	160,8	14,5	BMW	34 21 1 165 457
B1.G210-0209.1 G2110209	B					251,4	10,0	9,0	50,5	98,0	5	59,0	127,5	13,0	ALFA/FIAT/LANCIA	7789267 60569164 60653479 60658566 60801787 82439939 82440275
B1.G210-0210.1 G2110210	B					245,0	10,0	8,0	83,6	112,0	5	45,2	135,5	M14x1,5	AUDI	8D0 615 601 B
B1.G210-0211.1 G2110211	S	B	HC			272,0	10,0	8,4	78,0	120,0	5	75,0	160,8	14,5	BMW	34 21 6 758 552



# Dimensions brake discs

Dimensions disques de frein / Misura dischi freno /  
Dimensões dos discos dos travões / Wymiary tarcz hamulcowych /  
Rozměry brzdových kotoučů

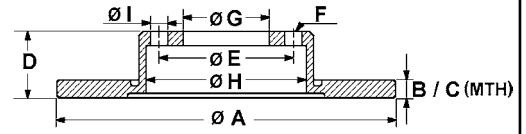

S fixing screw / vis de fixation / vite di riparazione / parafuso de fixaçã / šruba mocijuća / Upevňovací šroub  
B coated / revêtu / rivestito / revestido / pokryty / povlečený  
HC high carbon / à haute teneur en carbone / alto teor de carbono / wysokię węgla /  
s vysokým obsahem uhlíku

L alloyed / allié / lega / com liga / stopowe / legovaná  
V ventilated / ventilé / ventilato / arejado / wentylowanym / větrané

● perforated / perforé / perforata / perforado / perforowany / perforovaný

		S	B	HC	L	V	A	B	C	D	E	F	G	H	I	OE - #
B1.G210-0212.1	G2110212	S	B				238,5	10,0	8,0	48,1	100,0	4	61,0	154,5	13,0	HONDA ROVER 42510-SE0-010 42510-SH3-G00 42510-SK3-305 42510-SK3-E00 GBD90817 EGP1254
B1.G210-0213.1	G2110213		B				270,0	10,0	8,6	62,6	108,0	4	63,5	180,0	13,7	FORD 5025951
B1.G210-0215.1	G2110215		B				258,0	10,0	9,0	45,0	114,3	4	68,0	154,0	12,6	NISSAN 43206-99J01
B1.G210-0217.1	G2110217	S	B				290,0	10,0	8,3	55,5	112,0	5	67,0	164,0	13,3	MERCEDES BENZ 210 423 06 12 210 423 10 12
B1.G210-0223.1	G2110223	S	B				268,0	10,0	8,0	45,8	112,0	5	68,2	154,5	16,8	FORD 1001094 1045995
B1.G210-0225.1	G2110225	S	B				270,0	10,0	8,0	69,3	100,0	4	57,0	160,0	14,0	SEAT/VW 7M0 615 601 C
B1.G210-0229.1	G2110229		B				260,0	10,0	8,4	41,0	114,3	4	90,0	154,0	12,6	OPEL/VAUXHALL 5 69 209/90512909 MITSUBISHI MB699288 MR249356 MR913846 30872940
B1.G210-0230.1	G2110230		B				290,5	10,0	8,0	60,0	108,0	4	71,0	185,0	13,0	VOLVO PEUGEOT 4246 L7 4246 T6 4246 T7
B1.G210-0232.1	G2110232	S	B				239,0	9,9	8,0	33,6	100,0	4	65,0	125,0	13,8	SEAT/VW 6N0 615 301
B1.G210-0250.1	G2110250	S	B				264,0	9,8	8,0	42,0	110,0	5	65,5	145,0	14,0	OPEL/VAUXHALL 5 69 109/9117772
B1.G210-0251.1	G2110251	S	B				240,0	9,8	8,0	42,0	100,0	4	57,0	140,8	14,0	OPEL/VAUXHALL 5 69 111/9196587
B1.G210-0258.1	G2110258		B				245,0	10,0	8,0	54,1	112,0	5	68,0	135,5	15,3	AUDI 4B0 615 601
B1.G210-0261.1	G2110261		B				245,0	10,0	8,0	40,0	112,0	5/9	68,0	135,5	15,3	AUDI 8E0 615 601 B 8E0 615 601 P
B1.G210-0271.1	G2110271		B				259,0	10,0	8,4	44,1	100,0	4	64,2	163,0	16,0	MINI 34 21 1 503 070 34 21 6 774 987
B1.G210-0277.1	G2110277	S	B				253,0	10,0	8,0	51,6	112,0	5/9	65,0	140,0	15,3	AUDI/SEAT/SKODA/VW 1K0 615 601 K 1K0 615 601 AB
B1.G210-0278.1	G2110278	S	B				300,0	10,0	8,3	68,3	112,0	5	67,0	180,0	15,3	MERCEDES BENZ 000 423 10 12 211 423 07 12
B1.G210-0285.1	G2110285		B				278,0	10,0	9,0	45,0	114,3	5	68,0	154,0	12,5	NISSAN 43206-4U101 43206-4U103
B1.G210-0302.1	G2110302		B				280,0	10,0	8,0	40,2	114,3	5	72,0	142,0	13,0	MAZDA GF3Y-26-251A GFYY-26-251 N123-26-251 NF47-26-251
B1.G210-0312.1	G2110312		B				262,0	10,0	8,4	64,0	100,0	4	62,5	168,0	12,6	HYUNDAI/KIA 58411-1C800
B1.G210-0324.1	G2110324		B				234,0	10,0	8,0	37,5	100,0	4	62,5	142,0	12,6	HYUNDAI KIA 58411-0X500 58411-07300 58411-07500
B1.G210-0356.1	G2110356	S	B				272,0	9,7	8,0	48,2	112,0	9	65,0	174,5	15,3	AUDI/SEAT/SKODA/VW 1K0 615 601 AA
B1.G211-0145.1	G2111145		B				302,0	10,9	9,0	50,8	108,0	5	63,5	177,6	15,8	FORD 1379931 1385590 1405500 LR027123
B1.G211-0152.1	G2111152		B				240,0	11,0	8,0	41,0	100,0	4/6	60,0	126,0	14,5	LAND ROVER OPEL/VAUXHALL 5 69 020/9195981
B1.G211-0154.1	G2111154		B				278,0	11,0	9,0	53,7	108,0	5	63,5	146,0	13,7	FORD 4367107 4457989 4475316
B1.G211-0155.1	G2111155		B				265,0	11,0	9,0	40,8	108,0	5	63,5	152,0	13,7	FORD 1223540 1253728 1373360 1575733 1748745 9M51-2A315-BA 9M51-2A315-BB
B1.G211-0158.1	G2111158	S	B				280,0	11,0	9,0	41,0	108,0	5	63,5	192,0	13,7	FORD 1253962 1373361 1500156 7M51-2A315-BA 30769113
B1.G211-0164.1	G2111164		B				265,0	11,0	9,0	40,7	114,3	5	72,0	152,0	14,0	MAZDA 31341645 BP4Y-26-251C C24Y-26-251C
B1.G212-0106.1	G2112106	S	B				239,0	12,0	10,0	35,4	100,0	4	65,0	124,5	13,6	AUDI/SEAT/VW AUDI/VW 175 615 301
B1.G212-0116.1	G2112116	S	B				238,0	12,0	10,5	41,0	100,0	4	61,0	129,5	13,5	DACIA 60 01 549 211 60 01 549 211 77 01 204 282
B1.G212-0126.1	G2112126	S	B				286,0	12,0	10,4	51,5	120,0	5	79,0	148,0	14,5	BMW 34 11 6 757 750

# Dimensions brake discs

Dimensions disques de frein / Misure dischi freno /

Dimensões dos discos dos travões / Wymiary tarcz hamulcowych /

Rozměry brzdových kotoučů

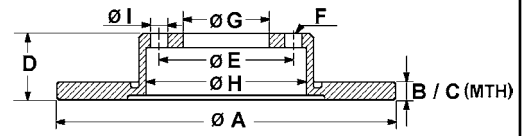

S fixing screw / vis de fixation / vite di riparazione / parafuso de fixaçào / šruba mocijuća / Upevňovací šroub

B coated / revêtu / rivestito / revestido / pokryty / povlečený

HC high carbon / à haute teneur en carbone / alto tenore di carbonio / alto teor de carbono / wysokiej węgl /

s vysokým obsahem uhlíku

L alloyed / allié / lega / com liga / stopowe / legovaná

V ventilated / ventilé / ventilato / arejado / wentylowanym / větrané

● perforated / perforé / perforata / perforado / perforowany / perforovaný

		S	B	HC	L	V	A	B	C	D	E	F	G	H	I	OE - #
B1.G212-0127.1	G2112127		B				257,5	12,0	10,2	40,5	98,0	4	59,0	123,0	13,0	ALFA/FIAT/LANCIA 7663466 46820655 51859075 51866265 60808872 51866264
B1.G212-0131.1	G2112131		B				286,0	12,0	10,0	69,5	110,0	5	65,5	160,0	14,0	FIAT OPEL/VAUXHALL 5 69 208/90444513
B1.G212-0137.1	G2112137		B				234,0	12,0	10,0	45,2	100,0	4	59,0	129,5	12,5	NISSAN 40206-5F003
B1.G212-0138.1	G2112138		S	B			280,0	12,0	10,0	40,4	112,0	5	68,2	153,0	16,5	VOLKSWAGEN 701 615 601 A 7D0 615 601 7D0 615 601 B
B1.G212-0141.1	G2112141		B				239,5	12,0	10,0	42,9	108,0	4	63,5	136,0	13,7	FORD 1013581 1019598 1112542 MAZDA 1E03-33-251 1E03-33-251A 1E04-33-251
B1.G212-0144.1	G2112144		S	B	HC	L	260,0	12,0	10,0	40,4	112,0	5	67,0	145,0	13,3	MERCEDES BENZ 168 421 01 12
B1.G212-0154.1	G2112154		B				280,0	12,0	10,0	34,0	108,0	5	63,5	151,0	13,7	FORD 1376138 4176921 4179406 JAGUAR C2S 35271 C2S 42668 C2S 49730
B1.G212-0155.1	G2112155		S	B			305,0	12,0	10,5	66,8	130,0	5	90,0	169,5	15,5	NISSAN 43206-00QAA OPEL/VAUXHALL 44 03 045/9111045
B1.G212-0157.1	G2112157		S	B			278,0	11,9	10,0	41,4	110,0	5	65,5	145,2	14,0	RENAULT 77 00 314 107 FIAT 46836489 OPEL/VAUXHALL 5 69 115/93171848 SAAB 9156785 12762290
B1.G212-0158.1	G2112158		B				256,0	12,0	10,0	48,6	112,0	5/9	65,0	140,0	15,3	AUDI/SKODA/VW 1K0 615 601 L 1K0 615 601 AC
B1.G212-0162.1	G2112162		S	B			290,0	12,0	10,0	35,0	108,0	5	71,1	151,2	13,0	CITROEN 4249 72 4249 C1 PEUGEOT 4246 P9 4249 C1
B1.G212-0169.1	G2112169		S	B			282,0	12,0	10,0	48,6	112,0	5/9	65,0	159,0	15,3	AUDI/SKODA/VW 1K0 615 601 M 1K0 615 601 AD
B1.G212-0171.1	G2112171		S	B			259,0	12,0	10,6	40,9	100,0	4	61,0	130,0	13,5	DACIA 60 01 547 683 77 01 208 252 RENAULT 60 01 547 683 77 01 208 252
B1.G212-0178.1	G2112178		S	B			300,0	12,0	10,0	36,4	112,0	5	68,0	169,0	15,3	AUDI 8K0 615 601 B
B1.G212-0184.1	G2112184		S	B			257,0	12,0	10,0	40,5	100,0	4/6	60,0	127,0	14,3	FIAT 51806099 51806103 55700398 55700918 OPEL/VAUXHALL 5 69 022/93188916 OPEL/VAUXHALL 5 69 020/90008005 5 69 030/90008031 5 69 013/93182290
B1.G213-0161.1	G2113161		S	B			236,0	12,7	9,7	41,0	100,0	4/6	60,0	123,0	14,0	SEAT/VW 357 615 301 AUDI 8D0 615 301 A
B1.G213-0178.1	G2113178		S	B	HC		255,6	12,9	11,0	39,2	100,0	4	65,0	135,5	13,6	SKODA/VW 6U0 615 301
B1.G213-0181.1	G2113181		B				280,0	13,0	11,0	46,5	112,0	5	68,0	159,0	15,4	CITROEN 4249 R4 4249 82 4246 R2
B1.G213-0182.1	G2113182		B				236,0	12,8	11,4	45,7	100,0	4	62,0	125,5	14,8	PEUGEOT 4246 R9 4246 R8 4249 A5
B1.G213-0184.1	G2113184		S	B			266,0	13,0	11,0	27,2	108,0	4	66,0	133,0	13,0	CHEVROLET 96284392 96455424 96284392
B1.G213-0185.1	G2113185		S	B			247,5	13,0	11,0	34,2	108,0	4	66,0	133,0	13,0	DAEWOO 4A0 615 301 B
B1.G213-0195.1	G2113195		B				236,0	12,6	9,7	35,4	102,0	4	86,0	107,5	M10x1,25	CITROEN 4249 42 4249 K6 FIAT 51740250 51749555 PEUGEOT 4249 41 4249 K6
B1.G215-0105.1	G2115105		B	HC			288,0	15,0	13,0	46,5	112,0	5	68,0	135,5	15,4	
B1.G216-0123.1	G2116123		B				300,0	16,0	14,2	80,0	130,0	5	79,0	172,0	17,5	

# Dimensions brake discs

Dimensions disques de frein / Misura dischi freno /  
Dimensões dos discos dos travões / Wymiary tarcz hamulcowych /  
Rozměry brzdových kotoučů

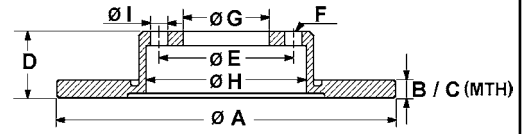

S fixing screw / vis de fixation / vite di riparazione / parafuso de fixação / šruba mocijuća / Upevňovací šroub  
B coated / revêtu / rivestito / revestido / pokryty / povlečený  
HC high carbon / à haute teneur en carbone / alto tenore di carbonio / alto teor de carbono / wysokię węgla /  
s vysokým obsahem uhlíku  
L alloyed / allié / lega / com liga / stopowe / legovaná  
V ventilated / ventilé / ventilato / arejado / wentylowanym / větrané  
● perforated / perforé / perforata / perfurado / perforovaný / perforovaný

		S	B	HC	L	V	A	B	C	D	E	F	G	H	I	OE - #	
<b>B1.G216-0124.1 G2116124</b>			B				280,0	16,0	14,2	82,0	118,0	5	72,0	172,0	15,6	CITROEN FIAT PEUGEOT	4246 Y7 4249 K7 46833806 51740245 51749274 51848617 4246 Y9 4249 K7
<b>B1.G218-0106.1 G2118106</b>		S	B	HC		V	239,0	18,0	16,0	34,5	100,0	4	65,0	125,0	13,6	SEAT/VW VOLKSWAGEN TOYOTA	6N0 615 301 C 6N0 615 301 F 43512-0D010 43512-52050
<b>B1.G218-0131.1 G2118131</b>			B			V	235,0	17,9	16,0	43,2	100,0	4	55,0	129,5	14,5	SKODA/VW VOLKSWAGEN	6Q0 615 301 6Q0 615 301 A
<b>B1.G218-0137.1 G2118137</b>		S	B	HC		V	239,0	18,0	16,0	35,0	100,0	5	65,0	125,0	15,6	HYUNDAI KIA	51712-0X500 51712-07500
<b>B1.G218-0145.1 G2118145</b>			B			V	241,0	18,0	16,0	49,0	100,0	4	62,2	126,0	12,6	BMW BMW	34 21 6 855 155 34 21 1 165 563
<b>B1.G219-0107.1 G2119107</b>		S	B	HC		V	276,0	19,0	17,4	60,3	120,0	5	75,0	160,8	14,5	CHEVROLET DAEWOO	90121445 90121445
<b>B1.G219-0108.1 G2119108</b>		S	B	HC		V	294,0	18,9	17,4	59,7	120,0	5	75,0	160,8	14,8	OPEL/VAUXHALL AUDI/SEAT/VW	5 69 054/90511111 321 615 301 C
<b>B1.G220-0115.1 G2120115</b>		S	B	HC	L	V	236,0	20,0	17,0	41,0	100,0	4/6	60,0	123,0	14,0	NISSAN SEAT/VW	40206-00QAJ 321 615 301 D 6N0 615 301 D
<b>B1.G220-0123.1 G2120123</b>		S	B	HC	L	V	239,0	20,0	18,0	39,0	100,0	4	65,0	123,8	13,6	CITROEN PEUGEOT	95 661 747 4246 A7 4249 96
<b>B1.G220-0125.1 G2120125</b>		S	B			V	238,0	20,1	17,7	41,0	100,0	4	61,0	128,0	12,5	CITROEN PEUGEOT	4249 F0 4246 97 4249 F0
<b>B1.G220-0128.1 G2120128</b>		S	B	HC	L	V	256,0	20,0	18,0	38,8	100,0	4	65,0	131,5	13,8	OPEL/VAUXHALL ALFA/FIAT/LANCIA	5 69 055/90511128 7779409 71738145 51749124 60806137 60810076 60811256 60811266
<b>B1.G220-0132.1 G2120132</b>		S	B			V	247,0	20,4	18,5	34,2	108,0	4	66,0	133,2	12,8	FORD	4115996 5026786
<b>B1.G220-0133.1 G2120133</b>		S	B			V	266,0	20,5	18,5	27,6	108,0	4	66,0	133,0	13,0	FORD/MAZDA	1019604 1066271 1320581 1320582 5028281
<b>B1.G220-0146.1 G2120146</b>			B			V	253,0	20,0	18,0	43,7	108,0	4	63,5	153,0	13,7	CITROEN FIAT PEUGEOT	4249 L4 1316323080 4246 H8
<b>B1.G220-0147.1 G2120147</b>			B			V	239,5	20,0	18,0	43,0	108,0	4	63,5	136,0	13,7	OPEL/VAUXHALL TOYOTA	5 69 021/9195985 43512-0D050 43512-17120 43512-17130 43512-17131 43512-52040 43512-52090
<b>B1.G220-0155.1 G2120155</b>			B	HC	L	V	257,5	20,0	18,2	40,5	98,0	5	59,0	126,7	16,5	CITROEN FIAT PEUGEOT	4249 L4 1316323080 4246 H8
<b>B1.G220-0174.1 G2120174</b>			B			V	240,0	20,0	17,0	41,0	100,0	4/6	60,0	126,0	14,0	OPEL/VAUXHALL TOYOTA	5 69 021/9195985 43512-0D050 43512-17120 43512-17130 43512-17131 43512-52040 43512-52090
<b>B1.G220-0175.1 G2120175</b>			B			V	255,0	20,0	18,0	43,1	100,0	4	55,0	129,0	14,5	CITROEN PEUGEOT TOYOTA	4246 J0 4259 55 4249 94 4246 F0 4249 54 4249 94 43512-0H010 43512-0H020
<b>B1.G220-0180.1 G2120180</b>		S	B			V	247,0	20,0	18,0	35,3	100,0	4	55,0	129,0	13,2	FIAT FORD	46788929 51742727 1541806 9S51 1125-DA
<b>B1.G220-0184.1 G2120184</b>			B			V	240,5	20,0	18,2	40,5	98,0	4	59,0	146,5	13,0	BMW BMW	34 21 6 855 007 34 21 6 764 653 34 21 6 855 008
<b>B1.G220-0195.1 G2120195</b>		S	B	HC		V	300,0	20,0	18,4	66,0	120,0	5	75,0	160,8	14,5	OPEL/VAUXHALL SUZUKI	47 08 241/93192978 55311-62J00
<b>B1.G220-0204.1 G2120204</b>		S	B	HC		V	300,0	20,0	18,4	66,1	120,0	5	75,0	185,0	14,5		
<b>B1.G220-0211.1 G2120211</b>		S	B			V	252,0	20,0	18,0	40,0	100,0	4	60,0	127,0	12,5		

# Dimensions brake discs

Dimensions disques de frein / Misure dischi freno /  
Dimensões dos discos dos travões / Wymiary tarcz hamulcowych /  
Rozměry brzdových kotoučů

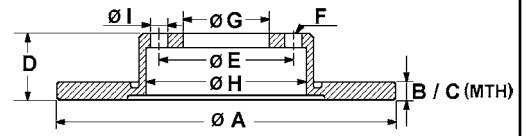

S fixing screw / vis de fixation / vite di riparazione / parafuso de fixaçào / šruba mocijuća / Upevňovací šroub  
B coated / revêtu / rivestito / revestido / pokryty / povlečený  
HC high carbon / à haute teneur en carbone / alto tenore di carbonio / wysokiej węglą /  
s vysokým obsahem uhlíku

L alloyed / allié / lega / com liga / stopowe / legovaná  
V ventilated / ventilé / ventilato / arejado / wentylowanym / větrané

● perforated / perforé / perforata / perforado / perforowany / perforovaný

		S	B	HC	L	V	A	B	C	D	E	F	G	H	I	OE - #
B1.G221-0105.1	G2121105	S	B			V	262,0	21,0	19,0	44,7	100,0	4	64,1	141,0	13,0	HONDA 45251-S5D-A10 45251-S6D-E10 45251-SCC-900 45251-SK7-A00 45251-SK7-A10 45251-SR0-A00 45251-SR0-A10 45251-ST3-E10 45251-TG5-H00 45251-TF3-E00 ROVER GBD90840 SDB000990
B1.G221-0106.1	G2121106	S	B			V	259,0	20,7	17,7	41,0	100,0	4	61,0	130,0	12,7	NISSAN DACIA/RENAULT 40206-00QAA 60 01 548 578 77 00 842 131 77 01 204 828 77 01 206 339 77 11 130 038
B1.G222-0115.1	G2122115	S	B	HC		V	286,0	22,0	20,4	51,5	120,0	5	79,0	147,5	14,5	BMW 34 11 1 165 455 34 11 6 766 239
B1.G222-0145.1	G2122145		B			V	284,0	22,0	20,2	43,5	98,0	5	59,0	127,0	13,0	ALFA/FIAT/LANCIA 46445006 60569163 60571548 60622077 60653478 60658565 60699518 OPEL/VAUXHALL 5 69 086/95511282
B1.G222-0147.1	G2122147		B			V	284,0	22,0	20,2	43,5	98,0	4	59,0	127,0	13,0	ALFA/FIAT/LANCIA 46403959
B1.G222-0148.1	G2122148	S	B	HC	L	V	262,0	22,0	19,8	44,0	100,0	4	61,0	132,0	13,5	RENAULT 77 01 205 840
B1.G222-0150.1	G2122150	S	B	HC		V	280,0	22,0	19,0	36,7	100,0	5	65,0	133,5	15,6	AUDI/SEAT/SKODA/VW 1J0 615 301 E 1J0 615 301 M 1J0 615 301 P
B1.G222-0151.1	G2122151	S	B	HC		V	256,0	22,0	19,0	36,7	100,0	5	65,0	133,5	15,6	AUDI/SEAT/SKODA/VW 1J0 615 301 D 1J0 615 301 L 6R0 615 301 8Z0 615 301 D
B1.G222-0152.1	G2122152		B	HC		V	280,0	22,0	20,0	46,3	112,0	5/9	68,0	146,5	15,3	AUDI/VW 8E0 615 301 B 8E0 615 301 D 8E0 615 301 P
B1.G222-0159.1	G2122159	S	B	HC		V	296,0	22,0	20,4	76,3	120,0	5	79,0	148,8	14,5	BMW 34 11 6 767 061
B1.G222-0160.1	G2122160	S	B	HC		V	300,0	22,0	20,4	51,8	120,0	5	79,0	164,0	14,5	BMW 34 11 1 164 539 34 11 6 757 526 34 11 6 766 224 34 11 6 855 152
B1.G222-0161.1	G2122161	S	B	HC	L	V	276,0	22,0	19,0	77,2	130,0	5	85,0	156,3	15,0	MERCEDES BENZ 902 421 06 12 902 421 07 12 902 421 09 12 VOLKSWAGEN 2D0 615 301 C 2D0 615 301 D
B1.G222-0163.1	G2122163		B	HC		V	256,0	22,0	20,0	36,6	100,0	5	65,0	135,0	15,6	AUDI/VW 8N0 615 601 B
B1.G222-0172.1	G2122172		B			V	258,0	22,0	20,0	43,4	108,0	4	63,5	136,0	13,7	FORD 1320585 1323620 MAZDA DD32-33-25X DD59-33-25X DD63-33-25XA
B1.G222-0194.1	G2122194	S	B			V	266,0	22,0	20,0	34,2	108,0	4	66,0	133,1	13,0	CITROEN 4246 W1 4249 83 4249 G1 PEUGEOT 4246 W7 4249 83 4249 G1
B1.G222-0197.1	G2122197		B			V	257,5	22,0	20,2	40,5	98,0	4	59,0	127,0	13,0	CITROEN 4249 74 4249 L2 FIAT/LANCIA 46401356 46542383 46831041 51896287 51896288 PEUGEOT 4249 73 4249 L2
B1.G222-0204.1	G2122204		B	HC		V	276,0	22,0	20,4	44,2	100,0	4	64,2	150,0	14,7	MINI 34 11 1 502 891
B1.G222-0210.1	G2122210	S	B	HC		V	280,0	22,0	19,0	49,9	112,0	5/9	65,0	144,0	15,3	AUDI/SEAT/SKODA/VW VOLKSWAGEN 1K0 615 301 AK 5C0 615 301

# Dimensions brake discs

Dimensions disques de frein / Misura dischi freno /  
Dimensões dos discos dos travões / Wymiary tarcz hamulcowych /  
Rozměry brzdových kotoučů

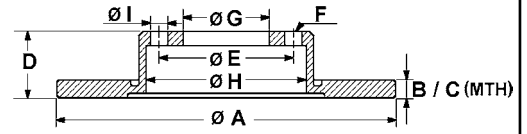

S fixing screw / vis de fixation / vite di riparazione / parafuso de fixaçã / šruba mocijuća / Upevňovací šroub  
B coated / revêtu / rivestito / revestido / pokryty / povlečený  
HC high carbon / à haute teneur en carbone / alto teor de carbono / wyskiej węgl / s vysokým obsahem uhlíku  
L alloyed / allié / lega / com liga / stopowe / legovaná  
V ventilated / ventilé / ventilato / arejado / wentylowanym / větrané  
● perforated / perforé / perforata / perforado / perforovaný / perforovaný

		S	B	HC	L	V	A	B	C	D	E	F	G	H	I	OE - #	
B1.G222-0211.1	G2122211	S	B	HC		V	294,0	21,9	19,5	44,4	120,0	5	76,0	154,6	16,6	VOLKSWAGEN	7H0 615 601 B
B1.G222-0216.1	G2122216	S	B	HC		V	260,0	22,0	19,8	44,0	100,0	4	61,0	125,0	13,6	NISSAN	40206-AX600 40206-AX603
																RENAULT	77 01 207 795
B1.G222-0231.1	G2122231	S	B			V	257,0	22,0	20,0	40,5	100,0	4/6	60,0	126,0	14,5	FIAT	55700920 55700921
																OPEL/VAUXHALL	5 69 024/93188917 5 69 065/9319724
B1.G222-0232.1	G2122232	S	B	HC	L	V	276,0	22,0	19,4	44,5	112,0	5	67,0	145,0	15,3	MERCEDES BENZ	169 421 08 12
B1.G222-0238.1	G2122238	S	B	HC		V	292,0	22,0	20,4	73,3	120,0	5	79,0	151,5	14,5	BMW	34 11 6 854 997
B1.G222-0240.1	G2122240		B			V	258,0	22,0	20,0	46,0	100,0	4	55,0	131,0	14,3	DAIHATSU	43512-0D060
																TOYOTA	43512-0D060
B1.G222-0258.1	G2122258		B			V	255,0	22,0	20,0	49,3	100,0	5	55,0	131,0	14,5	TOYOTA	43512-47030
B1.G222-0270.1	G2122270	S	B			V	258,0	22,0	19,8	44,0	100,0	4	61,0	125,3	13,5	MERCEDES BENZ	415 420 01 01 40 20 612 00R
																DACIA	77 01 210 081
																RENAULT	40 20 612 00R
B1.G223-0113.1	G2123113		B			V	258,0	23,0	21,0	43,8	108,0	4	63,5	136,0	13,0	FORD	1523795 1535924 1546835 1679853 8V51-1125-AC 8V51-1125-AD
B1.G224-0115.1	G2124115	S	B	HC	L	V	256,0	24,0	21,0	41,0	100,0	4/6	60,0	123,0	14,0	DAEWOO	96179110
																OPEL/VAUXHALL	5 69 001/90487402
B1.G224-0120.1	G2124120		B			V	260,0	24,0	22,2	47,0	108,0	4	63,5	136,0	13,6	FORD	4070865 5026784
B1.G224-0127.1	G2124127		B			V	280,0	24,0	21,9	67,6	118,0	5	73,0	142,0	15,5	CITROEN	4246 Y1 4249 99 4249 K3
																FIAT	46806233 51728377 51740244 51848619
																PEUGEOT	4246 X9 4249 99 4249 K3
B1.G224-0131.1	G2124131		B			V	254,0	24,2	22,2	43,0	100,0	5	78,5	104,0	M10	FORD	5025610 5029815
B1.G224-0138.1	G2124138		B			V	300,0	24,0	21,9	65,5	130,0	5	80,0	161,0	17,5	CITROEN	4246 Y3 4249 36 4249 H2
																FIAT	46806234 51728378 51740247 51858363
																PEUGEOT	4246 Y5 4249 35 4249 H2
B1.G224-0152.1	G2124152	S	B	HC	L	V	256,0	23,8	21,0	41,1	100,0	4	60,0	123,0	14,3	OPEL/VAUXHALL	5 69 059/9117677
B1.G224-0158.1	G2124158	S	B	HC	L	V	280,0	24,0	21,8	44,0	100,0	4	61,0	140,0	13,6	RENAULT	77 01 207 829
B1.G224-0161.1	G2124161		B			V	300,0	23,9	22,0	47,0	108,0	5	63,5	155,0	13,7	FORD	1376118 4179398 4181042
																JAGUAR	C2S 35270 C2S 42667
B1.G224-0166.1	G2124166		B	HC	L	V	260,0	24,0	21,0	41,0	100,0	4/6	60,0	126,0	14,5	OPEL/VAUXHALL	5 69 000/9196050
B1.G224-0169.1	G2124169		B	HC		V	280,0	24,0	21,8	46,9	108,0	5	61,0	139,8	13,5	RENAULT	82 00 007 121
B1.G224-0171.1	G2124171	S	B	HC	L	V	280,0	24,0	21,8	44,0	108,0	5	61,0	140,0	15,5	RENAULT	77 01 206 198
B1.G224-0191.1	G2124191	S	B	HC		V	300,0	24,0	21,8	43,9	100,0	4	61,0	139,8	13,5	RENAULT	77 01 207 897
B1.G224-0197.1	G2124197	S	B	HC		V	300,0	24,0	22,4	73,5	120,0	5	79,0	152,0	14,5	BMW	34 11 6 764 643 34 11 6 854 998
																RENAULT	40 20 600 10R
B1.G224-0222.1	G2124222	S	B	HC		V	280,0	24,0	21,8	44,0	108,0	5	61,0	140,0	15,8	MERCEDES BENZ	415 420 00 01 415 421 04 12
																RENAULT	77 01 209 839
B1.G225-0105.1	G2125105		B	HC		V	288,0	25,0	23,0	46,5	112,0	5/9	68,0	135,0	15,4	AUDI/SKODA	4A0 615 301 C 8E0 615 301 Q
																AUDI	4A0 615 301 D
B1.G225-0110.1	G2125110	S	B	HC	L	V	288,0	25,0	22,4	46,5	112,0	5	67,0	154,3	13,2	CHRYSLER	5098 063AA
																MERCEDES BENZ	203 421 03 12 210 421 07 12 210 421 24 12

# Dimensions brake discs

Dimensions disques de frein / Misure dischi freno /

Dimensões dos discos dos travões / Wymiary tarcz hamulcowych /

Rozměry brzdových kotoučů

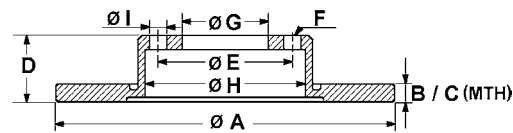

S fixing screw / vis de fixation / vite di riparazione / parafuso de fixaçào / šruba mocijujaca / Upevňovací šroub

B coated / revêtu / rivestito / revestido / pokryty / povlečený

HC high carbon / à haute teneur en carbone / alto tenore di carbonio / alto teor de carbono / wysokiej węgla /

s vysokým obsahem uhlíku

L alloyed / allié / lega / com liga / stopowe / legovaná

V ventilated / ventilé / ventilato / arejado / wentylowanym / větrané

● perforated / perforé / perforata / perforado / perforowany /

perforovaný

		S	B	HC	L	V	A	B	C	D	E	F	G	H	I	OE - #	
B1.G225-0113.1	G2125113	S	B	HC		V	288,0	25,0	22,0	34,5	100,0	5	65,0	136,0	15,6	AUDI/SEAT/SKODA/VW	1J0 615 301 R 1J0 615 301 S 6R0 615 301 A
B1.G225-0114.1	G2125114	S	B	HC		V	288,0	25,1	21,0	55,4	112,0	5	68,2	144,2	16,5	FORD SEAT/VW VOLKSWAGEN	1045994 7M0 615 301 G 8E0 615 301 A 8E0 615 301 C
B1.G225-0115.1	G2125115		B	HC		V	282,5	25,0	23,0	46,5	112,0	5	68,0	135,0	15,3	FORD	1373369 1734696 AV61-1125-BB 31262718
B1.G225-0117.1	G2125117		B	HC		V	278,0	25,0	23,0	48,5	108,0	5	63,5	140,0	13,7	FORD	1373369 1734696 AV61-1125-BB 31262718
B1.G225-0119.1	G2125119	S	B	HC	L	V	288,0	25,0	22,0	42,0	110,0	5/7	70,0	139,0	14,0	VOLVO OPEL/VAUXHALL SAAB	5 69 056/90512029 32025723 5390786
B1.G225-0123.1	G2125123		B	HC		V	310,0	25,0	22,0	34,5	100,0	5/9	65,0	185,0	15,6	AUDI/SEAT/SKODA/VW	6R0 615 301 B 8N0 615 301 A 8L0 615 301
B1.G225-0124.1	G2125124		B			V	255,0	24,9	24,0	49,2	100,0	5	55,0	156,0	14,5	AUDI/VW TOYOTA	43512-20470 43512-20580 43512-20700
B1.G225-0131.1	G2125131	S	B	HC	L	V	280,0	24,8	22,0	42,0	110,0	5/7	70,0	139,0	14,0	OPEL/VAUXHALL	5 69 066/93197592
B1.G225-0137.1	G2125137		B	HC		V	312,0	25,0	23,0	46,5	112,0	5	68,0	158,0	15,3	AUDI/SKODA	4B0 615 301 A 8E0 615 301 R
B1.G225-0138.1	G2125138	S	B	HC		V	325,0	24,9	23,4	52,6	120,0	5	79,0	174,0	14,5	BMW	34 10 1 166 071 34 11 6 855 156
B1.G225-0141.1	G2125141	S	B	HC		V	285,0	24,9	22,0	42,1	110,0	5/7	70,0	139,0	14,0	FIAT OPEL/VAUXHALL SAAB	51819733 5 69 003/93171497 9156807 93171497
B1.G225-0142.1	G2125142	S	B	HC	L	V	308,0	25,0	23,0	42,0	110,0	5/8	70,0	139,0	14,0	OPEL/VAUXHALL SAAB	5 69 061/9194477 5391560 9184405
B1.G225-0145.1	G2125145	S	B	HC		V	288,0	25,0	22,0	49,9	112,0	5/9	65,0	144,0	15,3	AUDI/SEAT/SKODA/VW VOLKSWAGEN	1K0 615 301 T 5C0 615 301 A
B1.G225-0148.1	G2125148	S	B	HC	L	V	280,0	25,0	22,0	42,0	100,0	4/6	60,0	139,0	14,5	OPEL/VAUXHALL	5 69 006/93175376
B1.G225-0149.1	G2125149		B	HC		V	314,0	25,0	23,0	59,7	112,0	5	68,0	144,0	15,3	AUDI	4F0 615 301 D
B1.G225-0155.1	G2125155		B			V	255,0	25,0	23,0	49,3	100,0	4	55,0	131,0	14,5	TOYOTA	43512-02070 43512-13030 43512-47020
B1.G225-0158.1	G2125158	S	B	HC		V	312,0	25,0	22,0	49,9	112,0	5/9	65,0	146,0	15,3	AUDI/VW/SKODA VOLKSWAGEN	1K0 615 301 AA 5C0 615 301 B
B1.G225-0162.1	G2125162		B	HC		V	300,0	25,0	23,0	48,5	108,0	5	63,5	140,0	13,7	FORD	1253965 1373370 1520297
B1.G225-0165.1	G2125165		B	HC		V	278,0	25,0	23,0	48,5	114,3	5	72,0	140,0	14,0	VOLVO	274510 31262719
B1.G225-0170.1	G2125170		B	HC		V	300,0	25,0	23,0	48,5	114,3	5	72,0	140,0	14,0	MAZDA	BP4Y-33-25XC C24Y-33-25XB C24Y-33-25XC C24Y-33-25XD
B1.G225-0171.1	G2125171		B	HC		V	288,0	25,0	23,0	46,5	112,0	5/10	68,0	137,0	15,3	MAZDA	BP6Y-33-25XE C26Y-33-25XB
B1.G225-0184.1	G2125184	S	B	HC		V	314,0	25,0	23,0	52,4	112,0	5	68,0	154,0	15,3	SKODA/VW AUDI	4B0 615 301 B 8K0 615 301
B1.G225-0198.1	G2125198	S	B	HC	L	V	280,0	25,0	22,0	43,2	100,0	4/6	60,0	139,0	14,5	OPEL/VAUXHALL	5 69 007/93181113 5 69 067/93197712
B1.G225-0199.1	G2125199		B	HC		V	278,0	25,0	23,0	48,5	108,0	5	63,5	140,0	13,7	FORD	1790221 AV61-1125-DB
B1.G226-0106.1	G2126106	S	B			V	283,0	26,0	24,2	28,2	108,0	4	66,0	133,5	13,0	CITROEN PEUGEOT	4246 L8 4246 R7
B1.G226-0120.1	G2126120	S	B			V	283,0	26,0	24,0	34,2	108,0	4	66,0	133,5	13,0	CITROEN	4246 W2 4249 18 4249 84 4249 J6 4246 W8 4249 17 4249 84 4249 J6
B1.G226-0150.1	G2126150		B	HC	L	V	280,0	26,0	24,4	47,2	114,3	5	69,0	143,5	12,5	PEUGEOT	51712-1H000 51712-1H100 51712-2K100
B1.G226-0154.1	G2126154		B			V	295,5	26,0	24,0	44,0	114,3	5	68,0	146,5	12,7	HYUNDAI/KIA NISSAN	40206-JD00A 40206-JG00A



# Dimensions brake discs

Dimensions disques de frein / Misura dischi freno /

Dimensões dos discos dos travões / Wymiary tarcz hamulcowych /

Rozměry brzdových kotoučů

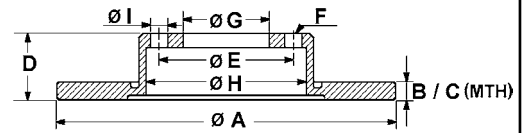

S fixing screw / vis de fixation / vite di riparazione / parafuso de fixaçã / šruba mocijuća / Upevňovací šroub

B coated / revêtu / rivestito / revestido / pokryty / povlečený

HC high carbon / à haute teneur en carbone / alto tenore di carbonio / alto teor de carbono / vysokiej węgla /

s vysokým obsahem uhlíku

L alloyed / allié / lega / com liga / stopowe / legovaná

V ventilated / ventilé / ventilato / arejado / wentylowany / větrané

● perforated / perforé / perforata / perforado / perforovaný / perforovaný

		S	B	HC	L	V	A	B	C	D	E	F	G	H	I	OE - #	
<b>B1.G228-0125.1 G2128125</b>			B	HC	L	V●	312,0	28,0	26,0	76,0	112,0	5	67,0	154,0	15,0	MERCEDES BENZ OPEL/VAUXHALL RENAULT	220 421 09 12 40206-00QAH 44 14 632/91165426 77 11 130 077
<b>B1.G228-0142.1 G2128142</b>			B	HC	L	V	312,0	28,0	25,4	64,5	112,0	5	67,0	154,0	15,3	MERCEDES BENZ	211 421 09 12
<b>B1.G228-0154.1 G2128154</b>	S		B	HC		V	300,0	28,0	26,0	52,0	108,0	5	63,5	140,0	15,8	FORD	1420601 1469085 1500158 1517696 6G91-2C375-F1B 7G91-1125-BA
<b>B1.G228-0164.1 G2128164</b>	S		B	HC		V	314,0	28,0	25,0	44,9	110,0	5/7	70,0	139,0	14,0	LAND ROVER VOLVO	LR000571 LR007055 30769056 31202331
<b>B1.G228-0176.1 G2128176</b>			B	HC	L	V	295,0	28,0	25,4	54,5	112,0	5	67,0	154,0	15,3	OPEL/VAUXHALL	5 69 005/93175606
<b>B1.G228-0177.1 G2128177</b>			B	HC	L	V●	330,0	28,0	26,0	46,5	112,0	5	67,0	154,0	13,0	SAAB	24435132 93175606
<b>B1.G228-0203.1 G2128203</b>	S		B	HC	L	V	300,0	28,0	25,0	68,5	130,0	6	85,0	155,0	15,0	MERCEDES BENZ	906 421 00 12
<b>B1.G230-0113.1 G2130113</b>			B	HC		V	320,0	30,0	28,0	46,5	112,0	5/9	68,0	137,0	15,3	VOLKSWAGEN AUDI	2E0 615 301 8D0 615 301 M 8E0 615 301 AD
<b>B1.G230-0114.1 G2130114</b>			B	HC		V	308,0	29,5	25,5	55,6	120,0	5	76,0	154,6	16,6	VOLKSWAGEN	7H0 615 301 D
<b>B1.G230-0115.1 G2130115</b>			B	HC		V	345,0	30,0	27,0	49,9	112,0	5/9	65,0	140,0	15,3	AUDI/SKODAVW	1K0 615 301 M
<b>B1.G230-0175.1 G2130175</b>	S		B	HC		V	321,0	30,0	28,0	59,7	112,0	5	68,0	144,8	15,3	AUDI	4F0 615 301 E
<b>B1.G230-0176.1 G2130176</b>	S		B	HC		V	347,0	30,0	28,0	59,7	112,0	5	68,0	158,0	15,3	AUDI	4F0 615 301 G
<b>B1.G232-0114.1 G2132114</b>			B	HC		V	345,0	31,9	30,0	51,0	112,0	5	67,0	156,5	15,3	MERCEDES BENZ	163 421 05 12
<b>B1.G232-0115.1 G2132115</b>			B	HC	L	V●	330,0	32,0	30,0	76,0	112,0	5	67,0	154,0	15,0	MERCEDES BENZ	220 421 25 12
<b>B1.G232-0144.1 G2132144</b>	S		B	HC	L	V	330,0	32,0	29,4	64,5	112,0	5	67,0	154,0	15,0	MERCEDES BENZ	204 421 29 12 211 421 10 12 211 421 13 12 211 421 14 12
<b>B1.G232-0153.1 G2132153</b>	S		B	HC	L	V●	330,0	32,0	30,0	64,5	112,0	5	67,0	154,0	15,0	MERCEDES BENZ	230 421 08 12
<b>B1.G234-0100.1 G2134100</b>			B	HC		V	360,0	34,0	31,0	59,7	112,0	5	68,0	135,0	15,0	AUDI/VOLKSWAGEN	3D0 615 301 F 4E0 615 301 P

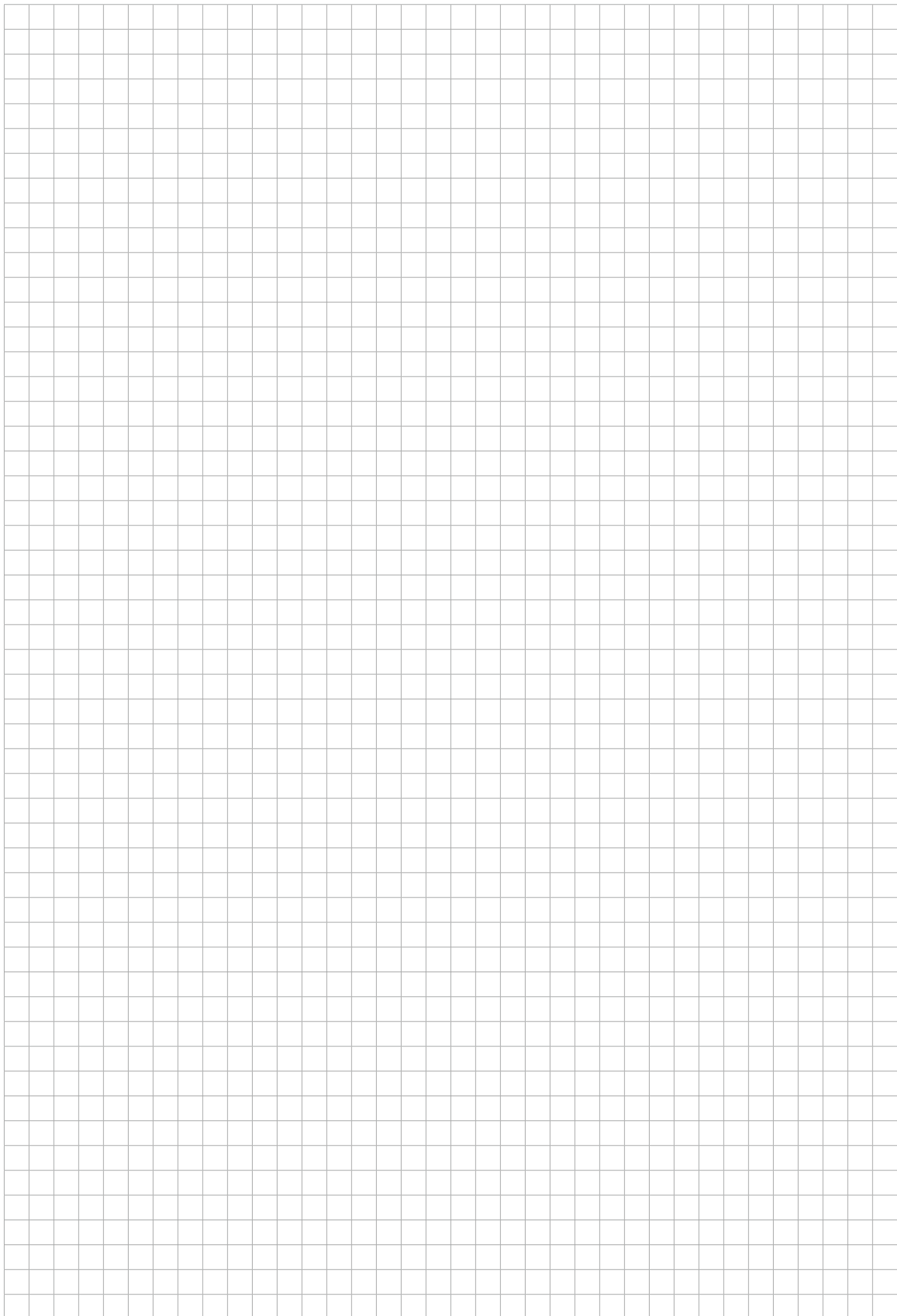

# CROSS REFERENCE LIST WVA – GALFER

Liste des correspondances WVA – GALFER

Tabella di conversione codici WVA – GALFER

Lista de comparação WVA – GALFER

Lista porównawcza numerów WVA – GALFER

Porovnávací seznam čísel WVA – GALFER

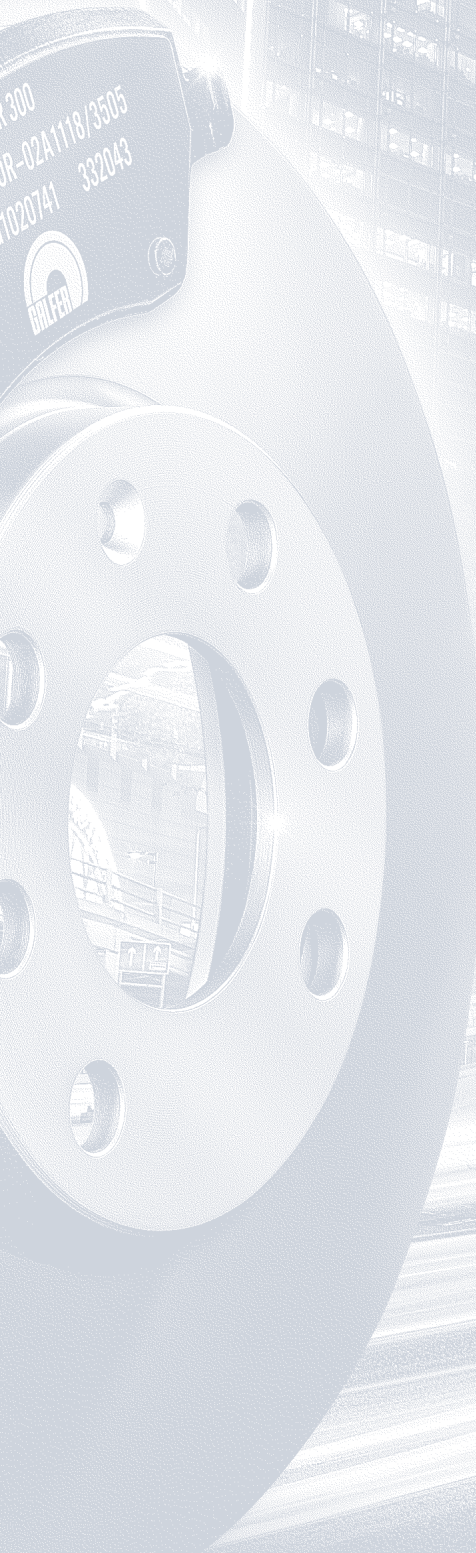













# Cross reference list WVA → GALFER

Liste des correspondances WVA → GALFER / Tabella di conversione codici WVA → GALFER /

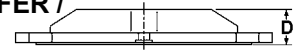
Lista de comparação WVA → GALFER / Lista porównawcza numerów WVA → GALFER /

Porovnávací seznam čísel WVA → GALFER



WVA	D		WVA	D		WVA	D	
24422	17,2	B1.G120-1149.2	G1201149	24635	16,6	B1.G102-0819.2	G1020819	
24438	16,1	B1.G120-5352.2	G1205352	24636	16,6	B1.G102-0819.2	G1020819	
24439	16,1	B1.G120-5352.2	G1205352	24637	16,9	B1.G102-0819.2	G1020819	
24456	19,0	B1.G102-0935.2	G1020935	24638	20,0	B1.G102-0817.2	G1020817	
24465	19,2	B1.G102-0730.2	G1020730	24639	19,3	B1.G102-0817.2	G1020817	
24466	19,1	B1.G102-0764.2	G1020764	24640	19,3	B1.G102-0817.2	G1020817	
24466	19,1	B1.G102-0873.2	G1020873	24660	17,8	B1.G102-0859.2	G1020859	
24467	19,1	B1.G102-0764.2	G1020764	24664	15,2	B1.G102-0768.2	G1020768	
24467	19,1	B1.G102-0873.2	G1020873	24665	15,2	B1.G102-0768.2	G1020768	
24468	19,1	B1.G102-0763.2	G1020763	24666	15,2	B1.G102-0768.2	G1020768	
24468	19,1	B1.G102-0872.2	G1020872	24692	15,9	B1.G102-0874.2	G1020874	
24469	19,1	B1.G102-0763.2	G1020763	24693	17,5	B1.G102-0876.2	G1020876	
24469	19,1	B1.G102-0872.2	G1020872	24693	18,5	B1.G102-0875.2	G1020875	
24483	16,9	B1.G102-0993.2	G1020993	24705	19,8	B1.G102-0823.2	G1020823	
24484	19,0	B1.G102-0801.2	G1020801	24706	21,3	B1.G102-0823.2	G1020823	
24485	19,0	B1.G102-0800.2	G1020800	24707	21,3	B1.G102-0823.2	G1020823	
24486	17,4	B1.G102-0802.2	G1020802	24709	18,6	B1.G102-0834.2	G1020834	
24496	17,3	B1.G102-0787.2	G1020787	24710	18,6	B1.G102-0834.2	G1020834	
24496	17,3	B1.G102-0900.2	G1020900	24743	19,2	B1.G102-0983.2	G1020983	
24498	14,7	B1.G102-0981.2	G1020981	24764	17,9	B1.G102-0952.2	G1020952	
24499	14,7	B1.G102-0981.2	G1020981	24765	16,5	B1.G102-0921.2	G1020921	
24500	14,7	B1.G102-0981.2	G1020981	24862	16,7	B1.G102-0985.2	G1020985	
24510	17,0	B1.G102-0979.2	G1020979	24863	16,7	B1.G102-0985.2	G1020985	
24511	17,0	B1.G102-0979.2	G1020979	24914	17,9	B1.G120-1126.2	G1201126	
24512	17,0	B1.G102-0979.2	G1020979	24922	17,5	B1.G102-0946.2	G1020946	
24515	16,7	B1.G102-0896.2	G1020896	24926	16,5	B1.G120-1209.2	G1201209	
24518	15,8	B1.G120-1014.2	G1201014	24927	17,1	B1.G120-1209.2	G1201209	
24519	15,8	B1.G120-1014.2	G1201014	24928	17,1	B1.G120-1209.2	G1201209	
24521	19,1	B1.G120-1009.2	G1201009	25096	17,0	B1.G102-0953.2	G1020953	
24535	18,3	B1.G102-0871.2	G1020871	25097	17,0	B1.G102-0953.2	G1020953	
24536	18,3	B1.G102-0867.2	G1020867	25098	17,0	B1.G102-0953.2	G1020953	
24537	15,8	B1.G120-1135.2	G1201135	25112	18,4	B1.G102-0907.2	G1020907	
24537	16,1	B1.G102-0786.2	G1020786	25113	18,4	B1.G102-0907.2	G1020907	
24538	17,9	B1.G120-1126.2	G1201126	25147	18,4	B1.G102-0905.2	G1020905	
24538	18,5	B1.G102-0790.2	G1020790	25148	18,4	B1.G102-0905.2	G1020905	
24539	18,5	B1.G102-0790.2	G1020790	25218	16,6	B1.G120-1069.2	G1201069	
24540	16,3	B1.G102-0799.2	G1020799	25222	17,3	B1.G120-1070.2	G1201070	
24549	19,0	B1.G102-0833.2	G1020833	25223	17,3	B1.G120-1070.2	G1201070	
24553	15,8	B1.G120-1079.2	G1201079	29121	20,3	B1.G102-0357.2	G1020357	
24557	19,4	B1.G102-0792.2	G1020792	29153	20,0	B1.G102-0891.2	G1020891	
24558	18,7	B1.G102-0792.2	G1020792	29190	20,2	B1.G102-0766.2	G1020766	
24559	17,8	B1.G120-1213.2	G1201213	29190	20,2	B1.G102-0922.2	G1020922	
24560	17,8	B1.G120-1213.2	G1201213	29192	20,7	B1.G102-0769.2	G1020769	
24574	15,0	B1.G102-0666.2	G1020666	29200	21,0	B1.G102-0770.2	G1020770	
24575	14,8	B1.G102-0666.2	G1020666	29217	20,5	B1.G102-0940.2	G1020940	
24576	14,8	B1.G102-0666.2	G1020666	29229	20,7	B1.G102-0828.2	G1020828	
24578	16,5	B1.G102-0938.2	G1020938	29232	21,0	B1.G102-0825.2	G1020825	
24590	19,0	B1.G102-0988.2	G1020988					
24591	19,0	B1.G102-0988.2	G1020988					
24595	18,5	B1.G102-0937.2	G1020937					
24606	17,4	B1.G120-1004.2	G1201004					
24606	17,4	B1.G120-1005.2	G1201005					
24608	18,5	B1.G102-0937.2	G1020937					
24610	15,0	B1.G102-0975.2	G1020975					
24611	15,0	B1.G102-0975.2	G1020975					
24612	15,0	B1.G102-0975.2	G1020975					
24632	17,0	B1.G102-0866.2	G1020866					



# CROSS REFERENCE LIST GALFER – WVA

Liste des correspondances GALFER – WVA

Tabella di conversione codici GALFER – WVA

Lista de comparação GALFER – WVA

Lista porównawcza numerów GALFER – WVA

Porovnávací seznam čísel GALFER – WVA

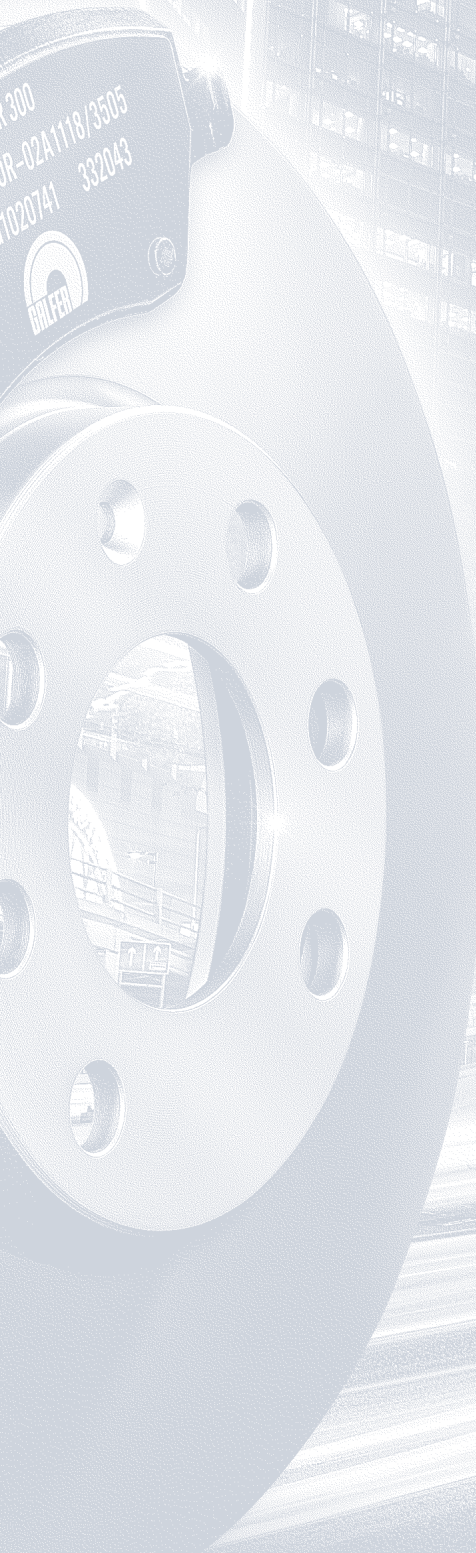

# Cross reference list GALFER → WVA

Liste des correspondances GALFER → WVA / Tabella di conversione codici GALFER → WVA /

Lista de comparação GALFER → WVA / Lista porównawcza numerów GALFER → WVA /

Porovnávací seznam čísel GALFER → WVA

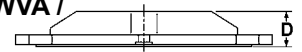

		WVA	D			WVA	D			WVA	D
B1.G102-0009.2	G1020009	20887	19,7	B1.G102-0272.2	G1020272	21140	15,0	B1.G102-0334.2	G1020334	20640	17,5
B1.G102-0009.2	G1020009	20888	19,7	B1.G102-0273.2	G1020273	20168	16,0	B1.G102-0334.2	G1020334	20753	17,5
B1.G102-0010.2	G1020010	20887	15,3	B1.G102-0274.2	G1020274	20168	19,3	B1.G102-0337.2	G1020337	21439	20,3
B1.G102-0010.2	G1020010	20888	15,3	B1.G102-0275.2	G1020275	21191	16,8	B1.G102-0339.2	G1020339	21197	15,0
B1.G102-0015.2	G1020015	20939	15,8	B1.G102-0275.2	G1020275	21267	16,8	B1.G102-0340.2	G1020340	21930	17,9
B1.G102-0022.2	G1020022	20687	13,5	B1.G102-0290.2	G1020290	21832	14,9	B1.G102-0340.2	G1020340	21931	17,9
B1.G102-0025.2	G1020025	20889	17,3	B1.G102-0291.2	G1020291	21275	17,0	B1.G102-0340.2	G1020340	21932	17,9
B1.G102-0026.2	G1020026	20907	18,0	B1.G102-0291.2	G1020291	21276	17,0	B1.G102-0342.2	G1020342	21927	17,9
B1.G102-0026.2	G1020026	20908	18,0	B1.G102-0292.2	G1020292	21430	17,3	B1.G102-0342.2	G1020342	21928	17,9
B1.G102-0028.2	G1020028	20981	13,8	B1.G102-0292.2	G1020292	21432	17,3	B1.G102-0342.2	G1020342	21929	17,9
B1.G102-0044.2	G1020044	20941	19,3	B1.G102-0293.2	G1020293	21430	17,3	B1.G102-0344.2	G1020344	20887	17,3
B1.G102-0044.2	G1020044	21028	19,3	B1.G102-0293.2	G1020293	21827	17,3	B1.G102-0344.2	G1020344	20888	17,3
B1.G102-0046.2	G1020046	20687	15,5	B1.G102-0295.2	G1020295	20905	18,0	B1.G102-0345.2	G1020345	20961	17,0
B1.G102-0065.2	G1020065	20140	14,0	B1.G102-0295.2	G1020295	20906	18,0	B1.G102-0347.2	G1020347	21479	19,2
B1.G102-0065.2	G1020065	20141	14,0	B1.G102-0296.2	G1020296	20905	18,0	B1.G102-0350.2	G1020350	23042	19,0
B1.G102-0097.2	G1020097	20228	15,3	B1.G102-0296.2	G1020296	20906	18,0	B1.G102-0351.2	G1020351	21930	17,9
B1.G102-0140.2	G1020140	20833	17,0	B1.G102-0298.2	G1020298	21436	16,2	B1.G102-0351.2	G1020351	23181	17,9
B1.G102-0140.2	G1020140	20834	17,0	B1.G102-0299.2	G1020299	21614	17,7	B1.G102-0355.2	G1020355	21866	19,7
B1.G102-0140.2	G1020140	20838	17,0	B1.G102-0299.2	G1020299	21615	17,7	B1.G102-0355.2	G1020355	21868	19,7
B1.G102-0140.2	G1020140	20839	17,0	B1.G102-0299.2	G1020299	21616	17,7	B1.G102-0357.2	G1020357	29121	20,3
B1.G102-0141.2	G1020141	20775	18,0	B1.G102-0301.2	G1020301	21797	19,7	B1.G102-0359.2	G1020359	21606	16,7
B1.G102-0141.2	G1020141	20776	18,0	B1.G102-0301.2	G1020301	21798	19,7	B1.G102-0360.2	G1020360	21636	19,3
B1.G102-0141.2	G1020141	20777	18,0	B1.G102-0302.2	G1020302	21799	19,7	B1.G102-0360.2	G1020360	21637	19,3
B1.G102-0147.2	G1020147	20741	19,0	B1.G102-0302.2	G1020302	21800	19,7	B1.G102-0362.2	G1020362	21724	19,3
B1.G102-0147.2	G1020147	20787	19,0	B1.G102-0304.2	G1020304	20124	18,9	B1.G102-0362.2	G1020362	21749	19,3
B1.G102-0184.2	G1020184	21100	16,7	B1.G102-0305.2	G1020305	21436	16,2	B1.G102-0363.2	G1020363	21674	19,0
B1.G102-0184.2	G1020184	21105	16,7	B1.G102-0308.2	G1020308	20995	17,1	B1.G102-0363.2	G1020363	21886	19,0
B1.G102-0196.2	G1020196	20669	19,0	B1.G102-0308.2	G1020308	20996	17,1	B1.G102-0367.2	G1020367	21282	17,3
B1.G102-0196.2	G1020196	20778	19,0	B1.G102-0310.2	G1020310	21801	19,0	B1.G102-0367.2	G1020367	21487	17,3
B1.G102-0197.2	G1020197	20669	19,0	B1.G102-0310.2	G1020310	21802	19,0	B1.G102-0368.2	G1020368	21486	19,3
B1.G102-0197.2	G1020197	20901	19,0	B1.G102-0311.2	G1020311	20676	19,5	B1.G102-0368.2	G1020368	21642	19,3
B1.G102-0201.2	G1020201	20961	15,2	B1.G102-0311.2	G1020311	20678	19,5	B1.G102-0369.2	G1020369	21411	17,5
B1.G102-0213.2	G1020213	20989	17,7	B1.G102-0312.2	G1020312	20676	19,8	B1.G102-0369.2	G1020369	21413	18,3
B1.G102-0213.2	G1020213	21022	17,7	B1.G102-0312.2	G1020312	21624	20,3	B1.G102-0372.2	G1020372	21471	18,0
B1.G102-0213.2	G1020213	21023	17,7	B1.G102-0312.2	G1020312	21646	20,3	B1.G102-0373.2	G1020373	21278	16,4
B1.G102-0214.2	G1020214	20905	18,0	B1.G102-0313.2	G1020313	20676	19,8	B1.G102-0373.2	G1020373	21279	16,4
B1.G102-0214.2	G1020214	20906	18,0	B1.G102-0313.2	G1020313	23018	20,3	B1.G102-0379.2	G1020379	20676	19,8
B1.G102-0214.2	G1020214	20986	18,0	B1.G102-0313.2	G1020313	23019	20,3	B1.G102-0379.2	G1020379	21911	20,3
B1.G102-0214.2	G1020214	20987	18,0	B1.G102-0315.2	G1020315	20651	18,0	B1.G102-0384.2	G1020384	23177	14,2
B1.G102-0215.2	G1020215	20905	18,0	B1.G102-0315.2	G1020315	21635	18,0	B1.G102-0389.2	G1020389	23218	18,0
B1.G102-0215.2	G1020215	20906	18,0	B1.G102-0316.2	G1020316	20180	17,1	B1.G102-0389.2	G1020389	23220	18,0
B1.G102-0216.2	G1020216	20973	11,0	B1.G102-0316.2	G1020316	20181	17,1	B1.G102-0389.2	G1020389	XXXX3	18,0
B1.G102-0216.2	G1020216	20974	11,0	B1.G102-0317.2	G1020317	20547	16,5	B1.G102-0390.2	G1020390	21866	15,3
B1.G102-0219.2	G1020219	20634	15,0	B1.G102-0317.2	G1020317	21353	16,5	B1.G102-0390.2	G1020390	21868	15,3
B1.G102-0219.2	G1020219	21096	15,0	B1.G102-0320.2	G1020320	21394	17,5	B1.G102-0392.2	G1020392	23140	19,4
B1.G102-0219.2	G1020219	21097	15,0	B1.G102-0320.2	G1020320	21396	17,5	B1.G102-0392.2	G1020392	23141	19,4
B1.G102-0236.2	G1020236	21103	14,2	B1.G102-0323.2	G1020323	20634	15,0	B1.G102-0395.2	G1020395	21278	16,9
B1.G102-0246.2	G1020246	21144	15,8	B1.G102-0326.2	G1020326	20919	18,0	B1.G102-0395.2	G1020395	21904	16,9
B1.G102-0257.2	G1020257	21055	17,0	B1.G102-0326.2	G1020326	21388	18,0	B1.G102-0396.2	G1020396	21621	17,3
B1.G102-0258.2	G1020258	21190	17,5	B1.G102-0327.2	G1020327	20410	15,0	B1.G102-0396.2	G1020396	21622	17,3
B1.G102-0258.2	G1020258	21201	17,5	B1.G102-0327.2	G1020327	20423	15,0	B1.G102-0397.2	G1020397	21592	18,8
B1.G102-0259.2	G1020259	21365	17,0	B1.G102-0328.2	G1020328	21631	17,0	B1.G102-0397.2	G1020397	21593	18,8
B1.G102-0265.2	G1020265	21396	17,5	B1.G102-0329.2	G1020329	20162	15,4	B1.G102-0398.2	G1020398	21664	19,8
B1.G102-0265.2	G1020265	21582	17,5	B1.G102-0331.2	G1020331	23130	19,7	B1.G102-0398.2	G1020398	21795	19,8
B1.G102-0269.2	G1020269	21179	16,8	B1.G102-0331.2	G1020331	23131	19,7	B1.G102-0400.2	G1020400	21305	16,1
B1.G102-0269.2	G1020269	21289	16,8	B1.G102-0332.2	G1020333	21202	16,9	B1.G102-0401.2	G1020401	21670	19,4
B1.G102-0271.2	G1020271	21050	15,0	B1.G102-0332.2	G1020333	21203	16,9	B1.G102-0401.2	G1020401	21794	19,4







# Cross reference list GALFER → WVA

Liste des correspondances GALFER → WVA / Tabella di conversione codici GALFER → WVA /

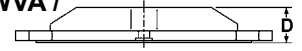
Lista de comparação GALFER → WVA / Lista porównawcza numerów GALFER → WVA /

Porovnávací seznam čísel GALFER → WVA



		WVA D				WVA D				WVA D	
B1.G102-0403.2	G1020403	21829	20,3	B1.G102-0484.2	G1020484	21927	17,9	B1.G102-0542.2	G1020542	23064	17,5
B1.G102-0403.2	G1020403	23115	19,8	B1.G102-0484.2	G1020484	21928	17,9	B1.G102-0542.2	G1020542	23065	17,5
B1.G102-0408.2	G1020408	21866	17,2	B1.G102-0487.2	G1020487	21278	16,4	B1.G102-0542.2	G1020542	23066	18,5
B1.G102-0408.2	G1020408	21868	17,2	B1.G102-0489.2	G1020489	23554	16,3	B1.G102-0542.2	G1020542	23067	18,5
B1.G102-0409.2	G1020409	21866	17,2	B1.G102-0492.2	G1020492	23554	17,1	B1.G102-0544.2	G1020544	23138	14,6
B1.G102-0409.2	G1020409	21868	17,2	B1.G102-0496.2	G1020496	20907	18,1	B1.G102-0545.2	G1020545	23225	17,0
B1.G102-0409.2	G1020409	23752	17,2	B1.G102-0496.2	G1020496	23842	18,1	B1.G102-0545.2	G1020545	23226	17,0
B1.G102-0411.2	G1020411	21676	20,3	B1.G102-0497.2	G1020497	21980	18,0	B1.G102-0547.2	G1020547	23245	18,3
B1.G102-0411.2	G1020411	21677	20,3	B1.G102-0497.2	G1020497	21981	18,0	B1.G102-0547.2	G1020547	23247	18,3
B1.G102-0415.2	G1020415	21691	17,1	B1.G102-0500.2	G1020500	23140	19,4	B1.G102-0548.2	G1020548	23245	18,3
B1.G102-0415.2	G1020415	21891	17,1	B1.G102-0500.2	G1020500	23141	19,4	B1.G102-0548.2	G1020548	23248	18,3
B1.G102-0419.2	G1020419	21883	19,8	B1.G102-0500.2	G1020500	24095	19,4	B1.G102-0549.2	G1020549	20961	17,1
B1.G102-0419.2	G1020419	21885	20,4	B1.G102-0501.2	G1020501	21463	18,2	B1.G102-0550.2	G1020550	23057	20,2
B1.G102-0421.2	G1020421	21945	19,6	B1.G102-0503.2	G1020503	23709	19,0	B1.G102-0550.2	G1020550	23058	19,6
B1.G102-0422.2	G1020422	21900	15,0	B1.G102-0503.2	G1020503	23710	19,0	B1.G102-0550.2	G1020550	23059	19,6
B1.G102-0423.2	G1020423	21171	18,0	B1.G102-0504.2	G1020504	23711	19,4	B1.G102-0550.2	G1020550	XXXX2	20,2
B1.G102-0423.2	G1020423	23300	18,0	B1.G102-0504.2	G1020504	23712	19,4	B1.G102-0554.2	G1020554	23258	16,5
B1.G102-0423.2	G1020423	23301	18,0	B1.G102-0504.2	G1020504	23713	19,4	B1.G102-0554.2	G1020554	23259	16,5
B1.G102-0427.2	G1020427	23218	18,0	B1.G102-0505.2	G1020505	23154	19,4	B1.G102-0554.2	G1020554	23262	16,5
B1.G102-0427.2	G1020427	23220	18,0	B1.G102-0505.2	G1020505	23155	19,4	B1.G102-0554.2	G1020554	23263	16,5
B1.G102-0427.2	G1020427	XXXX3	18,0	B1.G102-0507.2	G1020507	23353	14,6	B1.G102-0557.2	G1020557	21848	19,8
B1.G102-0440.2	G1020440	23070	16,9	B1.G102-0510.2	G1020510	20755	15,1	B1.G102-0557.2	G1020557	21849	20,3
B1.G102-0441.2	G1020441	21919	15,3	B1.G102-0511.2	G1020511	21945	19,6	B1.G102-0557.2	G1020557	23324	20,3
B1.G102-0442.2	G1020442	21899	15,3	B1.G102-0511.2	G1020511	23393	19,6	B1.G102-0559.2	G1020559	23554	16,3
B1.G102-0443.2	G1020443	21857	17,7	B1.G102-0512.2	G1020512	20676	19,8	B1.G102-0560.2	G1020560	23284	14,0
B1.G102-0444.2	G1020444	21945	16,0	B1.G102-0512.2	G1020512	21911	20,3	B1.G102-0562.2	G1020562	23279	18,4
B1.G102-0448.2	G1020448	20907	18,1	B1.G102-0512.2	G1020512	23392	20,3	B1.G102-0563.2	G1020563	23557	17,2
B1.G102-0448.2	G1020448	23552	18,1	B1.G102-0513.2	G1020513	23332	18,0	B1.G102-0564.2	G1020564	20961	16,8
B1.G102-0451.2	G1020451	23124	19,0	B1.G102-0513.2	G1020513	23333	18,0	B1.G102-0564.2	G1020564	23516	16,8
B1.G102-0451.2	G1020451	23125	19,0	B1.G102-0514.2	G1020514	20261	19,0	B1.G102-0566.2	G1020566	23554	17,1
B1.G102-0457.2	G1020457	21920	14,6	B1.G102-0514.2	G1020514	20267	19,0	B1.G102-0566.2	G1020566	23823	17,1
B1.G102-0458.2	G1020458	21861	15,2	B1.G102-0515.2	G1020515	23714	16,6	B1.G102-0567.2	G1020567	23601	13,7
B1.G102-0459.2	G1020459	21888	18,1	B1.G102-0516.2	G1020516	23917	19,3	B1.G102-0568.2	G1020568	23517	16,6
B1.G102-0459.2	G1020459	21889	18,1	B1.G102-0516.2	G1020516	23918	19,3	B1.G102-0569.2	G1020569	23172	18,0
B1.G102-0463.2	G1020463	23130	19,7	B1.G102-0517.2	G1020517	23919	19,3	B1.G102-0570.2	G1020570	23346	19,0
B1.G102-0463.2	G1020463	23131	19,7	B1.G102-0517.2	G1020517	23920	19,3	B1.G102-0572.2	G1020572	23760	17,7
B1.G102-0463.2	G1020463	23187	19,7	B1.G102-0518.2	G1020518	23921	20,3	B1.G102-0573.2	G1020573	24073	16,7
B1.G102-0467.2	G1020467	23200	18,0	B1.G102-0519.2	G1020519	23202	17,8	B1.G102-0574.2	G1020574	23271	17,6
B1.G102-0467.2	G1020467	23201	18,0	B1.G102-0519.2	G1020519	23604	17,8	B1.G102-0575.2	G1020575	23157	15,8
B1.G102-0469.2	G1020469	21930	17,9	B1.G102-0522.2	G1020522	20974	10,7	B1.G102-0576.2	G1020576	23215	18,3
B1.G102-0469.2	G1020469	21931	17,9	B1.G102-0524.2	G1020524	21479	19,2	B1.G102-0576.2	G1020576	23217	18,3
B1.G102-0470.2	G1020470	23482	15,8	B1.G102-0524.2	G1020524	23445	19,2	B1.G102-0578.2	G1020578	23073	18,8
B1.G102-0470.2	G1020470	23483	15,8	B1.G102-0527.2	G1020527	23034	18,8	B1.G102-0578.2	G1020578	23074	18,8
B1.G102-0473.2	G1020473	21637	19,3	B1.G102-0527.2	G1020527	23036	19,4	B1.G102-0580.2	G1020580	23269	19,8
B1.G102-0473.2	G1020473	21641	19,3	B1.G102-0527.2	G1020527	XXXX3	19,4	B1.G102-0580.2	G1020580	23270	19,8
B1.G102-0473.2	G1020473	23289	19,3	B1.G102-0529.2	G1020529	23980	16,5	B1.G102-0582.2	G1020582	23022	20,9
B1.G102-0474.2	G1020474	20968	20,3	B1.G102-0533.2	G1020533	20651	18,3	B1.G102-0583.2	G1020583	23021	18,9
B1.G102-0474.2	G1020474	21064	20,3	B1.G102-0533.2	G1020533	21635	18,7	B1.G102-0584.2	G1020584	23020	17,9
B1.G102-0478.2	G1020478	23340	17,0	B1.G102-0533.2	G1020533	23176	18,7	B1.G102-0586.2	G1020586	23793	20,3
B1.G102-0478.2	G1020478	23341	17,0	B1.G102-0534.2	G1020534	21883	19,8	B1.G102-0586.2	G1020586	23794	20,3
B1.G102-0478.2	G1020478	23342	17,0	B1.G102-0534.2	G1020534	21885	20,4	B1.G102-0588.2	G1020588	23732	17,3
B1.G102-0480.2	G1020480	23076	17,5	B1.G102-0534.2	G1020534	23163	20,4	B1.G102-0588.2	G1020588	23737	17,3
B1.G102-0480.2	G1020480	23077	17,5	B1.G102-0537.2	G1020537	21983	17,2	B1.G102-0591.2	G1020591	21676	20,3
B1.G102-0482.2	G1020482	21797	19,7	B1.G102-0538.2	G1020538	23973	17,2	B1.G102-0591.2	G1020591	23183	20,3
B1.G102-0482.2	G1020482	23602	19,7	B1.G102-0540.2	G1020540	21999	15,8	B1.G102-0593.2	G1020593	23034	18,8
B1.G102-0483.2	G1020483	21799	19,7	B1.G102-0540.2	G1020540	23001	15,8	B1.G102-0593.2	G1020593	23418	19,4
B1.G102-0483.2	G1020483	23603	19,7	B1.G102-0542.2	G1020542	23063	17,5	B1.G102-0593.2	G1020593	23419	19,4

# Cross reference list GALFER → WVA

Liste des correspondances GALFER → WVA / Tabella di conversione codici GALFER → WVA /

Lista de comparação GALFER → WVA / Lista porównawcza numerów GALFER → WVA /

Porovnávací seznam čísel GALFER → WVA

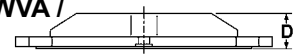

GALFER		WVA D		GALFER		WVA D		GALFER		WVA D	
B1.G102-0595.2	G1020595	23434	18,7	B1.G102-0658.2	G1020658	23446	16,5	B1.G102-0711.2	G1020711	23694	16,4
B1.G102-0595.2	G1020595	23435	18,7	B1.G102-0659.2	G1020659	23945	16,5	B1.G102-0712.2	G1020712	23766	17,8
B1.G102-0595.2	G1020595	23840	18,7	B1.G102-0660.2	G1020660	24135	17,7	B1.G102-0712.2	G1020712	23818	17,8
B1.G102-0595.2	G1020595	23841	18,7	B1.G102-0661.2	G1020661	24077	19,1	B1.G102-0712.2	G1020712	23819	17,8
B1.G102-0597.2	G1020597	23577	18,7	B1.G102-0662.2	G1020662	23480	19,3	B1.G102-0713.2	G1020713	23816	16,0
B1.G102-0597.2	G1020597	23578	18,7	B1.G102-0662.2	G1020662	23481	19,3	B1.G102-0714.2	G1020714	23510	16,5
B1.G102-0597.2	G1020597	23579	18,7	B1.G102-0662.2	G1020662	23768	19,3	B1.G102-0714.2	G1020714	23511	16,5
B1.G102-0597.2	G1020597	23580	18,7	B1.G102-0663.2	G1020663	23620	16,4	B1.G102-0714.2	G1020714	23512	16,5
B1.G102-0602.2	G1020602	23277	17,7	B1.G102-0663.2	G1020663	23621	16,4	B1.G102-0719.2	G1020719	24046	18,6
B1.G102-0603.2	G1020603	23273	17,8	B1.G102-0663.2	G1020663	23622	16,4	B1.G102-0719.2	G1020719	24047	18,6
B1.G102-0604.2	G1020604	23305	15,2	B1.G102-0666.2	G1020666	24574	15,0	B1.G102-0719.2	G1020719	24048	18,6
B1.G102-0605.2	G1020605	23605	15,7	B1.G102-0666.2	G1020666	24575	14,8	B1.G102-0721.2	G1020721	24045	13,7
B1.G102-0605.2	G1020605	23607	15,7	B1.G102-0666.2	G1020666	24576	14,8	B1.G102-0722.2	G1020722	21694	16,3
B1.G102-0608.2	G1020608	21643	17,8	B1.G102-0670.2	G1020670	23482	16,6	B1.G102-0722.2	G1020722	21695	16,3
B1.G102-0608.2	G1020608	21644	17,8	B1.G102-0670.2	G1020670	24137	16,6	B1.G102-0722.2	G1020722	21696	16,3
B1.G102-0610.2	G1020610	23417	15,3	B1.G102-0672.2	G1020672	24348	17,1	B1.G102-0727.2	G1020727	23482	16,6
B1.G102-0610.2	G1020610	23654	15,3	B1.G102-0676.2	G1020676	20961	15,8	B1.G102-0727.2	G1020727	24137	16,6
B1.G102-0610.2	G1020610	23655	15,3	B1.G102-0677.2	G1020677	23271	17,6	B1.G102-0730.2	G1020730	24465	19,2
B1.G102-0613.2	G1020613	24072	17,9	B1.G102-0677.2	G1020677	23745	17,6	B1.G102-0732.2	G1020732	23581	18,8
B1.G102-0614.2	G1020614	23708	19,0	B1.G102-0677.2	G1020677	XXXX3	17,6	B1.G102-0733.2	G1020733	23581	18,8
B1.G102-0615.2	G1020615	23070	19,4	B1.G102-0677.2	G1020677	XXXX4	17,6	B1.G102-0733.2	G1020733	23843	18,8
B1.G102-0617.2	G1020617	21470	18,0	B1.G102-0678.2	G1020678	23896	20,6	B1.G102-0734.2	G1020734	23914	17,1
B1.G102-0618.2	G1020618	21469	18,0	B1.G102-0678.2	G1020678	23897	20,6	B1.G102-0735.2	G1020735	23600	19,4
B1.G102-0621.2	G1020621	21436	17,0	B1.G102-0680.2	G1020680	23587	20,6	B1.G102-0737.2	G1020737	23706	18,0
B1.G102-0622.2	G1020622	23723	18,1	B1.G102-0680.2	G1020680	23588	20,6	B1.G102-0737.2	G1020737	23707	18,0
B1.G102-0622.2	G1020622	23724	18,1	B1.G102-0680.2	G1020680	23589	20,6	B1.G102-0738.2	G1020738	23709	19,0
B1.G102-0624.2	G1020624	23613	17,7	B1.G102-0682.2	G1020682	23914	17,1	B1.G102-0738.2	G1020738	23710	19,0
B1.G102-0625.2	G1020625	24260	16,4	B1.G102-0683.2	G1020683	21484	20,5	B1.G102-0740.2	G1020740	23706	18,0
B1.G102-0627.2	G1020627	23669	16,8	B1.G102-0683.2	G1020683	21485	20,5	B1.G102-0740.2	G1020740	23707	18,0
B1.G102-0630.2	G1020630	24150	17,6	B1.G102-0685.2	G1020685	23930	18,2	B1.G102-0741.2	G1020741	23973	17,1
B1.G102-0632.2	G1020632	23743	20,1	B1.G102-0686.2	G1020686	23407	19,0	B1.G102-0742.2	G1020742	21576	20,7
B1.G102-0632.2	G1020632	23744	20,1	B1.G102-0687.2	G1020687	23409	19,3	B1.G102-0742.2	G1020742	21577	20,7
B1.G102-0633.2	G1020633	23099	18,4	B1.G102-0691.2	G1020691	23326	17,4	B1.G102-0745.2	G1020745	23589	19,1
B1.G102-0634.2	G1020634	23312	20,3	B1.G102-0692.2	G1020692	23440	17,6	B1.G102-0745.2	G1020745	24153	19,1
B1.G102-0634.2	G1020634	23347	20,3	B1.G102-0692.2	G1020692	23441	18,1	B1.G102-0746.2	G1020746	23791	20,8
B1.G102-0637.2	G1020637	21282	17,3	B1.G102-0694.2	G1020694	23590	19,5	B1.G102-0746.2	G1020746	23792	20,8
B1.G102-0637.2	G1020637	23447	17,3	B1.G102-0694.2	G1020694	23591	18,0	B1.G102-0751.2	G1020751	24007	20,8
B1.G102-0638.2	G1020638	23309	17,3	B1.G102-0696.2	G1020696	24141	19,1	B1.G102-0752.2	G1020752	24008	18,3
B1.G102-0638.2	G1020638	23310	17,3	B1.G102-0696.2	G1020696	24142	20,6	B1.G102-0753.2	G1020753	23801	20,3
B1.G102-0642.2	G1020642	21829	20,3	B1.G102-0698.2	G1020698	24367	19,1	B1.G102-0753.2	G1020753	23912	20,3
B1.G102-0642.2	G1020642	23116	19,8	B1.G102-0698.2	G1020698	24368	19,1	B1.G102-0753.2	G1020753	23913	20,3
B1.G102-0642.2	G1020642	23117	19,8	B1.G102-0698.2	G1020698	XXXX3	19,1	B1.G102-0754.2	G1020754	23763	20,3
B1.G102-0644.2	G1020644	23762	20,3	B1.G102-0699.2	G1020699	24367	19,1	B1.G102-0754.2	G1020754	23801	20,3
B1.G102-0644.2	G1020644	23763	20,3	B1.G102-0699.2	G1020699	24368	19,1	B1.G102-0754.2	G1020754	23950	20,3
B1.G102-0646.2	G1020646	23281	18,3	B1.G102-0699.2	G1020699	XXXX3	19,1	B1.G102-0755.2	G1020755	20961	17,1
B1.G102-0646.2	G1020646	23282	18,3	B1.G102-0701.2	G1020701	24339	20,5	B1.G102-0756.2	G1020756	23404	20,6
B1.G102-0648.2	G1020648	23716	15,8	B1.G102-0701.2	G1020701	24340	20,3	B1.G102-0756.2	G1020756	23405	20,1
B1.G102-0648.2	G1020648	23717	15,8	B1.G102-0704.2	G1020704	23749	19,1	B1.G102-0756.2	G1020756	XXXX2	20,6
B1.G102-0650.2	G1020650	23378	20,1	B1.G102-0704.2	G1020704	23835	19,6	B1.G102-0758.2	G1020758	23326	17,4
B1.G102-0650.2	G1020650	23379	20,1	B1.G102-0706.2	G1020706	23746	18,1	B1.G102-0759.2	G1020759	23326	17,4
B1.G102-0650.2	G1020650	23402	20,1	B1.G102-0706.2	G1020706	23747	18,1	B1.G102-0761.2	G1020761	24134	19,6
B1.G102-0650.2	G1020650	23403	20,1	B1.G102-0706.2	G1020706	23749	17,6	B1.G102-0761.2	G1020761	24175	19,6
B1.G102-0652.2	G1020652	23334	16,7	B1.G102-0707.2	G1020707	23746	19,7	B1.G102-0762.2	G1020762	24133	18,6
B1.G102-0652.2	G1020652	23335	16,7	B1.G102-0707.2	G1020707	23747	19,7	B1.G102-0762.2	G1020762	24174	18,6
B1.G102-0654.2	G1020654	23224	16,5	B1.G102-0707.2	G1020707	23749	18,7	B1.G102-0763.2	G1020763	24468	19,1
B1.G102-0654.2	G1020654	23446	16,5	B1.G102-0709.2	G1020709	23692	16,6	B1.G102-0763.2	G1020763	24469	19,1
B1.G102-0658.2	G1020658	23224	16,5	B1.G102-0710.2	G1020710	23693	16,6	B1.G102-0763.2	G1020763	XXXX3	19,1



# Cross reference list GALFER → WVA

Liste des correspondances GALFER → WVA / Tabella di conversione codici GALFER → WVA /

Lista de comparação GALFER → WVA / Lista porównawcza numerów GALFER → WVA /

Porovnávací seznam čísel GALFER → WVA

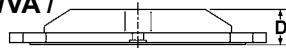

		WVA	D			WVA	D			WVA	D
B1.G102-0764.2	G1020764	24466	19,1	B1.G102-0825.2	G1020825	29232	21,0	B1.G102-0895.2	G1020895	23912	20,3
B1.G102-0764.2	G1020764	24467	19,1	B1.G102-0828.2	G1020828	29229	20,7	B1.G102-0895.2	G1020895	23913	20,3
B1.G102-0765.2	G1020765	23832	20,2	B1.G102-0829.2	G1020829	23881	20,0	B1.G102-0896.2	G1020896	24073	16,7
B1.G102-0765.2	G1020765	23833	20,2	B1.G102-0830.2	G1020830	23959	17,0	B1.G102-0896.2	G1020896	24515	16,7
B1.G102-0765.2	G1020765	23844	20,5	B1.G102-0833.2	G1020833	23981	19,0	B1.G102-0900.2	G1020900	24496	17,3
B1.G102-0765.2	G1020765	XXXX2	20,5	B1.G102-0833.2	G1020833	24549	19,0	B1.G102-0901.2	G1020901	23615	18,3
B1.G102-0766.2	G1020766	29190	20,2	B1.G102-0834.2	G1020834	24709	18,6	B1.G102-0905.2	G1020905	25147	18,4
B1.G102-0766.2	G1020766	XXXX2	20,2	B1.G102-0834.2	G1020834	24710	18,6	B1.G102-0905.2	G1020905	25148	18,4
B1.G102-0768.2	G1020768	24664	15,2	B1.G102-0836.2	G1020836	23738	20,1	B1.G102-0907.2	G1020907	25112	18,4
B1.G102-0768.2	G1020768	24665	15,2	B1.G102-0836.2	G1020836	23739	20,1	B1.G102-0907.2	G1020907	25113	18,4
B1.G102-0768.2	G1020768	24666	15,2	B1.G102-0844.2	G1020844	23623	17,4	B1.G102-0920.2	G1020920	23554	16,8
B1.G102-0769.2	G1020769	29192	20,7	B1.G102-0844.2	G1020844	23624	17,4	B1.G102-0921.2	G1020921	24765	16,5
B1.G102-0770.2	G1020770	29200	21,0	B1.G102-0846.2	G1020846	23935	17,8	B1.G102-0922.2	G1020922	29190	20,2
B1.G102-0772.2	G1020772	23801	18,6	B1.G102-0846.2	G1020846	23999	17,8	B1.G102-0922.2	G1020922	XXXX2	20,2
B1.G102-0772.2	G1020772	23912	18,6	B1.G102-0848.2	G1020848	23794	20,3	B1.G102-0924.2	G1020924	23144	19,8
B1.G102-0774.2	G1020774	24391	16,6	B1.G102-0848.2	G1020848	23968	20,3	B1.G102-0924.2	G1020924	23145	19,8
B1.G102-0774.2	G1020774	24392	16,6	B1.G102-0850.2	G1020850	23926	17,3	B1.G102-0925.2	G1020925	23144	19,8
B1.G102-0776.2	G1020776	21670	19,3	B1.G102-0850.2	G1020850	23927	17,3	B1.G102-0925.2	G1020925	23145	19,8
B1.G102-0776.2	G1020776	21794	19,3	B1.G102-0852.2	G1020852	23138	14,6	B1.G102-0928.2	G1020928	24034	19,1
B1.G102-0777.2	G1020777	21597	11,0	B1.G102-0855.2	G1020855	24077	19,1	B1.G102-0928.2	G1020928	24035	19,1
B1.G102-0777.2	G1020777	21600	11,0	B1.G102-0856.2	G1020856	23984	17,8	B1.G102-0928.2	G1020928	24036	19,1
B1.G102-0779.2	G1020779	21920	16,6	B1.G102-0856.2	G1020856	23985	17,8	B1.G102-0933.2	G1020933	24306	20,3
B1.G102-0780.2	G1020780	21861	15,2	B1.G102-0858.2	G1020858	23707	18,0	B1.G102-0934.2	G1020934	24306	20,3
B1.G102-0785.2	G1020785	23330	17,0	B1.G102-0858.2	G1020858	24288	18,0	B1.G102-0935.2	G1020935	24310	19,0
B1.G102-0786.2	G1020786	24537	16,1	B1.G102-0859.2	G1020859	24660	17,8	B1.G102-0935.2	G1020935	24456	19,0
B1.G102-0787.2	G1020787	24496	17,3	B1.G102-0860.2	G1020860	23922	21,0	B1.G102-0935.2	G1020935	XXXX3	19,0
B1.G102-0790.2	G1020790	24538	18,5	B1.G102-0860.2	G1020860	23925	20,5	B1.G102-0937.2	G1020937	24595	18,5
B1.G102-0790.2	G1020790	24539	18,5	B1.G102-0862.2	G1020862	23923	17,6	B1.G102-0937.2	G1020937	24608	18,5
B1.G102-0792.2	G1020792	24557	19,4	B1.G102-0862.2	G1020862	23924	17,6	B1.G102-0938.2	G1020938	24578	16,5
B1.G102-0792.2	G1020792	24558	18,7	B1.G102-0866.2	G1020866	24632	17,0	B1.G102-0939.2	G1020939	23313	20,3
B1.G102-0794.2	G1020794	23915	17,6	B1.G102-0867.2	G1020867	23245	18,3	B1.G102-0939.2	G1020939	24255	20,3
B1.G102-0794.2	G1020794	23916	17,6	B1.G102-0867.2	G1020867	24536	18,3	B1.G102-0940.2	G1020940	29217	20,5
B1.G102-0796.2	G1020796	24289	16,9	B1.G102-0871.2	G1020871	23215	18,3	B1.G102-0946.2	G1020946	24922	17,5
B1.G102-0796.2	G1020796	24290	16,9	B1.G102-0871.2	G1020871	24535	18,3	B1.G102-0951.2	G1020951	21436	17,0
B1.G102-0798.2	G1020798	23202	17,8	B1.G102-0872.2	G1020872	24468	19,1	B1.G102-0952.2	G1020952	24072	17,9
B1.G102-0798.2	G1020798	24022	17,8	B1.G102-0872.2	G1020872	24469	19,1	B1.G102-0952.2	G1020952	24764	17,9
B1.G102-0798.2	G1020798	24023	17,8	B1.G102-0872.2	G1020872	XXXX3	19,1	B1.G102-0953.2	G1020953	25096	17,0
B1.G102-0799.2	G1020799	24540	16,3	B1.G102-0873.2	G1020873	24466	19,1	B1.G102-0953.2	G1020953	25097	17,0
B1.G102-0800.2	G1020800	24485	19,0	B1.G102-0873.2	G1020873	24467	19,1	B1.G102-0953.2	G1020953	25098	17,0
B1.G102-0801.2	G1020801	24484	19,0	B1.G102-0874.2	G1020874	24692	15,9	B1.G102-0955.2	G1020955	21385	13,0
B1.G102-0802.2	G1020802	24486	17,4	B1.G102-0875.2	G1020875	24693	18,5	B1.G102-0956.2	G1020956	21273	19,5
B1.G102-0803.2	G1020803	21282	17,3	B1.G102-0876.2	G1020876	24693	17,5	B1.G102-0956.2	G1020956	21274	19,5
B1.G102-0803.2	G1020803	23447	17,3	B1.G102-0877.2	G1020877	23960	18,3	B1.G102-0963.2	G1020963	24253	17,8
B1.G102-0806.2	G1020806	24170	20,2	B1.G102-0882.2	G1020882	23329	17,0	B1.G102-0963.2	G1020963	24254	18,0
B1.G102-0806.2	G1020806	24171	20,9	B1.G102-0883.2	G1020883	21792	15,2	B1.G102-0971.2	G1020971	23347	20,3
B1.G102-0812.2	G1020812	23720	17,5	B1.G102-0885.2	G1020885	21586	15,0	B1.G102-0971.2	G1020971	24161	20,3
B1.G102-0812.2	G1020812	24213	17,5	B1.G102-0886.2	G1020886	21586	15,0	B1.G102-0974.2	G1020974	24347	17,5
B1.G102-0812.2	G1020812	24214	17,5	B1.G102-0886.2	G1020886	23410	15,0	B1.G102-0975.2	G1020975	24610	15,0
B1.G102-0817.2	G1020817	24638	20,0	B1.G102-0886.2	G1020886	23411	15,0	B1.G102-0975.2	G1020975	24611	15,0
B1.G102-0817.2	G1020817	24639	19,3	B1.G102-0887.2	G1020887	23550	17,3	B1.G102-0975.2	G1020975	24612	15,0
B1.G102-0817.2	G1020817	24640	19,3	B1.G102-0887.2	G1020887	23551	17,3	B1.G102-0979.2	G1020979	24510	17,0
B1.G102-0819.2	G1020819	24635	16,6	B1.G102-0889.2	G1020889	24123	20,3	B1.G102-0979.2	G1020979	24511	17,0
B1.G102-0819.2	G1020819	24636	16,6	B1.G102-0889.2	G1020889	24124	19,3	B1.G102-0979.2	G1020979	24512	17,0
B1.G102-0819.2	G1020819	24637	16,9	B1.G102-0891.2	G1020891	29153	20,0	B1.G102-0981.2	G1020981	24498	14,7
B1.G102-0823.2	G1020823	24705	19,8	B1.G102-0893.2	G1020893	24084	19,3	B1.G102-0981.2	G1020981	24499	14,7
B1.G102-0823.2	G1020823	24706	21,3	B1.G102-0893.2	G1020893	24332	18,3	B1.G102-0981.2	G1020981	24500	14,7
B1.G102-0823.2	G1020823	24707	21,3	B1.G102-0895.2	G1020895	23801	20,3	B1.G102-0983.2	G1020983	24408	19,2



# Cross reference list GALFER → WVA

Liste des correspondances GALFER → WVA / Tabella di conversione codici GALFER → WVA /

Lista de comparação GALFER → WVA / Lista porównawcza numerów GALFER → WVA /

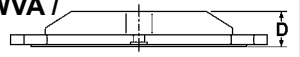
Porovnávací seznam čísel GALFER → WVA



 WVA	D	 WVA	D	 WVA	D						
B1.G102-0983.2	G1020983	24409	19,2	B1.G120-1065.2	G1201065	24336	17,5	B1.G120-5344.2	G1205344	23530	16,6
B1.G102-0983.2	G1020983	24743	19,2	B1.G120-1066.2	G1201066	23961	16,8	B1.G120-5344.2	G1205344	23531	16,6
B1.G102-0985.2	G1020985	24862	16,7	B1.G120-1069.2	G1201069	23482	16,6	B1.G120-5352.2	G1205352	24438	16,1
B1.G102-0985.2	G1020985	24863	16,7	B1.G120-1069.2	G1201069	25218	16,6	B1.G120-5352.2	G1205352	24439	16,1
B1.G102-0987.2	G1020987	23707	18,0	B1.G120-1070.2	G1201070	25222	17,3	B1.G120-5366.2	G1205366	23807	18,6
B1.G102-0988.2	G1020988	24122	19,0	B1.G120-1070.2	G1201070	25223	17,3	B1.G120-5366.2	G1205366	23969	18,6
B1.G102-0988.2	G1020988	24590	19,0	B1.G120-1073.2	G1201073	24084	19,3	B1.G120-5404.2	G1205404	21947	15,4
B1.G102-0988.2	G1020988	24591	19,0	B1.G120-1073.2	G1201073	24332	18,3	B1.G120-5418.2	G1205418	23865	17,6
B1.G102-0992.2	G1020992	24332	19,8	B1.G120-1079.2	G1201079	24553	15,8	B1.G120-5418.2	G1205418	23867	17,6
B1.G102-0992.2	G1020992	24333	21,3	B1.G120-1085.2	G1201085	24346	16,4				
B1.G102-0992.2	G1020992	24334	21,3	B1.G120-1126.2	G1201126	24538	17,9				
B1.G102-0993.2	G1020993	24483	16,9	B1.G120-1126.2	G1201126	24914	17,9				
B1.G102-0994.2	G1020994	24337	17,5	B1.G120-1128.2	G1201128	23714	17,6				
B1.G102-0995.2	G1020995	24150	17,6	B1.G120-1128.2	G1201128	XXXX2	17,6				
B1.G102-0999.2	G1020999	24296	15,5	B1.G120-1128.2	G1201128	XXXX3	17,6				
B1.G120-1000.2	G1201000	21738	13,5	B1.G120-1135.2	G1201135	24537	15,8				
B1.G120-1000.2	G1201000	23343	13,5	B1.G120-1143.2	G1201143	24415	19,1				
B1.G120-1000.2	G1201000	23344	13,5	B1.G120-1143.2	G1201143	24416	19,1				
B1.G120-1002.2	G1201002	23966	17,7	B1.G120-1143.2	G1201143	24417	19,1				
B1.G120-1002.2	G1201002	23987	17,7	B1.G120-1145.2	G1201145	24412	19,0				
B1.G120-1002.2	G1201002	23988	17,7	B1.G120-1145.2	G1201145	24413	19,0				
B1.G120-1004.2	G1201004	24606	17,4	B1.G120-1145.2	G1201145	24414	19,0				
B1.G120-1004.2	G1201004	XXXX2	17,7	B1.G120-1147.2	G1201147	24418	17,0				
B1.G120-1005.2	G1201005	24606	17,4	B1.G120-1147.2	G1201147	24419	17,0				
B1.G120-1005.2	G1201005	XXXX2	17,7	B1.G120-1147.2	G1201147	24420	17,0				
B1.G120-1009.2	G1201009	24142	20,6	B1.G120-1148.2	G1201148	24421	17,2				
B1.G120-1009.2	G1201009	24521	19,1	B1.G120-1148.2	G1201148	24422	17,2				
B1.G120-1010.2	G1201010	24098	17,1	B1.G120-1149.2	G1201149	24421	17,2				
B1.G120-1011.2	G1201011	24097	17,1	B1.G120-1149.2	G1201149	24422	17,2				
B1.G120-1013.2	G1201013	24087	17,4	B1.G120-1209.2	G1201209	24926	16,5				
B1.G120-1013.2	G1201013	24405	17,4	B1.G120-1209.2	G1201209	24927	17,1				
B1.G120-1013.2	G1201013	24406	17,4	B1.G120-1209.2	G1201209	24928	17,1				
B1.G120-1014.2	G1201014	24086	15,8	B1.G120-1213.2	G1201213	24559	17,8				
B1.G120-1014.2	G1201014	24518	15,8	B1.G120-1213.2	G1201213	24560	17,8				
B1.G120-1014.2	G1201014	24519	15,8	B1.G120-1224.2	G1201224	23706	18,0				
B1.G120-1022.2	G1201022	24338	15,5	B1.G120-1224.2	G1201224	23707	18,0				
B1.G120-1025.2	G1201025	23993	15,5	B1.G120-1225.2	G1201225	23709	19,0				
B1.G120-1025.2	G1201025	23997	15,5	B1.G120-1225.2	G1201225	23710	19,0				
B1.G120-1025.2	G1201025	24058	15,5	B1.G120-1272.2	G1201272	23070	16,9				
B1.G120-1029.2	G1201029	23698	16,8	B1.G120-5203.2	G1205203	23561	18,1				
B1.G120-1029.2	G1201029	23699	16,8	B1.G120-5203.2	G1205203	23562	18,1				
B1.G120-1033.2	G1201033	24317	17,6	B1.G120-5215.2	G1205215	23532	20,1				
B1.G120-1033.2	G1201033	24318	17,6	B1.G120-5215.2	G1205215	23533	20,1				
B1.G120-1033.2	G1201033	24319	17,6	B1.G120-5215.2	G1205215	23534	20,1				
B1.G120-1035.2	G1201035	24320	15,3	B1.G120-5230.2	G1205230	23582	16,0				
B1.G120-1035.2	G1201035	24321	15,3	B1.G120-5230.2	G1205230	23583	16,0				
B1.G120-1035.2	G1201035	24322	15,3	B1.G120-5234.2	G1205234	24036	16,7				
B1.G120-1047.2	G1201047	24275	16,5	B1.G120-5234.2	G1205234	24037	16,7				
B1.G120-1047.2	G1201047	24410	16,5	B1.G120-5234.2	G1205234	24038	16,7				
B1.G120-1047.2	G1201047	24411	16,5	B1.G120-5238.2	G1205238	23638	18,3				
B1.G120-1053.2	G1201053	24283	15,5	B1.G120-5238.2	G1205238	23639	18,3				
B1.G120-1053.2	G1201053	24284	15,5	B1.G120-5241.2	G1205241	23584	16,4				
B1.G120-1053.2	G1201053	24285	15,5	B1.G120-5242.2	G1205242	23928	17,3				
B1.G120-1056.2	G1201056	21730	14,0	B1.G120-5333.2	G1205333	24024	17,0				
B1.G120-1056.2	G1201056	21730	14,9	B1.G120-5333.2	G1205333	24025	17,0				
B1.G120-1059.2	G1201059	23973	17,2	B1.G120-5333.2	G1205333	24026	17,0				
B1.G120-1059.2	G1201059	24403	17,2	B1.G120-5344.2	G1205344	23178	16,6				

# CROSS REFERENCE LIST

Liste des correspondances / Tabella di conversione codici / Lista de comparação

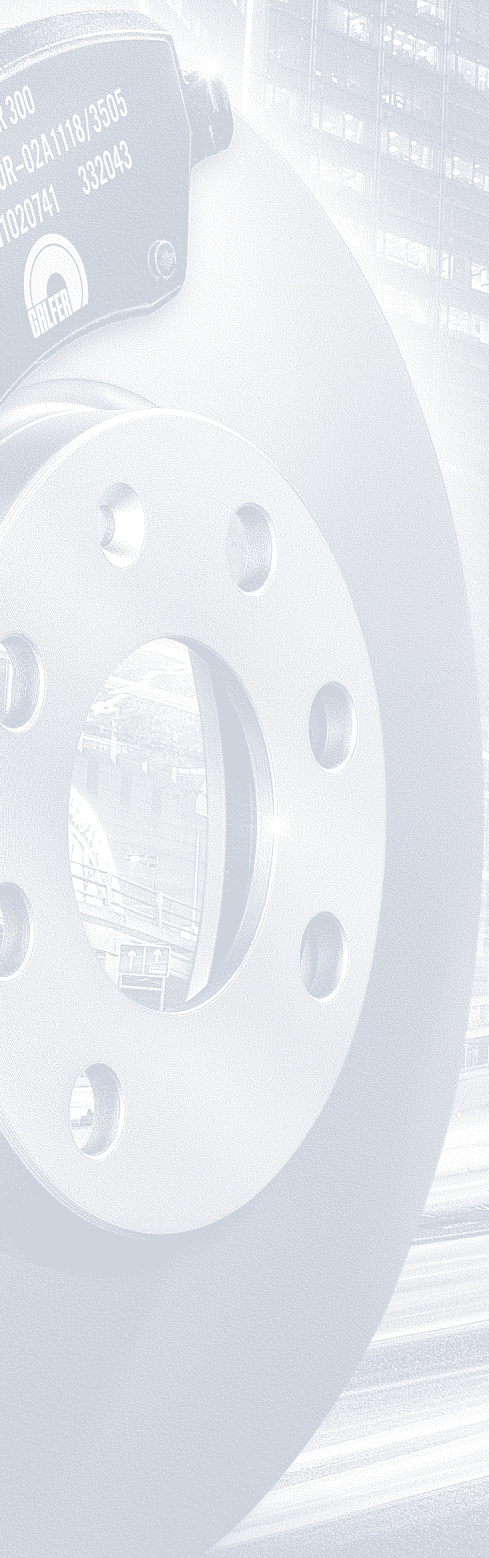

Lista porównawcza numerów / Porovnávací seznam čísel



# Cross reference list

Liste des correspondances / Tabella di conversione codici / Lista de comparação /

Lista porównawcza numerów / Porovnávací seznam čísel



ATE 	ATE 	ATE 
13.0460-2707.2 B1.G102-0572.2 G1020572	13.0460-2837.2 B1.G102-0511.2 G1020511	13.0460-2958.2 B1.G102-0274.2 G1020274
13.0460-2708.2 B1.G102-0829.2 G1020829	13.0460-2838.2 B1.G102-0524.2 G1020524	13.0460-2959.2 B1.G120-5215.2 G1205215
13.0460-2709.2 B1.G102-0741.2 G1020741	13.0460-2839.2 B1.G102-0533.2 G1020533	13.0460-2972.2 B1.G102-0304.2 G1020304
13.0460-2710.2 B1.G102-0794.2 G1020794	13.0460-2840.2 B1.G102-0529.2 G1020529	13.0460-2973.2 B1.G102-0315.2 G1020315
13.0460-2711.2 B1.G102-0855.2 G1020855	13.0460-2845.2 B1.G102-0489.2 G1020489	13.0460-2975.2 B1.G102-0337.2 G1020337
13.0460-2712.2 B1.G102-0852.2 G1020852	13.0460-2850.2 B1.G102-0482.2 G1020482	13.0460-2976.2 B1.G102-0301.2 G1020301
13.0460-2713.2 B1.G102-0844.2 G1020844	13.0460-2852.2 B1.G102-0483.2 G1020483	13.0460-2977.2 B1.G102-0302.2 G1020302
13.0460-2714.2 B1.G102-0796.2 G1020796	13.0460-2853.2 B1.G102-0537.2 G1020537	13.0460-2978.2 B1.G102-0310.2 G1020310
13.0460-2715.2 B1.G102-0774.2 G1020774	13.0460-2855.2 B1.G102-0544.2 G1020544	13.0460-2982.2 B1.G102-0347.2 G1020347
13.0460-2718.2 B1.G102-0901.2 G1020901	13.0460-2857.2 B1.G102-0545.2 G1020545	13.0460-2983.2 B1.G102-0326.2 G1020326
13.0460-2722.2 B1.G102-0787.2 G1020787	13.0460-2858.2 B1.G102-0560.2 G1020560	13.0460-2984.2 B1.G102-0345.2 G1020345
13.0460-2723.2 B1.G102-0786.2 G1020786	13.0460-2859.2 B1.G102-0564.2 G1020564	13.0460-3602.2 B1.G102-0246.2 G1020246
13.0460-2724.2 B1.G102-0896.2 G1020896	13.0460-2860.2 B1.G102-0559.2 G1020559	13.0460-3605.2 B1.G102-0316.2 G1020316
13.0460-2725.2 B1.G102-0856.2 G1020856	13.0460-2862.2 B1.G102-0570.2 G1020570	13.0460-3800.2 B1.G102-0624.2 G1020624
13.0460-2726.2 B1.G102-0924.2 G1020924	13.0460-2863.2 B1.G102-0514.2 G1020514	13.0460-3803.2 B1.G102-0308.2 G1020308
13.0460-2727.2 B1.G102-0925.2 G1020925	13.0460-2864.2 B1.G102-0549.2 G1020549	13.0460-3805.2 B1.G102-0339.2 G1020339
13.0460-2732.2 B1.G102-0933.2 G1020933	13.0460-2867.2 B1.G102-0568.2 G1020568	13.0460-3806.2 B1.G102-0627.2 G1020627
13.0460-2733.2 B1.G102-0934.2 G1020934	13.0460-2868.2 B1.G102-0610.2 G1020610	13.0460-3807.2 B1.G102-0621.2 G1020621
13.0460-2734.2 B1.G102-0935.2 G1020935	13.0460-2870.2 B1.G102-0633.2 G1020633	13.0460-3809.2 B1.G102-0613.2 G1020613
13.0460-2736.2 B1.G102-0900.2 G1020900	13.0460-2871.2 B1.G102-0686.2 G1020686	13.0460-3811.2 B1.G102-0614.2 G1020614
13.0460-2737.2 B1.G120-1135.2 G1201135	13.0460-2872.2 B1.G102-0654.2 G1020654	13.0460-3813.2 B1.G102-0630.2 G1020630
13.0460-2738.2 B1.G102-0937.2 G1020937	13.0460-2874.2 B1.G102-0658.2 G1020658	13.0460-3815.2 B1.G102-0685.2 G1020685
13.0460-2739.2 B1.G102-0938.2 G1020938	13.0460-2877.2 B1.G102-0566.2 G1020566	13.0460-3818.2 B1.G102-0740.2 G1020740
13.0460-2740.2 B1.G102-0920.2 G1020920	13.0460-2878.2 B1.G102-0573.2 G1020573	13.0460-3819.2 B1.G102-0751.2 G1020751
13.0460-2741.2 B1.G102-0875.2 G1020875	13.0460-2879.2 B1.G102-0567.2 G1020567	13.0460-3821.2 B1.G102-0752.2 G1020752
13.0460-2742.2 B1.G102-0876.2 G1020876	13.0460-2880.2 B1.G102-0682.2 G1020682	13.0460-3822.2 B1.G102-0777.2 G1020777
13.0460-2744.2 B1.G102-0874.2 G1020874	13.0460-2881.2 B1.G102-0687.2 G1020687	13.0460-3823.2 B1.G102-0522.2 G1020522
13.0460-2745.2 B1.G102-0921.2 G1020921	13.0460-2882.2 B1.G102-0691.2 G1020691	13.0460-3825.2 B1.G102-0672.2 G1020672
13.0460-2746.2 B1.G102-0983.2 G1020983	13.0460-2883.2 B1.G102-0732.2 G1020732	13.0460-3826.2 B1.G102-0737.2 G1020737
13.0460-2747.2 B1.G120-1004.2 G1201004	13.0460-2884.2 B1.G102-0733.2 G1020733	13.0460-3827.2 B1.G102-0738.2 G1020738
13.0460-2748.2 B1.G120-1005.2 G1201005	13.0460-2885.2 B1.G102-0661.2 G1020661	13.0460-3829.2 B1.G102-0830.2 G1020830
13.0460-2749.2 B1.G102-0993.2 G1020993	13.0460-2886.2 B1.G102-0676.2 G1020676	13.0460-3831.2 B1.G102-0625.2 G1020625
13.0460-2754.2 B1.G120-1147.2 G1201147	13.0460-2887.2 B1.G102-0734.2 G1020734	13.0460-3832.2 B1.G102-0766.2 G1020766
13.0460-2755.2 B1.G120-1149.2 G1201149	13.0460-2888.2 B1.G102-0758.2 G1020758	13.0460-3833.2 B1.G102-0800.2 G1020800
13.0460-2758.2 B1.G120-1148.2 G1201148	13.0460-2889.2 B1.G102-0759.2 G1020759	13.0460-3834.2 B1.G102-0801.2 G1020801
13.0460-2759.2 B1.G120-1213.2 G1201213	13.0460-2891.2 B1.G102-0761.2 G1020761	13.0460-3835.2 B1.G102-0802.2 G1020802
13.0460-2761.2 B1.G102-0946.2 G1020946	13.0460-2892.2 B1.G102-0762.2 G1020762	13.0460-3836.2 B1.G102-0799.2 G1020799
13.0460-2774.2 B1.G120-1059.2 G1201059	13.0460-2893.2 B1.G102-0660.2 G1020660	13.0460-3837.2 B1.G102-0922.2 G1020922
13.0460-2776.2 B1.G120-1272.2 G1201272	13.0460-2894.2 B1.G102-0755.2 G1020755	13.0460-3838.2 B1.G102-0951.2 G1020951
13.0460-2816.2 B1.G102-0362.2 G1020362	13.0460-2895.2 B1.G102-0569.2 G1020569	13.0460-3839.2 B1.G102-0858.2 G1020858
13.0460-2817.2 B1.G102-0363.2 G1020363	13.0460-2896.2 B1.G102-0779.2 G1020779	13.0460-3840.2 B1.G102-0833.2 G1020833
13.0460-2819.2 B1.G102-0549.2 G1020549	13.0460-2897.2 B1.G102-0780.2 G1020780	13.0460-3842.2 B1.G102-0940.2 G1020940
13.0460-2820.2 B1.G102-0492.2 G1020492	13.0460-2899.2 B1.G120-5238.2 G1205238	13.0460-3846.2 B1.G102-0952.2 G1020952
13.0460-2821.2 B1.G102-0444.2 G1020444	13.0460-2901.2 B1.G102-0147.2 G1020147	13.0460-3847.2 B1.G102-0859.2 G1020859
13.0460-2822.2 B1.G102-0421.2 G1020421	13.0460-2923.2 B1.G102-0257.2 G1020257	13.0460-3850.2 B1.G102-0987.2 G1020987
13.0460-2823.2 B1.G102-0492.2 G1020492	13.0460-2925.2 B1.G102-0197.2 G1020197	13.0460-3851.2 B1.G102-0995.2 G1020995
13.0460-2825.2 B1.G102-0299.2 G1020299	13.0460-2927.2 B1.G102-0044.2 G1020044	13.0460-3854.2 B1.G120-1209.2 G1201209
13.0460-2826.2 B1.G102-0384.2 G1020384	13.0460-2928.2 B1.G102-0028.2 G1020028	13.0460-3861.2 B1.G120-1128.2 G1201128
13.0460-2827.2 B1.G102-0359.2 G1020359	13.0460-2934.2 B1.G102-0196.2 G1020196	13.0460-3863.2 B1.G120-1224.2 G1201224
13.0460-2828.2 B1.G102-0615.2 G1020615	13.0460-2935.2 B1.G102-0955.2 G1020955	13.0460-3864.2 B1.G120-1225.2 G1201225
13.0460-2829.2 B1.G102-0451.2 G1020451	13.0460-2937.2 B1.G102-0201.2 G1020201	13.0460-3911.2 B1.G102-0214.2 G1020214
13.0460-2830.2 B1.G102-0457.2 G1020457	13.0460-2941.2 B1.G102-0140.2 G1020140	13.0460-3926.2 B1.G102-0522.2 G1020522
13.0460-2831.2 B1.G102-0458.2 G1020458	13.0460-2948.2 B1.G102-0184.2 G1020184	13.0460-3928.2 B1.G102-0065.2 G1020065
13.0460-2832.2 B1.G102-0459.2 G1020459	13.0460-2949.2 B1.G102-0140.2 G1020140	13.0460-3939.2 B1.G102-0141.2 G1020141
13.0460-2833.2 B1.G102-0440.2 G1020440	13.0460-2951.2 B1.G102-0236.2 G1020236	13.0460-3940.2 B1.G102-0141.2 G1020141
13.0460-2834.2 B1.G102-0501.2 G1020501	13.0460-2956.2 B1.G102-0213.2 G1020213	13.0460-3943.2 B1.G102-0296.2 G1020296
13.0460-2835.2 B1.G102-0507.2 G1020507	13.0460-2957.2 B1.G102-0273.2 G1020273	13.0460-3949.2 B1.G102-0259.2 G1020259



# Cross reference list

Liste des correspondances / Tabella di conversione codici / Lista de comparação /



Lista porównawcza numerów / Porovnávací seznam čísel

ATE 	ATE 	ATE 
13.0460-3950.2	B1.G102-0305.2 G1020305	13.0460-4827.2 B1.G102-0770.2 G1020770
13.0460-3951.2	B1.G102-0298.2 G1020298	13.0460-4830.2 B1.G102-0828.2 G1020828
13.0460-3952.2	B1.G102-0295.2 G1020295	13.0460-4833.2 B1.G120-1010.2 G1201010
13.0460-3953.2	B1.G102-0323.2 G1020323	13.0460-4834.2 B1.G120-1011.2 G1201011
13.0460-3954.2	B1.G102-0216.2 G1020216	13.0460-4840.2 B1.G120-1066.2 G1201066
13.0460-3955.2	B1.G102-0219.2 G1020219	13.0460-4850.2 B1.G102-0999.2 G1020999
13.0460-3956.2	B1.G102-0328.2 G1020328	13.0460-4852.2 B1.G120-1079.2 G1201079
13.0460-3957.2	B1.G102-0350.2 G1020350	13.0460-4856.2 B1.G102-0905.2 G1020905
13.0460-3959.2	B1.G102-0618.2 G1020618	13.0460-4858.2 B1.G102-0907.2 G1020907
13.0460-3960.2	B1.G102-0617.2 G1020617	13.0460-4921.2 B1.G102-0604.2 G1020604
13.0460-3962.2	B1.G102-0215.2 G1020215	13.0460-4956.2 B1.G102-0329.2 G1020329
13.0460-3963.2	B1.G102-0885.2 G1020885	13.0460-4957.2 B1.G102-0327.2 G1020327
13.0460-3964.2	B1.G102-0886.2 G1020886	13.0460-4965.2 B1.G102-0372.2 G1020372
13.0460-3965.2	B1.G102-0423.2 G1020423	13.0460-4966.2 B1.G102-0357.2 G1020357
13.0460-3966.2	B1.G102-0735.2 G1020735	13.0460-4976.2 B1.G102-0711.2 G1020711
13.0460-3976.2	B1.G102-0554.2 G1020554	13.0460-4977.2 B1.G102-0575.2 G1020575
13.0460-3977.2	B1.G102-0497.2 G1020497	13.0460-4978.2 B1.G102-0516.2 G1020516
13.0460-3978.2	B1.G102-0513.2 G1020513	13.0460-4979.2 B1.G102-0517.2 G1020517
13.0460-3979.2	B1.G102-0540.2 G1020540	13.0460-4980.2 B1.G102-0518.2 G1020518
13.0460-3980.2	B1.G102-0582.2 G1020582	13.0460-4984.2 B1.G102-0574.2 G1020574
13.0460-3982.2	B1.G102-0740.2 G1020740	13.0460-4987.2 B1.G102-0882.2 G1020882
13.0460-3983.2	B1.G102-0503.2 G1020503	13.0460-4988.2 B1.G102-0883.2 G1020883
13.0460-3984.2	B1.G102-0504.2 G1020504	13.0460-4990.2 B1.G102-0677.2 G1020677
13.0460-3985.2	B1.G102-0584.2 G1020584	13.0460-4992.2 B1.G102-0709.2 G1020709
13.0460-3987.2	B1.G102-0562.2 G1020562	13.0460-4993.2 B1.G102-0710.2 G1020710
13.0460-3988.2	B1.G102-0563.2 G1020563	13.0460-4994.2 B1.G102-0659.2 G1020659
13.0460-3990.2	B1.G102-0583.2 G1020583	13.0460-4999.2 B1.G102-0785.2 G1020785
13.0460-3991.2	B1.G102-0515.2 G1020515	13.0460-5405.2 B1.G102-0608.2 G1020608
13.0460-3992.2	B1.G102-0595.2 G1020595	13.0460-5602.2 B1.G102-0988.2 G1020988
13.0460-3993.2	B1.G102-0597.2 G1020597	13.0460-5604.2 B1.G102-0768.2 G1020768
13.0460-3995.2	B1.G102-0605.2 G1020605	13.0460-5609.2 B1.G120-1085.2 G1201085
13.0460-3997.2	B1.G102-0602.2 G1020602	13.0460-5611.2 B1.G120-1143.2 G1201143
13.0460-3998.2	B1.G102-0603.2 G1020603	13.0460-5612.2 B1.G120-1145.2 G1201145
13.0460-3999.2	B1.G102-0632.2 G1020632	13.0460-5700.2 B1.G120-1059.2 G1201059
13.0460-4028.2	B1.G102-0097.2 G1020097	13.0460-5714.2 B1.G102-0812.2 G1020812
13.0460-4030.2	B1.G102-0022.2 G1020022	13.0460-5731.2 B1.G120-1000.2 G1201000
13.0460-4034.2	B1.G102-0046.2 G1020046	13.0460-5742.2 B1.G120-1002.2 G1201002
13.0460-4040.2	B1.G102-0271.2 G1020271	13.0460-5743.2 B1.G120-5242.2 G1205242
13.0460-4041.2	B1.G102-0269.2 G1020269	13.0460-5744.2 B1.G120-5404.2 G1205404
13.0460-4042.2	B1.G102-0275.2 G1020275	13.0460-5747.2 B1.G120-5333.2 G1205333
13.0460-4043.2	B1.G102-0272.2 G1020272	13.0460-5752.2 B1.G102-0866.2 G1020866
13.0460-4044.2	B1.G102-0510.2 G1020510	13.0460-5753.2 B1.G102-0817.2 G1020817
13.0460-4047.2	B1.G102-0400.2 G1020400	13.0460-5754.2 B1.G102-0819.2 G1020819
13.0460-4058.2	B1.G102-0290.2 G1020290	13.0460-5755.2 B1.G120-5344.2 G1205344
13.0460-4059.2	B1.G102-0373.2 G1020373	13.0460-5756.2 B1.G120-1013.2 G1201013
13.0460-4060.2	B1.G102-0422.2 G1020422	13.0460-5757.2 B1.G120-1014.2 G1201014
13.0460-4064.2	B1.G102-0441.2 G1020441	13.0460-5760.2 B1.G120-5241.2 G1205241
13.0460-4065.2	B1.G102-0442.2 G1020442	13.0460-5763.2 B1.G120-1056.2 G1201056
13.0460-4066.2	B1.G102-0443.2 G1020443	13.0460-5765.2 B1.G120-1022.2 G1201022
13.0460-4807.2	B1.G102-0763.2 G1020763	13.0460-5766.2 B1.G102-0994.2 G1020994
13.0460-4809.2	B1.G102-0872.2 G1020872	13.0460-5767.2 B1.G120-1065.2 G1201065
13.0460-4810.2	B1.G102-0764.2 G1020764	13.0460-5768.2 B1.G102-0974.2 G1020974
13.0460-4811.2	B1.G102-0873.2 G1020873	13.0460-5769.2 B1.G102-0975.2 G1020975
13.0460-4812.2	B1.G102-0730.2 G1020730	13.0460-5773.2 B1.G120-1025.2 G1201025
13.0460-4817.2	B1.G102-0877.2 G1020877	13.0460-5776.2 B1.G120-1047.2 G1201047
13.0460-4823.2	B1.G102-0825.2 G1020825	13.0460-5778.2 B1.G120-1029.2 G1201029
13.0460-4826.2	B1.G102-0769.2 G1020769	13.0460-5779.2 B1.G120-1033.2 G1201033
		13.0460-5780.2 B1.G120-1035.2 G1201035
		13.0460-5785.2 B1.G102-0979.2 G1020979
		13.0460-5787.2 B1.G120-5418.2 G1205418
		13.0460-5788.2 B1.G102-0981.2 G1020981
		13.0460-5794.2 B1.G120-1053.2 G1201053
		13.0460-5800.2 B1.G102-0478.2 G1020478
		13.0460-5801.2 B1.G102-0538.2 G1020538
		13.0460-5804.2 B1.G102-0721.2 G1020721
		13.0460-5810.2 B1.G102-0714.2 G1020714
		13.0460-5813.2 B1.G102-0662.2 G1020662
		13.0460-5814.2 B1.G102-0663.2 G1020663
		13.0460-5815.2 B1.G102-0712.2 G1020712
		13.0460-5819.2 B1.G102-0713.2 G1020713
		13.0460-5820.2 B1.G102-0722.2 G1020722
		13.0460-5821.2 B1.G102-0719.2 G1020719
		13.0460-5855.2 B1.G120-5230.2 G1205230
		13.0460-6033.2 B1.G102-0474.2 G1020474
		13.0460-7030.2 B1.G102-0025.2 G1020025
		13.0460-7032.2 B1.G102-0009.2 G1020009
		13.0460-7033.2 B1.G102-0010.2 G1020010
		13.0460-7040.2 B1.G102-0026.2 G1020026
		13.0460-7048.2 B1.G102-0015.2 G1020015
		13.0460-7050.2 B1.G102-0311.2 G1020311
		13.0460-7051.2 B1.G102-0317.2 G1020317
		13.0460-7052.2 B1.G102-0258.2 G1020258
		13.0460-7053.2 B1.G102-0956.2 G1020956
		13.0460-7056.2 B1.G102-0265.2 G1020265
		13.0460-7057.2 B1.G102-0320.2 G1020320
		13.0460-7058.2 B1.G102-0292.2 G1020292
		13.0460-7059.2 B1.G102-0344.2 G1020344
		13.0460-7061.2 B1.G102-0291.2 G1020291
		13.0460-7064.2 B1.G102-0340.2 G1020340
		13.0460-7065.2 B1.G102-0342.2 G1020342
		13.0460-7069.2 B1.G102-0360.2 G1020360
		13.0460-7071.2 B1.G102-0334.2 G1020334
		13.0460-7072.2 B1.G102-0355.2 G1020355
		13.0460-7073.2 B1.G102-0332.2 G1020333
		13.0460-7076.2 B1.G102-0312.2 G1020312
		13.0460-7077.2 B1.G102-0312.2 G1020312
		13.0460-7078.2 B1.G102-0368.2 G1020368
		13.0460-7079.2 B1.G102-0367.2 G1020367
		13.0460-7080.2 B1.G102-0369.2 G1020369
		13.0460-7081.2 B1.G102-0379.2 G1020379
		13.0460-7083.2 B1.G102-0396.2 G1020396
		13.0460-7084.2 B1.G102-0397.2 G1020397
		13.0460-7085.2 B1.G102-0395.2 G1020395
		13.0460-7086.2 B1.G102-0398.2 G1020398
		13.0460-7087.2 B1.G102-0401.2 G1020401
		13.0460-7088.2 B1.G102-0293.2 G1020293
		13.0460-7089.2 B1.G102-0411.2 G1020411
		13.0460-7090.2 B1.G102-0415.2 G1020415
		13.0460-7091.2 B1.G102-0403.2 G1020403
		13.0460-7100.2 B1.G102-0408.2 G1020408
		13.0460-7101.2 B1.G102-0390.2 G1020390
		13.0460-7102.2 B1.G102-0419.2 G1020419
		13.0460-7105.2 B1.G102-0392.2 G1020392
		13.0460-7110.2 B1.G102-0313.2 G1020313

# Cross reference list

Liste des correspondances / Tabella di conversione codici / Lista de comparação /

Lista porównawcza numerów / Porovnávací seznam čísel



ATE		ATE		ATE	
13.0460-7111.2	B1.G102-0331.2 G1020331	13.0460-7200.2	B1.G102-0753.2 G1020753	24.0109-0124.1	B1.G209-0124.1 G2109124
13.0460-7113.2	B1.G102-0389.2 G1020389	13.0460-7201.2	B1.G102-0754.2 G1020754	24.0109-0133.1	B1.G209-0133.1 G2109133
13.0460-7114.2	B1.G102-0351.2 G1020351	13.0460-7202.2	B1.G102-0745.2 G1020745	24.0109-0136.1	B1.G209-0136.1 G2109136
13.0460-7115.2	B1.G102-0542.2 G1020542	13.0460-7203.2	B1.G102-0776.2 G1020776	24.0109-0137.1	B1.G209-0137.1 G2109137
13.0460-7116.2	B1.G102-0550.2 G1020550	13.0460-7204.2	B1.G102-0772.2 G1020772	24.0109-0139.1	B1.G209-0139.1 G2109139
13.0460-7117.2	B1.G102-0463.2 G1020463	13.0460-7207.2	B1.G120-5366.2 G1205366	24.0109-0142.1	B1.G209-0142.1 G2109142
13.0460-7121.2	B1.G102-0505.2 G1020505	13.0460-7210.2	B1.G102-0746.2 G1020746	24.0109-0157.1	B1.G209-0157.1 G2109157
13.0460-7122.2	B1.G102-0512.2 G1020512	13.0460-7211.2	B1.G102-0701.2 G1020701	24.0110-0111.1	B1.G210-0111.1 G2110111
13.0460-7123.2	B1.G102-0527.2 G1020527	13.0460-7212.2	B1.G102-0836.2 G1020836	24.0110-0115.1	B1.G210-0115.1 G2110115
13.0460-7124.2	B1.G102-0534.2 G1020534	13.0460-7213.2	B1.G102-0798.2 G1020798	24.0110-0151.1	B1.G210-0151.1 G2110151
13.0460-7125.2	B1.G102-0469.2 G1020469	13.0460-7214.2	B1.G102-0666.2 G1020666	24.0110-0178.1	B1.G210-0178.1 G2110178
13.0460-7126.2	B1.G102-0448.2 G1020448	13.0460-7215.2	B1.G102-0846.2 G1020846	24.0110-0187.1	B1.G210-0187.1 G2110187
13.0460-7128.2	B1.G102-0427.2 G1020427	13.0460-7216.2	B1.G102-0848.2 G1020848	24.0110-0190.1	B1.G210-0190.1 G2110190
13.0460-7133.2	B1.G102-0484.2 G1020484	13.0460-7217.2	B1.G102-0850.2 G1020850	24.0110-0196.1	B1.G210-0196.1 G2110196
13.0460-7134.2	B1.G102-0487.2 G1020487	13.0460-7218.2	B1.G102-0699.2 G1020699	24.0110-0201.1	B1.G210-0201.1 G2110201
13.0460-7135.2	B1.G102-0480.2 G1020480	13.0460-7219.2	B1.G102-0862.2 G1020862	24.0110-0202.1	B1.G210-0202.1 G2110202
13.0460-7137.2	B1.G102-0470.2 G1020470	13.0460-7220.2	B1.G102-0860.2 G1020860	24.0110-0209.1	B1.G210-0209.1 G2110209
13.0460-7139.2	B1.G102-0500.2 G1020500	13.0460-7221.2	B1.G102-0871.2 G1020871	24.0110-0210.1	B1.G210-0210.1 G2110210
13.0460-7140.2	B1.G102-0473.2 G1020473	13.0460-7222.2	B1.G102-0867.2 G1020867	24.0110-0211.1	B1.G210-0211.1 G2110211
13.0460-7141.2	B1.G102-0496.2 G1020496	13.0460-7225.2	B1.G102-0887.2 G1020887	24.0110-0212.1	B1.G210-0212.1 G2110212
13.0460-7142.2	B1.G102-0519.2 G1020519	13.0460-7227.2	B1.G102-0895.2 G1020895	24.0110-0213.1	B1.G210-0213.1 G2110213
13.0460-7143.2	B1.G102-0557.2 G1020557	13.0460-7228.2	B1.G102-0889.2 G1020889	24.0110-0215.1	B1.G210-0215.1 G2110215
13.0460-7145.2	B1.G102-0578.2 G1020578	13.0460-7229.2	B1.G102-0790.2 G1020790	24.0110-0217.1	B1.G210-0217.1 G2110217
13.0460-7148.2	B1.G102-0467.2 G1020467	13.0460-7230.2	B1.G102-0792.2 G1020792	24.0110-0223.1	B1.G210-0223.1 G2110223
13.0460-7153.2	B1.G102-0580.2 G1020580	13.0460-7231.2	B1.G102-0806.2 G1020806	24.0110-0225.1	B1.G210-0225.1 G2110225
13.0460-7154.2	B1.G102-0593.2 G1020593	13.0460-7232.2	B1.G102-0803.2 G1020803	24.0110-0229.1	B1.G210-0229.1 G2110229
13.0460-7155.2	B1.G102-0591.2 G1020591	13.0460-7234.2	B1.G120-5352.2 G1205352	24.0110-0230.1	B1.G210-0230.1 G2110230
13.0460-7157.2	B1.G102-0576.2 G1020576	13.0460-7236.2	B1.G102-0707.2 G1020707	24.0110-0232.1	B1.G210-0232.1 G2110232
13.0460-7158.2	B1.G102-0547.2 G1020547	13.0460-7237.2	B1.G102-0971.2 G1020971	24.0110-0250.1	B1.G210-0250.1 G2110250
13.0460-7159.2	B1.G102-0548.2 G1020548	13.0460-7238.2	B1.G102-0939.2 G1020939	24.0110-0251.1	B1.G210-0251.1 G2110251
13.0460-7160.2	B1.G102-0470.2 G1020470	13.0460-7240.2	B1.G102-0706.2 G1020706	24.0110-0258.1	B1.G210-0258.1 G2110258
13.0460-7161.2	B1.G102-0646.2 G1020646	13.0460-7242.2	B1.G102-0992.2 G1020992	24.0110-0261.1	B1.G210-0261.1 G2110261
13.0460-7162.2	B1.G102-0648.2 G1020648	13.0460-7243.2	B1.G120-1009.2 G1201009	24.0110-0271.1	B1.G210-0271.1 G2110271
13.0460-7164.2	B1.G102-0409.2 G1020409	13.0460-7244.2	B1.G102-0963.2 G1020963	24.0110-0277.1	B1.G210-0277.1 G2110277
13.0460-7166.2	B1.G102-0644.2 G1020644	13.0460-7249.2	B1.G102-0834.2 G1020834	24.0110-0278.1	B1.G210-0278.1 G2110278
13.0460-7167.2	B1.G102-0634.2 G1020634	13.0460-7252.2	B1.G102-0893.2 G1020893	24.0110-0285.1	B1.G210-0285.1 G2110285
13.0460-7168.2	B1.G102-0637.2 G1020637	13.0460-7256.2	B1.G102-0823.2 G1020823	24.0110-0302.1	B1.G210-0302.1 G2110302
13.0460-7169.2	B1.G102-0638.2 G1020638	13.0460-7259.2	B1.G102-0985.2 G1020985	24.0110-0312.1	B1.G210-0312.1 G2110312
13.0460-7171.2	B1.G102-0652.2 G1020652	13.0460-7263.2	B1.G102-0928.2 G1020928	24.0110-0324.1	B1.G210-0324.1 G2110324
13.0460-7172.2	B1.G102-0650.2 G1020650	13.0460-7264.2	B1.G102-0953.2 G1020953	24.0110-0356.1	B1.G210-0356.1 G2110356
13.0460-7173.2	B1.G102-0642.2 G1020642	13.0460-7266.2	B1.G120-1126.2 G1201126	24.0111-0145.1	B1.G211-0145.1 G2111145
13.0460-7174.2	B1.G102-0588.2 G1020588	13.0460-7276.2	B1.G120-1070.2 G1201070	24.0111-0152.1	B1.G211-0152.1 G2111152
13.0460-7176.2	B1.G102-0586.2 G1020586	13.0460-7277.2	B1.G120-1073.2 G1201073	24.0111-0154.1	B1.G211-0154.1 G2111154
13.0460-7179.2	B1.G102-0765.2 G1020765	13.0460-7278.2	B1.G120-1069.2 G1201069	24.0111-0155.1	B1.G211-0155.1 G2111155
13.0460-7182.2	B1.G102-0678.2 G1020678	13.0460-7909.2	B1.G102-0891.2 G1020891	24.0111-0158.1	B1.G211-0158.1 G2111158
13.0460-7183.2	B1.G102-0683.2 G1020683	13.0460-8008.2	B1.G120-5234.2 G1205234	24.0111-0164.1	B1.G211-0164.1 G2111164
13.0460-7184.2	B1.G102-0680.2 G1020680	13.0460-8010.2	B1.G120-5203.2 G1205203	24.0112-0106.1	B1.G212-0106.1 G2112106
13.0460-7186.2	B1.G102-0692.2 G1020692	24.0107-0109.1	B1.G207-0109.1 G2107109	24.0112-0116.1	B1.G212-0116.1 G2112116
13.0460-7187.2	B1.G102-0694.2 G1020694	24.0108-0104.1	B1.G208-0104.1 G2108104	24.0112-0126.1	B1.G212-0126.1 G2112126
13.0460-7188.2	B1.G102-0696.2 G1020696	24.0108-0106.1	B1.G208-0106.1 G2108106	24.0112-0127.1	B1.G212-0127.1 G2112127
13.0460-7190.2	B1.G102-0698.2 G1020698	24.0108-0107.1	B1.G208-0107.1 G2108107	24.0112-0131.1	B1.G212-0131.1 G2112131
13.0460-7191.2	B1.G102-0704.2 G1020704	24.0108-0108.1	B1.G208-0108.1 G2108108	24.0112-0137.1	B1.G212-0137.1 G2112137
13.0460-7193.2	B1.G102-0622.2 G1020622	24.0108-0109.1	B1.G208-0109.1 G2108109	24.0112-0138.1	B1.G212-0138.1 G2112138
13.0460-7194.2	B1.G102-0670.2 G1020670	24.0108-0113.1	B1.G208-0113.1 G2108113	24.0112-0141.1	B1.G212-0141.1 G2112141
13.0460-7195.2	B1.G102-0727.2 G1020727	24.0109-0114.1	B1.G209-0114.1 G2109114	24.0112-0144.1	B1.G212-0144.1 G2112144
13.0460-7196.2	B1.G102-0742.2 G1020742	24.0109-0120.1	B1.G209-0120.1 G2109120	24.0112-0154.1	B1.G212-0154.1 G2112154
13.0460-7199.2	B1.G102-0756.2 G1020756	24.0109-0123.1	B1.G209-0123.1 G2109123	24.0112-0155.1	B1.G212-0155.1 G2112155



# Cross reference list

Liste des correspondances / Tabella di conversione codici / Lista de comparação /



Lista porównawcza numerów / Porovnávací seznam čísel

ATE		ATE		ATE	
24.0112-0157.1	B1.G212-0157.1 G2112157	24.0122-0204.1	B1.G222-0204.1 G2122204	24.0128-0132.1	B1.G228-0132.1 G2128132
24.0112-0158.1	B1.G212-0158.1 G2112158	24.0122-0210.1	B1.G222-0210.1 G2122210	24.0128-0142.1	B1.G228-0142.1 G2128142
24.0112-0162.1	B1.G212-0162.1 G2112162	24.0122-0211.1	B1.G222-0211.1 G2122211	24.0128-0154.1	B1.G228-0154.1 G2128154
24.0112-0169.1	B1.G212-0169.1 G2112169	24.0122-0216.1	B1.G222-0216.1 G2122216	24.0128-0164.1	B1.G228-0164.1 G2128164
24.0112-0171.1	B1.G212-0171.1 G2112171	24.0122-0231.1	B1.G222-0231.1 G2122231	24.0128-0176.1	B1.G228-0176.1 G2128176
24.0112-0178.1	B1.G212-0178.1 G2112178	24.0122-0232.1	B1.G222-0232.1 G2122232	24.0128-0177.1	B1.G228-0177.1 G2128177
24.0112-0184.1	B1.G212-0184.1 G2112184	24.0122-0238.1	B1.G222-0238.1 G2122238	24.0128-0203.1	B1.G228-0203.1 G2128203
24.0113-0161.1	B1.G213-0161.1 G2113161	24.0122-0240.1	B1.G222-0240.1 G2122240	24.0130-0113.1	B1.G230-0113.1 G2130113
24.0113-0178.1	B1.G213-0178.1 G2113178	24.0122-0258.1	B1.G222-0258.1 G2122258	24.0130-0114.1	B1.G230-0114.1 G2130114
24.0113-0181.1	B1.G213-0181.1 G2113181	24.0122-0270.1	B1.G222-0270.1 G2122270	24.0130-0115.1	B1.G230-0115.1 G2130115
24.0113-0182.1	B1.G213-0182.1 G2113182	24.0123-0113.1	B1.G223-0113.1 G2123113	24.0130-0175.1	B1.G230-0175.1 G2130175
24.0113-0184.1	B1.G213-0184.1 G2113184	24.0124-0115.1	B1.G224-0115.1 G2124115	24.0130-0176.1	B1.G230-0176.1 G2130176
24.0113-0185.1	B1.G213-0185.1 G2113185	24.0124-0120.1	B1.G224-0120.1 G2124120	24.0132-0114.1	B1.G232-0114.1 G2132114
24.0113-0195.1	B1.G213-0195.1 G2113195	24.0124-0127.1	B1.G224-0127.1 G2124127	24.0132-0115.1	B1.G232-0115.1 G2132115
24.0115-0105.1	B1.G215-0105.1 G2115105	24.0124-0131.1	B1.G224-0131.1 G2124131	24.0132-0144.1	B1.G232-0144.1 G2132144
24.0116-0123.1	B1.G216-0123.1 G2116123	24.0124-0138.1	B1.G224-0138.1 G2124138	24.0132-0153.1	B1.G232-0153.1 G2132153
24.0116-0124.1	B1.G216-0124.1 G2116124	24.0124-0152.1	B1.G224-0152.1 G2124152	24.0134-0100.1	B1.G234-0100.1 G2134100
24.0118-0106.1	B1.G218-0106.1 G2118106	24.0124-0158.1	B1.G224-0158.1 G2124158	<b>BENDIX</b>	
24.0118-0131.1	B1.G218-0131.1 G2118131	24.0124-0161.1	B1.G224-0161.1 G2124161	561087B	B1.G210-0151.1 G2110151
24.0118-0137.1	B1.G218-0137.1 G2118137	24.0124-0166.1	B1.G224-0166.1 G2124166	561141B	B1.G212-0106.1 G2112106
24.0118-0145.1	B1.G218-0145.1 G2118145	24.0124-0169.1	B1.G224-0169.1 G2124169	561158B	B1.G213-0161.1 G2113161
24.0119-0107.1	B1.G219-0107.1 G2119107	24.0124-0171.1	B1.G224-0171.1 G2124171	561178B	B1.G220-0123.1 G2120123
24.0119-0108.1	B1.G219-0108.1 G2119108	24.0124-0191.1	B1.G224-0191.1 G2124191	561235B	B1.G212-0116.1 G2112116
24.0120-0115.1	B1.G220-0115.1 G2120115	24.0124-0197.1	B1.G224-0197.1 G2124197	561248B	B1.G220-0115.1 G2120115
24.0120-0123.1	B1.G220-0123.1 G2120123	24.0124-0221.1	B1.G224-0221.1 G2124221	561253B	B1.G210-0187.1 G2110187
24.0120-0125.1	B1.G220-0125.1 G2120125	24.0124-0222.1	B1.G224-0222.1 G2124222	561257B	B1.G208-0104.1 G2108104
24.0120-0128.1	B1.G220-0128.1 G2120128	24.0125-0105.1	B1.G225-0105.1 G2125105	561312B	B1.G210-0178.1 G2110178
24.0120-0132.1	B1.G220-0132.1 G2120132	24.0125-0110.1	B1.G225-0110.1 G2125110	561329B	B1.G210-0190.1 G2110190
24.0120-0133.1	B1.G220-0133.1 G2120133	24.0125-0113.1	B1.G225-0113.1 G2125113	561333B	B1.G209-0120.1 G2109120
24.0120-0140.1	B1.G220-0140.1 G2120140	24.0125-0114.1	B1.G225-0114.1 G2125114	561336B	B1.G220-0125.1 G2120125
24.0120-0142.1	B1.G220-0142.1 G2120142	24.0125-0115.1	B1.G225-0115.1 G2125115	561340B	B1.G210-0209.1 G2110209
24.0120-0146.1	B1.G220-0146.1 G2120146	24.0125-0117.1	B1.G225-0117.1 G2125117	561359B	B1.G208-0107.1 G2108107
24.0120-0147.1	B1.G220-0147.1 G2120147	24.0125-0119.1	B1.G225-0119.1 G2125119	561364B	B1.G220-0133.1 G2120133
24.0120-0155.1	B1.G220-0155.1 G2120155	24.0125-0123.1	B1.G225-0123.1 G2125123	561375B	B1.G210-0115.1 G2110115
24.0120-0174.1	B1.G220-0174.1 G2120174	24.0125-0124.1	B1.G225-0124.1 G2125124	561383B	B1.G210-0212.1 G2110212
24.0120-0175.1	B1.G220-0175.1 G2120175	24.0125-0131.1	B1.G225-0131.1 G2125131	561387B	B1.G222-0147.1 G2122147
24.0120-0180.1	B1.G220-0180.1 G2120180	24.0125-0137.1	B1.G225-0137.1 G2125137	561403B	B1.G212-0184.1 G2112184
24.0120-0184.1	B1.G220-0184.1 G2120184	24.0125-0138.1	B1.G225-0138.1 G2125138	561409B	B1.G220-0132.1 G2120132
24.0120-0195.1	B1.G220-0195.1 G2120195	24.0125-0141.1	B1.G225-0141.1 G2125141	561448B	B1.G220-0128.1 G2120128
24.0120-0204.1	B1.G220-0204.1 G2120204	24.0125-0142.1	B1.G225-0142.1 G2125142	561460B	B1.G210-0111.1 G2110111
24.0120-0211.1	B1.G220-0211.1 G2120211	24.0125-0145.1	B1.G225-0145.1 G2125145	561468B	B1.G220-0142.1 G2120142
24.0121-0105.1	B1.G221-0105.1 G2121105	24.0125-0148.1	B1.G225-0148.1 G2125148	561469B	B1.G212-0127.1 G2112127
24.0121-0106.1	B1.G221-0106.1 G2121106	24.0125-0149.1	B1.G225-0149.1 G2125149	561488B	B1.G224-0115.1 G2124115
24.0122-0115.1	B1.G222-0115.1 G2122115	24.0125-0155.1	B1.G225-0155.1 G2125155	561491B	B1.G213-0178.1 G2113178
24.0122-0145.1	B1.G222-0145.1 G2122145	24.0125-0158.1	B1.G225-0158.1 G2125158	561496B	B1.G210-0196.1 G2110196
24.0122-0147.1	B1.G222-0147.1 G2122147	24.0125-0162.1	B1.G225-0162.1 G2125162	561513B	B1.G220-0147.1 G2120147
24.0122-0148.1	B1.G222-0148.1 G2122148	24.0125-0165.1	B1.G225-0165.1 G2125165	561520B	B1.G222-0145.1 G2122145
24.0122-0150.1	B1.G222-0150.1 G2122150	24.0125-0170.1	B1.G225-0170.1 G2125170	561547B	B1.G215-0105.1 G2115105
24.0122-0151.1	B1.G222-0151.1 G2122151	24.0125-0171.1	B1.G225-0171.1 G2125171	561548B	B1.G225-0105.1 G2125105
24.0122-0152.1	B1.G222-0152.1 G2122152	24.0125-0184.1	B1.G225-0184.1 G2125184	561548B	B1.G225-0171.1 G2125171
24.0122-0159.1	B1.G222-0159.1 G2122159	24.0125-0198.1	B1.G225-0198.1 G2125198	561549B	B1.G210-0201.1 G2110201
24.0122-0160.1	B1.G222-0160.1 G2122160	24.0125-0199.1	B1.G225-0199.1 G2125199	561550B	B1.G212-0126.1 G2112126
24.0122-0161.1	B1.G222-0161.1 G2122161	24.0126-0106.1	B1.G226-0106.1 G2126106	561551B	B1.G222-0115.1 G2122115
24.0122-0163.1	B1.G222-0163.1 G2122163	24.0126-0120.1	B1.G226-0120.1 G2126120	561552B	B1.G210-0202.1 G2110202
24.0122-0172.1	B1.G222-0172.1 G2122172	24.0126-0150.1	B1.G226-0150.1 G2126150	561555B	B1.G208-0106.1 G2108106
24.0122-0194.1	B1.G222-0194.1 G2122194	24.0126-0154.1	B1.G226-0154.1 G2126154	561588B	B1.G220-0140.1 G2120140
24.0122-0197.1	B1.G222-0197.1 G2122197	24.0128-0125.1	B1.G228-0125.1 G2128125		

# Cross reference list

Liste des correspondances / Tabella di conversione codici / Lista de comparação /



Lista porównawcza numerów / Porovnávací seznam čísel

BENDIX 	BENDIX 	BENDIX 
561590B	B1.G221-0106.1 G2121106	562073B B1.G213-0182.1 G2113182
561591B	B1.G208-0108.1 G2108108	562078B B1.G222-0172.1 G2122172
561592B	B1.G222-0148.1 G2122148	562081B B1.G212-0138.1 G2112138
561593B	B1.G224-0171.1 G2124171	562086B B1.G222-0161.1 G2122161
561615B	B1.G210-0215.1 G2110215	562089B B1.G210-0258.1 G2110258
561624B	B1.G224-0131.1 G2124131	562090B B1.G222-0160.1 G2122160
561630B	B1.G221-0105.1 G2121105	562094B B1.G219-0108.1 G2119108
561663B	B1.G212-0137.1 G2112137	562101B B1.G232-0115.1 G2132115
561678B	B1.G224-0120.1 G2124120	562103B B1.G224-0158.1 G2124158
561679B	B1.G220-0146.1 G2120146	562104B B1.G224-0171.1 G2124171
561698B	B1.G209-0120.1 G2109120	562120B B1.G222-0161.1 G2122161
561709B	B1.G210-0213.1 G2110213	562128B B1.G222-0194.1 G2122194
561733B	B1.G208-0108.1 G2108108	562129B B1.G226-0120.1 G2126120
561822B	B1.G225-0124.1 G2125124	562130B B1.G209-0137.1 G2109137
561861B	B1.G220-0142.1 G2120142	562132B B1.G225-0123.1 G2125123
561863B	B1.G210-0261.1 G2110261	562133B B1.G222-0163.1 G2122163
561868B	B1.G208-0109.1 G2108109	562138B B1.G213-0195.1 G2113195
561870B	B1.G212-0131.1 G2112131	562139B B1.G222-0204.1 G2122204
561960B	B1.G225-0119.1 G2125119	562155B B1.G209-0136.1 G2109136
561961B	B1.G210-0225.1 G2110225	562164B B1.G212-0155.1 G2112155
561963B	B1.G209-0114.1 G2109114	562169B B1.G218-0131.1 G2118131
561965B	B1.G222-0161.1 G2122161	562171B B1.G209-0124.1 G2109124
561969B	B1.G224-0138.1 G2124138	562177B B1.G209-0133.1 G2109133
561979B	B1.G213-0181.1 G2113181	562178B B1.G222-0197.1 G2122197
561980B	B1.G210-0232.1 G2110232	562180B B1.G224-0161.1 G2124161
561981B	B1.G218-0106.1 G2118106	562182B B1.G224-0169.1 G2124169
561982B	B1.G210-0210.1 G2110210	562188B B1.G225-0138.1 G2125138
561984B	B1.G224-0127.1 G2124127	562192B B1.G210-0261.1 G2110261
561997B	B1.G221-0106.1 G2121106	562193B B1.G212-0154.1 G2112154
562003B	B1.G219-0107.1 G2119107	562194B B1.G210-0271.1 G2110271
562006B	B1.G212-0127.1 G2112127	562195B B1.G211-0152.1 G2111152
562007B	B1.G210-0211.1 G2110211	562196B B1.G224-0166.1 G2124166
562013B	B1.G225-0110.1 G2125110	562199B B1.G225-0137.1 G2125137
562014B	B1.G210-0217.1 G2110217	562202B B1.G228-0125.1 G2128125
562019B	B1.G226-0106.1 G2126106	562205B B1.G230-0113.1 G2130113
562032B	B1.G210-0215.1 G2110215	562212B B1.G228-0176.1 G2128176
562033B	B1.G220-0155.1 G2120155	562213B B1.G210-0278.1 G2110278
562035B	B1.G222-0159.1 G2122159	562215B B1.G216-0124.1 G2116124
562038B	B1.G212-0141.1 G2112141	562216B B1.G225-0141.1 G2125141
562039B	B1.G222-0150.1 G2122150	562229B B1.G212-0157.1 G2112157
562040B	B1.G222-0151.1 G2122151	562234B B1.G230-0114.1 G2130114
562041B	B1.G225-0113.1 G2125113	562235B B1.G225-0145.1 G2125145
562042B	B1.G210-0230.1 G2110230	562236B B1.G210-0277.1 G2110277
562043B	B1.G225-0114.1 G2125114	562237B B1.G222-0210.1 G2122210
562044B	B1.G213-0184.1 G2113184	562238B B1.G212-0158.1 G2112158
562045B	B1.G220-0133.1 G2120133	562239B B1.G230-0115.1 G2130115
562048B	B1.G212-0144.1 G2112144	562240B B1.G225-0142.1 G2125142
562052B	B1.G225-0115.1 G2125115	562241B B1.G228-0132.1 G2128132
562053B	B1.G209-0123.1 G2109123	562243B B1.G228-0142.1 G2128142
562055B	B1.G213-0185.1 G2113185	562243B B1.G232-0144.1 G2132144
562057B	B1.G210-0223.1 G2110223	562253B B1.G212-0162.1 G2112162
562059B	B1.G210-0229.1 G2110229	562258B B1.G212-0169.1 G2112169
562060B	B1.G222-0152.1 G2122152	562261B B1.G209-0139.1 G2109139
562069B	B1.G224-0152.1 G2124152	562262B B1.G222-0211.1 G2122211
562070B	B1.G225-0131.1 G2125131	562264B B1.G210-0285.1 G2110285
562071B	B1.G210-0251.1 G2110251	562265B B1.G230-0175.1 G2130175
562072B	B1.G210-0250.1 G2110250	562268B B1.G222-0216.1 G2122216
		562270B B1.G211-0154.1 G2111154
		562271B B1.G225-0149.1 G2125149
		562274B B1.G208-0113.1 G2108113
		562277B B1.G225-0158.1 G2125158
		562278B B1.G225-0148.1 G2125148
		562287B B1.G225-0124.1 G2125124
		562290B B1.G220-0174.1 G2120174
		562293B B1.G212-0171.1 G2112171
		562294B B1.G228-0164.1 G2128164
		562296B B1.G220-0184.1 G2120184
		562304B B1.G212-0184.1 G2112184
		562305B B1.G222-0231.1 G2122231
		562309B B1.G218-0137.1 G2118137
		562311B B1.G220-0180.1 G2120180
		562312B B1.G222-0232.1 G2122232
		562315B B1.G225-0198.1 G2125198
		562316B B1.G220-0195.1 G2120195
		562317B B1.G222-0238.1 G2122238
		562341B B1.G232-0114.1 G2132114
		562354B B1.G228-0177.1 G2128177
		562361B B1.G211-0155.1 G2111155
		562363B B1.G225-0162.1 G2125162
		562363B B1.G228-0154.1 G2128154
		562364B B1.G225-0117.1 G2125117
		562402B B1.G232-0114.1 G2132114
		562409B B1.G220-0175.1 G2120175
		562410B B1.G224-0191.1 G2124191
		562411B B1.G211-0158.1 G2111158
		562414B B1.G225-0155.1 G2125155
		562416B B1.G210-0302.1 G2110302
		562420B B1.G207-0109.1 G2107109
		562421B B1.G222-0240.1 G2122240
		562422B B1.G209-0142.1 G2109142
		562428B B1.G218-0145.1 G2118145
		562429B B1.G210-0324.1 G2110324
		562434B B1.G225-0162.1 G2125162
		562442B B1.G220-0204.1 G2120204
		562456B B1.G220-0211.1 G2120211
		562466B B1.G225-0184.1 G2125184
		562485B B1.G228-0203.1 G2128203
		562505BC B1.G212-0178.1 G2112178
		562506BC B1.G230-0176.1 G2130176
		562517BC B1.G234-0100.1 G2134100
		562529BC B1.G224-0221.1 G2124221
		562536BC B1.G211-0145.1 G2111145
		562539BC B1.G223-0113.1 G2123113
		562551BC B1.G210-0312.1 G2110312
		562560BC B1.G211-0164.1 G2111164
		562576BC B1.G209-0157.1 G2109157
		562578BC B1.G226-0154.1 G2126154
		567760B B1.G222-0161.1 G2122161
		569122B B1.G222-0161.1 G2122161
		571205B B1.G102-0981.2 G1020981
		571221B B1.G102-0097.2 G1020097
		571221X B1.G102-0097.2 G1020097
		571224B B1.G102-0065.2 G1020065
		571276B B1.G102-0015.2 G1020015

# Cross reference list

Liste des correspondances / Tabella di conversione codici / Lista de comparação /



Lista porównawcza numerów / Porovnávací seznam čísel

BENDIX		BENDIX		BENDIX				
571276B-AS	B1.G102-0015.2	G1020015	571357B	B1.G102-0274.2	G1020274	571509X	B1.G102-0292.2	G1020292
571276X	B1.G102-0015.2	G1020015	571357B-AS	B1.G102-0274.2	G1020274	571512B	B1.G102-0311.2	G1020311
571297B	B1.G102-0141.2	G1020141	571357X	B1.G102-0196.2	G1020196	571522B	B1.G102-0265.2	G1020265
571297X	B1.G102-0141.2	G1020141	571357X	B1.G102-0274.2	G1020274	571522X	B1.G102-0265.2	G1020265
571301B	B1.G102-0140.2	G1020140	571361B	B1.G102-0201.2	G1020201	571523B	B1.G102-0298.2	G1020298
571304B	B1.G102-0147.2	G1020147	571361B	B1.G102-0559.2	G1020559	571524B	B1.G102-0296.2	G1020296
571309B	B1.G102-0140.2	G1020140	571361B	B1.G102-0676.2	G1020676	571524X	B1.G102-0296.2	G1020296
571309X	B1.G102-0140.2	G1020140	571361B-AS	B1.G102-0201.2	G1020201	571525B	B1.G102-0295.2	G1020295
571313B	B1.G102-0326.2	G1020326	571361X	B1.G102-0201.2	G1020201	571525B-AS	B1.G102-0295.2	G1020295
571315B	B1.G102-0025.2	G1020025	571361X	B1.G102-0559.2	G1020559	571525X	B1.G102-0295.2	G1020295
571315B-AS	B1.G102-0025.2	G1020025	571361X	B1.G102-0676.2	G1020676	571526B	B1.G102-0501.2	G1020501
571315X	B1.G102-0025.2	G1020025	571363B	B1.G102-0329.2	G1020329	571526X	B1.G102-0501.2	G1020501
571316B	B1.G102-0010.2	G1020010	571367B	B1.G102-0269.2	G1020269	571527B	B1.G102-0316.2	G1020316
571316B-AS	B1.G102-0010.2	G1020010	571367B-AS	B1.G102-0269.2	G1020269	571528B	B1.G102-0305.2	G1020305
571316X	B1.G102-0010.2	G1020010	571367X	B1.G102-0269.2	G1020269	571530B	B1.G102-0369.2	G1020369
571317B	B1.G102-0009.2	G1020009	571376B	B1.G102-0273.2	G1020273	571530B-AS	B1.G102-0369.2	G1020369
571317B-AS	B1.G102-0009.2	G1020009	571376B-AS	B1.G102-0273.2	G1020273	571534B	B1.G102-0196.2	G1020196
571317X	B1.G102-0009.2	G1020009	571376X	B1.G102-0273.2	G1020273	571536B	B1.G102-0334.2	G1020334
571319B	B1.G102-0299.2	G1020299	571382B	B1.G102-0044.2	G1020044	571536X	B1.G102-0334.2	G1020334
571319X	B1.G102-0213.2	G1020213	571382B-AS	B1.G102-0044.2	G1020044	571539B	B1.G102-0015.2	G1020015
571319X	B1.G102-0299.2	G1020299	571382X	B1.G102-0044.2	G1020044	571539B-AS	B1.G102-0015.2	G1020015
571320B	B1.G102-0213.2	G1020213	571387B	B1.G102-0308.2	G1020308	571545B	B1.G102-0308.2	G1020308
571320X	B1.G102-0213.2	G1020213	571387B-AS	B1.G102-0308.2	G1020308	571546B	B1.G102-0308.2	G1020308
571327B-AS	B1.G102-0501.2	G1020501	571388B	B1.G102-0339.2	G1020339	571546B-AS	B1.G102-0308.2	G1020308
571330B	B1.G102-0184.2	G1020184	571389B	B1.G102-0271.2	G1020271	571555B	B1.G102-0046.2	G1020046
571330X	B1.G102-0184.2	G1020184	571391B	B1.G102-0258.2	G1020258	571555B-AS	B1.G102-0046.2	G1020046
571331B	B1.G102-0219.2	G1020219	571391B-AS	B1.G102-0258.2	G1020258	571559B	B1.G102-0257.2	G1020257
571331B	B1.G102-0323.2	G1020323	571391X	B1.G102-0258.2	G1020258	571560B	B1.G102-0044.2	G1020044
571331X	B1.G102-0219.2	G1020219	571395B	B1.G102-0291.2	G1020291	571560B-AS	B1.G102-0044.2	G1020044
571331X	B1.G102-0323.2	G1020323	571395B-AS	B1.G102-0291.2	G1020291	571722B	B1.G102-0400.2	G1020400
571332B	B1.G102-0214.2	G1020214	571398B	B1.G102-0373.2	G1020373	571722B-AS	B1.G102-0400.2	G1020400
571332X	B1.G102-0214.2	G1020214	571406B	B1.G102-0299.2	G1020299	571725B	B1.G102-0423.2	G1020423
571333B	B1.G102-0214.2	G1020214	571406X	B1.G102-0299.2	G1020299	571725B-AS	B1.G102-0423.2	G1020423
571333X	B1.G102-0214.2	G1020214	571407B	B1.G102-0272.2	G1020272	571726B	B1.G102-0423.2	G1020423
571334B	B1.G102-0216.2	G1020216	571407X	B1.G102-0272.2	G1020272	571726B-AS	B1.G102-0423.2	G1020423
571334B	B1.G102-0522.2	G1020522	571409B	B1.G102-0236.2	G1020236	571743B	B1.G102-0295.2	G1020295
571334X	B1.G102-0216.2	G1020216	571411B	B1.G102-0608.2	G1020608	571743X	B1.G102-0295.2	G1020295
571334X	B1.G102-0522.2	G1020522	571412B	B1.G102-0332.2	G1020332	571744B	B1.G102-0216.2	G1020216
571335B	B1.G102-0216.2	G1020216	571417B	B1.G102-0510.2	G1020510	571744B	B1.G102-0522.2	G1020522
571335B	B1.G102-0522.2	G1020522	571418B	B1.G102-0955.2	G1020955	571745B	B1.G102-0617.2	G1020617
571335X	B1.G102-0216.2	G1020216	571425B	B1.G102-0327.2	G1020327	571745X	B1.G102-0617.2	G1020617
571335X	B1.G102-0522.2	G1020522	571425B-AS	B1.G102-0327.2	G1020327	571746B	B1.G102-0618.2	G1020618
571344B	B1.G102-0022.2	G1020022	571435B	B1.G102-0339.2	G1020339	571746X	B1.G102-0618.2	G1020618
571350B	B1.G102-0246.2	G1020246	571457B	B1.G102-0956.2	G1020956	571747B	B1.G102-0777.2	G1020777
571351B	B1.G102-0026.2	G1020026	571458B	B1.G102-0315.2	G1020315	571747B-AS	B1.G102-0777.2	G1020777
571353B	B1.G102-0257.2	G1020257	571460B	B1.G102-0304.2	G1020304	571749B	B1.G102-0259.2	G1020259
571353B-AS	B1.G102-0257.2	G1020257	571462B	B1.G102-0246.2	G1020246	571754B	B1.G102-0885.2	G1020885
571353X	B1.G102-0257.2	G1020257	571464B	B1.G102-0141.2	G1020141	571755B	B1.G102-0886.2	G1020886
571355B	B1.G102-0474.2	G1020474	571473B	B1.G102-0275.2	G1020275	571757B	B1.G102-0328.2	G1020328
571355B-AS	B1.G102-0474.2	G1020474	571473B-AS	B1.G102-0275.2	G1020275	571828B	B1.G102-0337.2	G1020337
571355X	B1.G102-0474.2	G1020474	571473X	B1.G102-0275.2	G1020275	571828B-AS	B1.G102-0337.2	G1020337
571356B	B1.G102-0196.2	G1020196	571476B	B1.G102-0326.2	G1020326	571832B	B1.G102-0320.2	G1020320
571356B	B1.G102-0197.2	G1020197	571492B	B1.G102-0317.2	G1020317	571833B	B1.G102-0015.2	G1020015
571356B-AS	B1.G102-0197.2	G1020197	571492B-AS	B1.G102-0317.2	G1020317	571833B-AS	B1.G102-0015.2	G1020015
571356X	B1.G102-0196.2	G1020196	571492X	B1.G102-0317.2	G1020317	571837B	B1.G102-0291.2	G1020291
571356X	B1.G102-0197.2	G1020197	571509B	B1.G102-0292.2	G1020292	571838B	B1.G102-0310.2	G1020310
571357B	B1.G102-0196.2	G1020196	571509B-AS	B1.G102-0292.2	G1020292	571838B-AS	B1.G102-0310.2	G1020310

# Cross reference list

Liste des correspondances / Tabella di conversione codici / Lista de comparação /



Lista porównawcza numerów / Porovnávací seznam čísel

BENDIX 	BENDIX 	BENDIX 			
571839B	B1.G102-0301.2 G1020301	571910B	B1.G102-0397.2 G1020397	571959B	B1.G102-0608.2 G1020608
571839X	B1.G102-0301.2 G1020301	571910B-AS	B1.G102-0397.2 G1020397	571959B-AS	B1.G102-0608.2 G1020608
571840B	B1.G102-0302.2 G1020302	571911B	B1.G102-0215.2 G1020215	571959X	B1.G102-0608.2 G1020608
571840X	B1.G102-0302.2 G1020302	571911X	B1.G102-0215.2 G1020215	571960B	B1.G102-0316.2 G1020316
571843B	B1.G102-0350.2 G1020350	571912B	B1.G102-0443.2 G1020443	571960B-AS	B1.G102-0316.2 G1020316
571844B	B1.G102-0742.2 G1020742	571912B-AS	B1.G102-0443.2 G1020443	571961B	B1.G102-0574.2 G1020574
571845B	B1.G102-0395.2 G1020395	571913B	B1.G102-0332.2 G1020333	571961B-AS	B1.G102-0574.2 G1020574
571845B-AS	B1.G102-0395.2 G1020395	571914B	B1.G102-0334.2 G1020334	571964B	B1.G102-0423.2 G1020423
571846B	B1.G102-0396.2 G1020396	571915B	B1.G102-0355.2 G1020355	571965B	B1.G102-0513.2 G1020513
571846B-AS	B1.G102-0396.2 G1020396	571915X	B1.G102-0355.2 G1020355	571966B	B1.G102-0570.2 G1020570
571847B	B1.G102-0347.2 G1020347	571916B	B1.G102-0427.2 G1020427	571967B	B1.G102-0505.2 G1020505
571847B-AS	B1.G102-0347.2 G1020347	571917B	B1.G102-0389.2 G1020389	571968B	B1.G102-0542.2 G1020542
571848B	B1.G102-0344.2 G1020344	571918B	B1.G102-0367.2 G1020367	571969B	B1.G102-0444.2 G1020444
571848X	B1.G102-0344.2 G1020344	571918B-AS	B1.G102-0367.2 G1020367	571971B	B1.G102-0463.2 G1020463
571850B	B1.G102-0290.2 G1020290	571919B	B1.G102-0451.2 G1020451	571972B	B1.G102-0469.2 G1020469
571852B	B1.G102-0372.2 G1020372	571919B-AS	B1.G102-0451.2 G1020451	571973B	B1.G102-0484.2 G1020484
571855B	B1.G102-0028.2 G1020028	571920B	B1.G102-0403.2 G1020403	571974B	B1.G102-0448.2 G1020448
571864B	B1.G102-0273.2 G1020273	571921B	B1.G102-0312.2 G1020312	571974B	B1.G102-0496.2 G1020496
571868B	B1.G102-0257.2 G1020257	571922B	B1.G102-0459.2 G1020459	571975B	B1.G102-0550.2 G1020550
571872B	B1.G102-0683.2 G1020683	571922B-AS	B1.G102-0459.2 G1020459	571979B	B1.G102-0384.2 G1020384
571872B-AS	B1.G102-0683.2 G1020683	571923B	B1.G102-0408.2 G1020408	571979X	B1.G102-0384.2 G1020384
571873B	B1.G102-0368.2 G1020368	571923D	B1.G102-0408.2 G1020408	571981B	B1.G102-0605.2 G1020605
571873B-AS	B1.G102-0368.2 G1020368	571923X	B1.G102-0408.2 G1020408	571981B-AS	B1.G102-0605.2 G1020605
571875B	B1.G102-0529.2 G1020529	571924B	B1.G102-0317.2 G1020317	571982B	B1.G102-0313.2 G1020313
571875B	B1.G102-0658.2 G1020658	571925B	B1.G102-0441.2 G1020441	571982X	B1.G102-0313.2 G1020313
571875B-AS	B1.G102-0658.2 G1020658	571925B-AS	B1.G102-0441.2 G1020441	571984B	B1.G102-0512.2 G1020512
571876B	B1.G102-0401.2 G1020401	571929B	B1.G102-0331.2 G1020331	571984B	B1.G102-0676.2 G1020676
571876B	B1.G102-0776.2 G1020776	571930B	B1.G102-0497.2 G1020497	571985B	B1.G102-0331.2 G1020331
571876B-AS	B1.G102-0401.2 G1020401	571930B-AS	B1.G102-0497.2 G1020497	571986B	B1.G102-0924.2 G1020924
571877B	B1.G102-0398.2 G1020398	571931B	B1.G102-0497.2 G1020497	571987B	B1.G102-0925.2 G1020925
571877B-AS	B1.G102-0398.2 G1020398	571931B-AS	B1.G102-0497.2 G1020497	571988B	B1.G102-0442.2 G1020442
571880B	B1.G102-0411.2 G1020411	571933B	B1.G102-0392.2 G1020392	571988B-AS	B1.G102-0442.2 G1020442
571880B-AS	B1.G102-0411.2 G1020411	571933B	B1.G102-0500.2 G1020500	571989B	B1.G102-0652.2 G1020652
571882B	B1.G102-0340.2 G1020340	571934B	B1.G102-0419.2 G1020419	571989B	B1.G102-0985.2 G1020985
571883B	B1.G102-0342.2 G1020342	571934B	B1.G102-0534.2 G1020534	571990B	B1.G102-0634.2 G1020634
571884B	B1.G102-0360.2 G1020360	571935B	B1.G102-0379.2 G1020379	571990B-AS	B1.G102-0634.2 G1020634
571887B	B1.G102-0340.2 G1020340	571936B	B1.G102-0415.2 G1020415	571991B	B1.G102-0638.2 G1020638
571893B	B1.G102-0298.2 G1020298	571939B	B1.G102-0390.2 G1020390	571991B-AS	B1.G102-0638.2 G1020638
571897B	B1.G102-0362.2 G1020362	571939X	B1.G102-0390.2 G1020390	571992B	B1.G102-0646.2 G1020646
571897X	B1.G102-0362.2 G1020362	571940B	B1.G102-0457.2 G1020457	571992B-AS	B1.G102-0646.2 G1020646
571898B	B1.G102-0363.2 G1020363	571940B	B1.G102-0779.2 G1020779	571994B	B1.G102-0591.2 G1020591
571898X	B1.G102-0363.2 G1020363	571941B	B1.G102-0458.2 G1020458	571994B-AS	B1.G102-0591.2 G1020591
571899B	B1.G102-0487.2 G1020487	571941B	B1.G102-0780.2 G1020780	571995B	B1.G102-0540.2 G1020540
571900B	B1.G102-0312.2 G1020312	571944B	B1.G102-0440.2 G1020440	571996B	B1.G102-0467.2 G1020467
571902B	B1.G102-0293.2 G1020293	571944B-AS	B1.G102-0440.2 G1020440	571997B	B1.G102-0642.2 G1020642
571902B-AS	B1.G102-0293.2 G1020293	571945B	B1.G102-0440.2 G1020440	571998B	B1.G102-0507.2 G1020507
571906B	B1.G102-0345.2 G1020345	571945B	B1.G120-1272.2 G1201272	572217B	B1.G120-1056.2 G1201056
571906B	B1.G102-0492.2 G1020492	571945B-AS	B1.G102-0440.2 G1020440	572245B	B1.G120-5404.2 G1205404
571906B	B1.G102-0549.2 G1020549	571946B	B1.G102-0582.2 G1020582	572340B	B1.G102-0722.2 G1020722
571906B	B1.G102-0676.2 G1020676	571947B	B1.G102-0584.2 G1020584	572405B	B1.G102-0714.2 G1020714
571906B	B1.G102-0755.2 G1020755	571947B-AS	B1.G102-0584.2 G1020584	572432B	B1.G120-5344.2 G1205344
571906X	B1.G102-0345.2 G1020345	571948B	B1.G102-0315.2 G1020315	572473B	B1.G120-1000.2 G1201000
571906X	B1.G102-0492.2 G1020492	571949B	B1.G102-0351.2 G1020351	572480B	B1.G102-0812.2 G1020812
571906X	B1.G102-0549.2 G1020549	571950B	B1.G102-0583.2 G1020583	572482B	B1.G102-0719.2 G1020719
571906X	B1.G102-0676.2 G1020676	571951B	B1.G102-0360.2 G1020360	572485B	B1.G102-0662.2 G1020662
571906X	B1.G102-0755.2 G1020755	571955B	B1.G102-0196.2 G1020196	572491B	B1.G102-0712.2 G1020712
571908B	B1.G102-0359.2 G1020359	571955B	B1.G102-0421.2 G1020421	572492B	B1.G102-0713.2 G1020713

# Cross reference list

Liste des correspondances / Tabella di conversione codici / Lista de comparação /



Lista porównawcza numerów / Porovnávací seznam čísel

BENDIX		BENDIX		BENDIX				
572498B	B1.G120-5230.2	G1205230	573032B	B1.G102-0492.2	G1020492	573105B	B1.G120-1128.2	G1201128
572505B	B1.G120-5234.2	G1205234	573032B	B1.G102-0920.2	G1020920	573106B	B1.G102-0534.2	G1020534
572509B	B1.G120-5366.2	G1205366	573033B	B1.G120-5215.2	G1205215	573107B	B1.G102-0624.2	G1020624
572510B	B1.G102-0478.2	G1020478	573036B	B1.G102-0513.2	G1020513	573109B	B1.G102-0427.2	G1020427
572515B	B1.G120-5333.2	G1205333	573037B	B1.G102-0313.2	G1020313	573110B	B1.G102-0595.2	G1020595
572516B	B1.G102-0663.2	G1020663	573038B	B1.G102-0654.2	G1020654	573111B	B1.G102-0409.2	G1020409
572524B	B1.G102-0988.2	G1020988	573039B	B1.G102-0537.2	G1020537	573112B	B1.G102-0566.2	G1020566
572526B	B1.G120-1047.2	G1201047	573041B	B1.G102-0519.2	G1020519	573113B	B1.G102-0516.2	G1020516
572549B	B1.G120-1025.2	G1201025	573042B	B1.G102-0473.2	G1020473	573114B	B1.G102-0517.2	G1020517
572550B	B1.G120-5418.2	G1205418	573043B	B1.G102-0882.2	G1020882	573115B	B1.G102-0518.2	G1020518
572553B	B1.G120-5242.2	G1205242	573045B	B1.G102-0527.2	G1020527	573118B	B1.G120-5238.2	G1205238
572569B	B1.G102-0994.2	G1020994	573045B	B1.G102-0593.2	G1020593	573120B	B1.G102-0563.2	G1020563
572570B	B1.G102-0979.2	G1020979	573046B	B1.G102-0533.2	G1020533	573122B	B1.G102-0610.2	G1020610
572575B	B1.G120-1029.2	G1201029	573046B-AS	B1.G102-0533.2	G1020533	573124B	B1.G102-0685.2	G1020685
572576B	B1.G102-0798.2	G1020798	573047B	B1.G102-0580.2	G1020580	573125B	B1.G102-0538.2	G1020538
572577B	B1.G120-1002.2	G1201002	573047B-AS	B1.G102-0580.2	G1020580	573125B	B1.G102-0741.2	G1020741
572579B	B1.G120-1013.2	G1201013	573048B	B1.G102-0529.2	G1020529	573127B	B1.G102-0733.2	G1020733
572580B	B1.G120-1014.2	G1201014	573049B	B1.G102-0654.2	G1020654	573128B	B1.G102-0680.2	G1020680
572584B	B1.G120-1085.2	G1201085	573050B	B1.G102-0524.2	G1020524	573130B	B1.G102-0496.2	G1020496
572590B	B1.G120-1035.2	G1201035	573052B	B1.G102-0956.2	G1020956	573131B	B1.G102-0762.2	G1020762
572593B	B1.G120-1033.2	G1201033	573053B	B1.G102-0422.2	G1020422	573132B	B1.G102-0761.2	G1020761
572594B	B1.G102-0974.2	G1020974	573055B	B1.G102-0627.2	G1020627	573133B	B1.G102-0660.2	G1020660
572595B	B1.G120-1022.2	G1201022	573056B	B1.G102-0648.2	G1020648	573134B	B1.G102-0745.2	G1020745
572598B	B1.G120-1065.2	G1201065	573058B	B1.G102-0633.2	G1020633	573135B	B1.G102-0830.2	G1020830
572601B	B1.G102-0768.2	G1020768	573058B-AS	B1.G102-0633.2	G1020633	573136B	B1.G102-0844.2	G1020844
572605B	B1.G102-0817.2	G1020817	573059B	B1.G102-0529.2	G1020529	573137B	B1.G102-0794.2	G1020794
572606B	B1.G102-0819.2	G1020819	573060B	B1.G102-0482.2	G1020482	573138B	B1.G102-0846.2	G1020846
572623B	B1.G120-1209.2	G1201209	573061B	B1.G102-0483.2	G1020483	573139B	B1.G102-0850.2	G1020850
572632B	B1.G102-0975.2	G1020975	573065B	B1.G102-0564.2	G1020564	573142B	B1.G102-0694.2	G1020694
573002B	B1.G102-0411.2	G1020411	573074B	B1.G102-0740.2	G1020740	573143B	B1.G102-0696.2	G1020696
573002B-AS	B1.G102-0411.2	G1020411	573074B	B1.G102-0987.2	G1020987	573144B	B1.G102-0573.2	G1020573
573003B	B1.G102-0578.2	G1020578	573074B	B1.G120-1224.2	G1201224	573145B	B1.G102-0644.2	G1020644
573003B-AS	B1.G102-0578.2	G1020578	573074X	B1.G102-0987.2	G1020987	573146B	B1.G102-0642.2	G1020642
573005B	B1.G102-0489.2	G1020489	573074X	B1.G120-1224.2	G1201224	573147B	B1.G102-0575.2	G1020575
573005B	B1.G102-0755.2	G1020755	573075B	B1.G102-0503.2	G1020503	573150B	B1.G102-0746.2	G1020746
573005B	B1.G102-0920.2	G1020920	573075B	B1.G120-1225.2	G1201225	573151B	B1.G102-0586.2	G1020586
573006B	B1.G102-0511.2	G1020511	573075X	B1.G120-1225.2	G1201225	573151B	B1.G102-0848.2	G1020848
573008B	B1.G102-0569.2	G1020569	573076B	B1.G102-0504.2	G1020504	573152B	B1.G102-0677.2	G1020677
573009B	B1.G102-0560.2	G1020560	573082B	B1.G102-0544.2	G1020544	573153B	B1.G102-0765.2	G1020765
573010B	B1.G102-0554.2	G1020554	573082B	B1.G102-0852.2	G1020852	573158B	B1.G102-0682.2	G1020682
573011B	B1.G102-0545.2	G1020545	573083B	B1.G102-0686.2	G1020686	573158B	B1.G102-0734.2	G1020734
573012B	B1.G102-0563.2	G1020563	573084B	B1.G102-0687.2	G1020687	573158B	B1.G102-0993.2	G1020993
573013B	B1.G102-0562.2	G1020562	573085B	B1.G102-0692.2	G1020692	573159B	B1.G102-0707.2	G1020707
573014B	B1.G102-0568.2	G1020568	573089B	B1.G102-0650.2	G1020650	573160B	B1.G102-0706.2	G1020706
573015B	B1.G102-0597.2	G1020597	573090B	B1.G102-0756.2	G1020756	573161B	B1.G102-0591.2	G1020591
573016B	B1.G102-0576.2	G1020576	573091B	B1.G102-0632.2	G1020632	573164B	B1.G102-0737.2	G1020737
573017B	B1.G102-0547.2	G1020547	573092B	B1.G102-0677.2	G1020677	573165B	B1.G102-0738.2	G1020738
573018B	B1.G102-0470.2	G1020470	573092B-AS	B1.G102-0677.2	G1020677	573168B	B1.G102-0613.2	G1020613
573019B	B1.G102-0567.2	G1020567	573093B	B1.G102-0441.2	G1020441	573169B	B1.G102-0621.2	G1020621
573020B	B1.G102-0562.2	G1020562	573093B-AS	B1.G102-0441.2	G1020441	573170B	B1.G102-0987.2	G1020987
573021B	B1.G102-0480.2	G1020480	573095B	B1.G102-0459.2	G1020459	573171B	B1.G102-0614.2	G1020614
573022B	B1.G102-0557.2	G1020557	573095B-AS	B1.G102-0459.2	G1020459	573172B	B1.G102-0740.2	G1020740
573025B	B1.G102-0548.2	G1020548	573096B	B1.G102-0514.2	G1020514	573173B	B1.G102-0701.2	G1020701
573027B	B1.G102-0602.2	G1020602	573100B	B1.G102-0615.2	G1020615	573175B	B1.G102-0860.2	G1020860
573028B	B1.G102-0604.2	G1020604	573101B	B1.G102-0732.2	G1020732	573177B	B1.G102-0659.2	G1020659
573029B	B1.G102-0603.2	G1020603	573102B	B1.G102-0901.2	G1020901	573178B	B1.G102-0877.2	G1020877
573031B	B1.G102-0735.2	G1020735	573105B	B1.G102-0515.2	G1020515	573179B	B1.G120-1009.2	G1201009

# Cross reference list

Liste des correspondances / Tabella di conversione codici / Lista de comparação /

Lista porównawcza numerów / Porovnávací seznam čísel

BENDIX 	BENDIX 	BENDIX 			
573181B	B1.G102-0939.2 G1020939	573269B	B1.G120-1143.2 G1201143	B 338 648	B1.G210-0190.1 G2110190
573184B	B1.G102-0735.2 G1020735	573270B	B1.G120-1145.2 G1201145	B 338 652	B1.G209-0120.1 G2109120
573186B	B1.G102-0670.2 G1020670	573272B	B1.G102-0874.2 G1020874	B 338 656	B1.G220-0125.1 G2120125
573186B	B1.G102-0727.2 G1020727	573274B	B1.G102-0730.2 G1020730	B 342 708 NA	B1.G102-0257.2 G1020257
573192B	B1.G102-0790.2 G1020790	573275B	B1.G102-0801.2 G1020801	<b>BENTLEY</b>	
573193B	B1.G102-0792.2 G1020792	573276B	B1.G102-0800.2 G1020800		
573194B	B1.G102-0799.2 G1020799	573277B	B1.G102-0802.2 G1020802		
573196B	B1.G102-0678.2 G1020678	573278B	B1.G120-5241.2 G1205241	PC57341PA	B1.G102-0683.2 G1020683
573196B	B1.G102-0754.2 G1020754	573280B	B1.G102-0937.2 G1020937	<b>BMW</b>	
573197B	B1.G102-0753.2 G1020753	573281B	B1.G102-0938.2 G1020938		
573199B	B1.G102-0772.2 G1020772	573282B	B1.G102-0710.2 G1020710		
573200B	B1.G102-0796.2 G1020796	573284B	B1.G102-0875.2 G1020875	34 10 1 166 071	B1.G225-0138.1 G2125138
573201B	B1.G102-0889.2 G1020889	573284B	B1.G102-0876.2 G1020876	34 11 1 157 569	B1.G102-0474.2 G1020474
573202B	B1.G102-0862.2 G1020862	573285B	B1.G102-0887.2 G1020887	34 11 1 157 813	B1.G102-0474.2 G1020474
573204B	B1.G102-0858.2 G1020858	573288B	B1.G102-0774.2 G1020774	34 11 1 158 265	B1.G102-0474.2 G1020474
573206B	B1.G102-0593.2 G1020593	573289B	B1.G102-0921.2 G1020921	34 11 1 159 279	B1.G102-0474.2 G1020474
573207B	B1.G102-0678.2 G1020678	573291B	B1.G102-0935.2 G1020935	34 11 1 160 356	B1.G102-0608.2 G1020608
573209B	B1.G102-0622.2 G1020622	573296B	B1.G120-1010.2 G1201010	34 11 1 160 450	B1.G102-0474.2 G1020474
573209B	B1.G102-0772.2 G1020772	573297B	B1.G120-1011.2 G1201011	34 11 1 160 532	B1.G102-0608.2 G1020608
573211B	B1.G102-0896.2 G1020896	573297B	B1.G120-1011.2 G1201011	34 11 1 160 673	B1.G212-0126.1 G2112126
573218B	B1.G102-0625.2 G1020625	573300B	B1.G102-0806.2 G1020806	34 11 1 160 674	B1.G222-0115.1 G2122115
573219B	B1.G102-0758.2 G1020758	573307B	B1.G102-0672.2 G1020672	34 11 1 161 437	B1.G102-0608.2 G1020608
573219B	B1.G102-0759.2 G1020759	573308B	B1.G102-0833.2 G1020833	34 11 1 161 445	B1.G102-0608.2 G1020608
573220B	B1.G102-0691.2 G1020691	573313B	B1.G120-1148.2 G1201148	34 11 1 162 210	B1.G102-0372.2 G1020372
573221B	B1.G102-0751.2 G1020751	573313B	B1.G120-1149.2 G1201149	34 11 1 162 282	B1.G222-0115.1 G2122115
573222B	B1.G102-0752.2 G1020752	573316B	B1.G102-0834.2 G1020834	34 11 1 162 288	B1.G222-0115.1 G2122115
573224B	B1.G102-0588.2 G1020588	573325B	B1.G102-0928.2 G1020928	34 11 1 162 535	B1.G102-0474.2 G1020474
573227B	B1.G102-0711.2 G1020711	573326B	B1.G120-1147.2 G1201147	34 11 1 162 884	B1.G102-0683.2 G1020683
573228B	B1.G102-0637.2 G1020637	573329B	B1.G120-1079.2 G1201079	34 11 1 163 013	B1.G222-0159.1 G2122159
573228B	B1.G102-0803.2 G1020803	573335B	B1.G102-0953.2 G1020953	34 11 1 163 081	B1.G222-0159.1 G2122159
573229B	B1.G102-0883.2 G1020883	573339B	B1.G102-0711.2 G1020711	34 11 1 163 307	B1.G102-0368.2 G1020368
573234B	B1.G102-0856.2 G1020856	573339B	B1.G102-0999.2 G1020999	34 11 1 163 387	B1.G102-0411.2 G1020411
573235B	B1.G102-0630.2 G1020630	573357B	B1.G102-0905.2 G1020905	34 11 1 163 850	B1.G102-0608.2 G1020608
573235B	B1.G102-0995.2 G1020995	573359B	B1.G102-0905.2 G1020905	34 11 1 163 921	B1.G102-0372.2 G1020372
573241B	B1.G102-0859.2 G1020859	573506B	B1.G102-0357.2 G1020357	34 11 1 163 953	B1.G102-0411.2 G1020411
573243B	B1.G102-0834.2 G1020834	573507B	B1.G102-0766.2 G1020766	34 11 1 164 199	B1.G222-0115.1 G2122115
573244B	B1.G102-0871.2 G1020871	573507B	B1.G102-0922.2 G1020922	34 11 1 164 330	B1.G102-0411.2 G1020411
573247B	B1.G102-0983.2 G1020983	573508B	B1.G102-0769.2 G1020769	34 11 1 164 331	B1.G102-0411.2 G1020411
573248B	B1.G102-0963.2 G1020963	573509B	B1.G102-0770.2 G1020770	34 11 1 164 431	B1.G222-0115.1 G2122115
573249B	B1.G120-1053.2 G1201053	573510B	B1.G102-0940.2 G1020940	34 11 1 164 498	B1.G102-0608.2 G1020608
573250B	B1.G102-0787.2 G1020787	573511B	B1.G102-0828.2 G1020828	34 11 1 164 500	B1.G102-0608.2 G1020608
573250B	B1.G102-0900.2 G1020900	573512B	B1.G102-0825.2 G1020825	34 11 1 164 539	B1.G222-0160.1 G2122160
573252B	B1.G102-0572.2 G1020572	573519B	B1.G102-0766.2 G1020766	34 11 1 164 627	B1.G102-0411.2 G1020411
573255B	B1.G120-1059.2 G1201059	573519B	B1.G102-0922.2 G1020922	34 11 1 164 629	B1.G102-0411.2 G1020411
573257B	B1.G102-0933.2 G1020933	B 314 699 NA	B1.G102-0097.2 G1020097	34 11 1 164 737	B1.G102-0608.2 G1020608
573257B	B1.G102-0934.2 G1020934	B 331 403 NA	B1.G102-0147.2 G1020147	34 11 1 164 839	B1.G222-0159.1 G2122159
573259B	B1.G120-1004.2 G1201004	B 333 094	B1.G210-0151.1 G2110151	34 11 1 164 921	B1.G222-0115.1 G2122115
573259B	B1.G120-1005.2 G1201005	B 333 150	B1.G212-0106.1 G2112106	34 11 1 165 227	B1.G102-0368.2 G1020368
573260B	B1.G102-0763.2 G1020763	B 333 168	B1.G213-0161.1 G2113161	34 11 1 165 455	B1.G222-0115.1 G2122115
573260B	B1.G102-0872.2 G1020872	B 333 190	B1.G220-0123.1 G2120123	34 11 1 165 555	B1.G102-0608.2 G1020608
573261B	B1.G102-0764.2 G1020764	B 333 641	B1.G212-0116.1 G2112116	34 11 1 165 556	B1.G102-0608.2 G1020608
573261B	B1.G102-0873.2 G1020873	B 333 666	B1.G210-0187.1 G2110187	34 11 1 165 557	B1.G102-0608.2 G1020608
573263B	B1.G102-0786.2 G1020786	B 333 672	B1.G208-0104.1 G2108104	34 11 1 165 626	B1.G102-0683.2 G1020683
573263B	B1.G120-1135.2 G1201135	B 333 799 NA	B1.G102-0025.2 G1020025	34 11 1 166 161	B1.G102-0683.2 G1020683
573266B	B1.G102-0952.2 G1020952	B 333 800 NA	B1.G102-0010.2 G1020010	34 11 2 228 248	B1.G102-0474.2 G1020474
573267B	B1.G102-0951.2 G1020951	B 333 804 NA	B1.G102-0009.2 G1020009	34 11 2 229 031	B1.G102-0368.2 G1020368
573268B	B1.G120-1126.2 G1201126	B 333 837	B1.G102-0009.2 G1020009	34 11 2 282 090	B1.G102-0368.2 G1020368
		B 333 844 NA	B1.G102-0044.2 G1020044	34 11 2 282 166	B1.G102-0368.2 G1020368
				34 11 2 282 554	B1.G102-0474.2 G1020474







# Cross reference list

Liste des correspondances / Tabella di conversione codici / Lista de comparação /



Lista porównawcza numerów / Porovnávací seznam čísel

BMW		BMW		BMW				
34 11 2 282 556	B1.G102-0368.2	G1020368	34 11 6 779 652	B1.G102-0591.2	G1020591	34 21 6 761 281	B1.G102-0415.2	G1020415
34 11 2 283 865	B1.G102-0634.2	G1020634	34 11 6 780 711	B1.G102-0939.2	G1020939	34 21 6 761 285	B1.G102-0637.2	G1020637
34 11 3 404 362	B1.G102-0591.2	G1020591	34 11 6 781 873	B1.G102-0634.2	G1020634	34 21 6 761 286	B1.G102-0638.2	G1020638
34 11 3 427 503	B1.G102-0368.2	G1020368	34 11 6 783 542	B1.G102-0971.2	G1020971	34 21 6 763 043	B1.G102-0588.2	G1020588
34 11 4 074 370	B1.G102-0806.2	G1020806	34 11 6 794 917	B1.G102-0939.2	G1020939	34 21 6 763 044	B1.G102-0588.2	G1020588
34 11 6 750 148	B1.G102-0591.2	G1020591	34 11 6 799 166	B1.G102-0848.2	G1020848	34 21 6 764 651	B1.G220-0195.1	G2120195
34 11 6 752 482	B1.G102-0608.2	G1020608	34 11 6 852 253	B1.G102-0806.2	G1020806	34 21 6 764 653	B1.G220-0204.1	G2120204
34 11 6 752 731	B1.G102-0608.2	G1020608	34 11 6 854 997	B1.G222-0238.1	G2122238	34 21 6 767 145	B1.G102-0844.2	G1020844
34 11 6 753 668	B1.G102-0634.2	G1020634	34 11 6 854 998	B1.G224-0197.1	G2124197	34 21 6 767 146	B1.G102-0844.2	G1020844
34 11 6 753 799	B1.G102-0683.2	G1020683	34 11 6 855 152	B1.G222-0160.1	G2122160	34 21 6 767 150	B1.G102-0850.2	G1020850
34 11 6 754 705	B1.G102-0591.2	G1020591	34 11 6 855 156	B1.G225-0138.1	G2125138	34 21 6 768 471	B1.G102-0638.2	G1020638
34 11 6 756 128	B1.G102-0608.2	G1020608	34 11 9 070 047	B1.G102-0608.2	G1020608	34 21 6 769 105	B1.G102-0887.2	G1020887
34 11 6 757 526	B1.G222-0160.1	G2122160	34 21 1 157 334	B1.G102-0308.2	G1020308	34 21 6 770 252	B1.G102-0648.2	G1020648
34 11 6 757 750	B1.G212-0126.1	G2112126	34 21 1 157 814	B1.G102-0308.2	G1020308	34 21 6 773 161	B1.G102-0850.2	G1020850
34 11 6 761 237	B1.G102-0608.2	G1020608	34 21 1 158 221	B1.G102-0308.2	G1020308	34 21 6 774 417	B1.G102-0844.2	G1020844
34 11 6 761 242	B1.G102-0608.2	G1020608	34 21 1 158 266	B1.G102-0308.2	G1020308	34 21 6 774 692	B1.G102-0850.2	G1020850
34 11 6 761 243	B1.G102-0591.2	G1020591	34 21 1 158 268	B1.G102-0308.2	G1020308	34 21 6 775 678	B1.G102-0887.2	G1020887
34 11 6 761 244	B1.G102-0608.2	G1020608	34 21 1 158 642	B1.G102-0308.2	G1020308	34 21 6 776 937	B1.G102-0803.2	G1020803
34 11 6 761 246	B1.G102-0683.2	G1020683	34 21 1 158 936	B1.G210-0202.1	G2110202	34 21 6 777 240	B1.G102-0844.2	G1020844
34 11 6 761 249	B1.G102-0372.2	G1020372	34 21 1 160 198	B1.G102-0308.2	G1020308	34 21 6 778 168	B1.G102-0316.2	G1020316
34 11 6 761 252	B1.G102-0368.2	G1020368	34 21 1 160 340	B1.G102-0316.2	G1020316	34 21 6 779 294	B1.G102-0844.2	G1020844
34 11 6 761 278	B1.G102-0411.2	G1020411	34 21 1 160 533	B1.G102-0316.2	G1020316	34 21 6 788 183	B1.G102-0844.2	G1020844
34 11 6 761 279	B1.G102-0411.2	G1020411	34 21 1 160 809	B1.G210-0211.1	G2110211	34 21 6 788 275	B1.G120-1213.2	G1201213
34 11 6 761 280	B1.G102-0411.2	G1020411	34 21 1 161 455	B1.G102-0316.2	G1020316	34 21 6 791 938	B1.G102-0887.2	G1020887
34 11 6 761 283	B1.G102-0634.2	G1020634	34 21 1 162 289	B1.G210-0202.1	G2110202	34 21 6 855 007	B1.G220-0195.1	G2120195
34 11 6 763 089	B1.G102-0634.2	G1020634	34 21 1 162 315	B1.G219-0107.1	G2119107	34 21 6 855 008	B1.G220-0204.1	G2120204
34 11 6 763 305	B1.G102-0638.2	G1020638	34 21 1 162 446	B1.G102-0316.2	G1020316	34 21 6 855 155	B1.G219-0107.1	G2119107
34 11 6 763 591	B1.G102-0634.2	G1020634	34 21 1 162 536	B1.G102-0316.2	G1020316			
34 11 6 763 617	B1.G102-0586.2	G1020586	34 21 1 163 324	B1.G102-0367.2	G1020367			
34 11 6 763 618	B1.G102-0586.2	G1020586	34 21 1 163 326	B1.G102-0367.2	G1020367			
34 11 6 763 652	B1.G102-0746.2	G1020746	34 21 1 163 395	B1.G102-0415.2	G1020415	0 204 100 544	B1.G102-0605.2	G1020605
34 11 6 764 312	B1.G102-0746.2	G1020746	34 21 1 164 499	B1.G102-0316.2	G1020316	0 204 204 174	B1.G102-0583.2	G1020583
34 11 6 764 540	B1.G102-0634.2	G1020634	34 21 1 164 501	B1.G102-0316.2	G1020316	0 986 424 027	B1.G102-0291.2	G1020291
34 11 6 764 641	B1.G222-0238.1	G2122238	34 21 1 164 581	B1.G102-0316.2	G1020316	0 986 424 030	B1.G102-0301.2	G1020301
34 11 6 764 643	B1.G224-0197.1	G2124197	34 21 1 164 582	B1.G102-0367.2	G1020367	0 986 424 031	B1.G102-0302.2	G1020302
34 11 6 766 224	B1.G222-0160.1	G2122160	34 21 1 164 582	B1.G102-0367.2	G1020367	0 986 424 033	B1.G102-0310.2	G1020310
34 11 6 766 239	B1.G222-0115.1	G2122115	34 21 1 165 211	B1.G219-0107.1	G2119107	0 986 424 098	B1.G102-0141.2	G1020141
34 11 6 767 061	B1.G222-0159.1	G2122159	34 21 1 165 233	B1.G102-0316.2	G1020316	0 986 424 185	B1.G102-0367.2	G1020367
34 11 6 767 143	B1.G102-0794.2	G1020794	34 21 1 165 235	B1.G102-0316.2	G1020316	0 986 424 209	B1.G102-0372.2	G1020372
34 11 6 767 144	B1.G102-0794.2	G1020794	34 21 1 165 457	B1.G210-0202.1	G2110202	0 986 424 218	B1.G102-0742.2	G1020742
34 11 6 767 191	B1.G102-0634.2	G1020634	34 21 1 165 563	B1.G219-0108.1	G2119108	0 986 424 219	B1.G102-0397.2	G1020397
34 11 6 767 580	B1.G102-0634.2	G1020634	34 21 2 284 685	B1.G102-0638.2	G1020638	0 986 424 223	B1.G102-0363.2	G1020363
34 11 6 768 287	B1.G102-0746.2	G1020746	34 21 3 403 241	B1.G102-0367.2	G1020367	0 986 424 227	B1.G102-0362.2	G1020362
34 11 6 769 305	B1.G225-0138.1	G2125138	34 21 6 750 160	B1.G102-0367.2	G1020367	0 986 424 229	B1.G102-0395.2	G1020395
34 11 6 769 763	B1.G102-0846.2	G1020846	34 21 6 750 190	B1.G102-0316.2	G1020316	0 986 424 233	B1.G102-0401.2	G1020401
34 11 6 769 951	B1.G102-0846.2	G1020846	34 21 6 752 632	B1.G102-0367.2	G1020367	0 986 424 233	B1.G102-0776.2	G1020776
34 11 6 770 575	B1.G102-0746.2	G1020746	34 21 6 753 850	B1.G102-0367.2	G1020367	0 986 424 233	B1.G102-0776.2	G1020776
34 11 6 771 837	B1.G102-0794.2	G1020794	34 21 6 753 850	B1.G102-0637.2	G1020637	0 986 424 234	B1.G102-0398.2	G1020398
34 11 6 771 838	B1.G102-0794.2	G1020794	34 21 6 757 536	B1.G102-0638.2	G1020638	0 986 424 235	B1.G102-0290.2	G1020290
34 11 6 771 868	B1.G102-0848.2	G1020848	34 21 6 758 552	B1.G210-0211.1	G2110211	0 986 424 236	B1.G102-0312.2	G1020312
34 11 6 772 669	B1.G224-0197.1	G2124197	34 21 6 758 870	B1.G102-0637.2	G1020637	0 986 424 246	B1.G102-0340.2	G1020340
34 11 6 774 050	B1.G102-0794.2	G1020794	34 21 6 761 238	B1.G102-0316.2	G1020316	0 986 424 248	B1.G102-0360.2	G1020360
34 11 6 774 258	B1.G102-0746.2	G1020746	34 21 6 761 239	B1.G102-0316.2	G1020316	0 986 424 248	B1.G102-0360.2	G1020360
34 11 6 776 161	B1.G102-0971.2	G1020971	34 21 6 761 240	B1.G102-0316.2	G1020316	0 986 424 277	B1.G102-0885.2	G1020885
34 11 6 777 772	B1.G102-0848.2	G1020848	34 21 6 761 241	B1.G102-0367.2	G1020367	0 986 424 295	B1.G102-0721.2	G1020721
34 11 6 778 403	B1.G102-0806.2	G1020806	34 21 6 761 248	B1.G102-0316.2	G1020316	0 986 424 313	B1.G120-5404.2	G1205404
34 11 6 779 293	B1.G102-0806.2	G1020806	34 21 6 761 250	B1.G102-0367.2	G1020367	0 986 424 347	B1.G102-0355.2	G1020355
			34 21 6 761 251	B1.G102-0367.2	G1020367	0 986 424 359	B1.G102-0265.2	G1020265
			34 21 6 761 253	B1.G102-0308.2	G1020308	0 986 424 360	B1.G102-0403.2	G1020403
						0 986 424 361	B1.G102-0408.2	G1020408

# Cross reference list

Liste des correspondances / Tabella di conversione codici / Lista de comparação /



Lista porównawcza numerów / Porovnávací seznam čísel

<b>BOSCH</b>		<b>BOSCH</b>		<b>BOSCH</b>				
0 986 424 362	B1.G102-0342.2	G1020342	0 986 424 516	B1.G102-0583.2	G1020583	0 986 424 644	B1.G102-0423.2	G1020423
0 986 424 364	B1.G102-0331.2	G1020331	0 986 424 517	B1.G102-0924.2	G1020924	0 986 424 645	B1.G102-0467.2	G1020467
0 986 424 365	B1.G102-0367.2	G1020367	0 986 424 518	B1.G102-0925.2	G1020925	0 986 424 646	B1.G102-0610.2	G1020610
0 986 424 371	B1.G102-0457.2	G1020457	0 986 424 519	B1.G102-0441.2	G1020441	0 986 424 649	B1.G102-0683.2	G1020683
0 986 424 375	B1.G102-0658.2	G1020658	0 986 424 520	B1.G102-0442.2	G1020442	0 986 424 651	B1.G102-0634.2	G1020634
0 986 424 376	B1.G102-0299.2	G1020299	0 986 424 522	B1.G102-0544.2	G1020544	0 986 424 652	B1.G102-0646.2	G1020646
0 986 424 379	B1.G102-0298.2	G1020298	0 986 424 522	B1.G102-0852.2	G1020852	0 986 424 653	B1.G102-0637.2	G1020637
0 986 424 394	B1.G102-0065.2	G1020065	0 986 424 527	B1.G102-0545.2	G1020545	0 986 424 654	B1.G102-0648.2	G1020648
0 986 424 400	B1.G102-0411.2	G1020411	0 986 424 528	B1.G102-0560.2	G1020560	0 986 424 657	B1.G102-0595.2	G1020595
0 986 424 402	B1.G102-0419.2	G1020419	0 986 424 529	B1.G102-0513.2	G1020513	0 986 424 659	B1.G102-0614.2	G1020614
0 986 424 410	B1.G102-0293.2	G1020293	0 986 424 533	B1.G102-0569.2	G1020569	0 986 424 659	B1.G102-0735.2	G1020735
0 986 424 411	B1.G102-0443.2	G1020443	0 986 424 534	B1.G102-0714.2	G1020714	0 986 424 662	B1.G102-0529.2	G1020529
0 986 424 414	B1.G102-0451.2	G1020451	0 986 424 537	B1.G102-0527.2	G1020527	0 986 424 667	B1.G102-0316.2	G1020316
0 986 424 415	B1.G102-0350.2	G1020350	0 986 424 537	B1.G102-0534.2	G1020534	0 986 424 668	B1.G120-5366.2	G1205366
0 986 424 416	B1.G102-0332.2	G1020333	0 986 424 539	B1.G102-0480.2	G1020480	0 986 424 671	B1.G102-0563.2	G1020563
0 986 424 427	B1.G102-0458.2	G1020458	0 986 424 540	B1.G102-0694.2	G1020694	0 986 424 672	B1.G102-0524.2	G1020524
0 986 424 427	B1.G102-0780.2	G1020780	0 986 424 541	B1.G102-0537.2	G1020537	0 986 424 673	B1.G102-0533.2	G1020533
0 986 424 449	B1.G102-0390.2	G1020390	0 986 424 542	B1.G102-0654.2	G1020654	0 986 424 674	B1.G102-0511.2	G1020511
0 986 424 450	B1.G102-0505.2	G1020505	0 986 424 543	B1.G102-0389.2	G1020389	0 986 424 675	B1.G102-0627.2	G1020627
0 986 424 451	B1.G102-0459.2	G1020459	0 986 424 544	B1.G102-0351.2	G1020351	0 986 424 676	B1.G102-0403.2	G1020403
0 986 424 452	B1.G102-0293.2	G1020293	0 986 424 544	B1.G102-0469.2	G1020469	0 986 424 677	B1.G102-0650.2	G1020650
0 986 424 454	B1.G102-0891.2	G1020891	0 986 424 545	B1.G102-0236.2	G1020236	0 986 424 680	B1.G102-0568.2	G1020568
0 986 424 455	B1.G102-0497.2	G1020497	0 986 424 545	B1.G102-0384.2	G1020384	0 986 424 681	B1.G102-0882.2	G1020882
0 986 424 456	B1.G102-0542.2	G1020542	0 986 424 546	B1.G102-0562.2	G1020562	0 986 424 683	B1.G102-0563.2	G1020563
0 986 424 457	B1.G102-0550.2	G1020550	0 986 424 547	B1.G102-0400.2	G1020400	0 986 424 691	B1.G102-0597.2	G1020597
0 986 424 459	B1.G102-0415.2	G1020415	0 986 424 549	B1.G102-0605.2	G1020605	0 986 424 698	B1.G102-0638.2	G1020638
0 986 424 460	B1.G102-0379.2	G1020379	0 986 424 553	B1.G102-0568.2	G1020568	0 986 424 699	B1.G102-0652.2	G1020652
0 986 424 461	B1.G102-0642.2	G1020642	0 986 424 554	B1.G102-0496.2	G1020496	0 986 424 699	B1.G102-0985.2	G1020985
0 986 424 462	B1.G102-0334.2	G1020334	0 986 424 556	B1.G102-0482.2	G1020482	0 986 424 701	B1.G102-0692.2	G1020692
0 986 424 463	B1.G102-0396.2	G1020396	0 986 424 558	B1.G102-0519.2	G1020519	0 986 424 703	B1.G102-0516.2	G1020516
0 986 424 468	B1.G102-0444.2	G1020444	0 986 424 559	B1.G102-0564.2	G1020564	0 986 424 704	B1.G102-0518.2	G1020518
0 986 424 469	B1.G102-0440.2	G1020440	0 986 424 569	B1.G102-0883.2	G1020883	0 986 424 705	B1.G102-0677.2	G1020677
0 986 424 469	B1.G102-0615.2	G1020615	0 986 424 578	B1.G102-0473.2	G1020473	0 986 424 706	B1.G102-0313.2	G1020313
0 986 424 469	B1.G120-1272.2	G1201272	0 986 424 580	B1.G102-0604.2	G1020604	0 986 424 707	B1.G102-0765.2	G1020765
0 986 424 470	B1.G102-0440.2	G1020440	0 986 424 581	B1.G102-0603.2	G1020603	0 986 424 716	B1.G120-5241.2	G1205241
0 986 424 471	B1.G102-0540.2	G1020540	0 986 424 582	B1.G102-0602.2	G1020602	0 986 424 717	B1.G120-5230.2	G1205230
0 986 424 472	B1.G102-0507.2	G1020507	0 986 424 583	B1.G102-0570.2	G1020570	0 986 424 721	B1.G102-0901.2	G1020901
0 986 424 475	B1.G102-0574.2	G1020574	0 986 424 584	B1.G102-0368.2	G1020368	0 986 424 723	B1.G102-0409.2	G1020409
0 986 424 476	B1.G102-0582.2	G1020582	0 986 424 585	B1.G120-5203.2	G1205203	0 986 424 735	B1.G102-0712.2	G1020712
0 986 424 478	B1.G102-0554.2	G1020554	0 986 424 586	B1.G120-5215.2	G1205215	0 986 424 739	B1.G102-0710.2	G1020710
0 986 424 479	B1.G102-0550.2	G1020550	0 986 424 593	B1.G102-0342.2	G1020342	0 986 424 740	B1.G102-0709.2	G1020709
0 986 424 481	B1.G102-0312.2	G1020312	0 986 424 594	B1.G102-0515.2	G1020515	0 986 424 741	B1.G102-0711.2	G1020711
0 986 424 482	B1.G102-0313.2	G1020313	0 986 424 595	B1.G102-0504.2	G1020504	0 986 424 743	B1.G102-0756.2	G1020756
0 986 424 483	B1.G102-0608.2	G1020608	0 986 424 596	B1.G102-0503.2	G1020503	0 986 424 744	B1.G102-0885.2	G1020885
0 986 424 484	B1.G102-0316.2	G1020316	0 986 424 596	B1.G102-0738.2	G1020738	0 986 424 745	B1.G102-0886.2	G1020886
0 986 424 485	B1.G102-0411.2	G1020411	0 986 424 597	B1.G102-0737.2	G1020737	0 986 424 747	B1.G102-0658.2	G1020658
0 986 424 487	B1.G102-0497.2	G1020497	0 986 424 597	B1.G102-0740.2	G1020740	0 986 424 748	B1.G102-0658.2	G1020658
0 986 424 488	B1.G102-0642.2	G1020642	0 986 424 614	B1.G102-0624.2	G1020624	0 986 424 751	B1.G102-0549.2	G1020549
0 986 424 496	B1.G102-0441.2	G1020441	0 986 424 615	B1.G102-0882.2	G1020882	0 986 424 754	B1.G102-0271.2	G1020271
0 986 424 497	B1.G102-0422.2	G1020422	0 986 424 616	B1.G102-0548.2	G1020548	0 986 424 756	B1.G102-0567.2	G1020567
0 986 424 501	B1.G102-0512.2	G1020512	0 986 424 617	B1.G102-0470.2	G1020470	0 986 424 764	B1.G102-0634.2	G1020634
0 986 424 503	B1.G102-0463.2	G1020463	0 986 424 618	B1.G102-0547.2	G1020547	0 986 424 766	B1.G102-0588.2	G1020588
0 986 424 506	B1.G102-0359.2	G1020359	0 986 424 619	B1.G102-0576.2	G1020576	0 986 424 767	B1.G102-0591.2	G1020591
0 986 424 507	B1.G102-0392.2	G1020392	0 986 424 633	B1.G102-0557.2	G1020557	0 986 424 769	B1.G102-0517.2	G1020517
0 986 424 507	B1.G102-0500.2	G1020500	0 986 424 634	B1.G102-0686.2	G1020686	0 986 424 775	B1.G102-0572.2	G1020572
0 986 424 508	B1.G102-0421.2	G1020421	0 986 424 635	B1.G102-0687.2	G1020687	0 986 424 777	B1.G102-0580.2	G1020580
0 986 424 514	B1.G102-0427.2	G1020427	0 986 424 636	B1.G102-0633.2	G1020633	0 986 424 778	B1.G102-0642.2	G1020642

# Cross reference list

Liste des correspondances / Tabella di conversione codici / Lista de comparação /



Lista porównawcza numerów / Porovnávací seznam čísel

BOSCH		BOSCH		BOSCH				
0 986 424 779	B1.G102-0644.2	G1020644	0 986 460 970	B1.G102-0522.2	G1020522	0 986 469 960	B1.G102-0308.2	G1020308
0 986 424 780	B1.G102-0593.2	G1020593	0 986 460 971	B1.G102-0265.2	G1020265	0 986 478 010	B1.G210-0151.1	G2110151
0 986 424 784	B1.G102-0740.2	G1020740	0 986 460 977	B1.G102-0337.2	G1020337	0 986 478 011	B1.G212-0106.1	G2112106
0 986 424 785	B1.G102-0685.2	G1020685	0 986 460 983	B1.G102-0295.2	G1020295	0 986 478 012	B1.G225-0138.1	G2125138
0 986 424 786	B1.G102-0613.2	G1020613	0 986 460 983	B1.G102-0296.2	G1020296	0 986 478 017	B1.G220-0123.1	G2120123
0 986 424 787	B1.G102-0632.2	G1020632	0 986 460 991	B1.G102-0886.2	G1020886	0 986 478 019	B1.G210-0178.1	G2110178
0 986 424 788	B1.G102-0478.2	G1020478	0 986 460 995	B1.G102-0955.2	G1020955	0 986 478 046	B1.G210-0187.1	G2110187
0 986 424 789	B1.G102-0514.2	G1020514	0 986 461 106	B1.G102-0344.2	G1020344	0 986 478 081	B1.G213-0161.1	G2113161
0 986 424 790	B1.G102-0713.2	G1020713	0 986 461 119	B1.G102-0305.2	G1020305	0 986 478 105	B1.G212-0116.1	G2112116
0 986 424 792	B1.G102-0573.2	G1020573	0 986 461 119	B1.G102-0621.2	G1020621	0 986 478 124	B1.G221-0106.1	G2121106
0 986 424 793	B1.G102-0573.2	G1020573	0 986 461 129	B1.G102-0369.2	G1020369	0 986 478 132	B1.G210-0201.1	G2110201
0 986 424 794	B1.G102-0622.2	G1020622	0 986 461 130	B1.G102-0269.2	G1020269	0 986 478 160	B1.G224-0131.1	G2124131
0 986 424 795	B1.G102-0538.2	G1020538	0 986 461 131	B1.G120-1000.2	G1201000	0 986 478 170	B1.G224-0120.1	G2124120
0 986 424 795	B1.G102-0741.2	G1020741	0 986 461 148	B1.G102-0327.2	G1020327	0 986 478 174	B1.G221-0105.1	G2121105
0 986 424 796	B1.G102-0682.2	G1020682	0 986 461 149	B1.G102-0216.2	G1020216	0 986 478 188	B1.G209-0120.1	G2109120
0 986 424 796	B1.G102-0734.2	G1020734	0 986 461 149	B1.G102-0777.2	G1020777	0 986 478 192	B1.G220-0115.1	G2120115
0 986 424 797	B1.G102-0680.2	G1020680	0 986 461 396	B1.G102-0065.2	G1020065	0 986 478 238	B1.G210-0190.1	G2110190
0 986 424 798	B1.G102-0663.2	G1020663	0 986 461 752	B1.G102-0956.2	G1020956	0 986 478 246	B1.G208-0107.1	G2108107
0 986 424 801	B1.G102-0513.2	G1020513	0 986 461 753	B1.G102-0347.2	G1020347	0 986 478 255	B1.G209-0120.1	G2109120
0 986 424 803	B1.G102-0714.2	G1020714	0 986 461 757	B1.G102-0328.2	G1020328	0 986 478 268	B1.G220-0133.1	G2120133
0 986 424 806	B1.G102-0754.2	G1020754	0 986 461 759	B1.G102-0722.2	G1020722	0 986 478 273	B1.G208-0104.1	G2108104
0 986 424 811	B1.G120-1002.2	G1201002	0 986 461 763	B1.G102-0214.2	G1020214	0 986 478 276	B1.G220-0125.1	G2120125
0 986 424 812	B1.G102-0638.2	G1020638	0 986 461 763	B1.G102-0296.2	G1020296	0 986 478 288	B1.G212-0137.1	G2112137
0 986 424 813	B1.G102-0566.2	G1020566	0 986 461 764	B1.G102-0292.2	G1020292	0 986 478 308	B1.G220-0128.1	G2120128
0 986 424 814	B1.G120-5230.2	G1205230	0 986 461 765	B1.G102-0326.2	G1020326	0 986 478 325	B1.G209-0114.1	G2109114
0 986 424 816	B1.G120-5234.2	G1205234	0 986 461 769	B1.G102-0345.2	G1020345	0 986 478 327	B1.G224-0115.1	G2124115
0 986 424 817	B1.G102-0721.2	G1020721	0 986 461 769	B1.G102-0492.2	G1020492	0 986 478 329	B1.G213-0178.1	G2113178
0 986 424 819	B1.G102-0794.2	G1020794	0 986 461 769	B1.G102-0549.2	G1020549	0 986 478 331	B1.G210-0111.1	G2110111
0 986 424 820	B1.G102-0844.2	G1020844	0 986 461 769	B1.G102-0755.2	G1020755	0 986 478 341	B1.G210-0209.1	G2110209
0 986 424 821	B1.G102-0850.2	G1020850	0 986 461 769	B1.G102-0920.2	G1020920	0 986 478 343	B1.G212-0127.1	G2112127
0 986 424 822	B1.G102-0586.2	G1020586	0 986 462 282	B1.G102-0097.2	G1020097	0 986 478 344	B1.G210-0115.1	G2110115
0 986 424 824	B1.G102-0682.2	G1020682	0 986 463 473	B1.G102-0065.2	G1020065	0 986 478 350	B1.G210-0212.1	G2110212
0 986 424 825	B1.G102-0745.2	G1020745	0 986 465 141	B1.G102-0015.2	G1020015	0 986 478 370	B1.G220-0132.1	G2120132
0 986 424 825	B1.G102-0792.2	G1020792	0 986 466 346	B1.G102-0219.2	G1020219	0 986 478 420	B1.G210-0225.1	G2110225
0 986 424 829	B1.G102-0732.2	G1020732	0 986 466 346	B1.G102-0323.2	G1020323	0 986 478 421	B1.G210-0223.1	G2110223
0 986 424 831	B1.G102-0662.2	G1020662	0 986 466 402	B1.G102-0334.2	G1020334	0 986 478 423	B1.G225-0119.1	G2125119
0 986 424 832	B1.G102-0891.2	G1020891	0 986 466 683	B1.G102-0201.2	G1020201	0 986 478 432	B1.G208-0108.1	G2108108
0 986 460 002	B1.G102-0584.2	G1020584	0 986 466 683	B1.G102-0489.2	G1020489	0 986 478 434	B1.G224-0127.1	G2124127
0 986 460 937	B1.G102-0311.2	G1020311	0 986 466 693	B1.G102-0197.2	G1020197	0 986 478 442	B1.G208-0109.1	G2108109
0 986 460 938	B1.G102-0317.2	G1020317	0 986 466 700	B1.G102-0196.2	G1020196	0 986 478 449	B1.G225-0119.1	G2125119
0 986 460 941	B1.G102-0304.2	G1020304	0 986 466 871	B1.G102-0046.2	G1020046	0 986 478 461	B1.G210-0258.1	G2110258
0 986 460 943	B1.G102-0273.2	G1020273	0 986 466 874	B1.G102-0022.2	G1020022	0 986 478 464	B1.G208-0106.1	G2108106
0 986 460 944	B1.G102-0274.2	G1020274	0 986 467 411	B1.G102-0147.2	G1020147	0 986 478 467	B1.G225-0123.1	G2125123
0 986 460 949	B1.G102-0423.2	G1020423	0 986 467 720	B1.G102-0501.2	G1020501	0 986 478 470	B1.G232-0115.1	G2132115
0 986 460 952	B1.G102-0608.2	G1020608	0 986 467 760	B1.G102-0141.2	G1020141	0 986 478 471	B1.G228-0125.1	G2128125
0 986 460 954	B1.G102-0315.2	G1020315	0 986 468 380	B1.G102-0140.2	G1020140	0 986 478 479	B1.G209-0136.1	G2109136
0 986 460 955	B1.G102-0272.2	G1020272	0 986 468 870	B1.G102-0009.2	G1020009	0 986 478 481	B1.G209-0133.1	G2109133
0 986 460 958	B1.G102-0329.2	G1020329	0 986 468 871	B1.G102-0010.2	G1020010	0 986 478 482	B1.G222-0163.1	G2122163
0 986 460 962	B1.G102-0618.2	G1020618	0 986 468 873	B1.G102-0009.2	G1020009	0 986 478 492	B1.G209-0124.1	G2109124
0 986 460 963	B1.G102-0617.2	G1020617	0 986 468 890	B1.G102-0025.2	G1020025	0 986 478 501	B1.G210-0196.1	G2110196
0 986 460 964	B1.G102-0316.2	G1020316	0 986 469 070	B1.G102-0026.2	G1020026	0 986 478 502	B1.G220-0147.1	G2120147
0 986 460 965	B1.G102-0400.2	G1020400	0 986 469 191	B1.G102-0326.2	G1020326	0 986 478 511	B1.G212-0126.1	G2112126
0 986 460 967	B1.G102-0373.2	G1020373	0 986 469 390	B1.G102-0015.2	G1020015	0 986 478 513	B1.G222-0115.1	G2122115
0 986 460 967	B1.G102-0487.2	G1020487	0 986 469 410	B1.G102-0044.2	G1020044	0 986 478 515	B1.G220-0142.1	G2120142
0 986 460 968	B1.G102-0259.2	G1020259	0 986 469 810	B1.G102-0028.2	G1020028	0 986 478 521	B1.G222-0145.1	G2122145
0 986 460 969	B1.G102-0320.2	G1020320	0 986 469 860	B1.G102-0214.2	G1020214	0 986 478 535	B1.G220-0140.1	G2120140
0 986 460 970	B1.G102-0216.2	G1020216	0 986 469 860	B1.G102-0215.2	G1020215	0 986 478 545	B1.G215-0105.1	G2115105

# Cross reference list

Liste des correspondances / Tabella di conversione codici / Lista de comparação /



Lista porównawcza numerów / Porovnávací seznam čísel

BOSCH		BOSCH		BOSCH				
0 986 478 546	B1.G225-0105.1	G2125105	0 986 478 881	B1.G224-0152.1	G2124152	0 986 479 179	B1.G225-0165.1	G2125165
0 986 478 552	B1.G208-0106.1	G2108106	0 986 478 882	B1.G210-0251.1	G2110251	0 986 479 183	B1.G225-0170.1	G2125170
0 986 478 557	B1.G208-0108.1	G2108108	0 986 478 883	B1.G225-0131.1	G2125131	0 986 479 186	B1.G222-0232.1	G2122232
0 986 478 561	B1.G210-0202.1	G2110202	0 986 478 884	B1.G210-0250.1	G2110250	0 986 479 189	B1.G211-0152.1	G2111152
0 986 478 564	B1.G210-0215.1	G2110215	0 986 478 887	B1.G213-0185.1	G2113185	0 986 479 190	B1.G220-0174.1	G2120174
0 986 478 570	B1.G219-0108.1	G2119108	0 986 478 892	B1.G222-0172.1	G2122172	0 986 479 194	B1.G212-0162.1	G2112162
0 986 478 571	B1.G222-0160.1	G2122160	0 986 478 893	B1.G225-0114.1	G2125114	0 986 479 204	B1.G230-0115.1	G2130115
0 986 478 582	B1.G218-0131.1	G2118131	0 986 478 896	B1.G220-0155.1	G2120155	0 986 479 209	B1.G224-0191.1	G2124191
0 986 478 584	B1.G225-0124.1	G2125124	0 986 478 898	B1.G210-0229.1	G2110229	0 986 479 211	B1.G230-0114.1	G2130114
0 986 478 588	B1.G225-0119.1	G2125119	0 986 478 968	B1.G220-0175.1	G2120175	0 986 479 214	B1.G222-0238.1	G2122238
0 986 478 590	B1.G224-0158.1	G2124158	0 986 478 970	B1.G212-0155.1	G2112155	0 986 479 216	B1.G224-0197.1	G2124197
0 986 478 598	B1.G222-0148.1	G2122148	0 986 478 976	B1.G225-0113.1	G2125113	0 986 479 218	B1.G220-0195.1	G2120195
0 986 478 601	B1.G210-0271.1	G2110271	0 986 478 979	B1.G226-0120.1	G2126120	0 986 479 223	B1.G222-0231.1	G2122231
0 986 478 605	B1.G220-0146.1	G2120146	0 986 478 985	B1.G230-0113.1	G2130113	0 986 479 235	B1.G208-0113.1	G2108113
0 986 478 606	B1.G222-0204.1	G2122204	0 986 478 986	B1.G210-0261.1	G2110261	0 986 479 239	B1.G220-0180.1	G2120180
0 986 478 608	B1.G209-0137.1	G2109137	0 986 478 988	B1.G222-0151.1	G2122151	0 986 479 244	B1.G218-0131.1	G2118131
0 986 478 609	B1.G212-0131.1	G2112131	0 986 479 012	B1.G220-0175.1	G2120175	0 986 479 247	B1.G212-0169.1	G2112169
0 986 478 610	B1.G208-0106.1	G2108106	0 986 479 036	B1.G218-0137.1	G2118137	0 986 479 253	B1.G211-0158.1	G2111158
0 986 478 615	B1.G213-0181.1	G2113181	0 986 479 038	B1.G228-0176.1	G2128176	0 986 479 254	B1.G211-0145.1	G2111145
0 986 478 616	B1.G226-0120.1	G2126120	0 986 479 039	B1.G228-0176.1	G2128176	0 986 479 256	B1.G210-0324.1	G2110324
0 986 478 618	B1.G222-0194.1	G2122194	0 986 479 040	B1.G228-0142.1	G2128142	0 986 479 260	B1.G230-0176.1	G2130176
0 986 478 620	B1.G210-0232.1	G2110232	0 986 479 041	B1.G210-0278.1	G2110278	0 986 479 261	B1.G228-0154.1	G2128154
0 986 478 621	B1.G218-0106.1	G2118106	0 986 479 057	B1.G225-0137.1	G2125137	0 986 479 263	B1.G220-0204.1	G2120204
0 986 478 624	B1.G225-0110.1	G2125110	0 986 479 058	B1.G225-0158.1	G2125158	0 986 479 281	B1.G208-0109.1	G2108109
0 986 478 626	B1.G210-0217.1	G2110217	0 986 479 065	B1.G216-0124.1	G2116124	0 986 479 286	B1.G218-0145.1	G2118145
0 986 478 639	B1.G222-0197.1	G2122197	0 986 479 067	B1.G210-0285.1	G2110285	0 986 479 294	B1.G228-0203.1	G2128203
0 986 478 641	B1.G210-0211.1	G2110211	0 986 479 068	B1.G212-0154.1	G2112154	0 986 479 297	B1.G224-0127.1	G2124127
0 986 478 642	B1.G219-0107.1	G2119107	0 986 479 070	B1.G211-0154.1	G2111154	0 986 479 298	B1.G216-0124.1	G2116124
0 986 478 672	B1.G210-0213.1	G2110213	0 986 479 077	B1.G225-0148.1	G2125148	0 986 479 300	B1.G230-0175.1	G2130175
0 986 478 712	B1.G213-0195.1	G2113195	0 986 479 078	B1.G228-0132.1	G2128132	0 986 479 301	B1.G225-0149.1	G2125149
0 986 478 716	B1.G210-0229.1	G2110229	0 986 479 080	B1.G222-0216.1	G2122216	0 986 479 302	B1.G234-0100.1	G2134100
0 986 478 718	B1.G224-0161.1	G2124161	0 986 479 084	B1.G225-0155.1	G2125155	0 986 479 308	B1.G220-0211.1	G2120211
0 986 478 730	B1.G224-0166.1	G2124166	0 986 479 085	B1.G225-0155.1	G2125155	0 986 479 312	B1.G224-0127.1	G2124127
0 986 478 734	B1.G224-0171.1	G2124171	0 986 479 087	B1.G209-0139.1	G2109139	0 986 479 314	B1.G224-0138.1	G2124138
0 986 478 743	B1.G224-0169.1	G2124169	0 986 479 088	B1.G225-0145.1	G2125145	0 986 479 317	B1.G216-0123.1	G2116123
0 986 478 759	B1.G210-0210.1	G2110210	0 986 479 097	B1.G222-0211.1	G2122211	0 986 479 332	B1.G232-0144.1	G2132144
0 986 478 785	B1.G208-0108.1	G2108108	0 986 479 098	B1.G222-0210.1	G2122210	0 986 479 358	B1.G226-0154.1	G2126154
0 986 478 797	B1.G224-0171.1	G2124171	0 986 479 099	B1.G210-0277.1	G2110277	0 986 479 360	B1.G209-0142.1	G2109142
0 986 478 810	B1.G222-0147.1	G2122147	0 986 479 103	B1.G222-0216.1	G2122216	0 986 479 362	B1.G209-0157.1	G2109157
0 986 478 831	B1.G226-0106.1	G2126106	0 986 479 104	B1.G207-0109.1	G2107109	0 986 479 363	B1.G222-0240.1	G2122240
0 986 478 842	B1.G224-0138.1	G2124138	0 986 479 106	B1.G212-0157.1	G2112157	0 986 479 371	B1.G210-0312.1	G2110312
0 986 478 845	B1.G225-0114.1	G2125114	0 986 479 107	B1.G225-0141.1	G2125141	0 986 479 382	B1.G212-0178.1	G2112178
0 986 478 847	B1.G213-0184.1	G2113184	0 986 479 113	B1.G225-0142.1	G2125142	0 986 479 402	B1.G212-0184.1	G2112184
0 986 478 848	B1.G222-0159.1	G2122159	0 986 479 121	B1.G225-0184.1	G2120184	0 986 479 467	B1.G225-0184.1	G2125184
0 986 478 849	B1.G222-0161.1	G2122161	0 986 479 131	B1.G210-0302.1	G2110302	0 986 479 553	B1.G224-0221.1	G2124221
0 986 478 852	B1.G222-0150.1	G2122150	0 986 479 135	B1.G228-0177.1	G2128177	0 986 479 555	B1.G224-0222.1	G2124222
0 986 478 853	B1.G222-0151.1	G2122151	0 986 479 143	B1.G228-0164.1	G2128164	0 986 479 556	B1.G222-0270.1	G2122270
0 986 478 856	B1.G212-0141.1	G2112141	0 986 479 155	B1.G212-0158.1	G2112158	0 986 479 566	B1.G223-0113.1	G2123113
0 986 478 859	B1.G213-0182.1	G2113182	0 986 479 157	B1.G225-0171.1	G2125171	0 986 479 632	B1.G220-0180.1	G2120180
0 986 478 866	B1.G208-0109.1	G2108109	0 986 479 164	B1.G212-0171.1	G2112171	0 986 479 677	B1.G210-0356.1	G2110356
0 986 478 867	B1.G225-0113.1	G2125113	0 986 479 165	B1.G212-0116.1	G2112116	0 986 479 743	B1.G212-0169.1	G2124169
0 986 478 868	B1.G209-0123.1	G2109123	0 986 479 169	B1.G211-0155.1	G2111155	0 986 490 260	B1.G102-0339.2	G1020339
0 986 478 869	B1.G222-0152.1	G2122152	0 986 479 170	B1.G211-0158.1	G2111158	0 986 490 500	B1.G102-0271.2	G1020271
0 986 478 871	B1.G212-0138.1	G2112138	0 986 479 171	B1.G225-0162.1	G2125162	0 986 490 550	B1.G102-0257.2	G1020257
0 986 478 872	B1.G225-0115.1	G2125115	0 986 479 173	B1.G225-0117.1	G2125117	0 986 490 640	B1.G102-0474.2	G1020474
0 986 478 874	B1.G212-0144.1	G2112144	0 986 479 173	B1.G225-0199.1	G2125199	0 986 490 800	B1.G102-0213.2	G1020213
0 986 478 877	B1.G210-0230.1	G2110230	0 986 479 178	B1.G211-0164.1	G2111164	0 986 490 800	B1.G102-0299.2	G1020299

# Cross reference list

Liste des correspondances / Tabella di conversione codici / Lista de comparação /



Lista porównawcza numerów / Porovnávací seznam čísel

BOSCH		BOSCH		BOSCH				
0 986 490 891	B1.G102-0213.2	G1020213	0 986 494 049	B1.G102-0518.2	G1020518	0 986 494 125	B1.G102-0672.2	G1020672
0 986 491 030	B1.G102-0236.2	G1020236	0 986 494 050	B1.G102-0313.2	G1020313	0 986 494 126	B1.G102-0672.2	G1020672
0 986 491 050	B1.G102-0184.2	G1020184	0 986 494 051	B1.G102-0658.2	G1020658	0 986 494 127	B1.G102-0727.2	G1020727
0 986 491 441	B1.G102-0246.2	G1020246	0 986 494 052	B1.G102-0632.2	G1020632	0 986 494 129	B1.G102-0774.2	G1020774
0 986 491 900	B1.G102-0258.2	G1020258	0 986 494 053	B1.G102-0682.2	G1020682	0 986 494 130	B1.G102-0666.2	G1020666
0 986 492 020	B1.G102-0332.2	G1020333	0 986 494 053	B1.G102-0734.2	G1020734	0 986 494 135	B1.G102-0812.2	G1020812
0 986 494 000	B1.G102-0395.2	G1020395	0 986 494 054	B1.G102-0662.2	G1020662	0 986 494 136	B1.G120-1013.2	G1201013
0 986 494 001	B1.G102-0401.2	G1020401	0 986 494 055	B1.G102-0373.2	G1020373	0 986 494 139	B1.G120-1033.2	G1201033
0 986 494 001	B1.G102-0776.2	G1020776	0 986 494 057	B1.G102-0344.2	G1020344	0 986 494 153	B1.G120-5333.2	G1205333
0 986 494 002	B1.G102-0398.2	G1020398	0 986 494 058	B1.G102-0257.2	G1020257	0 986 494 154	B1.G120-1022.2	G1201022
0 986 494 003	B1.G102-0312.2	G1020312	0 986 494 061	B1.G102-0850.2	G1020850	0 986 494 157	B1.G102-0833.2	G1020833
0 986 494 004	B1.G102-0360.2	G1020360	0 986 494 062	B1.G102-0682.2	G1020682	0 986 494 157	B1.G102-0858.2	G1020858
0 986 494 004	B1.G102-0473.2	G1020473	0 986 494 063	B1.G102-0648.2	G1020648	0 986 494 160	B1.G120-1059.2	G1201059
0 986 494 005	B1.G102-0408.2	G1020408	0 986 494 064	B1.G120-1047.2	G1201047	0 986 494 161	B1.G102-0933.2	G1020933
0 986 494 006	B1.G102-0367.2	G1020367	0 986 494 065	B1.G102-0830.2	G1020830	0 986 494 161	B1.G102-0934.2	G1020934
0 986 494 007	B1.G102-0848.2	G1020848	0 986 494 070	B1.G102-0737.2	G1020737	0 986 494 166	B1.G102-0659.2	G1020659
0 986 494 008	B1.G102-0419.2	G1020419	0 986 494 071	B1.G102-0701.2	G1020701	0 986 494 169	B1.G102-0889.2	G1020889
0 986 494 009	B1.G102-0415.2	G1020415	0 986 494 073	B1.G102-0650.2	G1020650	0 986 494 170	B1.G102-0801.2	G1020801
0 986 494 010	B1.G102-0444.2	G1020444	0 986 494 074	B1.G102-0614.2	G1020614	0 986 494 171	B1.G102-0802.2	G1020802
0 986 494 011	B1.G102-0507.2	G1020507	0 986 494 075	B1.G102-0896.2	G1020896	0 986 494 175	B1.G102-0900.2	G1020900
0 986 494 012	B1.G102-0574.2	G1020574	0 986 494 076	B1.G102-0625.2	G1020625	0 986 494 194	B1.G102-0770.2	G1020770
0 986 494 013	B1.G102-0582.2	G1020582	0 986 494 077	B1.G102-0772.2	G1020772	0 986 494 195	B1.G120-1053.2	G1201053
0 986 494 014	B1.G102-0554.2	G1020554	0 986 494 081	B1.G102-0751.2	G1020751	0 986 494 206	B1.G120-1079.2	G1201079
0 986 494 015	B1.G102-0608.2	G1020608	0 986 494 082	B1.G102-0752.2	G1020752	0 986 494 236	B1.G102-0800.2	G1020800
0 986 494 016	B1.G102-0441.2	G1020441	0 986 494 085	B1.G102-0829.2	G1020829	0 986 494 241	B1.G120-1085.2	G1201085
0 986 494 017	B1.G102-0422.2	G1020422	0 986 494 087	B1.G102-0661.2	G1020661	0 986 494 247	B1.G120-1135.2	G1201135
0 986 494 018	B1.G102-0512.2	G1020512	0 986 494 087	B1.G102-0855.2	G1020855	0 986 494 248	B1.G102-0900.2	G1020900
0 986 494 019	B1.G102-0463.2	G1020463	0 986 494 092	B1.G102-0858.2	G1020858	0 986 494 255	B1.G102-0975.2	G1020975
0 986 494 020	B1.G102-0359.2	G1020359	0 986 494 095	B1.G102-0660.2	G1020660	0 986 494 262	B1.G102-0686.2	G1020686
0 986 494 021	B1.G102-0421.2	G1020421	0 986 494 096	B1.G102-0846.2	G1020846	0 986 494 271	B1.G102-0754.2	G1020754
0 986 494 022	B1.G102-0442.2	G1020442	0 986 494 097	B1.G102-0761.2	G1020761	0 986 494 272	B1.G102-0850.2	G1020850
0 986 494 023	B1.G102-0544.2	G1020544	0 986 494 098	B1.G102-0762.2	G1020762	0 986 494 275	B1.G120-1145.2	G1201145
0 986 494 023	B1.G102-0852.2	G1020852	0 986 494 099	B1.G102-0630.2	G1020630	0 986 494 279	B1.G120-1143.2	G1201143
0 986 494 024	B1.G102-0569.2	G1020569	0 986 494 099	B1.G102-0799.2	G1020799	0 986 494 284	B1.G102-0505.2	G1020505
0 986 494 025	B1.G102-0654.2	G1020654	0 986 494 099	B1.G102-0995.2	G1020995	0 986 494 285	B1.G102-0632.2	G1020632
0 986 494 026	B1.G102-0562.2	G1020562	0 986 494 101	B1.G102-0798.2	G1020798	0 986 494 286	B1.G102-0637.2	G1020637
0 986 494 028	B1.G102-0368.2	G1020368	0 986 494 103	B1.G102-0753.2	G1020753	0 986 494 297	B1.G120-1148.2	G1201148
0 986 494 029	B1.G120-5215.2	G1205215	0 986 494 104	B1.G102-0754.2	G1020754	0 986 494 297	B1.G120-1149.2	G1201149
0 986 494 030	B1.G102-0515.2	G1020515	0 986 494 105	B1.G102-0733.2	G1020733	0 986 494 298	B1.G120-1147.2	G1201147
0 986 494 031	B1.G102-0624.2	G1020624	0 986 494 107	B1.G102-0707.2	G1020707	0 986 494 303	B1.G102-0758.2	G1020758
0 986 494 032	B1.G102-0470.2	G1020470	0 986 494 108	B1.G102-0691.2	G1020691	0 986 494 303	B1.G102-0759.2	G1020759
0 986 494 032	B1.G102-0670.2	G1020670	0 986 494 109	B1.G102-0764.2	G1020764	0 986 494 315	B1.G120-5418.2	G1205418
0 986 494 032	B1.G102-0727.2	G1020727	0 986 494 109	B1.G102-0873.2	G1020873	0 986 494 340	B1.G102-0560.2	G1020560
0 986 494 033	B1.G102-0867.2	G1020867	0 986 494 110	B1.G102-0730.2	G1020730	0 986 494 349	B1.G102-0746.2	G1020746
0 986 494 034	B1.G102-0871.2	G1020871	0 986 494 111	B1.G102-0763.2	G1020763	0 986 503 000	B1.G102-0009.2	G1020009
0 986 494 035	B1.G102-0557.2	G1020557	0 986 494 111	B1.G102-0872.2	G1020872	0 986 505 402	B1.G120-5242.2	G1205242
0 986 494 036	B1.G102-0634.2	G1020634	0 986 494 113	B1.G102-0737.2	G1020737	0 986 524 098	B1.G102-0141.2	G1020141
0 986 494 037	B1.G102-0595.2	G1020595	0 986 494 114	B1.G102-0952.2	G1020952	0 986 524 246	B1.G102-0340.2	G1020340
0 986 494 038	B1.G102-0735.2	G1020735	0 986 494 115	B1.G102-0951.2	G1020951	0 986 524 362	B1.G102-0342.2	G1020342
0 986 494 040	B1.G102-0529.2	G1020529	0 986 494 117	B1.G102-0848.2	G1020848	0 986 524 362	B1.G102-0484.2	G1020484
0 986 494 041	B1.G102-0533.2	G1020533	0 986 494 118	B1.G102-0586.2	G1020586	0 986 524 376	B1.G102-0299.2	G1020299
0 986 494 042	B1.G102-0511.2	G1020511	0 986 494 119	B1.G102-0758.2	G1020758	0 986 524 379	B1.G102-0298.2	G1020298
0 986 494 043	B1.G102-0627.2	G1020627	0 986 494 119	B1.G102-0759.2	G1020759	0 986 560 938	B1.G102-0317.2	G1020317
0 986 494 044	B1.G102-0650.2	G1020650	0 986 494 120	B1.G102-0794.2	G1020794	0 986 560 943	B1.G102-0273.2	G1020273
0 986 494 046	B1.G102-0563.2	G1020563	0 986 494 121	B1.G102-0769.2	G1020769	0 986 560 944	B1.G102-0274.2	G1020274
0 986 494 047	B1.G102-0597.2	G1020597	0 986 494 122	B1.G102-0940.2	G1020940	0 986 560 949	B1.G102-0423.2	G1020423
0 986 494 048	B1.G102-0516.2	G1020516	0 986 494 123	B1.G102-0922.2	G1020922	0 986 560 952	B1.G102-0608.2	G1020608

# Cross reference list

Liste des correspondances / Tabella di conversione codici / Lista de comparação /

Lista porównawcza numerów / Porovnávací seznam čísel



BOSCH		BOSCH		BOSCH				
0 986 560 962	B1.G102-0618.2	G1020618	0 986 AB4 189	B1.G102-0317.2	G1020317	F 026 000 037	B1.G102-0777.2	G1020777
0 986 560 963	B1.G102-0617.2	G1020617	0 986 AB4 297	B1.G102-0403.2	G1020403	F 026 000 040	B1.G102-0510.2	G1020510
0 986 560 971	B1.G102-0265.2	G1020265	0 986 BB4 024	B1.G222-0161.1	G2122161	F 026 000 041	B1.G102-0501.2	G1020501
0 986 560 983	B1.G102-0295.2	G1020295	0 986 BB4 039	B1.G220-0133.1	G2120133	F 026 000 042	B1.G102-0141.2	G1020141
0 986 560 983	B1.G102-0296.2	G1020296	0 986 BB4 040	B1.G210-0187.1	G2110187	F 026 000 043	B1.G102-0015.2	G1020015
0 986 561 106	B1.G102-0344.2	G1020344	0 986 BB4 041	B1.G208-0107.1	G2108107	F 026 000 044	B1.G102-0214.2	G1020214
0 986 561 119	B1.G102-0305.2	G1020305	0 986 BB4 042	B1.G213-0178.1	G2113178	F 026 000 044	B1.G102-0215.2	G1020215
0 986 561 130	B1.G102-0269.2	G1020269	0 986 BB4 046	B1.G220-0142.1	G2120142	F 026 000 046	B1.G102-0257.2	G1020257
0 986 561 396	B1.G102-0065.2	G1020065	0 986 BB4 048	B1.G220-0115.1	G2120115	F 026 000 047	B1.G102-0236.2	G1020236
0 986 561 757	B1.G102-0328.2	G1020328	0 986 BB4 054	B1.G212-0106.1	G2112106	F 026 000 048	B1.G102-0312.2	G1020312
0 986 561 763	B1.G102-0214.2	G1020214	0 986 BB4 063	B1.G208-0104.1	G2108104	F 026 000 049	B1.G102-0505.2	G1020505
0 986 561 763	B1.G102-0296.2	G1020296	0 986 BB4 064	B1.G210-0111.1	G2110111	F 026 000 050	B1.G102-0312.2	G1020312
0 986 561 764	B1.G102-0292.2	G1020292	0 986 BB4 068	B1.G220-0132.1	G2120132	F 026 000 051	B1.G102-0301.2	G1020301
0 986 562 282	B1.G102-0097.2	G1020097	0 986 BB4 072	B1.G221-0106.1	G2121106	F 026 000 052	B1.G102-0310.2	G1020310
0 986 566 346	B1.G102-0219.2	G1020219	0 986 BB4 079	B1.G222-0148.1	G2122148	F 026 000 055	B1.G102-0141.2	G1020141
0 986 566 346	B1.G102-0323.2	G1020323	0 986 BB4 083	B1.G225-0105.1	G2125105	F 026 000 058	B1.G102-0363.2	G1020363
0 986 566 402	B1.G102-0334.2	G1020334	0 986 BB4 086	B1.G220-0125.1	G2120125	F 026 000 059	B1.G102-0290.2	G1020290
0 986 566 683	B1.G102-0201.2	G1020201	0 986 BB4 092	B1.G226-0106.1	G2126106	F 026 000 061	B1.G102-0355.2	G1020355
0 986 566 683	B1.G102-0489.2	G1020489	0 986 BB4 094	B1.G224-0127.1	G2124127	F 026 000 063	B1.G102-0331.2	G1020331
0 986 566 693	B1.G102-0197.2	G1020197	0 986 BB4 164	B1.G220-0140.1	G2120140	F 026 000 064	B1.G102-0457.2	G1020457
0 986 566 700	B1.G102-0196.2	G1020196	F 005 X10 237	B1.G102-0369.2	G1020369	F 026 000 066	B1.G102-0451.2	G1020451
0 986 567 411	B1.G102-0147.2	G1020147	F 026 000 000	B1.G102-0340.2	G1020340	F 026 000 067	B1.G102-0350.2	G1020350
0 986 567 720	B1.G102-0501.2	G1020501	F 026 000 001	B1.G102-0360.2	G1020360	F 026 000 068	B1.G102-0332.2	G1020332
0 986 567 760	B1.G102-0141.2	G1020141	F 026 000 001	B1.G102-0473.2	G1020473	F 026 000 070	B1.G102-0542.2	G1020542
0 986 568 380	B1.G102-0140.2	G1020140	F 026 000 002	B1.G102-0408.2	G1020408	F 026 000 071	B1.G102-0550.2	G1020550
0 986 568 870	B1.G102-0009.2	G1020009	F 026 000 003	B1.G102-0419.2	G1020419	F 026 000 072	B1.G102-0379.2	G1020379
0 986 568 871	B1.G102-0010.2	G1020010	F 026 000 004	B1.G102-0292.2	G1020292	F 026 000 073	B1.G102-0444.2	G1020444
0 986 568 890	B1.G102-0025.2	G1020025	F 026 000 004	B1.G102-0293.2	G1020293	F 026 000 074	B1.G102-0422.2	G1020422
0 986 569 070	B1.G102-0026.2	G1020026	F 026 000 005	B1.G102-0390.2	G1020390	F 026 000 075	B1.G102-0421.2	G1020421
0 986 569 390	B1.G102-0015.2	G1020015	F 026 000 006	B1.G102-0293.2	G1020293	F 026 000 076	B1.G102-0545.2	G1020545
0 986 569 410	B1.G102-0044.2	G1020044	F 026 000 007	B1.G102-0334.2	G1020334	F 026 000 078	B1.G102-0569.2	G1020569
0 986 569 860	B1.G102-0214.2	G1020214	F 026 000 008	B1.G102-0608.2	G1020608	F 026 000 079	B1.G102-0714.2	G1020714
0 986 569 860	B1.G102-0215.2	G1020215	F 026 000 009	B1.G102-0316.2	G1020316	F 026 000 081	B1.G102-0527.2	G1020527
0 986 590 550	B1.G102-0257.2	G1020257	F 026 000 010	B1.G102-0423.2	G1020423	F 026 000 081	B1.G102-0534.2	G1020534
0 986 590 640	B1.G102-0474.2	G1020474	F 026 000 011	B1.G102-0467.2	G1020467	F 026 000 082	B1.G102-0480.2	G1020480
0 986 590 800	B1.G102-0213.2	G1020213	F 026 000 012	B1.G102-0317.2	G1020317	F 026 000 083	B1.G102-0578.2	G1020578
0 986 590 800	B1.G102-0299.2	G1020299	F 026 000 013	B1.G102-0304.2	G1020304	F 026 000 083	B1.G102-0694.2	G1020694
0 986 591 050	B1.G102-0184.2	G1020184	F 026 000 014	B1.G102-0608.2	G1020608	F 026 000 084	B1.G102-0537.2	G1020537
0 986 592 020	B1.G102-0332.2	G1020332	F 026 000 015	B1.G102-0344.2	G1020344	F 026 000 085	B1.G102-0351.2	G1020351
0 986 AB2 028	B1.G120-5404.2	G1205404	F 026 000 016	B1.G102-0334.2	G1020334	F 026 000 085	B1.G102-0469.2	G1020469
0 986 AB2 096	B1.G120-5333.2	G1205333	F 026 000 017	B1.G102-0009.2	G1020009	F 026 000 086	B1.G102-0519.2	G1020519
0 986 AB2 104	B1.G120-5230.2	G1205230	F 026 000 018	B1.G102-0009.2	G1020009	F 026 000 088	B1.G102-0403.2	G1020403
0 986 AB2 136	B1.G102-0975.2	G1020975	F 026 000 019	B1.G102-0025.2	G1020025	F 026 000 089	B1.G102-0885.2	G1020885
0 986 AB2 138	B1.G120-1022.2	G1201022	F 026 000 020	B1.G102-0044.2	G1020044	F 026 000 090	B1.G102-0886.2	G1020886
0 986 AB2 458	B1.G102-0721.2	G1020721	F 026 000 021	B1.G102-0885.2	G1020885	F 026 000 091	B1.G102-0311.2	G1020311
0 986 AB2 665	B1.G102-0722.2	G1020722	F 026 000 022	B1.G102-0298.2	G1020298	F 026 000 093	B1.G102-0273.2	G1020273
0 986 AB3 802	B1.G102-0463.2	G1020463	F 026 000 022	B1.G102-0305.2	G1020305	F 026 000 094	B1.G102-0196.2	G1020196
0 986 AB3 803	B1.G102-0492.2	G1020492	F 026 000 023	B1.G102-0443.2	G1020443	F 026 000 094	B1.G102-0274.2	G1020274
0 986 AB3 805	B1.G102-0274.2	G1020274	F 026 000 024	B1.G102-0458.2	G1020458	F 026 000 096	B1.G102-0423.2	G1020423
0 986 AB3 806	B1.G102-0295.2	G1020295	F 026 000 025	B1.G102-0497.2	G1020497	F 026 000 098	B1.G102-0315.2	G1020315
0 986 AB3 818	B1.G102-0492.2	G1020492	F 026 000 026	B1.G102-0440.2	G1020440	F 026 000 099	B1.G102-0272.2	G1020272
0 986 AB3 834	B1.G102-0714.2	G1020714	F 026 000 027	B1.G102-0554.2	G1020554	F 026 000 100	B1.G102-0329.2	G1020329
0 986 AB3 840	B1.G120-5404.2	G1205404	F 026 000 029	B1.G102-0654.2	G1020654	F 026 000 102	B1.G102-0618.2	G1020618
0 986 AB3 845	B1.G120-5242.2	G1205242	F 026 000 030	B1.G102-0610.2	G1020610	F 026 000 103	B1.G102-0617.2	G1020617
0 986 AB4 150	B1.G120-5404.2	G1205404	F 026 000 035	B1.G102-0886.2	G1020886	F 026 000 104	B1.G102-0320.2	G1020320
0 986 AB4 166	B1.G102-0258.2	G1020258	F 026 000 036	B1.G102-0305.2	G1020305	F 026 000 105	B1.G102-0522.2	G1020522
0 986 AB4 166	B1.G102-0317.2	G1020317	F 026 000 036	B1.G102-0621.2	G1020621	F 026 000 106	B1.G102-0265.2	G1020265



# Cross reference list

Liste des correspondances / Tabella di conversione codici / Lista de comparação /



Lista porównawcza numerów / Porovnávací seznam čísel

BOSCH			CHEVROLET		CHRYSLER			
F 026 000 107	B1.G102-0337.2	G1020337	96179110	B1.G224-0115.1	G2124115	5103 790AA	B1.G102-0891.2	G1020891
F 026 000 112	B1.G102-0955.2	G1020955	96284392	B1.G213-0195.1	G2113195	5114 424AA	B1.G120-5203.2	G1205203
F 026 000 119	B1.G102-0269.2	G1020269	96320531	B1.G213-0195.1	G2113195	5114 555AA	B1.G102-0401.2	G1020401
F 026 000 119	B1.G102-0275.2	G1020275	96455424	B1.G213-0195.1	G2113195	5126 300AA	B1.G102-0441.2	G1020441
F 026 000 125	B1.G102-0327.2	G1020327	96626070	B1.G102-0979.2	G1020979	5139 218AA	B1.G102-0401.2	G1020401
F 026 000 126	B1.G102-0065.2	G1020065	96626076	B1.G102-0981.2	G1020981	5139 902AA	B1.G102-0441.2	G1020441
F 026 000 127	B1.G102-0956.2	G1020956	11046948372	B1.G102-0317.2	G1020317	5143 230AA	B1.G102-0683.2	G1020683
F 026 000 128	B1.G102-0347.2	G1020347	11046952012	B1.G102-0258.2	G1020258	5143 633AA	B1.G102-0400.2	G1020400
F 026 000 129	B1.G102-0328.2	G1020328				5191 231AA	B1.G120-5241.2	G1205241
F 026 000 130	B1.G102-0214.2	G1020214	<b>CHRYSLER</b>			6800 6732AA	B1.G102-0769.2	G1020769
F 026 000 130	B1.G102-0296.2	G1020296	0 4762 669	B1.G120-5203.2	G1205203	6800 6732AB	B1.G102-0769.2	G1020769
F 026 000 131	B1.G102-0292.2	G1020292	0 4863 784	B1.G120-5203.2	G1205203	6802 0256AA	B1.G120-5230.2	G1205230
F 026 000 132	B1.G102-0326.2	G1020326	0 5011 630AA	B1.G120-5203.2	G1205203	6802 0494AB	B1.G120-5241.2	G1205241
F 026 000 133	B1.G102-0345.2	G1020345	0 5012 651AA	B1.G120-5203.2	G1205203	6802 8671AA	B1.G120-5230.2	G1205230
F 026 000 133	B1.G102-0492.2	G1020492	0 5017 843AA	B1.G120-5215.2	G1205215	6803 5576AA	B1.G120-5241.2	G1205241
F 026 000 133	B1.G102-0549.2	G1020549	0 5018 208AA	B1.G120-5203.2	G1205203	K05191231AA	B1.G120-5241.2	G1205241
F 026 000 135	B1.G102-0097.2	G1020097	0 5066 427AA	B1.G120-5238.2	G1205238	K068020256AA	B1.G120-5230.2	G1205230
F 026 000 136	B1.G102-0015.2	G1020015	0 5071 948AA	B1.G120-5234.2	G1205234	K068028671AA	B1.G120-5230.2	G1205230
F 026 000 139	B1.G102-0219.2	G1020219	0 5072 216AA	B1.G120-5366.2	G1205366	K068035576AA	B1.G120-5241.2	G1205241
F 026 000 139	B1.G102-0323.2	G1020323	0 5083 071AA	B1.G120-5203.2	G1205203	K68020256AA	B1.G120-5230.2	G1205230
F 026 000 141	B1.G102-0026.2	G1020026	0 5083 853AA	B1.G120-5215.2	G1205215	K68020494AB	B1.G120-5241.2	G1205241
F 026 000 142	B1.G102-0201.2	G1020201	0 5098 063AA	B1.G225-0110.1	G2125110	K68028671AA	B1.G120-5230.2	G1205230
F 026 000 142	B1.G102-0489.2	G1020489	0 5098 065AA	B1.G209-0114.1	G2109114	K68035576AA	B1.G120-5241.2	G1205241
F 026 000 143	B1.G102-0196.2	G1020196	0 5098 066AA	B1.G209-0114.1	G2109114			
F 026 000 143	B1.G102-0197.2	G1020197	0 5103 550AA	B1.G102-0397.2	G1020397	<b>CITROEN</b>		
F 026 000 144	B1.G102-0196.2	G1020196	0 5103 550BB	B1.G102-0397.2	G1020397	16 070 832 80	B1.G102-0920.2	G1020920
F 026 000 144	B1.G102-0197.2	G1020197	0 5103 790AA	B1.G102-0891.2	G1020891	16 076 903 80	B1.G120-5241.2	G1205241
F 026 000 144	B1.G102-0274.2	G1020274	0 5114 424AA	B1.G120-5203.2	G1205203	16 076 904 80	B1.G120-5241.2	G1205241
F 026 000 145	B1.G102-0046.2	G1020046	0 5114 555AA	B1.G102-0401.2	G1020401	16 086 916 80	B1.G213-0184.1	G2113184
F 026 000 146	B1.G102-0022.2	G1020022	0 5126 300AA	B1.G102-0441.2	G1020441	4246 H9	B1.G220-0155.1	G2120155
F 026 000 148	B1.G102-0140.2	G1020140	0 5139 218AA	B1.G102-0401.2	G1020401	4246 J0	B1.G220-0180.1	G2120180
F 026 000 148	B1.G102-0184.2	G1020184	0 5139 902AA	B1.G102-0441.2	G1020441	4246 K3	B1.G224-0138.1	G2124138
F 026 000 151	B1.G102-0009.2	G1020009	0 5143 230AA	B1.G102-0683.2	G1020683	4246 L4	B1.G224-0127.1	G2124127
F 026 000 152	B1.G102-0026.2	G1020026	0 5143 633AA	B1.G102-0400.2	G1020400	4246 L8	B1.G226-0106.1	G2126106
F 026 000 154	B1.G102-0028.2	G1020028	0 5191 231AA	B1.G120-5241.2	G1205241	4246 R4	B1.G213-0184.1	G2113184
F 026 000 155	B1.G102-0271.2	G1020271	0 6800 6732AA	B1.G102-0769.2	G1020769	4246 R5	B1.G220-0133.1	G2120133
F 026 000 156	B1.G102-0213.2	G1020213	0 6800 6732AB	B1.G102-0769.2	G1020769	4246 R9	B1.G213-0185.1	G2113185
F 026 000 156	B1.G102-0299.2	G1020299	0 6802 0256AA	B1.G120-5230.2	G1205230	4246 W1	B1.G222-0194.1	G2122194
F 026 000 158	B1.G102-0184.2	G1020184	0 6802 0494AB	B1.G120-5241.2	G1205241	4246 W2	B1.G226-0120.1	G2126120
F 026 000 159	B1.G102-0246.2	G1020246	0 6802 8671AA	B1.G120-5230.2	G1205230	4246 W6	B1.G220-0133.1	G2120133
F 026 000 161	B1.G102-0015.2	G1020015	0 6803 5576AA	B1.G120-5241.2	G1205241	4246 X8	B1.G209-0137.1	G2109137
F 026 000 161	B1.G102-0258.2	G1020258	4762 669	B1.G120-5203.2	G1205203	4246 Y1	B1.G224-0127.1	G2124127
F 026 000 162	B1.G102-0332.2	G1020333	4863 784	B1.G120-5203.2	G1205203	4246 Y3	B1.G224-0138.1	G2124138
			5011 630AA	B1.G120-5203.2	G1205203	4246 Y7	B1.G216-0124.1	G2116124
			5012 651AA	B1.G120-5203.2	G1205203	4249 16	B1.G222-0194.1	G2122194
<b>CHEVROLET</b>			5017 843AA	B1.G120-5215.2	G1205215	4249 18	B1.G226-0120.1	G2126120
13237750	B1.G120-1143.2	G1201143	5018 208AA	B1.G120-5203.2	G1205203	4249 27	B1.G224-0127.1	G2124127
13237751	B1.G120-1145.2	G1201145	5066 427AA	B1.G120-5238.2	G1205238	4249 31	B1.G216-0124.1	G2116124
13300867	B1.G102-0953.2	G1020953	5071 948AA	B1.G120-5234.2	G1205234	4249 36	B1.G224-0138.1	G2124138
13301234	B1.G102-0928.2	G1020928	5072 216AA	B1.G120-5366.2	G1205366	4249 42	B1.G216-0123.1	G2116123
13319293	B1.G102-0953.2	G1020953	5083 071AA	B1.G120-5203.2	G1205203	4249 53	B1.G209-0137.1	G2109137
13319294	B1.G102-0953.2	G1020953	5083 853AA	B1.G120-5215.2	G1205215	4249 55	B1.G220-0180.1	G2120180
13411383	B1.G102-0953.2	G1020953	5098 063AA	B1.G225-0110.1	G2125110	4249 72	B1.G212-0162.1	G2112162
20789468	B1.G102-0979.2	G1020979	5098 065AA	B1.G209-0114.1	G2109114	4249 74	B1.G222-0197.1	G2122197
22799077	B1.G102-0928.2	G1020928	5098 066AA	B1.G209-0114.1	G2109114	4249 76	B1.G222-0147.1	G2122147
90121445	B1.G220-0115.1	G2120115	5103 550AA	B1.G102-0397.2	G1020397	4249 82	B1.G213-0184.1	G2113184
90511111	B1.G220-0115.1	G2120115	5103 550BB	B1.G102-0397.2	G1020397	4249 83	B1.G222-0194.1	G2122194
95459513	B1.G102-0981.2	G1020981						

# Cross reference list

Liste des correspondances / Tabella di conversione codici / Lista de comparação /

Lista porównawcza numerów / Porovnávací seznam čísel



CITROEN		CITROEN		CITROEN				
4249 84	B1.G226-0120.1	G2126120	4252 58	B1.G102-0686.2	G1020686	4254 61	B1.G102-0763.2	G1020763
4249 90	B1.G209-0137.1	G2109137	4252 74	B1.G102-0522.2	G1020522	4254 62	B1.G102-0872.2	G1020872
4249 94	B1.G220-0180.1	G2120180	4252 88	B1.G102-0602.2	G1020602	4254 63	B1.G102-0764.2	G1020764
4249 99	B1.G224-0127.1	G2124127	4252 89	B1.G102-0603.2	G1020603	4254 64	B1.G102-0873.2	G1020873
4249 C1	B1.G212-0162.1	G2112162	4252 90	B1.G102-0604.2	G1020604	4254 65	B1.G102-0790.2	G1020790
4249 F0	B1.G220-0133.1	G2120133	4252 91	B1.G102-0328.2	G1020328	4254 66	B1.G102-0291.2	G1020291
4249 F5	B1.G208-0106.1	G2108106	4252 94	B1.G102-0762.2	G1020762	4254 67	B1.G102-0492.2	G1020492
4249 G1	B1.G222-0194.1	G2122194	4253 23	B1.G102-0745.2	G1020745	4254 68	B1.G102-0518.2	G1020518
4249 H2	B1.G224-0138.1	G2124138	4253 25	B1.G102-0630.2	G1020630	4254 69	B1.G102-0730.2	G1020730
4249 J6	B1.G226-0120.1	G2126120	4253 28	B1.G102-0830.2	G1020830	4254 71	B1.G102-0735.2	G1020735
4249 K3	B1.G224-0127.1	G2124127	4253 31	B1.G102-0735.2	G1020735	4254 74	B1.G102-0830.2	G1020830
4249 K6	B1.G216-0123.1	G2116123	4253 34	B1.G102-0604.2	G1020604	4254 76	B1.G102-0630.2	G1020630
4249 K7	B1.G216-0124.1	G2116124	4253 44	B1.G102-0745.2	G1020745	4254 77	B1.G102-0792.2	G1020792
4249 L2	B1.G222-0197.1	G2122197	4253 45	B1.G102-0686.2	G1020686	4254 80	B1.G102-0762.2	G1020762
4249 L4	B1.G220-0155.1	G2120155	4253 46	B1.G102-0602.2	G1020602	4254 84	B1.G102-0513.2	G1020513
4251 10	B1.G102-0310.2	G1020310	4253 56	B1.G102-0763.2	G1020763	4254 85	B1.G102-0451.2	G1020451
4251 12	B1.G102-0291.2	G1020291	4253 58	B1.G102-0872.2	G1020872	4254 88	B1.G102-0745.2	G1020745
4251 17	B1.G102-0301.2	G1020301	4253 60	B1.G102-0730.2	G1020730	4254 89	B1.G102-0735.2	G1020735
4251 19	B1.G102-0302.2	G1020302	4253 61	B1.G102-0790.2	G1020790	4254 90	B1.G102-0522.2	G1020522
4251 26	B1.G102-0350.2	G1020350	4253 62	B1.G102-0792.2	G1020792	4254 91	B1.G102-0660.2	G1020660
4251 28	B1.G102-0443.2	G1020443	4253 64	B1.G102-0937.2	G1020937	4254 92	B1.G102-0614.2	G1020614
4251 37	B1.G102-0215.2	G1020215	4253 66	B1.G102-0937.2	G1020937	4254 96	B1.G102-0740.2	G1020740
4251 38	B1.G102-0293.2	G1020293	4253 68	B1.G102-0938.2	G1020938	4254 97	B1.G102-0938.2	G1020938
4251 39	B1.G102-0293.2	G1020293	4253 69	B1.G102-0686.2	G1020686	4254 A0	B1.G102-0762.2	G1020762
4251 44	B1.G102-0363.2	G1020363	4253 70	B1.G102-0735.2	G1020735	4254 A2	B1.G102-0937.2	G1020937
4251 46	B1.G102-0522.2	G1020522	4253 71	B1.G102-0799.2	G1020799	4254 A3	B1.G102-0762.2	G1020762
4251 47	B1.G102-0215.2	G1020215	4253 72	B1.G102-0687.2	G1020687	4254 C0	B1.G102-0790.2	G1020790
4251 50	B1.G102-0350.2	G1020350	4253 74	B1.G102-0764.2	G1020764	4254 C8	B1.G120-1224.2	G1201224
4251 55	B1.G102-0451.2	G1020451	4253 76	B1.G102-0873.2	G1020873	91 508 338	B1.G210-0187.1	G2110187
4251 56	B1.G102-0328.2	G1020328	4253 80	B1.G102-0570.2	G1020570	91 517 695	B1.G220-0132.1	G2120132
4251 69	B1.G102-0497.2	G1020497	4253 84	B1.G102-0686.2	G1020686	95 027 199	B1.G208-0107.1	G2108107
4251 70	B1.G102-0293.2	G1020293	4253 91	B1.G120-5230.2	G1205230	95 616 818	B1.G102-0213.2	G1020213
4251 83	B1.G102-0329.2	G1020329	4253 99	B1.G102-0630.2	G1020630	95 619 549	B1.G102-0269.2	G1020269
4251 92	B1.G102-0497.2	G1020497	4254 03	B1.G102-0893.2	G1020893	95 619 550	B1.G102-0275.2	G1020275
4251 97	B1.G102-0522.2	G1020522	4254 04	B1.G102-0660.2	G1020660	95 624 970	B1.G102-0147.2	G1020147
4252 03	B1.G102-0513.2	G1020513	4254 07	B1.G102-0740.2	G1020740	95 632 048	B1.G220-0133.1	G2120133
4252 05	B1.G102-0497.2	G1020497	4254 09	B1.G102-0738.2	G1020738	95 646 300	B1.G102-0275.2	G1020275
4252 13	B1.G102-0570.2	G1020570	4254 11	B1.G102-0762.2	G1020762	95 647 611	B1.G102-0269.2	G1020269
4252 15	B1.G102-0602.2	G1020602	4254 13	B1.G102-0790.2	G1020790	95 647 733	B1.G102-0299.2	G1020299
4252 16	B1.G102-0603.2	G1020603	4254 15	B1.G102-0921.2	G1020921	95 650 936	B1.G102-0269.2	G1020269
4252 17	B1.G102-0604.2	G1020604	4254 20	B1.G102-0920.2	G1020920	95 650 937	B1.G102-0269.2	G1020269
4252 26	B1.G102-0482.2	G1020482	4254 24	B1.G102-0893.2	G1020893	95 650 938	B1.G102-0269.2	G1020269
4252 27	B1.G102-0483.2	G1020483	4254 25	B1.G102-0790.2	G1020790	95 654 085	B1.G102-0329.2	G1020329
4252 31	B1.G102-0514.2	G1020514	4254 28	B1.G102-0920.2	G1020920	95 658 617	B1.G102-0275.2	G1020275
4252 33	B1.G102-0549.2	G1020549	4254 29	B1.G102-0921.2	G1020921	95 659 340	B1.G102-0296.2	G1020296
4252 34	B1.G102-0570.2	G1020570	4254 32	B1.G102-0799.2	G1020799	95 659 341	B1.G102-0216.2	G1020216
4252 35	B1.G102-0735.2	G1020735	4254 46	B1.G102-0946.2	G1020946	95 659 353	B1.G102-0299.2	G1020299
4252 36	B1.G102-0686.2	G1020686	4254 48	B1.G120-5230.2	G1205230	95 659 616	B1.G102-0295.2	G1020295
4252 37	B1.G102-0687.2	G1020687	4254 51	B1.G102-0301.2	G1020301	95 659 642	B1.G102-0329.2	G1020329
4252 41	B1.G102-0492.2	G1020492	4254 52	B1.G102-0302.2	G1020302	95 661 747	B1.G220-0132.1	G2120132
4252 43	B1.G102-0516.2	G1020516	4254 53	B1.G102-0310.2	G1020310	95 661 748	B1.G210-0187.1	G2110187
4252 45	B1.G102-0517.2	G1020517	4254 54	B1.G102-0350.2	G1020350	95 661 749	B1.G208-0106.1	G2108106
4252 47	B1.G102-0518.2	G1020518	4254 55	B1.G102-0482.2	G1020482	95 661 810	B1.G208-0107.1	G2108107
4252 48	B1.G102-0602.2	G1020602	4254 56	B1.G102-0483.2	G1020483	95 661 871	B1.G102-0299.2	G1020299
4252 49	B1.G102-0603.2	G1020603	4254 57	B1.G102-0514.2	G1020514	95 666 970	B1.G102-0295.2	G1020295
4252 53	B1.G102-0614.2	G1020614	4254 58	B1.G102-0516.2	G1020516	95 666 971	B1.G102-0216.2	G1020216
4252 57	B1.G102-0522.2	G1020522	4254 59	B1.G102-0517.2	G1020517	95 666 973	B1.G102-0329.2	G1020329



# Cross reference list

Liste des correspondances / Tabella di conversione codici / Lista de comparação /



Lista porównawcza numerów / Porovnávací seznam čísel

CITROEN 		FERODO 		FERODO 	
95 667 764	B1.G102-0147.2 G1020147	DDF070	B1.G208-0104.1 G2108104	DDF1204	B1.G228-0132.1 G2128132
95 667 786	B1.G102-0328.2 G1020328	DDF1000	B1.G213-0184.1 G2113184	DDF1218	B1.G225-0145.1 G2125145
95 667 788	B1.G102-0329.2 G1020329	DDF1003	B1.G222-0152.1 G2122152	DDF122	B1.G209-0120.1 G2109120
95 667 809	B1.G220-0133.1 G2120133	DDF1006	B1.G222-0148.1 G2122148	DDF1220	B1.G222-0232.1 G2122232
96 012 770	B1.G208-0106.1 G2108106	DDF1012	B1.G212-0138.1 G2112138	DDF1221	B1.G225-0113.1 G2125113
96 070 525	B1.G210-0187.1 G2110187	DDF1013	B1.G222-0161.1 G2122161	DDF1222	B1.G225-0117.1 G2125117
<b>DACIA</b>		DDF1014	B1.G225-0115.1 G2125115	DDF1223	B1.G222-0210.1 G2122210
40 20 612 00R	B1.G222-0270.1 G2122270	DDF103	B1.G212-0106.1 G2112106	DDF1224	B1.G210-0277.1 G2110277
40 20 641 51R	B1.G224-0221.1 G2124221	DDF1033	B1.G210-0258.1 G2110258	DDF1225	B1.G225-0162.1 G2125162
41 06 021 92R	B1.G102-0501.2 G1020501	DDF1034	B1.G212-0144.1 G2112144	DDF1229	B1.G222-0238.1 G2122238
41 06 047 75R	B1.G102-0741.2 G1020741	DDF1041	B1.G224-0152.1 G2124152	DDF1232	B1.G210-0261.1 G2110261
41 06 084 81R	B1.G102-0741.2 G1020741	DDF1042	B1.G225-0131.1 G2125131	DDF1233	B1.G209-0124.1 G2109124
44 06 039 05R	B1.G120-1126.2 G1201126	DDF1043	B1.G210-0251.1 G2110251	DDF1236	B1.G225-0148.1 G2125148
60 01 547 619	B1.G102-0501.2 G1020501	DDF1044	B1.G210-0250.1 G2110250	DDF1237	B1.G228-0164.1 G2128164
60 01 547 683	B1.G212-0171.1 G2112171	DDF1058	B1.G207-0109.1 G2107109	DDF1238	B1.G230-0176.1 G2130176
60 01 547 684	B1.G212-0116.1 G2112116	DDF1063	B1.G224-0158.1 G2124158	DDF1252	B1.G228-0176.1 G2128176
60 01 547 911	B1.G102-0501.2 G1020501	DDF1066	B1.G222-0160.1 G2122160	DDF1253	B1.G230-0114.1 G2130114
60 01 548 578	B1.G221-0106.1 G2121106	DDF1072	B1.G222-0172.1 G2122172	DDF1258	B1.G208-0113.1 G2108113
60 01 549 211	B1.G212-0116.1 G2112116	DDF1073	B1.G219-0108.1 G2119108	DDF1261	B1.G225-0142.1 G2125142
77 01 206 339	B1.G221-0106.1 G2121106	DDF1076	B1.G213-0195.1 G2113195	DDF1263	B1.G228-0142.1 G2128142
77 01 208 252	B1.G212-0171.1 G2112171	DDF1082	B1.G225-0119.1 G2125119	DDF1268	B1.G218-0145.1 G2118145
77 01 208 265	B1.G102-0501.2 G1020501	DDF1084	B1.G218-0131.1 G2118131	DDF1272	B1.G212-0155.1 G2112155
77 01 208 422	B1.G102-0741.2 G1020741	DDF1085	B1.G232-0114.1 G2132114	DDF1276	B1.G212-0158.1 G2112158
77 01 209 164	B1.G102-0741.2 G1020741	DDF1096	B1.G221-0106.1 G2121106	DDF1277	B1.G230-0175.1 G2130175
77 01 209 639	B1.G102-0501.2 G1020501	DDF1101	B1.G224-0171.1 G2124171	DDF1279	B1.G220-0115.1 G2120115
77 01 210 142	B1.G102-0501.2 G1020501	DDF1102	B1.G224-0158.1 G2124158	DDF128	B1.G210-0178.1 G2110178
77 11 130 071	B1.G102-0501.2 G1020501	DDF1111	B1.G209-0136.1 G2109136	DDF1286	B1.G222-0211.1 G2122211
<b>DAEWOO</b>		DDF1118	B1.G225-0123.1 G2125123	DDF1288	B1.G212-0157.1 G2112157
90121445	B1.G220-0115.1 G2120115	DDF1120	B1.G232-0115.1 G2132115	DDF1291	B1.G225-0149.1 G2125149
96179110	B1.G224-0115.1 G2124115	DDF1121	B1.G228-0125.1 G2128125	DDF1294	B1.G225-0155.1 G2125155
96284392	B1.G213-0195.1 G2113195	DDF1123	B1.G224-0171.1 G2124171	DDF1304	B1.G222-0231.1 G2122231
96320531	B1.G213-0195.1 G2113195	DDF1124	B1.G224-0158.1 G2124158	DDF1305	B1.G225-0158.1 G2125158
11046948322	B1.G102-0317.2 G1020317	DDF1125	B1.G224-0161.1 G2124161	DDF1306	B1.G212-0169.1 G2112169
11046948372	B1.G102-0317.2 G1020317	DDF1126	B1.G212-0154.1 G2112154	DDF1307	B1.G210-0278.1 G2110278
11046952012	B1.G102-0258.2 G1020258	DDF1127	B1.G222-0204.1 G2122204	DDF1309	B1.G225-0155.1 G2125155
<b>DAIHATSU</b>		DDF1128	B1.G210-0271.1 G2110271	DDF1314	B1.G225-0155.1 G2125155
04465-0D050	B1.G102-0798.2 G1020798	DDF1129	B1.G211-0152.1 G2111152	DDF132	B1.G208-0107.1 G2108107
04465-B1120-000	B1.G120-1053.2 G1201053	DDF1130	B1.G220-0174.1 G2120174	DDF1361	B1.G210-0211.1 G2110211
04465-B1190-000	B1.G120-1053.2 G1201053	DDF1131	B1.G224-0166.1 G2124166	DDF137	B1.G210-0111.1 G2110111
04465-B1320-000	B1.G120-1053.2 G1201053	DDF1135	B1.G225-0110.1 G2125110	DDF1374	B1.G225-0198.1 G2125198
04466-0D010	B1.G102-0666.2 G1020666	DDF1140	B1.G222-0194.1 G2122194	DDF1383	B1.G210-0285.1 G2110285
42431-0D060	B1.G209-0142.1 G2109142	DDF1144	B1.G216-0124.1 G2116124	DDF141	B1.G212-0127.1 G2112127
43512-0D060	B1.G222-0240.1 G2122240	DDF1149	B1.G220-0175.1 G2120175	DDF141-1	B1.G212-0127.1 G2112127
<b>FERODO</b>		DDF1152	B1.G226-0120.1 G2126120	DDF1417	B1.G209-0139.1 G2109139
21938 20,40 41 5	B1.G102-0313.2 G1020313	DDF1154	B1.G222-0163.1 G2122163	DDF1420	B1.G211-0164.1 G2111164
23057 20,00 40 5	B1.G102-0550.2 G1020550	DDF1155	B1.G209-0133.1 G2109133	DDF1458	B1.G232-0153.1 G2132153
23070 16,75 42 4	B1.G102-0440.2 G1020440	DDF1156	B1.G225-0137.1 G2125137	DDF1497	B1.G211-0154.1 G2111154
23124 19,00 40 3	B1.G102-0451.2 G1020451	DDF116	B1.G213-0161.1 G2113161	DDF1500	B1.G210-0302.1 G2110302
DDF042	B1.G210-0151.1 G2110151	DDF1164	B1.G218-0137.1 G2118137	DDF151	B1.G220-0115.1 G2120115
DDF055	B1.G212-0116.1 G2112116	DDF1166	B1.G230-0113.1 G2130113	DDF1549	B1.G220-0204.1 G2120204
DDF059	B1.G210-0187.1 G2110187	DDF1170	B1.G224-0127.1 G2124127	DDF156	B1.G222-0145.1 G2122145
DDF066	B1.G210-0190.1 G2110190	DDF1171	B1.G224-0138.1 G2124138	DDF1567-1	B1.G228-0154.1 G2128154
DDF067	B1.G210-0209.1 G2110209	DDF1174	B1.G225-0138.1 G2125138	DDF1572	B1.G234-0100.1 G2134100
		DDF1178	B1.G209-0137.1 G2109137	DDF158	B1.G220-0125.1 G2120125
		DDF1179	B1.G220-0184.1 G2120184	DDF1587	B1.G222-0240.1 G2122240
		DDF1182	B1.G224-0169.1 G2124169	DDF1728-1	B1.G224-0221.1 G2124221
		DDF1201	B1.G222-0216.1 G2122216	DDF175	B1.G220-0123.1 G2120123

# Cross reference list

Liste des correspondances / Tabella di conversione codici / Lista de comparação /

Lista porównawcza numerów / Porovnávací seznam čísel



FERODO 	FERODO 	FERODO 			
DDF1784	B1.G212-0184.1 G2112184	DDF834	B1.G222-0159.1 G2122159	DRF205	B1.G213-0178.1 G2113178
DDF1895-1	B1.G210-0356.1 G2110356	DDF841	B1.G226-0106.1 G2126106	DRF206	B1.G224-0115.1 G2124115
DDF192	B1.G220-0133.1 G2120133	DDF842	B1.G220-0155.1 G2120155	DRF207	B1.G220-0128.1 G2120128
DDF205	B1.G213-0178.1 G2113178	DDF845	B1.G212-0141.1 G2112141	DRF208	B1.G210-0196.1 G2110196
DDF206	B1.G224-0115.1 G2124115	DDF846	B1.G225-0114.1 G2125114	DRF214	B1.G220-0132.1 G2120132
DDF207	B1.G220-0128.1 G2120128	DDF847	B1.G210-0223.1 G2110223	DRF220	B1.G222-0147.1 G2122147
DDF208	B1.G210-0196.1 G2110196	DDF848	B1.G224-0131.1 G2124131	DRF244	B1.G208-0106.1 G2108106
DDF214	B1.G220-0132.1 G2120132	DDF869	B1.G210-0230.1 G2110230	DRF248	B1.G212-0126.1 G2112126
DDF220	B1.G222-0147.1 G2122147	DDF875	B1.G213-0182.1 G2113182	DRF249	B1.G210-0202.1 G2110202
DDF224	B1.G209-0114.1 G2109114	DDF886	B1.G210-0229.1 G2110229	DRF258	B1.G222-0115.1 G2122115
DDF224C-1	B1.G209-0114.1 G2109114	DDF887	B1.G220-0147.1 G2120147	DRF281	B1.G210-0115.1 G2110115
DDF244	B1.G208-0106.1 G2108106	DDF927	B1.G222-0151.1 G2122151	DRF321	B1.G210-0201.1 G2110201
DDF248	B1.G212-0126.1 G2112126	DDF928	B1.G222-0150.1 G2122150	DRF324	B1.G215-0105.1 G2115105
DDF249	B1.G210-0202.1 G2110202	DDF929	B1.G209-0123.1 G2109123	DRF328	B1.G220-0140.1 G2120140
DDF258	B1.G222-0115.1 G2122115	DDF930	B1.G225-0113.1 G2125113	DRF334	B1.G208-0109.1 G2108109
DDF267	B1.G210-0215.1 G2110215	DDF963	B1.G210-0217.1 G2110217	DRF364	B1.G224-0120.1 G2124120
DDF281	B1.G210-0115.1 G2110115	DDF965	B1.G210-0211.1 G2110211	DRF479	B1.G220-0146.1 G2120146
DDF320	B1.G225-0105.1 G2125105	DDF992	B1.G225-0124.1 G2125124	DRF492	B1.G221-0105.1 G2121105
DDF321	B1.G210-0201.1 G2110201	DDF995	B1.G213-0185.1 G2113185	DRF521	B1.G220-0142.1 G2120142
DDF324	B1.G215-0105.1 G2115105	DF1046	B1.G228-0203.1 G2128203	DRF620	B1.G225-0124.1 G2125124
DDF328	B1.G220-0140.1 G2120140	DRF042	B1.G210-0151.1 G2110151	DRF752	B1.G208-0109.1 G2108109
DDF333	B1.G208-0108.1 G2108108	DRF055	B1.G212-0116.1 G2112116	DRF759	B1.G213-0181.1 G2113181
DDF334	B1.G208-0109.1 G2108109	DRF059	B1.G210-0187.1 G2110187	DRF762	B1.G222-0197.1 G2122197
DDF364	B1.G224-0120.1 G2124120	DRF066	B1.G210-0190.1 G2110190	DRF766	B1.G220-0147.1 G2120147
DDF369	B1.G224-0171.1 G2124171	DRF067	B1.G210-0209.1 G2110209	DRF795	B1.G210-0232.1 G2110232
DDF435	B1.G210-0213.1 G2110213	DRF070	B1.G208-0104.1 G2108104	DRF798	B1.G221-0106.1 G2121106
DDF442	B1.G212-0137.1 G2112137	DRF1003	B1.G222-0152.1 G2122152	DRF810	B1.G225-0119.1 G2125119
DDF445	B1.G208-0108.1 G2108108	DRF1006	B1.G222-0148.1 G2122148	DRF812	B1.G218-0106.1 G2118106
DDF445	B1.G208-0109.1 G2108109	DRF1014	B1.G225-0115.1 G2125115	DRF817	B1.G225-0110.1 G2125110
DDF468	B1.G210-0212.1 G2110212	DRF103	B1.G212-0106.1 G2112106	DRF830	B1.G210-0210.1 G2110210
DDF479	B1.G220-0146.1 G2120146	DRF1033	B1.G210-0258.1 G2110258	DRF831	B1.G219-0107.1 G2119107
DDF492	B1.G221-0105.1 G2121105	DRF1066	B1.G222-0160.1 G2122160	DRF834	B1.G222-0159.1 G2122159
DDF521	B1.G220-0142.1 G2120142	DRF1072	B1.G222-0172.1 G2122172	DRF841	B1.G226-0106.1 G2126106
DDF528	B1.G228-0164.1 G2128164	DRF1073	B1.G219-0108.1 G2119108	DRF845	B1.G212-0141.1 G2112141
DDF539	B1.G209-0120.1 G2109120	DRF1082	B1.G225-0119.1 G2125119	DRF927	B1.G222-0151.1 G2122151
DDF543	B1.G210-0261.1 G2110261	DRF1096	B1.G221-0106.1 G2121106	DRF928	B1.G222-0150.1 G2122150
DDF620	B1.G225-0124.1 G2125124	DRF1118	B1.G225-0123.1 G2125123	DRF929	B1.G209-0123.1 G2109123
DDF698	B1.G212-0131.1 G2112131	DRF1123	B1.G224-0171.1 G2124171	DRF995	B1.G213-0185.1 G2113185
DDF752	B1.G208-0109.1 G2108109	DRF1124	B1.G224-0158.1 G2124158	FCP105S	B1.G102-0097.2 G1020097
DDF759	B1.G213-0181.1 G2113181	DRF1127	B1.G222-0204.1 G2122204	FCP1063S	B1.G102-0363.2 G1020363
DDF762	B1.G222-0197.1 G2122197	DRF1128	B1.G210-0271.1 G2110271	FCP1081S	B1.G102-0334.2 G1020334
DDF766	B1.G220-0147.1 G2120147	DRF1140	B1.G222-0194.1 G2122194	FCP1082S	B1.G102-0332.2 G1020333
DDF767	B1.G224-0127.1 G2124127	DRF1149	B1.G220-0175.1 G2120175	FCP1094S	B1.G102-0331.2 G1020331
DDF768	B1.G224-0138.1 G2124138	DRF1154	B1.G222-0163.1 G2122163	FCP1101S	B1.G102-0408.2 G1020408
DDF795	B1.G210-0232.1 G2110232	DRF1155	B1.G209-0133.1 G2109133	FCP206S	B1.G102-0334.2 G1020334
DDF796	B1.G222-0161.1 G2122161	DRF1156	B1.G225-0137.1 G2125137	FCP370S	B1.G102-0140.2 G1020140
DDF798	B1.G221-0106.1 G2121106	DRF116	B1.G213-0161.1 G2113161	FCP385S	B1.G102-0025.2 G1020025
DDF809	B1.G210-0115.1 G2110115	DRF1174	B1.G225-0138.1 G2125138	FCP392S	B1.G102-0010.2 G1020010
DDF810	B1.G225-0119.1 G2125119	DRF128	B1.G210-0178.1 G2110178	FCP393S	B1.G102-0214.2 G1020214
DDF812	B1.G218-0106.1 G2118106	DRF132	B1.G208-0107.1 G2108107	FCP406S	B1.G102-0326.2 G1020326
DDF814	B1.G210-0225.1 G2110225	DRF137	B1.G210-0111.1 G2110111	FCP409S	B1.G102-0236.2 G1020236
DDF817	B1.G225-0110.1 G2125110	DRF141	B1.G212-0127.1 G2112127	FCP415S	B1.G102-0044.2 G1020044
DDF819	B1.G209-0114.1 G2109114	DRF151	B1.G220-0115.1 G2120115	FCP434S	B1.G102-0213.2 G1020213
DDF819-1	B1.G209-0114.1 G2109114	DRF156	B1.G222-0145.1 G2122145	FCP524S	B1.G102-0184.2 G1020184
DDF819C-1	B1.G209-0114.1 G2109114	DRF158	B1.G220-0125.1 G2120125	FCP535S	B1.G102-0269.2 G1020269
DDF830	B1.G210-0210.1 G2110210	DRF175	B1.G220-0123.1 G2120123	FCP535S	B1.G102-0275.2 G1020275
DDF831	B1.G219-0107.1 G2119107	DRF192	B1.G220-0133.1 G2120133	FCP541S	B1.G102-0201.2 G1020201



# Cross reference list

Liste des correspondances / Tabella di conversione codici / Lista de comparação /



Lista porównawcza numerów / Porovnávací seznam čísel

FERODO 	FERODO 	FERODO 
FCP578S	B1.G102-0308.2 G1020308	FDB1094 B1.G102-0331.2 G1020331
FCP584S	B1.G102-0258.2 G1020258	FDB1095 B1.G102-0458.2 G1020458
FCP590S	B1.G102-0311.2 G1020311	FDB1099 B1.G120-5203.2 G1205203
FCP617S	B1.G102-0423.2 G1020423	FDB1101 B1.G102-0408.2 G1020408
FCP725S	B1.G102-0608.2 G1020608	FDB1109 B1.G102-0443.2 G1020443
FCP732S	B1.G102-0317.2 G1020317	FDB1112 B1.G102-0451.2 G1020451
FCP774S	B1.G102-0273.2 G1020273	FDB1113 B1.G102-0236.2 G1020236
FCP775S	B1.G102-0274.2 G1020274	FDB1117 B1.G102-0271.2 G1020271
FCP779S	B1.G102-0474.2 G1020474	FDB1124 B1.G102-0459.2 G1020459
FCP845S	B1.G102-0501.2 G1020501	FDB113 B1.G102-0065.2 G1020065
FCP850S	B1.G102-0316.2 G1020316	FDB1131 B1.G102-0315.2 G1020315
FCP857S	B1.G102-0367.2 G1020367	FDB1132 B1.G102-0658.2 G1020658
FCP876S	B1.G102-0292.2 G1020292	FDB1134 B1.G102-0392.2 G1020392
FCP876S	B1.G102-0293.2 G1020293	FDB1135 B1.G102-0497.2 G1020497
FCP881S	B1.G102-0323.2 G1020323	FDB1160 B1.G102-0351.2 G1020351
FCP995S	B1.G102-0359.2 G1020359	FDB1162 B1.G102-0540.2 G1020540
FCP998S	B1.G102-0372.2 G1020372	FDB1163 B1.G102-0419.2 G1020419
FCR153A	B1.G222-0161.1 G2122161	FDB1167 B1.G102-0312.2 G1020312
FCR228A	B1.G222-0161.1 G2122161	FDB1168 B1.G102-0293.2 G1020293
FCR310A	B1.G228-0203.1 G2128203	FDB1276 B1.G102-0423.2 G1020423
FCV1043	B1.G102-0891.2 G1020891	FDB1285 B1.G102-0956.2 G1020956
FDB1000	B1.G102-0310.2 G1020310	FDB1288 B1.G102-0390.2 G1020390
FDB1001	B1.G102-0683.2 G1020683	FDB1289 B1.G102-0421.2 G1020421
FDB1002	B1.G102-0350.2 G1020350	FDB1293 B1.G102-0542.2 G1020542
FDB1003	B1.G102-0291.2 G1020291	FDB1294 B1.G102-0554.2 G1020554
FDB1021	B1.G120-5404.2 G1205404	FDB1295 B1.G102-0550.2 G1020550
FDB1038	B1.G102-0742.2 G1020742	FDB1299 B1.G102-0360.2 G1020360
FDB1039	B1.G102-0396.2 G1020396	FDB1299 B1.G102-0473.2 G1020473
FDB1040	B1.G102-0340.2 G1020340	FDB1300 B1.G102-0608.2 G1020608
FDB1040B	B1.G102-0340.2 G1020340	FDB1301 B1.G102-0316.2 G1020316
FDB1044	B1.G102-0395.2 G1020395	FDB1303 B1.G102-0440.2 G1020440
FDB1045	B1.G102-0397.2 G1020397	FDB1303 B1.G120-1272.2 G1201272
FDB1049	B1.G102-0398.2 G1020398	FDB1304 B1.G102-0582.2 G1020582
FDB105	B1.G102-0097.2 G1020097	FDB1304A B1.G102-0582.2 G1020582
FDB1050	B1.G102-0401.2 G1020401	FDB1305 B1.G102-0584.2 G1020584
FDB1050	B1.G102-0776.2 G1020776	FDB1306 B1.G102-0583.2 G1020583
FDB1052	B1.G102-0360.2 G1020360	FDB1308 B1.G102-0883.2 G1020883
FDB1054	B1.G102-0355.2 G1020355	FDB1310 B1.G102-0422.2 G1020422
FDB1055	B1.G102-0312.2 G1020312	FDB1311 B1.G102-0422.2 G1020422
FDB1056	B1.G102-0342.2 G1020342	FDB1312 B1.G102-0444.2 G1020444
FDB1056B	B1.G102-0342.2 G1020342	FDB1318 B1.G102-0505.2 G1020505
FDB106	B1.G102-0065.2 G1020065	FDB1318B B1.G102-0505.2 G1020505
FDB1062	B1.G102-0362.2 G1020362	FDB1319 B1.G102-0507.2 G1020507
FDB1063	B1.G102-0363.2 G1020363	FDB1319B B1.G102-0507.2 G1020507
FDB1066	B1.G102-0305.2 G1020305	FDB1322 B1.G102-0442.2 G1020442
FDB1067	B1.G102-0258.2 G1020258	FDB1323 B1.G102-0313.2 G1020313
FDB1068	B1.G102-0403.2 G1020403	FDB1324 B1.G102-0568.2 G1020568
FDB1071	B1.G102-0344.2 G1020344	FDB1338 B1.G102-0617.2 G1020617
FDB1072	B1.G102-0344.2 G1020344	FDB1339 B1.G102-0618.2 G1020618
FDB1073	B1.G102-0411.2 G1020411	FDB1349 B1.G102-0568.2 G1020568
FDB1075	B1.G102-0415.2 G1020415	FDB1356 B1.G102-0615.2 G1020615
FDB1081	B1.G102-0334.2 G1020334	FDB1357 B1.G102-0440.2 G1020440
FDB1082	B1.G102-0332.2 G1020333	FDB1358 B1.G102-0544.2 G1020544
FDB1083	B1.G102-0492.2 G1020492	FDB1370 B1.G102-0513.2 G1020513
FDB1083	B1.G102-0549.2 G1020549	FDB1376 B1.G102-0448.2 G1020448
FDB1085	B1.G102-0326.2 G1020326	FDB1380 B1.G102-0563.2 G1020563
FDB1093	B1.G102-0457.2 G1020457	FDB1381 B1.G102-0597.2 G1020597
		FDB1382 B1.G102-0578.2 G1020578
		FDB1383 B1.G102-0480.2 G1020480
		FDB1384 B1.G102-0537.2 G1020537
		FDB1392 B1.G102-0714.2 G1020714
		FDB1393 B1.G102-0467.2 G1020467
		FDB1394 B1.G102-0519.2 G1020519
		FDB1396 B1.G102-0482.2 G1020482
		FDB1397 B1.G102-0483.2 G1020483
		FDB1398 B1.G102-0463.2 G1020463
		FDB1407 B1.G102-0644.2 G1020644
		FDB1411 B1.G102-0602.2 G1020602
		FDB1412 B1.G102-0603.2 G1020603
		FDB1413 B1.G102-0604.2 G1020604
		FDB1414 B1.G102-0632.2 G1020632
		FDB1415 B1.G102-0487.2 G1020487
		FDB1416 B1.G102-0563.2 G1020563
		FDB1419 B1.G102-0732.2 G1020732
		FDB1420 B1.G102-0569.2 G1020569
		FDB1423 B1.G102-0605.2 G1020605
		FDB1424 B1.G102-0545.2 G1020545
		FDB1425 B1.G102-0562.2 G1020562
		FDB1426 B1.G102-0574.2 G1020574
		FDB1428 B1.G102-0924.2 G1020924
		FDB1429 B1.G102-0925.2 G1020925
		FDB1440 B1.G102-0576.2 G1020576
		FDB1441 B1.G102-0547.2 G1020547
		FDB1442 B1.G120-5215.2 G1205215
		FDB1444 B1.G120-5344.2 G1205344
		FDB1451 B1.G102-0511.2 G1020511
		FDB1452 B1.G102-0624.2 G1020624
		FDB1453 B1.G102-0627.2 G1020627
		FDB1460 B1.G102-0698.2 G1020698
		FDB1461 B1.G102-0595.2 G1020595
		FDB1463 B1.G102-0512.2 G1020512
		FDB1466 B1.G102-0740.2 G1020740
		FDB1467 B1.G102-0503.2 G1020503
		FDB1467 B1.G120-1225.2 G1201225
		FDB1468 B1.G102-0504.2 G1020504
		FDB1469 B1.G102-0515.2 G1020515
		FDB1471 B1.G102-0572.2 G1020572
		FDB1472 B1.G102-0560.2 G1020560
		FDB1473 B1.G102-0901.2 G1020901
		FDB1474 B1.G120-5366.2 G1205366
		FDB1475 B1.G120-5234.2 G1205234
		FDB1476 B1.G102-0614.2 G1020614
		FDB1476 B1.G102-0735.2 G1020735
		FDB1477 B1.G102-0570.2 G1020570
		FDB1478 B1.G102-0516.2 G1020516
		FDB1479 B1.G102-0517.2 G1020517
		FDB1480 B1.G102-0518.2 G1020518
		FDB1481 B1.G102-0564.2 G1020564
		FDB1482 B1.G102-0654.2 G1020654
		FDB1483 B1.G102-0367.2 G1020367
		FDB1484 B1.G102-0527.2 G1020527
		FDB1491 B1.G102-0489.2 G1020489
		FDB1492 B1.G102-0533.2 G1020533
		FDB1493 B1.G102-0751.2 G1020751

# Cross reference list

Liste des correspondances / Tabella di conversione codici / Lista de comparação /



Lista porównawcza numerów / Porovnávací seznam čísel

FERODO 	FERODO 	FERODO 	
FDB1493	B1.G102-0752.2 G1020752	FDB1859	B1.G120-1013.2 G1201013
FDB1494	B1.G102-0752.2 G1020752	FDB1862	B1.G120-1014.2 G1201014
FDB1496	B1.G102-0557.2 G1020557	FDB1865	B1.G102-0867.2 G1020867
FDB1497	B1.G102-0580.2 G1020580	FDB1866	B1.G102-0871.2 G1020871
FDB1499	B1.G102-0646.2 G1020646	FDB1867	B1.G102-0316.2 G1020316
FDB1500	B1.G102-0648.2 G1020648	FDB1869	B1.G120-1002.2 G1201002
FDB1512	B1.G102-0575.2 G1020575	FDB1875	B1.G102-0774.2 G1020774
FDB1513	B1.G102-0478.2 G1020478	FDB1877	B1.G120-1010.2 G1201010
FDB1515	B1.G102-0633.2 G1020633	FDB1878	B1.G120-1011.2 G1201011
FDB1516	B1.G102-0529.2 G1020529	FDB1881	B1.G120-1029.2 G1201029
FDB1518	B1.G102-0534.2 G1020534	FDB1883	B1.G102-0746.2 G1020746
FDB1519	B1.G102-0524.2 G1020524	FDB1885	B1.G102-0625.2 G1020625
FDB1520	B1.G102-0650.2 G1020650	FDB1890	B1.G102-0798.2 G1020798
FDB1521	B1.G102-0610.2 G1020610	FDB1891	B1.G120-1065.2 G1201065
FDB1526	B1.G102-0652.2 G1020652	FDB1892	B1.G120-1022.2 G1201022
FDB1526	B1.G102-0985.2 G1020985	FDB1897	B1.G102-0889.2 G1020889
FDB1534	B1.G102-0591.2 G1020591	FDB1898	B1.G120-1009.2 G1201009
FDB1535	B1.G102-0642.2 G1020642	FDB1907	B1.G102-0659.2 G1020659
FDB1540	B1.G102-0470.2 G1020470	FDB1917	B1.G102-0786.2 G1020786
FDB1541	B1.G102-0548.2 G1020548	FDB1918	B1.G102-0787.2 G1020787
FDB1542	B1.G102-0686.2 G1020686	FDB1919	B1.G102-0833.2 G1020833
FDB1543	B1.G102-0687.2 G1020687	FDB1920	B1.G102-0858.2 G1020858
FDB1544	B1.G102-0685.2 G1020685	FDB1931	B1.G102-0727.2 G1020727
FDB1556	B1.G102-0514.2 G1020514	FDB1933	B1.G120-1135.2 G1201135
FDB1573	B1.G102-0712.2 G1020712	FDB1934	B1.G102-0979.2 G1020979
FDB1574	B1.G102-0713.2 G1020713	FDB1935	B1.G102-0981.2 G1020981
FDB1576	B1.G120-5238.2 G1205238	FDB1944	B1.G102-0951.2 G1020951
FDB1581	B1.G102-0573.2 G1020573	FDB1945	B1.G102-0952.2 G1020952
FDB1582	B1.G102-0573.2 G1020573	FDB1946	B1.G102-0737.2 G1020737
FDB1593	B1.G102-0661.2 G1020661	FDB1955	B1.G120-1033.2 G1201033
FDB1594	B1.G102-0622.2 G1020622	FDB1956	B1.G120-1035.2 G1201035
FDB1599	B1.G102-0513.2 G1020513	FDB1971	B1.G102-0790.2 G1020790
FDB1604	B1.G120-5230.2 G1205230	FDB1972	B1.G102-0792.2 G1020792
FDB1617	B1.G102-0538.2 G1020538	FDB1973	B1.G102-0799.2 G1020799
FDB1620	B1.G120-5242.2 G1205242	FDB1974	B1.G102-0794.2 G1020794
FDB1621	B1.G120-5241.2 G1205241	FDB1976	B1.G102-0896.2 G1020896
FDB1625	B1.G102-0709.2 G1020709	FDB1978	B1.G102-0933.2 G1020933
FDB1626	B1.G102-0710.2 G1020710	FDB1979	B1.G102-0935.2 G1020935
FDB1627	B1.G102-0711.2 G1020711	FDB1985	B1.G102-0714.2 G1020714
FDB1628	B1.G102-0634.2 G1020634	FDB1992	B1.G120-5230.2 G1205230
FDB1629	B1.G102-0754.2 G1020754	FDB1998	B1.G102-0785.2 G1020785
FDB1630	B1.G102-0621.2 G1020621	FDB206	B1.G102-0334.2 G1020334
FDB1631	B1.G102-0696.2 G1020696	FDB222	B1.G102-0246.2 G1020246
FDB1634	B1.G102-0409.2 G1020409	FDB287	B1.G102-0147.2 G1020147
FDB1635	B1.G102-0463.2 G1020463	FDB328	B1.G102-0022.2 G1020022
FDB1636	B1.G102-0682.2 G1020682	FDB343	B1.G102-0196.2 G1020196
FDB1637	B1.G102-0755.2 G1020755	FDB343	B1.G102-0197.2 G1020197
FDB1639	B1.G120-5418.2 G1205418	FDB346	B1.G102-0141.2 G1020141
FDB1640	B1.G102-0765.2 G1020765	FDB351	B1.G102-0141.2 G1020141
FDB1641	B1.G102-0680.2 G1020680	FDB351B	B1.G102-0141.2 G1020141
FDB1645	B1.G102-0566.2 G1020566	FDB370	B1.G102-0140.2 G1020140
FDB1648	B1.G102-0662.2 G1020662	FDB370B	B1.G102-0140.2 G1020140
FDB1649	B1.G102-0663.2 G1020663	FDB372	B1.G102-0721.2 G1020721
FDB1651	B1.G102-0484.2 G1020484	FDB375	B1.G102-0015.2 G1020015
FDB1652	B1.G102-0613.2 G1020613	FDB385	B1.G102-0025.2 G1020025
FDB1654	B1.G102-0593.2 G1020593	FDB392	B1.G102-0010.2 G1020010
FDB1655	B1.G102-0758.2 G1020758	FDB393	B1.G102-0214.2 G1020214

# Cross reference list

Liste des correspondances / Tabella di conversione codici / Lista de comparação /



Lista porównawcza numerów / Porovnávací seznam čísel

FERODO		FERODO		FERODO				
FDB393A	B1.G102-0214.2	G1020214	FDB4236	B1.G102-0714.2	G1020714	FDB767	B1.G102-0265.2	G1020265
FDB393C	B1.G102-0214.2	G1020214	FDB4237	B1.G102-0900.2	G1020900	FDB772	B1.G102-0290.2	G1020290
FDB398	B1.G102-0028.2	G1020028	FDB4250	B1.G102-0921.2	G1020921	FDB774	B1.G102-0273.2	G1020273
FDB4003	B1.G102-0859.2	G1020859	FDB4252	B1.G120-1148.2	G1201148	FDB774C	B1.G102-0273.2	G1020273
FDB4004	B1.G102-0920.2	G1020920	FDB4256	B1.G102-0876.2	G1020876	FDB774D	B1.G102-0273.2	G1020273
FDB4037	B1.G102-0825.2	G1020825	FDB4260	B1.G102-0920.2	G1020920	FDB775	B1.G102-0274.2	G1020274
FDB4041	B1.G102-0666.2	G1020666	FDB4263	B1.G102-0953.2	G1020953	FDB775C	B1.G102-0274.2	G1020274
FDB4042	B1.G102-0975.2	G1020975	FDB4264	B1.G102-0928.2	G1020928	FDB775D	B1.G102-0274.2	G1020274
FDB4044	B1.G102-0983.2	G1020983	FDB4265	B1.G102-0953.2	G1020953	FDB776	B1.G102-0722.2	G1020722
FDB4045	B1.G102-0823.2	G1020823	FDB4275	B1.G120-1209.2	G1201209	FDB779	B1.G102-0474.2	G1020474
FDB4046	B1.G102-0988.2	G1020988	FDB4278	B1.G120-1147.2	G1201147	FDB785	B1.G102-0304.2	G1020304
FDB4048	B1.G102-0768.2	G1020768	FDB4289	B1.G102-0776.2	G1020776	FDB799	B1.G102-0400.2	G1020400
FDB4050	B1.G120-1004.2	G1201004	FDB4319	B1.G102-0622.2	G1020622	FDB845	B1.G102-0501.2	G1020501
FDB4051	B1.G102-0866.2	G1020866	FDB4321	B1.G102-0567.2	G1020567	FDB845B	B1.G102-0501.2	G1020501
FDB4052	B1.G102-0806.2	G1020806	FDB4335	B1.G102-0975.2	G1020975	FDB845F	B1.G102-0501.2	G1020501
FDB4055	B1.G102-0877.2	G1020877	FDB434	B1.G102-0299.2	G1020299	FDB850	B1.G102-0316.2	G1020316
FDB4056	B1.G120-1066.2	G1201066	FDB4383	B1.G102-0844.2	G1020844	FDB853	B1.G102-0197.2	G1020197
FDB4057	B1.G102-0992.2	G1020992	FDB4388	B1.G120-5241.2	G1205241	FDB854	B1.G102-0337.2	G1020337
FDB4058	B1.G102-0993.2	G1020993	FDB440	B1.G102-0219.2	G1020219	FDB857	B1.G102-0367.2	G1020367
FDB406	B1.G102-0326.2	G1020326	FDB455	B1.G102-0213.2	G1020213	FDB874	B1.G102-0328.2	G1020328
FDB4060	B1.G120-1085.2	G1201085	FDB524	B1.G102-0184.2	G1020184	FDB876	B1.G102-0292.2	G1020292
FDB4064	B1.G120-1079.2	G1201079	FDB525	B1.G102-0271.2	G1020271	FDB877	B1.G102-0777.2	G1020777
FDB4065	B1.G102-0999.2	G1020999	FDB535	B1.G102-0269.2	G1020269	FDB878	B1.G102-0327.2	G1020327
FDB4067	B1.G102-0803.2	G1020803	FDB535	B1.G102-0275.2	G1020275	FDB881	B1.G102-0323.2	G1020323
FDB4080	B1.G102-0856.2	G1020856	FDB537	B1.G102-0219.2	G1020219	FDB884	B1.G102-0320.2	G1020320
FDB4081	B1.G102-0974.2	G1020974	FDB541	B1.G102-0201.2	G1020201	FDB901	B1.G102-0369.2	G1020369
FDB409	B1.G102-0236.2	G1020236	FDB541	B1.G102-0345.2	G1020345	FDB912	B1.G102-0389.2	G1020389
FDB4110	B1.G120-1053.2	G1201053	FDB558	B1.G102-0216.2	G1020216	FDB913	B1.G102-0886.2	G1020886
FDB4136	B1.G102-0994.2	G1020994	FDB558	B1.G102-0522.2	G1020522	FDB925	B1.G102-0298.2	G1020298
FDB415	B1.G102-0044.2	G1020044	FDB577	B1.G102-0474.2	G1020474	FDB925B	B1.G102-0298.2	G1020298
FDB4160	B1.G102-0893.2	G1020893	FDB578	B1.G102-0308.2	G1020308	FDB954	B1.G102-0197.2	G1020197
FDB4176	B1.G102-0633.2	G1020633	FDB579	B1.G102-0026.2	G1020026	FDB967	B1.G102-0301.2	G1020301
FDB4177	B1.G120-1029.2	G1201029	FDB584	B1.G102-0258.2	G1020258	FDB968	B1.G102-0302.2	G1020302
FDB4178	B1.G102-0676.2	G1020676	FDB586	B1.G102-0272.2	G1020272	FDB969	B1.G102-0379.2	G1020379
FDB4179	B1.G120-1053.2	G1201053	FDB589	B1.G102-0332.2	G1020332	FDB970	B1.G102-0347.2	G1020347
FDB4180	B1.G120-1126.2	G1201126	FDB590	B1.G102-0311.2	G1020311	FDB973	B1.G102-0271.2	G1020271
FDB4181	B1.G102-0834.2	G1020834	FDB615	B1.G102-0329.2	G1020329	FDB979	B1.G102-0046.2	G1020046
FDB4183	B1.G102-0920.2	G1020920	FDB617	B1.G102-0423.2	G1020423	FDB995	B1.G102-0359.2	G1020359
FDB4185	B1.G102-0875.2	G1020875	FDB619	B1.G102-0373.2	G1020373	FDB997	B1.G102-0368.2	G1020368
FDB4186	B1.G102-0874.2	G1020874	FDB644	B1.G102-0339.2	G1020339	FDB998	B1.G102-0372.2	G1020372
FDB4188	B1.G102-0650.2	G1020650	FDB669	B1.G102-0257.2	G1020257	FDS1040	B1.G102-0340.2	G1020340
FDB419	B1.G102-0009.2	G1020009	FDB676	B1.G102-0955.2	G1020955	FDS1049	B1.G102-0398.2	G1020398
FDB4190	B1.G120-1005.2	G1201005	FDB681	B1.G102-0956.2	G1020956	FDS1050	B1.G102-0401.2	G1020401
FDB4191	B1.G102-0939.2	G1020939	FDB687	B1.G102-0299.2	G1020299	FDS1052	B1.G102-0360.2	G1020360
FDB4192	B1.G102-0734.2	G1020734	FDB700	B1.G102-0617.2	G1020617	FDS1056	B1.G102-0342.2	G1020342
FDB4199	B1.G102-0934.2	G1020934	FDB701	B1.G102-0618.2	G1020618	FDS1063	B1.G102-0363.2	G1020363
FDB4207	B1.G120-1143.2	G1201143	FDB719	B1.G102-0295.2	G1020295	FDS1067	B1.G102-0258.2	G1020258
FDB4208	B1.G120-1145.2	G1201145	FDB72	B1.G102-0065.2	G1020065	FDS1068	B1.G102-0403.2	G1020403
FDB4209	B1.G120-1149.2	G1201149	FDB722	B1.G102-0315.2	G1020315	FDS1072	B1.G102-0344.2	G1020344
FDB4221	B1.G102-0971.2	G1020971	FDB725	B1.G102-0608.2	G1020608	FDS1073	B1.G102-0411.2	G1020411
FDB4222	B1.G102-0920.2	G1020920	FDB729	B1.G102-0215.2	G1020215	FDS1081	B1.G102-0334.2	G1020334
FDB4223	B1.G102-0895.2	G1020895	FDB729	B1.G102-0296.2	G1020296	FDS1082	B1.G102-0332.2	G1020332
FDB4224	B1.G102-0946.2	G1020946	FDB730	B1.G102-0296.2	G1020296	FDS1083	B1.G102-0492.2	G1020492
FDB4228	B1.G102-0817.2	G1020817	FDB732	B1.G102-0317.2	G1020317	FDS1083	B1.G102-0549.2	G1020549
FDB4233	B1.G102-0819.2	G1020819	FDB745	B1.G102-0275.2	G1020275	FDS1101	B1.G102-0408.2	G1020408
FDB4234	B1.G120-1047.2	G1201047	FDB749	B1.G102-0259.2	G1020259	FDS1112	B1.G102-0451.2	G1020451
FDB4235	B1.G120-1035.2	G1201035	FDB766	B1.G102-0265.2	G1020265	FDS1113	B1.G102-0236.2	G1020236

# Cross reference list

Liste des correspondances / Tabella di conversione codici / Lista de comparação /



Lista porównawcza numerów / Porovnávací seznam čísel

FERODO 	FERODO 	FERODO 
FDS1134	B1.G102-0392.2 G1020392	FDS850 B1.G102-0316.2 G1020316
FDS1160	B1.G102-0351.2 G1020351	FDS857 B1.G102-0367.2 G1020367
FDS1288	B1.G102-0390.2 G1020390	FDS876 B1.G102-0292.2 G1020292
FDS1289	B1.G102-0421.2 G1020421	FDS876 B1.G102-0293.2 G1020293
FDS1293	B1.G102-0542.2 G1020542	FDS925 B1.G102-0298.2 G1020298
FDS1294	B1.G102-0554.2 G1020554	FDS995 B1.G102-0359.2 G1020359
FDS1295	B1.G102-0550.2 G1020550	FDS998 B1.G102-0372.2 G1020372
FDS1300	B1.G102-0608.2 G1020608	FQT1000 B1.G102-0310.2 G1020310
FDS1301	B1.G102-0316.2 G1020316	FQT1002 B1.G102-0350.2 G1020350
FDS1303	B1.G120-1272.2 G1201272	FQT1040 B1.G102-0340.2 G1020340
FDS1308	B1.G102-0883.2 G1020883	FQT1050 B1.G102-0776.2 G1020776
FDS1312	B1.G102-0444.2 G1020444	FQT1052 B1.G102-0360.2 G1020360
FDS1318	B1.G102-0505.2 G1020505	FQT1056 B1.G102-0342.2 G1020342
FDS1323	B1.G102-0313.2 G1020313	FQT1063 B1.G102-0363.2 G1020363
FDS1349	B1.G102-0568.2 G1020568	FQT1068 B1.G102-0403.2 G1020403
FDS1370	B1.G102-0513.2 G1020513	FQT1073 B1.G102-0411.2 G1020411
FDS1376	B1.G102-0448.2 G1020448	FQT1075 B1.G102-0415.2 G1020415
FDS1398	B1.G102-0463.2 G1020463	FQT1082 B1.G102-0332.2 G1020333
FDS1419	B1.G102-0732.2 G1020732	FQT1083 B1.G102-0492.2 G1020492
FDS1444	B1.G120-5344.2 G1205344	FQT1083 B1.G102-0549.2 G1020549
FDS1463	B1.G102-0512.2 G1020512	FQT1094 B1.G102-0331.2 G1020331
FDS1467	B1.G102-0503.2 G1020503	FQT1101 B1.G102-0408.2 G1020408
FDS1468	B1.G102-0504.2 G1020504	FQT1112 B1.G102-0451.2 G1020451
FDS1469	B1.G102-0515.2 G1020515	FQT1113 B1.G102-0236.2 G1020236
FDS1499	B1.G102-0646.2 G1020646	FQT1117 B1.G102-0271.2 G1020271
FDS1500	B1.G102-0648.2 G1020648	FQT1134 B1.G102-0392.2 G1020392
FDS1568	B1.G102-0692.2 G1020692	FQT1135 B1.G102-0497.2 G1020497
FDS1573	B1.G102-0712.2 G1020712	FQT1168 B1.G102-0293.2 G1020293
FDS173	B1.G102-0015.2 G1020015	FQT1288 B1.G102-0390.2 G1020390
FDS1807	B1.G102-0850.2 G1020850	FQT1293 B1.G102-0542.2 G1020542
FDS370	B1.G102-0140.2 G1020140	FQT1294 B1.G102-0554.2 G1020554
FDS392	B1.G102-0010.2 G1020010	FQT1295 B1.G102-0550.2 G1020550
FDS393	B1.G102-0214.2 G1020214	FQT1299 B1.G102-0360.2 G1020360
FDS406	B1.G102-0326.2 G1020326	FQT1299 B1.G102-0473.2 G1020473
FDS434	B1.G102-0213.2 G1020213	FQT1300 B1.G102-0608.2 G1020608
FDS541	B1.G102-0201.2 G1020201	FQT1301 B1.G102-0316.2 G1020316
FDS541	B1.G102-0345.2 G1020345	FQT1303 B1.G120-1272.2 G1201272
FDS558	B1.G102-0216.2 G1020216	FQT1318 B1.G102-0505.2 G1020505
FDS558	B1.G102-0522.2 G1020522	FQT1319 B1.G102-0507.2 G1020507
FDS578	B1.G102-0308.2 G1020308	FQT1323 B1.G102-0313.2 G1020313
FDS584	B1.G102-0258.2 G1020258	FQT1349 B1.G102-0568.2 G1020568
FDS586	B1.G102-0272.2 G1020272	FQT1370 B1.G102-0513.2 G1020513
FDS617	B1.G102-0423.2 G1020423	FQT1376 B1.G102-0448.2 G1020448
FDS725	B1.G102-0608.2 G1020608	FQT1394 B1.G102-0519.2 G1020519
FDS729	B1.G102-0215.2 G1020215	FQT1398 B1.G102-0463.2 G1020463
FDS729	B1.G102-0296.2 G1020296	FQT1416 B1.G102-0563.2 G1020563
FDS732	B1.G102-0317.2 G1020317	FQT1420 B1.G102-0569.2 G1020569
FDS745	B1.G102-0275.2 G1020275	FQT1424 B1.G102-0545.2 G1020545
FDS749	B1.G102-0259.2 G1020259	FQT1425 B1.G102-0562.2 G1020562
FDS766	B1.G102-0265.2 G1020265	FQT1428 B1.G102-0924.2 G1020924
FDS767	B1.G102-0265.2 G1020265	FQT1429 B1.G102-0925.2 G1020925
FDS774	B1.G102-0273.2 G1020273	FQT1467 B1.G102-0503.2 G1020503
FDS775	B1.G102-0196.2 G1020196	FQT1467 B1.G120-1225.2 G1201225
FDS775	B1.G102-0274.2 G1020274	FQT1469 B1.G102-0515.2 G1020515
FDS776	B1.G102-0722.2 G1020722	FQT1473 B1.G102-0901.2 G1020901
FDS779	B1.G102-0474.2 G1020474	FQT1474 B1.G120-5366.2 G1205366
FDS845	B1.G102-0501.2 G1020501	FQT1476 B1.G102-0614.2 G1020614
		FQT1476 B1.G102-0735.2 G1020735
		FQT1481 B1.G102-0564.2 G1020564
		FQT1491 B1.G102-0489.2 G1020489
		FQT1496 B1.G102-0557.2 G1020557
		FQT1521 B1.G102-0610.2 G1020610
		FQT1526 B1.G102-0985.2 G1020985
		FQT1556 B1.G102-0514.2 G1020514
		FQT1594 B1.G102-0622.2 G1020622
		FQT1635 B1.G102-0463.2 G1020463
		FQT1640 B1.G102-0765.2 G1020765
		FQT1651 B1.G102-0484.2 G1020484
		FQT1717 B1.G102-0313.2 G1020313
		FQT1788 B1.G102-0492.2 G1020492
		FQT1931 B1.G102-0727.2 G1020727
		FQT393 B1.G102-0214.2 G1020214
		FQT393 B1.G102-0501.2 G1020501
		FQT406 B1.G102-0326.2 G1020326
		FQT558 B1.G102-0216.2 G1020216
		FQT558 B1.G102-0522.2 G1020522
		FQT619 B1.G102-0373.2 G1020373
		FQT719 B1.G102-0295.2 G1020295
		FQT725 B1.G102-0608.2 G1020608
		FQT729 B1.G102-0215.2 G1020215
		FQT729 B1.G102-0296.2 G1020296
		FQT732 B1.G102-0317.2 G1020317
		FQT774 B1.G102-0273.2 G1020273
		FQT775 B1.G102-0196.2 G1020196
		FQT775 B1.G102-0274.2 G1020274
		FQT845 B1.G102-0501.2 G1020501
		FQT850 B1.G102-0316.2 G1020316
		FQT874 B1.G102-0328.2 G1020328
		FQT876 B1.G102-0292.2 G1020292
		FQT876 B1.G102-0293.2 G1020293
		FQT884 B1.G102-0320.2 G1020320
		FQT925 B1.G102-0298.2 G1020298
		FQT995 B1.G102-0359.2 G1020359
		FSL1000 B1.G102-0310.2 G1020310
		FSL1002 B1.G102-0350.2 G1020350
		FSL1021 B1.G120-5404.2 G1205404
		FSL1038 B1.G102-0742.2 G1020742
		FSL1039 B1.G102-0396.2 G1020396
		FSL1040 B1.G102-0340.2 G1020340
		FSL1043 B1.G102-0891.2 G1020891
		FSL1044 B1.G102-0395.2 G1020395
		FSL1045 B1.G102-0397.2 G1020397
		FSL105 B1.G102-0097.2 G1020097
		FSL1052 B1.G102-0360.2 G1020360
		FSL1054 B1.G102-0355.2 G1020355
		FSL1055 B1.G102-0312.2 G1020312
		FSL1056 B1.G102-0342.2 G1020342
		FSL1062 B1.G102-0362.2 G1020362
		FSL1063 B1.G102-0363.2 G1020363
		FSL1067 B1.G102-0258.2 G1020258
		FSL1068 B1.G102-0403.2 G1020403
		FSL1072 B1.G102-0344.2 G1020344
		FSL1073 B1.G102-0411.2 G1020411
		FSL1075 B1.G102-0415.2 G1020415

# Cross reference list

Liste des correspondances / Tabella di conversione codici / Lista de comparação /



Lista porównawcza numerów / Porovnávací seznam čísel

FERODO 	FERODO 	FERODO 			
FSL1081	B1.G102-0334.2 G1020334	FSL1461	B1.G102-0595.2 G1020595	FSL1985	B1.G102-0714.2 G1020714
FSL1082	B1.G102-0332.2 G1020333	FSL1463	B1.G102-0512.2 G1020512	FSL206	B1.G102-0334.2 G1020334
FSL1083	B1.G102-0492.2 G1020492	FSL1467	B1.G120-1225.2 G1201225	FSL212	B1.G102-0334.2 G1020334
FSL1083	B1.G102-0549.2 G1020549	FSL1472	B1.G102-0560.2 G1020560	FSL222	B1.G102-0246.2 G1020246
FSL1093	B1.G102-0457.2 G1020457	FSL1473	B1.G102-0901.2 G1020901	FSL287	B1.G102-0147.2 G1020147
FSL1094	B1.G102-0331.2 G1020331	FSL1474	B1.G120-5366.2 G1205366	FSL346	B1.G102-0141.2 G1020141
FSL1095	B1.G102-0458.2 G1020458	FSL1476	B1.G102-0614.2 G1020614	FSL370	B1.G102-0140.2 G1020140
FSL1101	B1.G102-0408.2 G1020408	FSL1476	B1.G102-0735.2 G1020735	FSL385	B1.G102-0025.2 G1020025
FSL1112	B1.G102-0451.2 G1020451	FSL1477	B1.G102-0570.2 G1020570	FSL392	B1.G102-0010.2 G1020010
FSL1113	B1.G102-0236.2 G1020236	FSL1478	B1.G102-0516.2 G1020516	FSL398	B1.G102-0028.2 G1020028
FSL1117	B1.G102-0271.2 G1020271	FSL1479	B1.G102-0517.2 G1020517	FSL4003	B1.G102-0859.2 G1020859
FSL1124	B1.G102-0459.2 G1020459	FSL1480	B1.G102-0518.2 G1020518	FSL4044	B1.G102-0983.2 G1020983
FSL1131	B1.G102-0315.2 G1020315	FSL1484	B1.G102-0527.2 G1020527	FSL4045	B1.G102-0823.2 G1020823
FSL1132	B1.G102-0658.2 G1020658	FSL1513	B1.G102-0478.2 G1020478	FSL4046	B1.G102-0988.2 G1020988
FSL1134	B1.G102-0392.2 G1020392	FSL1518	B1.G102-0534.2 G1020534	FSL4048	B1.G102-0768.2 G1020768
FSL1135	B1.G102-0497.2 G1020497	FSL1519	B1.G102-0524.2 G1020524	FSL4051	B1.G102-0866.2 G1020866
FSL1160	B1.G102-0351.2 G1020351	FSL1520	B1.G102-0650.2 G1020650	FSL406	B1.G102-0326.2 G1020326
FSL1163	B1.G102-0419.2 G1020419	FSL1521	B1.G102-0610.2 G1020610	FSL4080	B1.G102-0856.2 G1020856
FSL1167	B1.G102-0312.2 G1020312	FSL1526	B1.G102-0985.2 G1020985	FSL4136	B1.G102-0994.2 G1020994
FSL1168	B1.G102-0293.2 G1020293	FSL1544	B1.G102-0685.2 G1020685	FSL4160	B1.G102-0893.2 G1020893
FSL1276	B1.G102-0423.2 G1020423	FSL1568	B1.G102-0692.2 G1020692	FSL4177	B1.G120-1029.2 G1201029
FSL1288	B1.G102-0390.2 G1020390	FSL1573	B1.G102-0712.2 G1020712	FSL4179	B1.G120-1053.2 G1201053
FSL1289	B1.G102-0421.2 G1020421	FSL1576	B1.G120-5238.2 G1205238	FSL419	B1.G102-0009.2 G1020009
FSL1293	B1.G102-0542.2 G1020542	FSL1599	B1.G102-0513.2 G1020513	FSL4260	B1.G102-0920.2 G1020920
FSL1294	B1.G102-0554.2 G1020554	FSL1635	B1.G102-0463.2 G1020463	FSL434	B1.G102-0213.2 G1020213
FSL1295	B1.G102-0550.2 G1020550	FSL1636	B1.G102-0682.2 G1020682	FSL434	B1.G102-0299.2 G1020299
FSL1300	B1.G102-0608.2 G1020608	FSL1639	B1.G120-5418.2 G1205418	FSL440	B1.G102-0219.2 G1020219
FSL1301	B1.G102-0316.2 G1020316	FSL1641	B1.G102-0680.2 G1020680	FSL455	B1.G102-0213.2 G1020213
FSL1303	B1.G102-0440.2 G1020440	FSL1654	B1.G102-0593.2 G1020593	FSL524	B1.G102-0184.2 G1020184
FSL1303	B1.G120-1272.2 G1201272	FSL1721	B1.G102-0721.2 G1020721	FSL525	B1.G102-0271.2 G1020271
FSL1305	B1.G102-0584.2 G1020584	FSL173	B1.G102-0015.2 G1020015	FSL535	B1.G102-0269.2 G1020269
FSL1312	B1.G102-0444.2 G1020444	FSL1736	B1.G120-1025.2 G1201025	FSL535	B1.G102-0275.2 G1020275
FSL1318	B1.G102-0505.2 G1020505	FSL1771	B1.G102-0937.2 G1020937	FSL541	B1.G102-0201.2 G1020201
FSL1319	B1.G102-0507.2 G1020507	FSL1772	B1.G102-0938.2 G1020938	FSL541	B1.G102-0345.2 G1020345
FSL1323	B1.G102-0313.2 G1020313	FSL1777	B1.G102-0770.2 G1020770	FSL558	B1.G102-0216.2 G1020216
FSL1370	B1.G102-0513.2 G1020513	FSL1781	B1.G102-0501.2 G1020501	FSL558	B1.G102-0522.2 G1020522
FSL1376	B1.G102-0448.2 G1020448	FSL1807	B1.G102-0850.2 G1020850	FSL578	B1.G102-0308.2 G1020308
FSL1381	B1.G102-0597.2 G1020597	FSL1833	B1.G102-0756.2 G1020756	FSL579	B1.G102-0026.2 G1020026
FSL1382	B1.G102-0578.2 G1020578	FSL1875	B1.G102-0774.2 G1020774	FSL584	B1.G102-0258.2 G1020258
FSL1384	B1.G102-0537.2 G1020537	FSL1876	B1.G102-0397.2 G1020397	FSL586	B1.G102-0272.2 G1020272
FSL1393	B1.G102-0467.2 G1020467	FSL1885	B1.G102-0625.2 G1020625	FSL589	B1.G102-0332.2 G1020333
FSL1394	B1.G102-0519.2 G1020519	FSL1891	B1.G120-1065.2 G1201065	FSL590	B1.G102-0311.2 G1020311
FSL1396	B1.G102-0482.2 G1020482	FSL1892	B1.G120-1022.2 G1201022	FSL615	B1.G102-0329.2 G1020329
FSL1397	B1.G102-0483.2 G1020483	FSL1897	B1.G102-0889.2 G1020889	FSL617	B1.G102-0423.2 G1020423
FSL1398	B1.G102-0463.2 G1020463	FSL1898	B1.G120-1009.2 G1201009	FSL619	B1.G102-0373.2 G1020373
FSL1411	B1.G102-0602.2 G1020602	FSL1907	B1.G102-0659.2 G1020659	FSL676	B1.G102-0955.2 G1020955
FSL1413	B1.G102-0604.2 G1020604	FSL1923	B1.G102-0763.2 G1020763	FSL700	B1.G102-0617.2 G1020617
FSL1415	B1.G102-0487.2 G1020487	FSL1924	B1.G102-0872.2 G1020872	FSL701	B1.G102-0618.2 G1020618
FSL1416	B1.G102-0563.2 G1020563	FSL1925	B1.G102-0764.2 G1020764	FSL719	B1.G102-0295.2 G1020295
FSL1420	B1.G102-0569.2 G1020569	FSL1927	B1.G102-0730.2 G1020730	FSL722	B1.G102-0315.2 G1020315
FSL1423	B1.G102-0605.2 G1020605	FSL1928	B1.G102-0801.2 G1020801	FSL725	B1.G102-0608.2 G1020608
FSL1424	B1.G102-0545.2 G1020545	FSL1929	B1.G102-0800.2 G1020800	FSL729	B1.G102-0215.2 G1020215
FSL1425	B1.G102-0562.2 G1020562	FSL1930	B1.G102-0802.2 G1020802	FSL729	B1.G102-0296.2 G1020296
FSL1444	B1.G120-5344.2 G1205344	FSL1933	B1.G120-1135.2 G1201135	FSL730	B1.G102-0296.2 G1020296
FSL1451	B1.G102-0511.2 G1020511	FSL1934	B1.G102-0979.2 G1020979	FSL732	B1.G102-0317.2 G1020317
FSL1452	B1.G102-0624.2 G1020624	FSL1935	B1.G102-0981.2 G1020981	FSL745	B1.G102-0275.2 G1020275
FSL1453	B1.G102-0627.2 G1020627	FSL1974	B1.G102-0794.2 G1020794	FSL749	B1.G102-0259.2 G1020259

# Cross reference list

Liste des correspondances / Tabella di conversione codici / Lista de comparação /

Lista porównawcza numerów / Porovnávací seznam čísel

FERODO 	FERODO 	FERODO 			
FSL766	B1.G102-0265.2 G1020265	FVR1497	B1.G102-0580.2 G1020580	TAR1072	B1.G102-0344.2 G1020344
FSL767	B1.G102-0265.2 G1020265	FVR1515	B1.G102-0633.2 G1020633	TAR1081	B1.G102-0334.2 G1020334
FSL774	B1.G102-0273.2 G1020273	FVR1516	B1.G102-0529.2 G1020529	TAR1082	B1.G102-0332.2 G1020333
FSL775	B1.G102-0196.2 G1020196	FVR1518	B1.G102-0534.2 G1020534	TAR1083	B1.G102-0492.2 G1020492
FSL775	B1.G102-0274.2 G1020274	FVR1519	B1.G102-0524.2 G1020524	TAR1083	B1.G102-0549.2 G1020549
FSL776	B1.G102-0722.2 G1020722	FVR1568	B1.G102-0692.2 G1020692	TAR1093	B1.G102-0457.2 G1020457
FSL779	B1.G102-0474.2 G1020474	FVR1642	B1.G102-0707.2 G1020707	TAR1094	B1.G102-0331.2 G1020331
FSL785	B1.G102-0304.2 G1020304	FVR1643	B1.G102-0706.2 G1020706	TAR1095	B1.G102-0458.2 G1020458
FSL799	B1.G102-0400.2 G1020400	FVR1644	B1.G102-0691.2 G1020691	TAR1101	B1.G102-0408.2 G1020408
FSL845	B1.G102-0501.2 G1020501	FVR1647	B1.G102-0699.2 G1020699	TAR1112	B1.G102-0451.2 G1020451
FSL850	B1.G102-0316.2 G1020316	FVR1771	B1.G102-0937.2 G1020937	TAR1113	B1.G102-0236.2 G1020236
FSL874	B1.G102-0328.2 G1020328	FVR1772	B1.G102-0938.2 G1020938	TAR1117	B1.G102-0271.2 G1020271
FSL876	B1.G102-0292.2 G1020292	FVR1777	B1.G102-0770.2 G1020770	TAR1124	B1.G102-0459.2 G1020459
FSL876	B1.G102-0293.2 G1020293	FVR1778	B1.G102-0769.2 G1020769	TAR1131	B1.G102-0315.2 G1020315
FSL877	B1.G102-0777.2 G1020777	FVR1779	B1.G102-0940.2 G1020940	TAR1132	B1.G102-0658.2 G1020658
FSL878	B1.G102-0327.2 G1020327	FVR1780	B1.G102-0766.2 G1020766	TAR1135	B1.G102-0497.2 G1020497
FSL881	B1.G102-0323.2 G1020323	FVR1780	B1.G102-0922.2 G1020922	TAR1160	B1.G102-0351.2 G1020351
FSL884	B1.G102-0320.2 G1020320	FVR1780	B1.G102-0940.2 G1020940	TAR1163	B1.G102-0419.2 G1020419
FSL901	B1.G102-0369.2 G1020369	FVR1876	B1.G102-0397.2 G1020397	TAR1167	B1.G102-0312.2 G1020312
FSL925	B1.G102-0298.2 G1020298	FVR1879	B1.G102-0891.2 G1020891	TAR1168	B1.G102-0293.2 G1020293
FSL954	B1.G102-0196.2 G1020196	FVR1923	B1.G102-0763.2 G1020763	TAR1276	B1.G102-0423.2 G1020423
FSL954	B1.G102-0197.2 G1020197	FVR1924	B1.G102-0872.2 G1020872	TAR1288	B1.G102-0390.2 G1020390
FSL967	B1.G102-0301.2 G1020301	FVR1925	B1.G102-0764.2 G1020764	TAR1289	B1.G102-0421.2 G1020421
FSL968	B1.G102-0302.2 G1020302	FVR1926	B1.G102-0873.2 G1020873	TAR1293	B1.G102-0542.2 G1020542
FSL969	B1.G102-0379.2 G1020379	FVR1927	B1.G102-0730.2 G1020730	TAR1294	B1.G102-0554.2 G1020554
FSL970	B1.G102-0347.2 G1020347	FVR1928	B1.G102-0801.2 G1020801	TAR1295	B1.G102-0550.2 G1020550
FSL973	B1.G102-0271.2 G1020271	FVR1929	B1.G102-0800.2 G1020800	TAR1300	B1.G102-0608.2 G1020608
FSL995	B1.G102-0359.2 G1020359	FVR1930	B1.G102-0802.2 G1020802	TAR1301	B1.G102-0316.2 G1020316
FVR1000	B1.G102-0310.2 G1020310	FVR287	B1.G102-0147.2 G1020147	TAR1303	B1.G102-0440.2 G1020440
FVR1002	B1.G102-0350.2 G1020350	FVR4036	B1.G102-0828.2 G1020828	TAR1312	B1.G102-0444.2 G1020444
FVR1038	B1.G102-0742.2 G1020742	FVR4037	B1.G102-0825.2 G1020825	TAR1318	B1.G102-0505.2 G1020505
FVR1039	B1.G102-0396.2 G1020396	FVR4347	B1.G102-0905.2 G1020905	TAR1319	B1.G102-0507.2 G1020507
FVR1043	B1.G102-0891.2 G1020891	FVR700	B1.G102-0617.2 G1020617	TAR1323	B1.G102-0313.2 G1020313
FVR1044	B1.G102-0395.2 G1020395	FVR701	B1.G102-0618.2 G1020618	TAR1370	B1.G102-0513.2 G1020513
FVR1045	B1.G102-0397.2 G1020397	FVR722	B1.G102-0315.2 G1020315	TAR1381	B1.G102-0597.2 G1020597
FVR1102	B1.G102-0357.2 G1020357	FVR785	B1.G102-0304.2 G1020304	TAR1384	B1.G102-0537.2 G1020537
FVR1131	B1.G102-0315.2 G1020315	FVR967	B1.G102-0301.2 G1020301	TAR1393	B1.G102-0467.2 G1020467
FVR1132	B1.G102-0658.2 G1020658	FVR968	B1.G102-0302.2 G1020302	TAR1394	B1.G102-0519.2 G1020519
FVR1163	B1.G102-0419.2 G1020419	FVR970	B1.G102-0347.2 G1020347	TAR1396	B1.G102-0482.2 G1020482
FVR1304	B1.G102-0582.2 G1020582	LP1987	B1.G102-0979.2 G1020979	TAR1397	B1.G102-0483.2 G1020483
FVR1305	B1.G102-0584.2 G1020584	TAR1000	B1.G102-0310.2 G1020310	TAR1398	B1.G102-0463.2 G1020463
FVR1306	B1.G102-0583.2 G1020583	TAR1002	B1.G102-0350.2 G1020350	TAR1415	B1.G102-0487.2 G1020487
FVR1338	B1.G102-0617.2 G1020617	TAR1021	B1.G120-5404.2 G1205404	TAR1416	B1.G102-0563.2 G1020563
FVR1339	B1.G102-0618.2 G1020618	TAR1038	B1.G102-0742.2 G1020742	TAR1420	B1.G102-0569.2 G1020569
FVR1381	B1.G102-0597.2 G1020597	TAR1039	B1.G102-0396.2 G1020396	TAR1423	B1.G102-0605.2 G1020605
FVR1396	B1.G102-0482.2 G1020482	TAR1040	B1.G102-0340.2 G1020340	TAR1424	B1.G102-0545.2 G1020545
FVR1397	B1.G102-0483.2 G1020483	TAR1044	B1.G102-0395.2 G1020395	TAR1425	B1.G102-0562.2 G1020562
FVR1452	B1.G102-0624.2 G1020624	TAR1045	B1.G102-0397.2 G1020397	TAR1451	B1.G102-0511.2 G1020511
FVR1453	B1.G102-0627.2 G1020627	TAR105	B1.G102-0097.2 G1020097	TAR1461	B1.G102-0595.2 G1020595
FVR1461	B1.G102-0595.2 G1020595	TAR1052	B1.G102-0360.2 G1020360	TAR1463	B1.G102-0512.2 G1020512
FVR1478	B1.G102-0516.2 G1020516	TAR1054	B1.G102-0355.2 G1020355	TAR1477	B1.G102-0570.2 G1020570
FVR1479	B1.G102-0517.2 G1020517	TAR1055	B1.G102-0312.2 G1020312	TAR1513	B1.G102-0478.2 G1020478
FVR1480	B1.G102-0518.2 G1020518	TAR1056	B1.G102-0342.2 G1020342	TAR1520	B1.G102-0650.2 G1020650
FVR1484	B1.G102-0527.2 G1020527	TAR1062	B1.G102-0362.2 G1020362	TAR206	B1.G102-0334.2 G1020334
FVR1492	B1.G102-0533.2 G1020533	TAR1063	B1.G102-0363.2 G1020363	TAR287	B1.G102-0147.2 G1020147
FVR1493	B1.G102-0751.2 G1020751	TAR1067	B1.G102-0258.2 G1020258	TAR328	B1.G102-0022.2 G1020022
FVR1494	B1.G102-0752.2 G1020752	TAR1068	B1.G102-0403.2 G1020403	TAR346	B1.G102-0141.2 G1020141







# Cross reference list

Liste des correspondances / Tabella di conversione codici / Lista de comparação /



Lista porównawcza numerów / Porovnávací seznam čísel

FERODO 	FERODO 	FIAT 
TAR370	B1.G102-0140.2 G1020140	TAR876 B1.G102-0292.2 G1020292
TAR375	B1.G102-0015.2 G1020015	TAR876 B1.G102-0293.2 G1020293
TAR385	B1.G102-0025.2 G1020025	TAR877 B1.G102-0777.2 G1020777
TAR392	B1.G102-0010.2 G1020010	TAR878 B1.G102-0327.2 G1020327
TAR393	B1.G102-0214.2 G1020214	TAR881 B1.G102-0323.2 G1020323
TAR398	B1.G102-0028.2 G1020028	TAR884 B1.G102-0320.2 G1020320
TAR406	B1.G102-0326.2 G1020326	TAR901 B1.G102-0369.2 G1020369
TAR415	B1.G102-0044.2 G1020044	TAR925 B1.G102-0298.2 G1020298
TAR419	B1.G102-0009.2 G1020009	TAR954 B1.G102-0196.2 G1020196
TAR419	B1.G102-0025.2 G1020025	TAR954 B1.G102-0197.2 G1020197
TAR434	B1.G102-0213.2 G1020213	TAR967 B1.G102-0301.2 G1020301
TAR434	B1.G102-0299.2 G1020299	TAR968 B1.G102-0302.2 G1020302
TAR440	B1.G102-0219.2 G1020219	TAR969 B1.G102-0379.2 G1020379
TAR455	B1.G102-0213.2 G1020213	TAR970 B1.G102-0347.2 G1020347
TAR524	B1.G102-0184.2 G1020184	TAR973 B1.G102-0271.2 G1020271
TAR525	B1.G102-0271.2 G1020271	TAR979 B1.G102-0046.2 G1020046
TAR535	B1.G102-0269.2 G1020269	TAR995 B1.G102-0359.2 G1020359
TAR535	B1.G102-0275.2 G1020275	
TAR541	B1.G102-0201.2 G1020201	<b>FIAT</b>
TAR541	B1.G102-0345.2 G1020345	791906 B1.G102-0141.2 G1020141
TAR558	B1.G102-0216.2 G1020216	792489 B1.G102-0140.2 G1020140
TAR578	B1.G102-0308.2 G1020308	792539 B1.G102-0141.2 G1020141
TAR579	B1.G102-0026.2 G1020026	792561 B1.G102-0141.2 G1020141
TAR584	B1.G102-0258.2 G1020258	792589 B1.G102-0141.2 G1020141
TAR586	B1.G102-0272.2 G1020272	792698 B1.G102-0140.2 G1020140
TAR589	B1.G102-0332.2 G1020332	792725 B1.G102-0141.2 G1020141
TAR590	B1.G102-0311.2 G1020311	793120 B1.G102-0184.2 G1020184
TAR615	B1.G102-0329.2 G1020329	793184 B1.G102-0140.2 G1020140
TAR617	B1.G102-0423.2 G1020423	793322 B1.G102-0141.2 G1020141
TAR619	B1.G102-0373.2 G1020373	793323 B1.G102-0141.2 G1020141
TAR669	B1.G102-0257.2 G1020257	793325 B1.G102-0141.2 G1020141
TAR676	B1.G102-0955.2 G1020955	793330 B1.G102-0140.2 G1020140
TAR700	B1.G102-0617.2 G1020617	793355 B1.G102-0140.2 G1020140
TAR701	B1.G102-0618.2 G1020618	793460 B1.G102-0140.2 G1020140
TAR719	B1.G102-0295.2 G1020295	793470 B1.G102-0140.2 G1020140
TAR722	B1.G102-0315.2 G1020315	794079 B1.G102-0184.2 G1020184
TAR725	B1.G102-0608.2 G1020608	794091 B1.G102-0140.2 G1020140
TAR729	B1.G102-0215.2 G1020215	794858 B1.G102-0140.2 G1020140
TAR729	B1.G102-0296.2 G1020296	794870 B1.G102-0184.2 G1020184
TAR730	B1.G102-0296.2 G1020296	795915 B1.G102-0350.2 G1020350
TAR732	B1.G102-0317.2 G1020317	5741585 B1.G120-1225.2 G1201225
TAR745	B1.G102-0275.2 G1020275	5743721 B1.G120-1225.2 G1201225
TAR749	B1.G102-0259.2 G1020259	5888147 B1.G102-0140.2 G1020140
TAR766	B1.G102-0265.2 G1020265	5888781 B1.G102-0184.2 G1020184
TAR767	B1.G102-0265.2 G1020265	5889089 B1.G102-0140.2 G1020140
TAR774	B1.G102-0273.2 G1020273	5892309 B1.G102-0141.2 G1020141
TAR775	B1.G102-0196.2 G1020196	5892310 B1.G102-0141.2 G1020141
TAR775	B1.G102-0274.2 G1020274	5892330 B1.G102-0184.2 G1020184
TAR776	B1.G102-0722.2 G1020722	5892481 B1.G102-0140.2 G1020140
TAR779	B1.G102-0474.2 G1020474	5892601 B1.G102-0140.2 G1020140
TAR785	B1.G102-0304.2 G1020304	5892727 B1.G102-0140.2 G1020140
TAR799	B1.G102-0400.2 G1020400	5892728 B1.G102-0140.2 G1020140
TAR845	B1.G102-0501.2 G1020501	5892730 B1.G102-0140.2 G1020140
TAR850	B1.G102-0316.2 G1020316	5892732 B1.G102-0140.2 G1020140
TAR853	B1.G102-0197.2 G1020197	5892733 B1.G102-0140.2 G1020140
TAR854	B1.G102-0337.2 G1020337	5892734 B1.G102-0140.2 G1020140
TAR874	B1.G102-0328.2 G1020328	5892735 B1.G102-0140.2 G1020140



# Cross reference list



Liste des correspondances / Tabella di conversione codici / Lista de comparação /  
Lista porównawcza numerów / Porovnávací seznam čísel

FIAT		FIAT		FORD				
77362743	B1.G102-0614.2	G1020614	77364897	B1.G102-0614.2	G1020614	1030601	B1.G102-0332.2	G1020333
77362768	B1.G102-0515.2	G1020515	77364919	B1.G102-0987.2	G1020987	1031781	B1.G102-0423.2	G1020423
77363341	B1.G102-0568.2	G1020568	77364961	B1.G102-0567.2	G1020567	1031843	B1.G102-0312.2	G1020312
77363420	B1.G102-0738.2	G1020738	77365026	B1.G120-1225.2	G1201225	1042688	B1.G102-0334.2	G1020334
77363445	B1.G102-0567.2	G1020567	77365113	B1.G120-1225.2	G1201225	1045994	B1.G225-0114.1	G2125114
77363496	B1.G102-0496.2	G1020496	77365337	B1.G102-0621.2	G1020621	1045995	B1.G210-0223.1	G2110223
77363518	B1.G102-0515.2	G1020515	77365379	B1.G102-0738.2	G1020738	1048308	B1.G102-0423.2	G1020423
77363579	B1.G102-0572.2	G1020572	77365465	B1.G120-1224.2	G1201224	1048309	B1.G102-0423.2	G1020423
77363580	B1.G102-0572.2	G1020572	77365468	B1.G120-1225.2	G1201225	1064762	B1.G102-0332.2	G1020333
77363599	B1.G102-0701.2	G1020701	77365543	B1.G120-1224.2	G1201224	1064763	B1.G102-0334.2	G1020334
77363604	B1.G102-0650.2	G1020650	77365623	B1.G102-0738.2	G1020738	1066271	B1.G220-0147.1	G2120147
77363607	B1.G102-0672.2	G1020672	77365651	B1.G120-1224.2	G1201224	1073731	B1.G102-0320.2	G1020320
77363610	B1.G102-0672.2	G1020672	77365716	B1.G102-0738.2	G1020738	1073732	B1.G102-0265.2	G1020265
77363818	B1.G102-0572.2	G1020572	77365754	B1.G102-0567.2	G1020567	1075558	B1.G102-0505.2	G1020505
77363819	B1.G102-0572.2	G1020572	77365809	B1.G120-1128.2	G1201128	1075565	B1.G102-0507.2	G1020507
77363942	B1.G102-0737.2	G1020737	77366017	B1.G102-0763.2	G1020763	1079347	B1.G102-0320.2	G1020320
77363956	B1.G102-0514.2	G1020514	77366021	B1.G102-0764.2	G1020764	1079348	B1.G102-0265.2	G1020265
77363958	B1.G102-0738.2	G1020738	77366023	B1.G102-0873.2	G1020873	1079919	B1.G102-0332.2	G1020333
77363974	B1.G102-0737.2	G1020737	77366134	B1.G120-1224.2	G1201224	1079920	B1.G102-0334.2	G1020334
77364014	B1.G102-0763.2	G1020763	82394418	B1.G210-0190.1	G2110190	1088934	B1.G102-0885.2	G1020885
77364015	B1.G102-0764.2	G1020764	82427592	B1.G222-0145.1	G2122145	1088938	B1.G102-0886.2	G1020886
77364016	B1.G102-0730.2	G1020730	82433859	B1.G210-0190.1	G2110190	1095201	B1.G102-0320.2	G1020320
77364024	B1.G102-0567.2	G1020567	82434070	B1.G210-0190.1	G2110190	1095202	B1.G102-0265.2	G1020265
77364158	B1.G102-0740.2	G1020740	82439939	B1.G210-0209.1	G2110209	1096940	B1.G102-0265.2	G1020265
77364160	B1.G102-0872.2	G1020872	82440275	B1.G210-0209.1	G2110209	1096942	B1.G102-0320.2	G1020320
77364161	B1.G102-0873.2	G1020873	82450539	B1.G222-0145.1	G2122145	1101462	B1.G102-0519.2	G1020519
77364168	B1.G102-0672.2	G1020672	82450657	B1.G222-0147.1	G2122147	1101464	B1.G102-0519.2	G1020519
77364169	B1.G102-0672.2	G1020672	92498609	B1.G212-0127.1	G2112127	1107697	B1.G102-0505.2	G1020505
77364224	B1.G102-0650.2	G1020650	1300501080	B1.G224-0127.1	G2124127	1107698	B1.G102-0507.2	G1020507
77364273	B1.G102-0572.2	G1020572	1307356080	B1.G224-0138.1	G2124138	1111857	B1.G102-0467.2	G1020467
77364281	B1.G102-0614.2	G1020614	1316323080	B1.G220-0155.1	G2120155	1111858	B1.G102-0467.2	G1020467
77364318	B1.G102-0764.2	G1020764	9404251248	B1.G102-0291.2	G1020291	1112542	B1.G212-0141.1	G2112141
77364319	B1.G102-0873.2	G1020873	9404251518	B1.G102-0350.2	G1020350	1115107	B1.G102-0549.2	G1020549
77364331	B1.G102-0896.2	G1020896	9404252328	B1.G102-0549.2	G1020549	1121894	B1.G102-0562.2	G1020562
77364332	B1.G102-0896.2	G1020896	9467548887	B1.G102-0937.2	G1020937	1121895	B1.G102-0563.2	G1020563
77364393	B1.G102-0737.2	G1020737	9467548987	B1.G102-0937.2	G1020937	1126718	B1.G102-0562.2	G1020562
77364394	B1.G102-0737.2	G1020737	9467549087	B1.G102-0938.2	G1020938	1128463	B1.G102-0519.2	G1020519
77364447	B1.G102-0514.2	G1020514	16420.26100.01/00	B1.G210-0190.1	G2110190	1129985	B1.G102-0885.2	G1020885
77364473	B1.G102-0738.2	G1020738	K68020494AB	B1.G120-5241.2	G1205241	1129986	B1.G102-0886.2	G1020886
77364477	B1.G102-0737.2	G1020737	K68028671AA	B1.G120-5230.2	G1205230	1130120	B1.G102-0563.2	G1020563
77364511	B1.G102-0937.2	G1020937				1130715	B1.G102-0467.2	G1020467
77364512	B1.G102-0937.2	G1020937	<b>FORD</b>			1130751	B1.G102-0423.2	G1020423
77364513	B1.G102-0938.2	G1020938	1001093	B1.G225-0114.1	G2125114	1130758	B1.G102-0265.2	G1020265
77364517	B1.G102-0987.2	G1020987	1001094	B1.G210-0223.1	G2110223	1133445	B1.G102-0557.2	G1020557
77364567	B1.G102-0568.2	G1020568	1001095	B1.G102-0312.2	G1020312	1133446	B1.G102-0580.2	G1020580
77364587	B1.G102-0701.2	G1020701	1001096	B1.G102-0549.2	G1020549	1133447	B1.G102-0564.2	G1020564
77364588	B1.G102-0740.2	G1020740	1010502	B1.G102-0332.2	G1020333	1133448	B1.G102-0654.2	G1020654
77364589	B1.G102-0504.2	G1020504	1010503	B1.G102-0334.2	G1020334	1133750	B1.G102-0423.2	G1020423
77364599	B1.G102-0503.2	G1020503	1013581	B1.G212-0141.1	G2112141	1134158	B1.G102-0617.2	G1020617
77364635	B1.G102-0951.2	G1020951	1013843	B1.G102-0332.2	G1020333	1134159	B1.G102-0618.2	G1020618
77364636	B1.G102-0952.2	G1020952	1019598	B1.G212-0141.1	G2112141	1135167	B1.G102-0597.2	G1020597
77364637	B1.G102-0737.2	G1020737	1019604	B1.G220-0147.1	G2120147	1136519	B1.G102-0505.2	G1020505
77364798	B1.G102-0740.2	G1020740	1022079	B1.G102-0265.2	G1020265	1144288	B1.G102-0595.2	G1020595
77364839	B1.G102-0568.2	G1020568	1023605	B1.G210-0223.1	G2110223	1145299	B1.G102-0519.2	G1020519
77364859	B1.G102-0517.2	G1020517	1025911	B1.G220-0146.1	G2120146	1148202	B1.G222-0172.1	G2122172
77364874	B1.G120-1224.2	G1201224	1027640	B1.G102-0549.2	G1020549	1151049	B1.G102-0505.2	G1020505
77364875	B1.G102-0738.2	G1020738	1027703	B1.G102-0312.2	G1020312	1151377	B1.G102-0593.2	G1020593

# Cross reference list

Liste des correspondances / Tabella di conversione codici / Lista de comparação /

Lista porównawcza numerów / Porovnávací seznam čísel



FORD		FORD		FORD	
1152316	B1.G102-0563.2 G1020563	1371403	B1.G102-0800.2 G1020800	1521329	B1.G102-0625.2 G1020625
1204843	B1.G102-0562.2 G1020562	1371454	B1.G102-0802.2 G1020802	1522073	B1.G102-0625.2 G1020625
1204845	B1.G102-0563.2 G1020563	1373360	B1.G211-0155.1 G2111155	1523795	B1.G223-0113.1 G2123113
1204850	B1.G102-0885.2 G1020885	1373361	B1.G211-0158.1 G2111158	1530602	B1.G102-0802.2 G1020802
1204852	B1.G102-0886.2 G1020886	1373369	B1.G225-0117.1 G2125117	1535924	B1.G223-0113.1 G2123113
1205696	B1.G102-0580.2 G1020580	1373370	B1.G225-0162.1 G2125162	1541806	B1.G220-0184.1 G2120184
1206062	B1.G102-0467.2 G1020467	1373781	B1.G210-0115.1 G2110115	1546835	B1.G223-0113.1 G2123113
1207104	B1.G102-0563.2 G1020563	1376118	B1.G224-0161.1 G2124161	1550219	B1.G120-1053.2 G1201053
1207519	B1.G102-0564.2 G1020564	1376138	B1.G212-0154.1 G2112154	1553797	B1.G102-0801.2 G1020801
1219892	B1.G102-0563.2 G1020563	1379931	B1.G211-0145.1 G2111145	1554523	B1.G102-0800.2 G1020800
1219894	B1.G102-0563.2 G1020563	1379965	B1.G228-0154.1 G2128154	1554524	B1.G102-0802.2 G1020802
1223540	B1.G211-0155.1 G2111155	1379971	B1.G102-0889.2 G1020889	1559697	B1.G102-0952.2 G1020952
1223543	B1.G211-0155.1 G2111155	1384689	B1.G228-0154.1 G2128154	1559698	B1.G102-0951.2 G1020951
1223566	B1.G211-0158.1 G2111158	1385590	B1.G211-0145.1 G2111145	1560014	B1.G102-0801.2 G1020801
1223568	B1.G211-0158.1 G2111158	1386603	B1.G102-0654.2 G1020654	1560023	B1.G102-0800.2 G1020800
1223663	B1.G225-0117.1 G2125117	1405500	B1.G211-0145.1 G2111145	1560026	B1.G102-0802.2 G1020802
1223664	B1.G225-0162.1 G2125162	1405510	B1.G228-0154.1 G2128154	1566096	B1.G102-0727.2 G1020727
1223665	B1.G225-0117.1 G2125117	1405511	B1.G120-1009.2 G1201009	1566234	B1.G102-0786.2 G1020786
1223666	B1.G225-0162.1 G2125162	1420600	B1.G228-0154.1 G2128154	1575733	B1.G211-0155.1 G2111155
1223682	B1.G102-0622.2 G1020622	1420601	B1.G228-0154.1 G2128154	1575734	B1.G225-0117.1 G2125117
1227108	B1.G102-0563.2 G1020563	1423389	B1.G120-1009.2 G1201009	1595523	B1.G102-0334.2 G1020334
1233679	B1.G102-0727.2 G1020727	1425406	B1.G102-0505.2 G1020505	1619209	B1.G102-0334.2 G1020334
1236880	B1.G102-0519.2 G1020519	1425407	B1.G102-0507.2 G1020507	1630149	B1.G210-0115.1 G2110115
1250688	B1.G102-0562.2 G1020562	1426144	B1.G102-0787.2 G1020787	1637969	B1.G210-0115.1 G2110115
1253728	B1.G211-0155.1 G2111155	1427386	B1.G102-0889.2 G1020889	1638880	B1.G102-0028.2 G1020028
1253729	B1.G225-0117.1 G2125117	1431178	B1.G120-1009.2 G1201009	1647730	B1.G102-0026.2 G1020026
1253730	B1.G225-0117.1 G2125117	1432363	B1.G102-0889.2 G1020889	1648236	B1.G102-0028.2 G1020028
1253962	B1.G211-0158.1 G2111158	1433952	B1.G102-0801.2 G1020801	1652206	B1.G102-0028.2 G1020028
1253964	B1.G225-0162.1 G2125162	1433954	B1.G102-0800.2 G1020800	1659938	B1.G102-0332.2 G1020333
1253965	B1.G225-0162.1 G2125162	1433958	B1.G102-0802.2 G1020802	1669578	B1.G102-0951.2 G1020951
1318139	B1.G102-0597.2 G1020597	1436498	B1.G102-0889.2 G1020889	1675620	B1.G102-0951.2 G1020951
1318147	B1.G102-0595.2 G1020595	1437761	B1.G102-0889.2 G1020889	1679853	B1.G223-0113.1 G2123113
1320347	B1.G211-0155.1 G2111155	1439866	B1.G102-0787.2 G1020787	1682005	B1.G102-0786.2 G1020786
1320352	B1.G225-0117.1 G2125117	1439867	B1.G102-0786.2 G1020786	1683374	B1.G102-0727.2 G1020727
1320581	B1.G220-0147.1 G2120147	1458247	B1.G102-0889.2 G1020889	1686723	B1.G225-0199.1 G2125199
1320582	B1.G220-0147.1 G2120147	1459408	B1.G102-0786.2 G1020786	1695810	B1.G102-0622.2 G1020622
1320585	B1.G222-0172.1 G2122172	1459450	B1.G102-0787.2 G1020787	1712024	B1.G102-0622.2 G1020622
1321488	B1.G224-0161.1 G2124161	1465126	B1.G102-0332.2 G1020333	1721086	B1.G102-0800.2 G1020800
1321517	B1.G102-0622.2 G1020622	1465168	B1.G102-0595.2 G1020595	1731172	B1.G102-0951.2 G1020951
1323102	B1.G212-0154.1 G2112154	1468946	B1.G211-0155.1 G2111155	1734696	B1.G225-0117.1 G2125117
1323551	B1.G211-0158.1 G2111158	1469082	B1.G225-0117.1 G2125117	1747043	B1.G102-0889.2 G1020889
1323560	B1.G225-0162.1 G2125162	1469083	B1.G225-0162.1 G2125162	1748745	B1.G211-0155.1 G2111155
1323620	B1.G222-0172.1 G2122172	1469085	B1.G228-0154.1 G2128154	1752093	B1.G102-0787.2 G1020787
1323621	B1.G210-0115.1 G2110115	1473006	B1.G210-0115.1 G2110115	1753860	B1.G102-0727.2 G1020727
1324300	B1.G102-0727.2 G1020727	1477803	B1.G102-0786.2 G1020786	1756395	B1.G102-0786.2 G1020786
1343514	B1.G102-0549.2 G1020549	1500152	B1.G225-0162.1 G2125162	1790221	B1.G225-0199.1 G2125199
1345337	B1.G102-0564.2 G1020564	1500156	B1.G211-0158.1 G2111158	3555344	B1.G222-0172.1 G2122172
1345340	B1.G102-0549.2 G1020549	1500158	B1.G228-0154.1 G2128154	3573537	B1.G222-0172.1 G2122172
1355950	B1.G102-0692.2 G1020692	1500668	B1.G102-0886.2 G1020886	4056029	B1.G224-0120.1 G2124120
1356392	B1.G102-0625.2 G1020625	1501068	B1.G211-0155.1 G2111155	4070865	B1.G224-0120.1 G2124120
1360254	B1.G102-0727.2 G1020727	1501069	B1.G225-0117.1 G2125117	4071714	B1.G220-0147.1 G2120147
1360303	B1.G102-0692.2 G1020692	1503969	B1.G102-0787.2 G1020787	4077455	B1.G222-0172.1 G2122172
1360304	B1.G102-0670.2 G1020670	1508074	B1.G102-0622.2 G1020622	4077636	B1.G102-0597.2 G1020597
1360305	B1.G102-0622.2 G1020622	1514237	B1.G210-0115.1 G2110115	4083484	B1.G210-0115.1 G2110115
1360306	B1.G102-0727.2 G1020727	1517696	B1.G228-0154.1 G2128154	4084226	B1.G220-0147.1 G2120147
1368558	B1.G102-0772.2 G1020772	1519528	B1.G102-0622.2 G1020622	4095132	B1.G102-0595.2 G1020595
1371402	B1.G102-0801.2 G1020801	1520297	B1.G225-0162.1 G2125162	4097477	B1.G224-0161.1 G2124161



# Cross reference list

Liste des correspondances / Tabella di conversione codici / Lista de comparação /



Lista porównawcza numerów / Porovnávací seznam čísel

FORD 		FORD 		FORD 	
4097478	B1.G224-0161.1 G2124161	6162190	B1.G102-0332.2 G1020333	6G91-2C375-F1B	B1.G228-0154.1 G2128154
4098427	B1.G212-0154.1 G2112154	6162338	B1.G102-0028.2 G1020028	6G91-2K021-A2D	B1.G102-0889.2 G1020889
4098428	B1.G212-0154.1 G2112154	6166952	B1.G102-0334.2 G1020334	6G91-2M008-FC	B1.G102-0787.2 G1020787
4114749	B1.G102-0595.2 G1020595	6174117	B1.G102-0334.2 G1020334	6G91-2M008-FD	B1.G102-0787.2 G1020787
4115996	B1.G220-0146.1 G2120146	6178479	B1.G102-0334.2 G1020334	6G91-2M008-GC	B1.G102-0786.2 G1020786
4176921	B1.G212-0154.1 G2112154	6178480	B1.G102-0334.2 G1020334	6G91-2M008-GD	B1.G102-0786.2 G1020786
4179398	B1.G224-0161.1 G2124161	6180371	B1.G102-0423.2 G1020423	6G91-2M008-GF	B1.G102-0786.2 G1020786
4179406	B1.G212-0154.1 G2112154	6188427	B1.G102-0332.2 G1020333	6L8Z-2001-A	B1.G120-5352.2 G1205352
4181042	B1.G224-0161.1 G2124161	6189145	B1.G102-0334.2 G1020334	7G91-1125-BA	B1.G228-0154.1 G2128154
4346371	B1.G102-0692.2 G1020692	6189146	B1.G102-0334.2 G1020334	7M51-1125-FA	B1.G225-0117.1 G2125117
4367107	B1.G211-0154.1 G2111154	6189147	B1.G102-0026.2 G1020026	7M51-2A315-BA	B1.G211-0158.1 G2111158
4367108	B1.G211-0154.1 G2111154	6189148	B1.G102-0026.2 G1020026	7M51-2A315-FA	B1.G211-0155.1 G2111155
4387361	B1.G102-0692.2 G1020692	6191062	B1.G210-0196.1 G2110196	89BB-2K021-AB	B1.G102-0334.2 G1020334
4387371	B1.G102-0470.2 G1020470	6191063	B1.G210-0196.1 G2110196	89GB-2K021-AB	B1.G102-0026.2 G1020026
4427737	B1.G102-0692.2 G1020692	6191064	B1.G220-0147.1 G2120147	8V51-1125-AC	B1.G223-0113.1 G2123113
4457989	B1.G211-0154.1 G2111154	6197738	B1.G102-0617.2 G1020617	8V51-1125-AD	B1.G223-0113.1 G2123113
4475316	B1.G211-0154.1 G2111154	6197739	B1.G102-0618.2 G1020618	8V51-2K021-AA	B1.G120-1053.2 G1201053
4641690	B1.G120-5352.2 G1205352	6203650	B1.G102-0332.2 G1020333	91AB-2M008-BD	B1.G102-0290.2 G1020290
4778223	B1.G120-5352.2 G1205352	6500952	B1.G102-0423.2 G1020423	93BB-2K021-EB	B1.G102-0320.2 G1020320
4780654	B1.G120-5352.2 G1205352	6500954	B1.G102-0423.2 G1020423	93BB-2K021-FB	B1.G102-0265.2 G1020265
5015919	B1.G102-0334.2 G1020334	6500959	B1.G102-0290.2 G1020290	93GB-2K021-CA	B1.G102-0320.2 G1020320
5018899	B1.G102-0334.2 G1020334	6511773	B1.G102-0334.2 G1020334	93GB-2K021-CB	B1.G102-0320.2 G1020320
5020817	B1.G102-0026.2 G1020026	6669779	B1.G102-0885.2 G1020885	97BG-2K021-AA	B1.G102-0265.2 G1020265
5022652	B1.G210-0196.1 G2110196	6669780	B1.G102-0886.2 G1020886	97BG-2K021-AB	B1.G102-0265.2 G1020265
5022653	B1.G210-0196.1 G2110196	6704268	B1.G102-0334.2 G1020334	97BG-2K021-BA	B1.G102-0320.2 G1020320
5022654	B1.G220-0147.1 G2120147	6704269	B1.G102-0026.2 G1020026	97BG-2K021-BB	B1.G102-0320.2 G1020320
5022666	B1.G210-0115.1 G2110115	6704271	B1.G102-0423.2 G1020423	98AB-2K021-AD	B1.G102-0505.2 G1020505
5023483	B1.G210-0115.1 G2110115	6827588	B1.G102-0320.2 G1020320	9C11-2K021-BA	B1.G102-0800.2 G1020800
5023994	B1.G102-0334.2 G1020334	6877836	B1.G102-0320.2 G1020320	9M51-2A315-BA	B1.G211-0155.1 G2111155
5023998	B1.G102-0026.2 G1020026	6877837	B1.G102-0265.2 G1020265	9M51-2A315-BB	B1.G211-0155.1 G2111155
5025048	B1.G102-0332.2 G1020333	6882584	B1.G102-0320.2 G1020320	9S51-1125-DA	B1.G220-0184.1 G2120184
5025610	B1.G224-0131.1 G2124131	7018202	B1.G102-0617.2 G1020617	9S51-2K021-AA	B1.G102-0952.2 G1020952
5025929	B1.G102-0332.2 G1020333	7018203	B1.G102-0618.2 G1020618	9S51-2K021-BA	B1.G102-0951.2 G1020951
5025951	B1.G210-0213.1 G2110213	7114005	B1.G102-0290.2 G1020290	9S51-2K021-BB	B1.G102-0951.2 G1020951
5026661	B1.G102-0423.2 G1020423	7153476	B1.G102-0885.2 G1020885	9S51-2K021-BC	B1.G102-0951.2 G1020951
5026784	B1.G224-0120.1 G2124120	7153477	B1.G102-0886.2 G1020886	AV61-1125-BA	B1.G225-0117.1 G2125117
5026786	B1.G220-0146.1 G2120146	7204066	B1.G210-0115.1 G2110115	AV61-1125-BB	B1.G225-0117.1 G2125117
5027604	B1.G102-0423.2 G1020423	1M21-2K021-AA	B1.G102-0593.2 G1020593	AV61-1125-DA	B1.G225-0199.1 G2125199
5028281	B1.G220-0147.1 G2120147	1S7W-2A315-CB	B1.G212-0154.1 G2112154	AV61-1125-DB	B1.G225-0199.1 G2125199
5028763	B1.G102-0617.2 G1020617	2M5V-2K021-AA	B1.G102-0692.2 G1020692	AV61-2K021-BA	B1.G102-0622.2 G1020622
5028764	B1.G102-0618.2 G1020618	2T14-2A315-AB	B1.G211-0154.1 G2111154	AV61-2K021-BB	B1.G102-0622.2 G1020622
5029147	B1.G102-0320.2 G1020320	2T14-2A315-BB	B1.G211-0154.1 G2111154	AV61-2M008-AA	B1.G102-0727.2 G1020727
5029148	B1.G102-0265.2 G1020265	2T14-2K021-AC	B1.G102-0692.2 G1020692	BG91-2K021-AA	B1.G102-0889.2 G1020889
5029815	B1.G224-0131.1 G2124131	2T14-2M008-AA	B1.G102-0470.2 G1020470	BS51-2K021-BA	B1.G102-0951.2 G1020951
5030658	B1.G210-0115.1 G2110115	3M51-2A315-A1E	B1.G211-0155.1 G2111155	ME3M5J-2M008-AA	B1.G102-0727.2 G1020727
6095773	B1.G102-0334.2 G1020334	3M51-2A315-AE	B1.G211-0155.1 G2111155	ME6G9J-2M008-GA	B1.G102-0786.2 G1020786
6121697	B1.G102-0334.2 G1020334	3M51-2A315-ED	B1.G211-0158.1 G2111158	YM21-2K021-AA	B1.G102-0557.2 G1020557
6127520	B1.G102-0334.2 G1020334	3M51-2K021-AA	B1.G102-0622.2 G1020622	YM21-2K021-BA	B1.G102-0580.2 G1020580
6127527	B1.G102-0026.2 G1020026	3M51-2K021-AB	B1.G102-0622.2 G1020622	YM21-2M008-BA	B1.G102-0654.2 G1020654
6130483	B1.G102-0334.2 G1020334	3M51-2M008-AA	B1.G102-0727.2 G1020727	YM2J-2K021-BA	B1.G102-0580.2 G1020580
6132807	B1.G102-0334.2 G1020334	3M51-2M008-AB	B1.G102-0727.2 G1020727	YS61-2K021-AA	B1.G102-0467.2 G1020467
6136892	B1.G102-0026.2 G1020026	3M51-2M008-AC	B1.G102-0727.2 G1020727	YS61-2K021-DA	B1.G102-0519.2 G1020519
6136893	B1.G102-0334.2 G1020334	3M5J-2M008-A1A	B1.G102-0727.2 G1020727		
6141150	B1.G102-0028.2 G1020028	5M21-2M008-BB	B1.G102-0654.2 G1020654	<b>FTE</b>	
6144685	B1.G102-0334.2 G1020334	6C11-2K021-AE	B1.G102-0801.2 G1020801	BL1024A3	B1.G102-0304.2 G1020304
6147496	B1.G102-0334.2 G1020334	6C11-2K021-BE	B1.G102-0800.2 G1020800	BL1024B3	B1.G102-0304.2 G1020304
6158945	B1.G102-0334.2 G1020334	6C11-2M008-AE	B1.G102-0802.2 G1020802	BL1031A1	B1.G102-0329.2 G1020329

# Cross reference list



Liste des correspondances / Tabella di conversione codici / Lista de comparação /

Lista porównawcza numerów / Porovnávací seznam čísel

FTE		FTE		FTE	
BL1034A3	B1.G102-0273.2 G1020273	BL1202B2	B1.G102-0296.2 G1020296	BL1320B4	B1.G102-0337.2 G1020337
BL1035A3	B1.G102-0196.2 G1020196	BL1203A2	B1.G102-0213.2 G1020213	BL1323A2	B1.G102-0501.2 G1020501
BL1035A3	B1.G102-0274.2 G1020274	BL1203A2	B1.G102-0299.2 G1020299	BL1323B2	B1.G102-0501.2 G1020501
BL1035B3	B1.G102-0196.2 G1020196	BL1204A2	B1.G102-0308.2 G1020308	BL1324A1	B1.G102-0618.2 G1020618
BL1035B3	B1.G102-0274.2 G1020274	BL1204B2	B1.G102-0308.2 G1020308	BL1325A1	B1.G102-0617.2 G1020617
BL1037A2	B1.G102-0316.2 G1020316	BL1212A4	B1.G102-0044.2 G1020044	BL1326A2	B1.G102-0372.2 G1020372
BL1041A1	B1.G102-0097.2 G1020097	BL1212B4	B1.G102-0044.2 G1020044	BL1327A3	B1.G102-0347.2 G1020347
BL1060A1	B1.G102-0065.2 G1020065	BL1217A1	B1.G102-0271.2 G1020271	BL1327A4	B1.G102-0524.2 G1020524
BL1061A1	B1.G102-0065.2 G1020065	BL1219A4	B1.G102-0257.2 G1020257	BL1327B3	B1.G102-0347.2 G1020347
BL1073A1	B1.G102-0327.2 G1020327	BL1219B4	B1.G102-0257.2 G1020257	BL1329A2	B1.G102-0367.2 G1020367
BL1090A2	B1.G102-0065.2 G1020065	BL1220A2	B1.G102-0474.2 G1020474	BL1348A2	B1.G102-0265.2 G1020265
BL1112A1	B1.G102-0216.2 G1020216	BL1220B2	B1.G102-0474.2 G1020474	BL1350A3	B1.G102-0885.2 G1020885
BL1112A1	B1.G102-0522.2 G1020522	BL1224A2	B1.G102-0213.2 G1020213	BL1350A4	B1.G102-0886.2 G1020886
BL1114A1	B1.G102-0334.2 G1020334	BL1224B2	B1.G102-0213.2 G1020213	BL1352A3	B1.G102-0777.2 G1020777
BL1114B1	B1.G102-0334.2 G1020334	BL1229A2	B1.G102-0219.2 G1020219	BL1354A2	B1.G102-0299.2 G1020299
BL1118A1	B1.G102-0315.2 G1020315	BL1229B2	B1.G102-0219.2 G1020219	BL1355A2	B1.G102-0312.2 G1020312
BL1118A2	B1.G102-0533.2 G1020533	BL1229B2	B1.G102-0323.2 G1020323	BL1358A2	B1.G102-0328.2 G1020328
BL1122A3	B1.G102-0273.2 G1020273	BL1229F1	B1.G102-0323.2 G1020323	BL1360A2	B1.G102-0360.2 G1020360
BL1123A3	B1.G102-0196.2 G1020196	BL1230A1	B1.G102-0236.2 G1020236	BL1361A4	B1.G102-0265.2 G1020265
BL1123A3	B1.G102-0274.2 G1020274	BL1231A2	B1.G102-0184.2 G1020184	BL1368A2	B1.G102-0398.2 G1020398
BL1123B3	B1.G102-0196.2 G1020196	BL1231B2	B1.G102-0184.2 G1020184	BL1369A2	B1.G102-0401.2 G1020401
BL1123B3	B1.G102-0274.2 G1020274	BL1243A1	B1.G102-0272.2 G1020272	BL1369B2	B1.G102-0401.2 G1020401
BL1126A2	B1.G102-0311.2 G1020311	BL1243B1	B1.G102-0272.2 G1020272	BL1373A2	B1.G102-0722.2 G1020722
BL1138A4	B1.G102-0147.2 G1020147	BL1246A3	B1.G102-0246.2 G1020246	BL1381A4	B1.G102-0362.2 G1020362
BL1140A1	B1.G102-0022.2 G1020022	BL1246B3	B1.G102-0246.2 G1020246	BL1389A2	B1.G102-0301.2 G1020301
BL1140B1	B1.G102-0022.2 G1020022	BL1255A1	B1.G102-0423.2 G1020423	BL1390A2	B1.G102-0302.2 G1020302
BL1141A1	B1.G102-0046.2 G1020046	BL1255A2	B1.G102-0423.2 G1020423	BL1391A2	B1.G102-0310.2 G1020310
BL1151A4	B1.G102-0140.2 G1020140	BL1255B1	B1.G102-0423.2 G1020423	BL1392A1	B1.G102-0403.2 G1020403
BL1167A3	B1.G102-0010.2 G1020010	BL1255B2	B1.G102-0423.2 G1020423	BL1399A1	B1.G102-0408.2 G1020408
BL1167B3	B1.G102-0010.2 G1020010	BL1257A2	B1.G102-0269.2 G1020269	BL1399A2	B1.G102-0409.2 G1020409
BL1168A3	B1.G102-0344.2 G1020344	BL1257A2	B1.G102-0275.2 G1020275	BL1400A1	B1.G102-0355.2 G1020355
BL1168B3	B1.G102-0344.2 G1020344	BL1260A2	B1.G102-0258.2 G1020258	BL1400B1	B1.G102-0355.2 G1020355
BL1169A3	B1.G102-0009.2 G1020009	BL1260B2	B1.G102-0258.2 G1020258	BL1403A1	B1.G102-0658.2 G1020658
BL1169B3	B1.G102-0009.2 G1020009	BL1263A2	B1.G102-0339.2 G1020339	BL1404A3	B1.G102-0457.2 G1020457
BL1170A3	B1.G102-0025.2 G1020025	BL1263B2	B1.G102-0339.2 G1020339	BL1404A3	B1.G102-0779.2 G1020779
BL1170B3	B1.G102-0025.2 G1020025	BL1264A1	B1.G102-0332.2 G1020333	BL1405A2	B1.G102-0342.2 G1020342
BL1174B2	B1.G102-0015.2 G1020015	BL1264B1	B1.G102-0332.2 G1020333	BL1406A1	B1.G102-0351.2 G1020351
BL1175A4	B1.G102-0197.2 G1020197	BL1277A2	B1.G102-0956.2 G1020956	BL1406A2	B1.G102-0340.2 G1020340
BL1175B4	B1.G102-0197.2 G1020197	BL1278A2	B1.G102-0291.2 G1020291	BL1406F5	B1.G102-0351.2 G1020351
BL1176A1	B1.G102-0026.2 G1020026	BL1279A3	B1.G102-0373.2 G1020373	BL1438A2	B1.G102-0742.2 G1020742
BL1185A2	B1.G102-0015.2 G1020015	BL1279A3	B1.G102-0487.2 G1020487	BL1439A2	B1.G102-0891.2 G1020891
BL1187A1	B1.G102-0141.2 G1020141	BL1279F5	B1.G102-0373.2 G1020373	BL1440A2	B1.G102-0396.2 G1020396
BL1187A2	B1.G102-0141.2 G1020141	BL1281A2	B1.G102-0367.2 G1020367	BL1441A2	B1.G102-0397.2 G1020397
BL1187B2	B1.G102-0141.2 G1020141	BL1282A2	B1.G102-0608.2 G1020608	BL1467A2	B1.G102-0395.2 G1020395
BL1193A3	B1.G102-0201.2 G1020201	BL1287A2	B1.G102-0400.2 G1020400	BL1470A2	B1.G102-0411.2 G1020411
BL1193A3	B1.G102-0676.2 G1020676	BL1299A1	B1.G102-0317.2 G1020317	BL1471A2	B1.G102-0415.2 G1020415
BL1194A3	B1.G102-0345.2 G1020345	BL1299B1	B1.G102-0317.2 G1020317	BL1472A2	B1.G102-0683.2 G1020683
BL1194A3	B1.G102-0492.2 G1020492	BL1302A1	B1.G102-0259.2 G1020259	BL1474A3	B1.G102-0444.2 G1020444
BL1194A3	B1.G102-0549.2 G1020549	BL1311A1	B1.G102-0955.2 G1020955	BL1475A3	B1.G102-0421.2 G1020421
BL1194A4	B1.G102-0564.2 G1020564	BL1313A2	B1.G102-0326.2 G1020326	BL1475A4	B1.G102-0511.2 G1020511
BL1198A1	B1.G102-0028.2 G1020028	BL1315A1	B1.G102-0320.2 G1020320	BL1475B3	B1.G102-0421.2 G1020421
BL1200A2	B1.G102-0214.2 G1020214	BL1316A1	B1.G102-0369.2 G1020369	BL1475B4	B1.G102-0511.2 G1020511
BL1200A2	B1.G102-0215.2 G1020215	BL1318A2	B1.G102-0292.2 G1020292	BL1476A1	B1.G102-0419.2 G1020419
BL1200B2	B1.G102-0214.2 G1020214	BL1319A1	B1.G102-0305.2 G1020305	BL1476A2	B1.G102-0534.2 G1020534
BL1200B2	B1.G102-0215.2 G1020215	BL1319A1	B1.G102-0621.2 G1020621	BL1477A1	B1.G102-0312.2 G1020312
BL1201A2	B1.G102-0295.2 G1020295	BL1319A2	B1.G102-0298.2 G1020298	BL1477A2	B1.G102-0557.2 G1020557
BL1202A2	B1.G102-0296.2 G1020296	BL1320A4	B1.G102-0337.2 G1020337	BL1478A1	B1.G102-0290.2 G1020290

# Cross reference list



Liste des correspondances / Tabella di conversione codici / Lista de comparação /  
Lista porównawcza numerów / Porovnávací seznam čísel

FTE		FTE		FTE	
BL1480A1	B1.G102-0332.2 G1020333	BL1733A1	B1.G102-0584.2 G1020584	BL1815A1	B1.G102-0692.2 G1020692
BL1480B1	B1.G102-0332.2 G1020333	BL1734A3	B1.G102-0513.2 G1020513	BL1817A2	B1.G102-0650.2 G1020650
BL1481A1	B1.G102-0334.2 G1020334	BL1735A2	B1.G102-0882.2 G1020882	BL1818A2	B1.G102-0756.2 G1020756
BL1481B1	B1.G102-0334.2 G1020334	BL1737A2	B1.G102-0883.2 G1020883	BL1819A2	B1.G102-0882.2 G1020882
BL1482A2	B1.G102-0350.2 G1020350	BL1738A2	B1.G102-0591.2 G1020591	BL1821A3	B1.G102-0627.2 G1020627
BL1483A3	B1.G102-0570.2 G1020570	BL1739A2	B1.G102-0545.2 G1020545	BL1822A2	B1.G102-0709.2 G1020709
BL1483A4	B1.G102-0451.2 G1020451	BL1740A1	B1.G102-0441.2 G1020441	BL1823A2	B1.G102-0710.2 G1020710
BL1484A1	B1.G102-0293.2 G1020293	BL1741A2	B1.G102-0583.2 G1020583	BL1824A2	B1.G102-0711.2 G1020711
BL1485A1	B1.G102-0443.2 G1020443	BL1742A1	B1.G102-0469.2 G1020469	BL1825A1	B1.G102-0624.2 G1020624
BL1487A4	B1.G102-0363.2 G1020363	BL1743A1	B1.G102-0484.2 G1020484	BL1828A3	B1.G102-0610.2 G1020610
BL1489A2	B1.G102-0219.2 G1020219	BL1744A2	B1.G102-0574.2 G1020574	BL1829A4	B1.G102-0632.2 G1020632
BL1490A4	B1.G102-0458.2 G1020458	BL1745A2	B1.G102-0642.2 G1020642	BL1830A4	B1.G102-0677.2 G1020677
BL1490A4	B1.G102-0780.2 G1020780	BL1747A2	B1.G102-0575.2 G1020575	BL1831A2	B1.G102-0652.2 G1020652
BL1499A2	B1.G120-1056.2 G1201056	BL1750A3	B1.G102-0544.2 G1020544	BL1832A2	B1.G102-0648.2 G1020648
BL1500A1	B1.G120-5404.2 G1205404	BL1750A3	B1.G102-0852.2 G1020852	BL1833A2	B1.G102-0765.2 G1020765
BL1524A1	B1.G102-0379.2 G1020379	BL1751A2	B1.G102-0316.2 G1020316	BL1838A2	B1.G102-0644.2 G1020644
BL1524A2	B1.G102-0512.2 G1020512	BL1752A1	B1.G102-0562.2 G1020562	BL1840A4	B1.G102-0595.2 G1020595
BL1525A1	B1.G102-0390.2 G1020390	BL1753A4	B1.G102-0560.2 G1020560	BL1841A1	B1.G102-0901.2 G1020901
BL1525B1	B1.G102-0390.2 G1020390	BL1755A2	B1.G102-0527.2 G1020527	BL1843A1	B1.G102-0568.2 G1020568
BL1526A2	B1.G102-0542.2 G1020542	BL1769A4	B1.G102-0597.2 G1020597	BL1844A1	B1.G102-0515.2 G1020515
BL1527A2	B1.G102-0550.2 G1020550	BL1770A1	B1.G102-0448.2 G1020448	BL1845A2	B1.G102-0714.2 G1020714
BL1531A2	B1.G102-0459.2 G1020459	BL1771A3	B1.G102-0658.2 G1020658	BL1846A4	B1.G102-0566.2 G1020566
BL1538A3	B1.G102-0359.2 G1020359	BL1771A4	B1.G102-0654.2 G1020654	BL1850A3	B1.G102-0721.2 G1020721
BL1593A3	B1.G102-0510.2 G1020510	BL1771A4	B1.G102-0658.2 G1020658	BL1857A3	B1.G102-0614.2 G1020614
BL1612A2	B1.G102-0608.2 G1020608	BL1772A3	B1.G102-0658.2 G1020658	BL1857A4	B1.G102-0503.2 G1020503
BL1613A2	B1.G102-0316.2 G1020316	BL1773A4	B1.G102-0654.2 G1020654	BL1858A4	B1.G102-0504.2 G1020504
BL1614A1	B1.G102-0331.2 G1020331	BL1774A2	B1.G102-0580.2 G1020580	BL1859A4	B1.G102-0516.2 G1020516
BL1614A2	B1.G102-0463.2 G1020463	BL1776A1	B1.G102-0467.2 G1020467	BL1860A4	B1.G102-0517.2 G1020517
BL1614B1	B1.G102-0331.2 G1020331	BL1777A1	B1.G102-0519.2 G1020519	BL1861A3	B1.G102-0518.2 G1020518
BL1617A4	B1.G102-0313.2 G1020313	BL1778A4	B1.G102-0605.2 G1020605	BL1864A2	B1.G102-0593.2 G1020593
BL1644A2	B1.G102-0368.2 G1020368	BL1780A1	B1.G102-0633.2 G1020633	BL1866A2	B1.G102-0478.2 G1020478
BL1651A1	B1.G102-0422.2 G1020422	BL1780A2	B1.G102-0459.2 G1020459	BL1870A2	B1.G102-0707.2 G1020707
BL1652A4	B1.G102-0497.2 G1020497	BL1781A3	B1.G102-0576.2 G1020576	BL1871A2	B1.G102-0706.2 G1020706
BL1657A3	B1.G102-0384.2 G1020384	BL1782A3	B1.G102-0547.2 G1020547	BL1872A3	B1.G102-0758.2 G1020758
BL1662A2	B1.G102-0427.2 G1020427	BL1783A3	B1.G102-0548.2 G1020548	BL1872A3	B1.G102-0759.2 G1020759
BL1664A2	B1.G102-0389.2 G1020389	BL1784A1	B1.G102-0470.2 G1020470	BL1872A4	B1.G102-0691.2 G1020691
BL1665A1	B1.G102-0505.2 G1020505	BL1785A3	B1.G102-0271.2 G1020271	BL1873A4	B1.G102-0733.2 G1020733
BL1665B1	B1.G102-0505.2 G1020505	BL1786A2	B1.G102-0646.2 G1020646	BL1874A2	B1.G102-0586.2 G1020586
BL1666A3	B1.G102-0507.2 G1020507	BL1787U2	B1.G120-5215.2 G1205215	BL1874A2	B1.G102-0848.2 G1020848
BL1672A2	B1.G102-0357.2 G1020357	BL1789U1	B1.G120-5203.2 G1205203	BL1875A2	B1.G102-0588.2 G1020588
BL1678A1	B1.G102-0441.2 G1020441	BL1790A3	B1.G102-0563.2 G1020563	BL1876A3	B1.G102-0538.2 G1020538
BL1679A2	B1.G102-0442.2 G1020442	BL1794A3	B1.G102-0735.2 G1020735	BL1876A3	B1.G102-0741.2 G1020741
BL1680A2	B1.G102-0582.2 G1020582	BL1795A4	B1.G102-0483.2 G1020483	BL1876A4	B1.G120-1059.2 G1201059
BL1684A2	B1.G102-0554.2 G1020554	BL1796A4	B1.G102-0740.2 G1020740	BL1878A2	B1.G102-0712.2 G1020712
BL1685A4	B1.G102-0537.2 G1020537	BL1797A2	B1.G102-0634.2 G1020634	BL1881A2	B1.G102-0713.2 G1020713
BL1690A2	B1.G102-0642.2 G1020642	BL1798A2	B1.G102-0637.2 G1020637	BL1886A1	B1.G120-5366.2 G1205366
BL1691A4	B1.G102-0540.2 G1020540	BL1799A2	B1.G102-0638.2 G1020638	BL1887U1	B1.G120-5234.2 G1205234
BL1694A2	B1.G102-0392.2 G1020392	BL1800A3	B1.G102-0686.2 G1020686	BL1889A3	B1.G102-0885.2 G1020885
BL1695A4	B1.G102-0440.2 G1020440	BL1801A3	B1.G102-0687.2 G1020687	BL1889A4	B1.G102-0886.2 G1020886
BL1696A4	B1.G102-0440.2 G1020440	BL1803A4	B1.G102-0602.2 G1020602	BL1890A3	B1.G102-0529.2 G1020529
BL1696A4	B1.G120-1272.2 G1201272	BL1804A4	B1.G102-0603.2 G1020603	BL1892A3	B1.G102-0513.2 G1020513
BL1716A1	B1.G102-0578.2 G1020578	BL1805A1	B1.G102-0604.2 G1020604	BL1894A4	B1.G102-0514.2 G1020514
BL1717A1	B1.G102-0480.2 G1020480	BL1808A2	B1.G120-5344.2 G1205344	BL1895A2	B1.G102-0680.2 G1020680
BL1727A2	B1.G102-0258.2 G1020258	BL1810A2	B1.G120-5230.2 G1205230	BL1896A4	B1.G102-0682.2 G1020682
BL1728A3	B1.G102-0569.2 G1020569	BL1812A4	B1.G102-0482.2 G1020482	BL1896A4	B1.G102-0734.2 G1020734
BL1731A4	B1.G102-0924.2 G1020924	BL1813A1	B1.G102-0496.2 G1020496	BL1900A3	B1.G102-0685.2 G1020685
BL1732A4	B1.G102-0925.2 G1020925	BL1814A1	B1.G102-0567.2 G1020567	BL1901A2	B1.G120-5418.2 G1205418

# Cross reference list

Liste des correspondances / Tabella di conversione codici / Lista de comparação /

Lista porównawcza numerów / Porovnávací seznam čísel



FTE 	FTE 	FTE 
BL1904A2	B1.G102-0719.2 G1020719	BS3447 B1.G209-0120.1 G2109120
BL1905A3	B1.G102-0721.2 G1020721	BS3449 B1.G208-0104.1 G2108104
BL1906A2	B1.G102-0754.2 G1020754	BS3477 B1.G210-0187.1 G2110187
BL1907A4	B1.G102-0615.2 G1020615	BS3503 B1.G222-0145.1 G2122145
BL1908A2	B1.G102-0500.2 G1020500	BS3504 B1.G210-0209.1 G2110209
BL1910A1	B1.G102-0622.2 G1020622	BS3505 B1.G208-0107.1 G2108107
BL1911A3	B1.G102-0549.2 G1020549	BS3508 B1.G220-0133.1 G2120133
BL1916A2	B1.G120-5241.2 G1205241	BS3511 B1.G212-0127.1 G2112127
BL1921A1	B1.G120-5242.2 G1205242	BS3546 B1.G220-0125.1 G2120125
BL1923A2	B1.G120-5333.2 G1205333	BS3583 B1.G210-0115.1 G2110115
BL1926A4	B1.G102-0891.2 G1020891	BS3589 B1.G210-0178.1 G2110178
BL1928A3	B1.G102-0573.2 G1020573	BS3593 B1.G220-0142.1 G2120142
BL1936A3	B1.G102-0573.2 G1020573	BS3605 B1.G220-0128.1 G2120128
BL1937A3	B1.G102-0613.2 G1020613	BS3611 B1.G210-0196.1 G2110196
BL1938A4	B1.G102-0794.2 G1020794	BS3649 B1.G210-0212.1 G2110212
BL1942A2	B1.G102-0812.2 G1020812	BS3680 B1.G224-0115.1 G2124115
BL1951A4	B1.G102-0751.2 G1020751	BS3688 B1.G220-0132.1 G2120132
BL1952A4	B1.G102-0752.2 G1020752	BS3712 B1.G210-0111.1 G2110111
BL1953A2	B1.G120-1047.2 G1201047	BS3713 B1.G213-0178.1 G2113178
BL1958A3	B1.G102-0572.2 G1020572	BS3727 B1.G220-0147.1 G2120147
BL1959A2	B1.G102-0662.2 G1020662	BS3766 B1.G222-0147.1 G2122147
BL1960A2	B1.G102-0663.2 G1020663	BS3786 B1.G208-0106.1 G2108106
BL1966A1	B1.G102-0670.2 G1020670	BS3792 B1.G210-0215.1 G2110215
BL1966A1	B1.G102-0727.2 G1020727	BS3803 B1.G212-0126.1 G2112126
BL1967A4	B1.G102-0605.2 G1020605	BS3804 B1.G222-0115.1 G2122115
BL1968A3	B1.G102-0625.2 G1020625	BS3805 B1.G210-0202.1 G2110202
BL1980A2	B1.G120-1025.2 G1201025	BS3820 B1.G212-0137.1 G2112137
BL1981A2	B1.G120-1033.2 G1201033	BS3824 B1.G215-0105.1 G2115105
BL1982A2	B1.G120-1035.2 G1201035	BS3825 B1.G225-0105.1 G2125105
BL1988A2	B1.G102-0862.2 G1020862	BS3826 B1.G220-0140.1 G2120140
BL1989A2	B1.G102-0659.2 G1020659	BS3840 B1.G209-0120.1 G2109120
BL1996A2	B1.G120-1066.2 G1201066	BS3899 B1.G221-0106.1 G2121106
BL2002A2	B1.G102-0850.2 G1020850	BS3909 B1.G224-0120.1 G2124120
BL2010A4	B1.G102-0858.2 G1020858	BS3910 B1.G220-0146.1 G2120146
BL2016A4	B1.G102-0774.2 G1020774	BS3929 B1.G210-0201.1 G2110201
BL2018A4	B1.G102-0763.2 G1020763	BS3935 B1.G210-0261.1 G2110261
BL2019A4	B1.G102-0872.2 G1020872	BS3953 B1.G224-0131.1 G2124131
BL2022A3	B1.G102-0730.2 G1020730	BS4254 B1.G208-0108.1 G2108108
BL2027A4	B1.G102-0933.2 G1020933	BS4338 B1.G222-0148.1 G2122148
BL2028A4	B1.G102-0934.2 G1020934	BS4349 B1.G210-0213.1 G2110213
BL2041A2	B1.G102-0746.2 G1020746	BS4361 B1.G224-0127.1 G2124127
BL2043A4	B1.G102-0801.2 G1020801	BS4362 B1.G224-0138.1 G2124138
BL2044A4	B1.G102-0800.2 G1020800	BS4367 B1.G210-0213.1 G2110213
BL2045A4	B1.G102-0802.2 G1020802	BS4369 B1.G210-0212.1 G2110212
BL2046A1	B1.G102-0889.2 G1020889	BS4372 B1.G221-0105.1 G2121105
BL2048A3	B1.G120-1135.2 G1201135	BS4402 B1.G208-0108.1 G2108108
BL2049A3	B1.G102-0787.2 G1020787	BS4406 B1.G224-0171.1 G2124171
BL2049A3	B1.G102-0900.2 G1020900	BS4441 B1.G208-0109.1 G2108109
BL2057A2	B1.G102-0999.2 G1020999	BS4503 B1.G210-0232.1 G2110232
BL2058A2	B1.G120-1079.2 G1201079	BS4512 B1.G212-0131.1 G2112131
BS1010	B1.G210-0151.1 G2110151	BS4527 B1.G210-0115.1 G2110115
BS1046	B1.G212-0106.1 G2112106	BS4533 B1.G213-0181.1 G2113181
BS3205	B1.G220-0115.1 G2120115	BS4535 B1.G210-0211.1 G2110211
BS3249	B1.G212-0116.1 G2112116	BS4536 B1.G219-0107.1 G2119107
BS3309	B1.G220-0123.1 G2120123	BS4539 B1.G225-0110.1 G2125110
BS3388	B1.G213-0161.1 G2113161	BS4541 B1.G210-0217.1 G2110217
BS3442	B1.G210-0190.1 G2110190	BS4544 B1.G222-0161.1 G2122161
		BS4548 B1.G218-0106.1 G2118106
		BS4552 B1.G210-0210.1 G2110210
		BS4577 B1.G212-0141.1 G2112141
		BS4578 B1.G213-0181.1 G2113181
		BS4581 B1.G212-0131.1 G2112131
		BS4583 B1.G224-0131.1 G2124131
		BS4596 B1.G210-0225.1 G2110225
		BS4607 B1.G213-0182.1 G2113182
		BS4615 B1.G225-0124.1 G2125124
		BS4620 B1.G220-0155.1 G2120155
		BS4623 B1.G222-0159.1 G2122159
		BS4627 B1.G210-0223.1 G2110223
		BS4628 B1.G225-0114.1 G2125114
		BS4634 B1.G210-0229.1 G2110229
		BS4662 B1.G226-0106.1 G2126106
		BS4663 B1.G210-0230.1 G2110230
		BS4668 B1.G222-0150.1 G2122150
		BS4669 B1.G222-0151.1 G2122151
		BS4673 B1.G209-0114.1 G2109114
		BS4673B B1.G209-0114.1 G2109114
		BS4674 B1.G222-0197.1 G2122197
		BS4676 B1.G213-0184.1 G2113184
		BS4678 B1.G225-0119.1 G2125119
		BS4727 B1.G222-0172.1 G2122172
		BS4731 B1.G225-0115.1 G2125115
		BS4733 B1.G212-0138.1 G2112138
		BS4735 B1.G225-0113.1 G2125113
		BS4738 B1.G208-0109.1 G2108109
		BS4740 B1.G213-0185.1 G2113185
		BS4745 B1.G212-0144.1 G2112144
		BS4752 B1.G222-0152.1 G2122152
		BS4753 B1.G209-0123.1 G2109123
		BS4763 B1.G209-0133.1 G2109133
		BS4764 B1.G222-0163.1 G2122163
		BS4768 B1.G225-0123.1 G2125123
		BS4813 B1.G224-0152.1 G2124152
		BS4814 B1.G225-0131.1 G2125131
		BS4815 B1.G210-0251.1 G2110251
		BS4816 B1.G210-0250.1 G2110250
		BS5010 B1.G225-0137.1 G2125137
		BS5042 B1.G213-0195.1 G2113195
		BS5043 B1.G209-0124.1 G2109124
		BS5117 B1.G218-0131.1 G2118131
		BS5143 B1.G224-0158.1 G2124158
		BS5146 B1.G222-0160.1 G2122160
		BS5147 B1.G219-0108.1 G2119108
		BS5157 B1.G209-0136.1 G2109136
		BS5182 B1.G210-0258.1 G2110258
		BS5194 B1.G220-0175.1 G2120175
		BS5199 B1.G224-0161.1 G2124161
		BS5207 B1.G232-0115.1 G2132115
		BS5208 B1.G228-0125.1 G2128125
		BS5219 B1.G224-0166.1 G2124166
		BS5221 B1.G212-0154.1 G2112154
		BS5228 B1.G225-0138.1 G2125138
		BS5231 B1.G232-0114.1 G2132114
		BS5238 B1.G210-0285.1 G2110285



# Cross reference list

Liste des correspondances / Tabella di conversione codici / Lista de comparação /



Lista porównawcza numerów / Porovnávací seznam čísel

FTE		FTE		HONDA	
BS5240	B1.G222-0194.1 G2122194	BS7013	B1.G210-0225.1 G2110225	45022-SMG-E01	B1.G120-1013.2 G1201013
BS5241	B1.G226-0120.1 G2126120	BS7023	B1.G222-0159.1 G2122159	45022-SMT-E00	B1.G120-5344.2 G1205344
BS5276	B1.G225-0142.1 G2125142	BS7027	B1.G213-0182.1 G2113182	45022-SR3-V01	B1.G102-0722.2 G1020722
BS5278	B1.G230-0113.1 G2130113	BS7028	B1.G225-0113.1 G2125113	45022-SR3-V10	B1.G102-0722.2 G1020722
BS5282	B1.G218-0137.1 G2118137	BS7029	B1.G222-0151.1 G2122151	45022-SR3-V11	B1.G102-0722.2 G1020722
BS5306	B1.G211-0152.1 G2111152	BS7030	B1.G222-0150.1 G2122150	45022-SR3-V12	B1.G102-0722.2 G1020722
BS5307	B1.G210-0261.1 G2110261	BS7031	B1.G209-0123.1 G2109123	45022-SWW-G01	B1.G102-0817.2 G1020817
BS5311	B1.G209-0137.1 G2109137	BS7035	B1.G225-0114.1 G2125114	45251-S5D-A10	B1.G221-0105.1 G2121105
BS5312	B1.G222-0204.1 G2122204	BS7039	B1.G212-0138.1 G2112138	45251-S6D-E10	B1.G221-0105.1 G2121105
BS5313	B1.G210-0271.1 G2110271	BS7040	B1.G225-0115.1 G2125115	45251-SCC-900	B1.G221-0105.1 G2121105
BS5314	B1.G220-0174.1 G2120174	BS7041	B1.G222-0152.1 G2122152	45251-SK7-A00	B1.G221-0105.1 G2121105
BS5348	B1.G212-0155.1 G2112155	BS7042	B1.G210-0223.1 G2110223	45251-SK7-A10	B1.G221-0105.1 G2121105
BS5351	B1.G220-0115.1 G2120115	BS7062	B1.G210-0229.1 G2110229	45251-SK7-J00	B1.G221-0105.1 G2121105
BS5364	B1.G216-0124.1 G2116124	BS7068	B1.G212-0171.1 G2112171	45251-SR0-A00	B1.G221-0105.1 G2121105
BS5367	B1.G211-0154.1 G2111154	BS7072	B1.G228-0177.1 G2128177	45251-SR0-A10	B1.G221-0105.1 G2121105
BS5369	B1.G222-0216.1 G2122216	BS7076	B1.G224-0191.1 G2124191	45251-ST3-E10	B1.G221-0105.1 G2121105
BS5379	B1.G225-0155.1 G2125155	BS7081	B1.G230-0115.1 G2130115	45251-TF3-E00	B1.G221-0105.1 G2121105
BS5397	B1.G210-0302.1 G2110302	BS7094	B1.G225-0149.1 G2125149	45251-TG5-H00	B1.G221-0105.1 G2121105
BS5412	B1.G225-0141.1 G2125141	BS7095	B1.G230-0175.1 G2130175		
BS5413	B1.G212-0157.1 G2112157	BS7117	B1.G234-0100.1 G2134100	<b>HYUNDAI</b>	
BS5414	B1.G228-0176.1 G2128176	BS7121	B1.G210-0324.1 G2110324	51712-0X500	B1.G218-0145.1 G2118145
BS5415	B1.G210-0278.1 G2110278	BS7130	B1.G228-0203.1 G2128203	51712-1H000	B1.G226-0150.1 G2126150
BS5416	B1.G225-0158.1 G2125158	BS7135B	B1.G212-0184.1 G2112184	51712-1H100	B1.G226-0150.1 G2126150
BS5417	B1.G222-0210.1 G2122210	BS7214	B1.G225-0184.1 G2125184	58101-0XA01	B1.G120-1047.2 G1201047
BS5418	B1.G225-0145.1 G2125145	BS7214HB	B1.G225-0184.1 G2125184	58101-0XA10	B1.G120-1047.2 G1201047
BS5419	B1.G210-0277.1 G2110277	BS7272	B1.G224-0221.1 G2124221	58101-1GE00	B1.G120-1033.2 G1201033
BS5420	B1.G220-0184.1 G2120184			58101-1HA00	B1.G120-1002.2 G1201002
BS5423	B1.G212-0158.1 G2112158	<b>HONDA</b>		58101-1HA10	B1.G120-1002.2 G1201002
BS5424	B1.G230-0114.1 G2130114	42510-SE0-000	B1.G210-0212.1 G2110212	58101-1HA20	B1.G120-1002.2 G1201002
BS5431	B1.G224-0169.1 G2124169	42510-SE0-010	B1.G210-0212.1 G2110212	58101-1JA10	B1.G120-1033.2 G1201033
BS5432	B1.G212-0162.1 G2112162	42510-SH3-G00	B1.G210-0212.1 G2110212	58101-1JA60	B1.G120-1047.2 G1201047
BS5435	B1.G222-0238.1 G2122238	42510-SK3-305	B1.G210-0212.1 G2110212	58302-1GA00	B1.G120-1035.2 G1201035
BS5436	B1.G220-0195.1 G2120195	42510-SK3-E00	B1.G210-0212.1 G2110212	58302-1HA10	B1.G120-1035.2 G1201035
BS5439	B1.G208-0113.1 G2108113	43022-S04-E00	B1.G120-1000.2 G1201000	58302-1JA30	B1.G120-1035.2 G1201035
BS5440	B1.G222-0232.1 G2122232	43022-S04-E01	B1.G120-1000.2 G1201000	58302-2SA30	B1.G120-1035.2 G1201035
BS5455	B1.G225-0148.1 G2125148	43022-S04-E03	B1.G120-1000.2 G1201000	58302-2SA70	B1.G120-1035.2 G1201035
BS5455	B1.G225-0198.1 G2125198	43022-SAA-E51	B1.G120-1000.2 G1201000	58302-2YA30	B1.G120-1035.2 G1201035
BS5464	B1.G228-0176.1 G2128176	43022-SMG-E00	B1.G120-1014.2 G1201014	58302-3SA20	B1.G120-1035.2 G1201035
BS5465	B1.G228-0142.1 G2128142	43022-SMG-E01	B1.G120-1014.2 G1201014	58411-0X500	B1.G210-0324.1 G2110324
BS5469	B1.G228-0132.1 G2128132	43022-SMG-E02	B1.G120-1014.2 G1201014	58411-1C800	B1.G210-0312.1 G2110312
BS5473	B1.G222-0211.1 G2122211	43022-SMG-E03	B1.G120-1014.2 G1201014		
BS5482	B1.G209-0139.1 G2109139	43022-SWW-G01	B1.G102-0819.2 G1020819	<b>IVECO</b>	
BS5486	B1.G225-0117.1 G2125117	43022-SWW-G02	B1.G102-0819.2 G1020819	1906401	B1.G102-0357.2 G1020357
BS5487	B1.G225-0162.1 G2125162	43022-TF0-G00	B1.G120-1000.2 G1201000	2992339	B1.G102-0357.2 G1020357
BS5487	B1.G228-0154.1 G2128154	43022-TF0-G01	B1.G120-1000.2 G1201000	2995633	B1.G102-0357.2 G1020357
BS5489	B1.G211-0158.1 G2111158	45022-S04-V10	B1.G102-0722.2 G1020722	2995693	B1.G102-0357.2 G1020357
BS5490	B1.G225-0165.1 G2125165	45022-S2A-E01	B1.G120-5344.2 G1205344	2996091	B1.G102-0357.2 G1020357
BS5491	B1.G211-0164.1 G2111164	45022-S2A-E50	B1.G120-5344.2 G1205344	2996465	B1.G102-0357.2 G1020357
BS5492	B1.G225-0170.1 G2125170	45022-S5A-E50	B1.G102-0722.2 G1020722	2996535	B1.G102-0357.2 G1020357
BS5495	B1.G212-0169.1 G2112169	45022-S5A-G00	B1.G102-0722.2 G1020722	2996605	B1.G102-0357.2 G1020357
BS5496	B1.G228-0164.1 G2128164	45022-S5A-G01	B1.G102-0722.2 G1020722	42535791	B1.G102-0357.2 G1020357
BS5497	B1.G225-0155.1 G2125155	45022-S5A-E00	B1.G102-0722.2 G1020722	42555881	B1.G102-0828.2 G1020828
BS5505	B1.G211-0155.1 G2111155	45022-S5T-E00	B1.G120-5344.2 G1205344	42555917	B1.G102-0825.2 G1020825
BS5518	B1.G220-0180.1 G2120180	45022-S5T-E50	B1.G120-5344.2 G1205344		
BS5562	B1.G228-0154.1 G2128154	45022-S5T-E51	B1.G120-5344.2 G1205344		
BS5562H	B1.G228-0154.1 G2128154	45022-SEA-E01	B1.G102-0812.2 G1020812		
BS7003	B1.G226-0106.1 G2126106	45022-SMG-E00	B1.G120-1013.2 G1201013		

# Cross reference list

Liste des correspondances / Tabella di conversione codici / Lista de comparação /



Lista porównawcza numerów / Porovnávací seznam čísel

JAGUAR 		JURID 		JURID 	
C2S 17129	B1.G102-0562.2 G1020562	21 144 00 4 529	B1.G102-0246.2 G1020246	561678J	B1.G224-0120.1 G2124120
C2S 17362	B1.G102-0563.2 G1020563	21 171 00 4 435	B1.G102-0423.2 G1020423	561679J	B1.G220-0146.1 G2120146
C2S 20893	B1.G102-0563.2 G1020563	21 197 00 9 438	B1.G102-0339.2 G1020339	561698J	B1.G209-0120.1 G2109120
C2S 33408	B1.G102-0563.2 G1020563	21 201 00 4 100	B1.G102-0258.2 G1020258	561698JC	B1.G209-0120.1 G2109120
C2S 35270	B1.G224-0161.1 G2124161	21 202 00 4 435	B1.G102-0332.2 G1020333	561709J	B1.G210-0213.1 G2110213
C2S 35271	B1.G212-0154.1 G2112154	21 276 00 4 518	B1.G102-0291.2 G1020291	561733J	B1.G208-0108.1 G2108108
C2S 38068	B1.G102-0625.2 G1020625	21 305 00 4 166	B1.G102-0400.2 G1020400	561822J	B1.G225-0124.1 G2125124
C2S 42667	B1.G224-0161.1 G2124161	21 353 00 4 171	B1.G102-0317.2 G1020317	561861J	B1.G220-0142.1 G2120142
C2S 42668	B1.G212-0154.1 G2112154	561087J	B1.G210-0151.1 G2110151	561863J	B1.G210-0261.1 G2110261
C2S 4566	B1.G224-0161.1 G2124161	561141J	B1.G212-0106.1 G2112106	561868J	B1.G208-0109.1 G2108109
C2S 49730	B1.G212-0154.1 G2112154	561158J	B1.G213-0161.1 G2113161	561870J	B1.G212-0131.1 G2112131
C2S 9231	B1.G212-0154.1 G2112154	561178J	B1.G220-0123.1 G2120123	561960J	B1.G225-0119.1 G2125119
		561235J	B1.G212-0116.1 G2112116	561961J	B1.G210-0225.1 G2110225
<b>JEEP</b>		561248J	B1.G220-0115.1 G2120115	561963J	B1.G209-0114.1 G2109114
0 5019 805AA	B1.G120-5234.2 G1205234	561253J	B1.G210-0187.1 G2110187	561963JC	B1.G209-0114.1 G2109114
0 5066 427AA	B1.G120-5238.2 G1205238	561257J	B1.G208-0104.1 G2108104	561965J	B1.G222-0161.1 G2122161
0 5071 948AA	B1.G120-5234.2 G1205234	561312J	B1.G210-0178.1 G2110178	561969J	B1.G224-0138.1 G2124138
0 5191 229AA	B1.G120-5241.2 G1205241	561329J	B1.G210-0190.1 G2110190	561979J	B1.G213-0181.1 G2113181
0 6802 0494AB	B1.G120-5241.2 G1205241	561333J	B1.G209-0120.1 G2109120	561980J	B1.G210-0232.1 G2110232
0 6802 8671AA	B1.G120-5230.2 G1205230	561336J	B1.G220-0125.1 G2120125	561981J	B1.G218-0106.1 G2118106
5019 805AA	B1.G120-5234.2 G1205234	561340J	B1.G210-0209.1 G2110209	561982J	B1.G210-0210.1 G2110210
5066 427AA	B1.G120-5238.2 G1205238	561359J	B1.G208-0107.1 G2108107	561982JC	B1.G210-0210.1 G2110210
5071 948AA	B1.G120-5234.2 G1205234	561364J	B1.G220-0133.1 G2120133	561984J	B1.G224-0127.1 G2124127
5191 229AA	B1.G120-5241.2 G1205241	561375J	B1.G210-0115.1 G2110115	561997J	B1.G221-0106.1 G2121106
6802 0494AB	B1.G120-5241.2 G1205241	561383J	B1.G210-0212.1 G2110212	562003J	B1.G219-0107.1 G2119107
6802 8671AA	B1.G120-5230.2 G1205230	561387J	B1.G222-0147.1 G2122147	562003JC	B1.G219-0107.1 G2119107
K68020494AB	B1.G120-5241.2 G1205241	561409J	B1.G220-0132.1 G2120132	562006J	B1.G212-0127.1 G2112127
		561448J	B1.G220-0128.1 G2120128	562007J	B1.G210-0211.1 G2110211
		561460J	B1.G210-0111.1 G2110111	562013J	B1.G225-0110.1 G2125110
<b>JURID</b>		561468J	B1.G220-0142.1 G2120142	562013JC	B1.G225-0110.1 G2125110
2907603010	B1.G102-0891.2 G1020891	561469J	B1.G212-0127.1 G2112127	562014J	B1.G210-0217.1 G2110217
20 168 00 4 526	B1.G102-0274.2 G1020274	561488J	B1.G224-0115.1 G2124115	562014JC	B1.G210-0217.1 G2110217
20 168 66 4 499	B1.G102-0273.2 G1020273	561491J	B1.G213-0178.1 G2113178	562019J	B1.G226-0106.1 G2126106
20 181 00 4 191	B1.G102-0316.2 G1020316	561496J	B1.G210-0196.1 G2110196	562032J	B1.G210-0215.1 G2110215
20 228 00 4 510	B1.G102-0097.2 G1020097	561513J	B1.G220-0147.1 G2120147	562033J	B1.G220-0155.1 G2120155
20 640 00 4 510	B1.G102-0334.2 G1020334	561520J	B1.G222-0145.1 G2122145	562035J	B1.G222-0159.1 G2122159
20 652 00 4 584	B1.G102-0315.2 G1020315	561547J	B1.G215-0105.1 G2115105	562035JC	B1.G222-0159.1 G2122159
20 678 00 4 437	B1.G102-0311.2 G1020311	561547JC	B1.G215-0105.1 G2115105	562038J	B1.G212-0141.1 G2112141
20 687 00 4 493	B1.G102-0022.2 G1020022	561548J	B1.G225-0105.1 G2125105	562039J	B1.G222-0150.1 G2122150
20 775 00 4 510	B1.G102-0141.2 G1020141	561548JC	B1.G225-0105.1 G2125105	562040J	B1.G222-0151.1 G2122151
20 787 00 4 510	B1.G102-0147.2 G1020147	561549J	B1.G210-0201.1 G2110201	562041J	B1.G225-0113.1 G2125113
20 887 00 4 518	B1.G102-0010.2 G1020010	561549JC	B1.G210-0201.1 G2110201	562042J	B1.G210-0230.1 G2110230
20 887 44 4 518	B1.G102-0009.2 G1020009	561550J	B1.G212-0126.1 G2112126	562043J	B1.G225-0114.1 G2125114
20 889 00 4 518	B1.G102-0025.2 G1020025	561551J	B1.G222-0115.1 G2122115	562044J	B1.G213-0184.1 G2113184
20 939 00 4 170	B1.G102-0015.2 G1020015	561551JC	B1.G222-0115.1 G2122115	562045J	B1.G220-0133.1 G2120133
20 939 00 4 510	B1.G102-0015.2 G1020015	561552J	B1.G210-0202.1 G2110202	562048J	B1.G212-0144.1 G2112144
20 961 00 4 436	B1.G102-0201.2 G1020201	561552JC	B1.G210-0202.1 G2110202	562052J	B1.G225-0115.1 G2125115
20 986 00 4 510	B1.G102-0214.2 G1020214	561555J	B1.G208-0106.1 G2108106	562052JC	B1.G225-0115.1 G2125115
20 996 00 4 547	B1.G102-0308.2 G1020308	561588J	B1.G220-0140.1 G2120140	562053J	B1.G209-0123.1 G2109123
21 026 00 4 525	B1.G102-0339.2 G1020339	561590J	B1.G221-0106.1 G2121106	562055J	B1.G213-0185.1 G2113185
21 028 00 4 495	B1.G102-0044.2 G1020044	561591J	B1.G208-0109.1 G2108109	562057J	B1.G210-0223.1 G2110223
21 050 00 4 438	B1.G102-0271.2 G1020271	561592J	B1.G222-0148.1 G2122148	562059J	B1.G210-0229.1 G2110229
21 055 00 4 512	B1.G102-0257.2 G1020257	561593J	B1.G224-0171.1 G2124171	562060J	B1.G222-0152.1 G2122152
21 064 03 4 595	B1.G102-0474.2 G1020474	561615J	B1.G210-0215.1 G2110215	562060JC	B1.G222-0152.1 G2122152
21 096 00 9 437	B1.G102-0219.2 G1020219	561624J	B1.G224-0131.1 G2124131	562069J	B1.G224-0152.1 G2124152
21 105 00 4 510	B1.G102-0184.2 G1020184	561630J	B1.G221-0105.1 G2121105	562070J	B1.G225-0131.1 G2125131
21 140 00 4 436	B1.G102-0272.2 G1020272	561663J	B1.G212-0137.1 G2112137	562071J	B1.G210-0251.1 G2110251
21 144 00 4 528	B1.G102-0246.2 G1020246				

# Cross reference list

Liste des correspondances / Tabella di conversione codici / Lista de comparação /



Lista porównawcza numerów / Porovnávací seznam čísel

JURID		JURID		JURID				
562072J	B1.G210-0250.1	G2110250	562270J	B1.G211-0154.1	G2111154	571331J	B1.G102-0323.2	G1020323
562073J	B1.G213-0182.1	G2113182	562271J	B1.G225-0149.1	G2125149	571332D	B1.G102-0214.2	G1020214
562078J	B1.G222-0172.1	G2122172	562274J	B1.G208-0113.1	G2108113	571332J	B1.G102-0214.2	G1020214
562081J	B1.G212-0138.1	G2112138	562277J	B1.G225-0158.1	G2125158	571333D	B1.G102-0214.2	G1020214
562089J	B1.G210-0258.1	G2110258	562278J	B1.G225-0148.1	G2125148	571333J	B1.G102-0214.2	G1020214
562090J	B1.G222-0160.1	G2122160	562287J	B1.G225-0124.1	G2125124	571334D	B1.G102-0216.2	G1020216
562090JC	B1.G222-0160.1	G2122160	562290J	B1.G220-0174.1	G2120174	571334D	B1.G102-0522.2	G1020522
562094J	B1.G219-0108.1	G2119108	562293J	B1.G212-0171.1	G2112171	571334J	B1.G102-0216.2	G1020216
562101J	B1.G232-0115.1	G2132115	562294J	B1.G228-0164.1	G2128164	571334J	B1.G102-0522.2	G1020522
562103J	B1.G224-0158.1	G2124158	562296J	B1.G220-0184.1	G2120184	571335D	B1.G102-0216.2	G1020216
562104J	B1.G224-0171.1	G2124171	562304J	B1.G222-0231.1	G2122231	571335J	B1.G102-0216.2	G1020216
562128J	B1.G222-0194.1	G2122194	562307J	B1.G218-0137.1	G2118137	571344J	B1.G102-0022.2	G1020022
562129J	B1.G226-0120.1	G2126120	562311J	B1.G220-0180.1	G2120180	571350J	B1.G102-0246.2	G1020246
562130J	B1.G209-0137.1	G2109137	562312J	B1.G222-0232.1	G2122232	571353D	B1.G102-0257.2	G1020257
562132J	B1.G225-0123.1	G2125123	562315J	B1.G225-0198.1	G2125198	571353J	B1.G102-0257.2	G1020257
562133J	B1.G222-0163.1	G2122163	562316J	B1.G220-0195.1	G2120195	571353J-AS	B1.G102-0257.2	G1020257
562138J	B1.G213-0195.1	G2113195	562317J	B1.G222-0238.1	G2122238	571355D	B1.G102-0474.2	G1020474
562139J	B1.G222-0204.1	G2122204	562331J	B1.G232-0144.1	G2132144	571355J	B1.G102-0474.2	G1020474
562155J	B1.G209-0136.1	G2109136	562341J	B1.G232-0114.1	G2132114	571355J-AS	B1.G102-0474.2	G1020474
562164J	B1.G212-0155.1	G2112155	562354J	B1.G228-0177.1	G2128177	571356D	B1.G102-0197.2	G1020197
562169J	B1.G218-0131.1	G2118131	562361J	B1.G211-0155.1	G2111155	571356J	B1.G102-0197.2	G1020197
562171J	B1.G209-0124.1	G2109124	562364J	B1.G225-0117.1	G2125117	571356J-AS	B1.G102-0197.2	G1020197
562177J	B1.G209-0133.1	G2109133	562429J	B1.G210-0324.1	G2110324	571357D	B1.G102-0274.2	G1020274
562178J	B1.G222-0197.1	G2122197	562529JC	B1.G224-0221.1	G2124221	571357J	B1.G102-0274.2	G1020274
562180J	B1.G224-0161.1	G2124161	567760J	B1.G222-0161.1	G2122161	571357J-AS	B1.G102-0274.2	G1020274
562182J	B1.G224-0169.1	G2124169	569122J	B1.G222-0161.1	G2122161	571361D	B1.G102-0201.2	G1020201
562188J	B1.G225-0138.1	G2125138	569136J	B1.G228-0203.1	G2128203	571361J	B1.G102-0201.2	G1020201
562192J	B1.G210-0261.1	G2110261	571221D	B1.G102-0097.2	G1020097	571361J-AS	B1.G102-0201.2	G1020201
562192JC	B1.G210-0261.1	G2110261	571221J	B1.G102-0097.2	G1020097	571363J	B1.G102-0329.2	G1020329
562193J	B1.G212-0154.1	G2112154	571224J	B1.G102-0065.2	G1020065	571367D	B1.G102-0269.2	G1020269
562194J	B1.G210-0271.1	G2110271	571276D	B1.G102-0015.2	G1020015	571367J	B1.G102-0269.2	G1020269
562195J	B1.G211-0152.1	G2111152	571276J	B1.G102-0015.2	G1020015	571367J-AS	B1.G102-0269.2	G1020269
562196J	B1.G224-0166.1	G2124166	571276J-AS	B1.G102-0015.2	G1020015	571376D	B1.G102-0273.2	G1020273
562199J	B1.G225-0137.1	G2125137	571297D	B1.G102-0141.2	G1020141	571376J	B1.G102-0273.2	G1020273
562202J	B1.G228-0125.1	G2128125	571297J	B1.G102-0141.2	G1020141	571376J-AS	B1.G102-0273.2	G1020273
562205J	B1.G230-0113.1	G2130113	571304J	B1.G102-0147.2	G1020147	571382D	B1.G102-0044.2	G1020044
562212J	B1.G228-0176.1	G2128176	571309J	B1.G102-0140.2	G1020140	571382J	B1.G102-0044.2	G1020044
562213J	B1.G210-0278.1	G2110278	571313J	B1.G102-0326.2	G1020326	571382J-AS	B1.G102-0044.2	G1020044
562215J	B1.G216-0124.1	G2116124	571315D	B1.G102-0025.2	G1020025	571387J	B1.G102-0308.2	G1020308
562216J	B1.G225-0141.1	G2125141	571315J	B1.G102-0025.2	G1020025	571387J-AS	B1.G102-0308.2	G1020308
562229J	B1.G212-0157.1	G2112157	571315J-AS	B1.G102-0025.2	G1020025	571388J	B1.G102-0339.2	G1020339
562234J	B1.G230-0114.1	G2130114	571316D	B1.G102-0010.2	G1020010	571389J	B1.G102-0271.2	G1020271
562235J	B1.G225-0145.1	G2125145	571316J	B1.G102-0010.2	G1020010	571391D	B1.G102-0258.2	G1020258
562236J	B1.G210-0277.1	G2110277	571316J-AS	B1.G102-0010.2	G1020010	571391J	B1.G102-0258.2	G1020258
562237J	B1.G222-0210.1	G2122210	571317D	B1.G102-0009.2	G1020009	571391J-AS	B1.G102-0258.2	G1020258
562238J	B1.G212-0158.1	G2112158	571317J	B1.G102-0009.2	G1020009	571395J-AS	B1.G102-0291.2	G1020291
562239J	B1.G230-0115.1	G2130115	571317J-AS	B1.G102-0009.2	G1020009	571398J	B1.G102-0373.2	G1020373
562240J	B1.G225-0142.1	G2125142	571319D	B1.G102-0299.2	G1020299	571406D	B1.G102-0299.2	G1020299
562241J	B1.G228-0132.1	G2128132	571319J	B1.G102-0299.2	G1020299	571406J	B1.G102-0299.2	G1020299
562243J	B1.G228-0142.1	G2128142	571320D	B1.G102-0213.2	G1020213	571407D	B1.G102-0272.2	G1020272
562253J	B1.G212-0162.1	G2112162	571320J	B1.G102-0213.2	G1020213	571407J	B1.G102-0272.2	G1020272
562258J	B1.G212-0169.1	G2112169	571327J-AS	B1.G102-0501.2	G1020501	571409J	B1.G102-0236.2	G1020236
562261J	B1.G209-0139.1	G2109139	571330D	B1.G102-0184.2	G1020184	571411J	B1.G102-0608.2	G1020608
562262J	B1.G222-0211.1	G2122211	571330J	B1.G102-0184.2	G1020184	571412J	B1.G102-0332.2	G1020332
562264J	B1.G210-0285.1	G2110285	571331D	B1.G102-0219.2	G1020219	571418J	B1.G102-0955.2	G1020955
562265J	B1.G230-0175.1	G2130175	571331D	B1.G102-0323.2	G1020323	571425D	B1.G102-0327.2	G1020327
562268J	B1.G222-0216.1	G2122216	571331J	B1.G102-0219.2	G1020219	571425J	B1.G102-0327.2	G1020327

# Cross reference list

Liste des correspondances / Tabella di conversione codici / Lista de comparação /



Lista porównawcza numerów / Porovnávací seznam čísel

JURID		JURID		JURID	
571425J-AS	B1.G102-0327.2 G1020327	571744J	B1.G102-0522.2 G1020522	571882J	B1.G102-0340.2 G1020340
571435J	B1.G102-0339.2 G1020339	571745D	B1.G102-0617.2 G1020617	571883J	B1.G102-0342.2 G1020342
571457J	B1.G102-0956.2 G1020956	571745J	B1.G102-0617.2 G1020617	571884J	B1.G102-0360.2 G1020360
571458J	B1.G102-0315.2 G1020315	571746D	B1.G102-0618.2 G1020618	571887J	B1.G102-0340.2 G1020340
571460J	B1.G102-0304.2 G1020304	571746J	B1.G102-0618.2 G1020618	571893J	B1.G102-0298.2 G1020298
571462J	B1.G102-0246.2 G1020246	571747D	B1.G102-0777.2 G1020777	571897D	B1.G102-0362.2 G1020362
571464J	B1.G102-0141.2 G1020141	571747J	B1.G102-0777.2 G1020777	571897J	B1.G102-0362.2 G1020362
571473D	B1.G102-0275.2 G1020275	571747J-AS	B1.G102-0777.2 G1020777	571898D	B1.G102-0363.2 G1020363
571473J	B1.G102-0275.2 G1020275	571749D	B1.G102-0259.2 G1020259	571898J	B1.G102-0363.2 G1020363
571473J-AS	B1.G102-0275.2 G1020275	571749J	B1.G102-0259.2 G1020259	571899D	B1.G102-0373.2 G1020373
571476D	B1.G102-0326.2 G1020326	571754J	B1.G102-0885.2 G1020885	571899J	B1.G102-0487.2 G1020487
571476J	B1.G102-0326.2 G1020326	571755J	B1.G102-0886.2 G1020886	571900J	B1.G102-0312.2 G1020312
571492D	B1.G102-0317.2 G1020317	571757J	B1.G102-0328.2 G1020328	571902J	B1.G102-0293.2 G1020293
571492J	B1.G102-0317.2 G1020317	571828D	B1.G102-0337.2 G1020337	571902J-AS	B1.G102-0293.2 G1020293
571492J-AS	B1.G102-0317.2 G1020317	571828J	B1.G102-0337.2 G1020337	571906D	B1.G102-0345.2 G1020345
571509D	B1.G102-0292.2 G1020292	571828J-AS	B1.G102-0337.2 G1020337	571906D	B1.G102-0549.2 G1020549
571509J	B1.G102-0292.2 G1020292	571832D	B1.G102-0320.2 G1020320	571906J	B1.G102-0345.2 G1020345
571509J-AS	B1.G102-0292.2 G1020292	571832J	B1.G102-0320.2 G1020320	571906J	B1.G102-0549.2 G1020549
571512J	B1.G102-0311.2 G1020311	571833D	B1.G102-0015.2 G1020015	571908J	B1.G102-0359.2 G1020359
571522D	B1.G102-0265.2 G1020265	571833J	B1.G102-0015.2 G1020015	571910J	B1.G102-0397.2 G1020397
571522J	B1.G102-0265.2 G1020265	571833J-AS	B1.G102-0015.2 G1020015	571910J-AS	B1.G102-0397.2 G1020397
571523D	B1.G102-0298.2 G1020298	571837J	B1.G102-0291.2 G1020291	571911D	B1.G102-0215.2 G1020215
571523J	B1.G102-0298.2 G1020298	571838J	B1.G102-0310.2 G1020310	571911J	B1.G102-0215.2 G1020215
571524D	B1.G102-0296.2 G1020296	571838J-AS	B1.G102-0310.2 G1020310	571912J	B1.G102-0443.2 G1020443
571524J	B1.G102-0296.2 G1020296	571839D	B1.G102-0301.2 G1020301	571912J-AS	B1.G102-0443.2 G1020443
571525D	B1.G102-0295.2 G1020295	571839J	B1.G102-0301.2 G1020301	571913J	B1.G102-0332.2 G1020333
571525J	B1.G102-0295.2 G1020295	571840D	B1.G102-0302.2 G1020302	571914J	B1.G102-0334.2 G1020334
571525J-AS	B1.G102-0295.2 G1020295	571840J	B1.G102-0302.2 G1020302	571915D	B1.G102-0355.2 G1020355
571526D	B1.G102-0501.2 G1020501	571843J	B1.G102-0350.2 G1020350	571915J	B1.G102-0355.2 G1020355
571526J	B1.G102-0501.2 G1020501	571844J	B1.G102-0742.2 G1020742	571916J	B1.G102-0427.2 G1020427
571527J	B1.G102-0316.2 G1020316	571844J-AS	B1.G102-0742.2 G1020742	571917J	B1.G102-0389.2 G1020389
571528D	B1.G102-0305.2 G1020305	571845J	B1.G102-0395.2 G1020395	571918J	B1.G102-0367.2 G1020367
571528J	B1.G102-0305.2 G1020305	571845J-AS	B1.G102-0395.2 G1020395	571918J-AS	B1.G102-0367.2 G1020367
571530J	B1.G102-0369.2 G1020369	571846J	B1.G102-0396.2 G1020396	571919D	B1.G102-0451.2 G1020451
571530J-AS	B1.G102-0369.2 G1020369	571846J-AS	B1.G102-0396.2 G1020396	571919J	B1.G102-0451.2 G1020451
571536D	B1.G102-0334.2 G1020334	571847D	B1.G102-0347.2 G1020347	571919J-AS	B1.G102-0451.2 G1020451
571536J	B1.G102-0334.2 G1020334	571847J	B1.G102-0347.2 G1020347	571920J	B1.G102-0403.2 G1020403
571539J	B1.G102-0015.2 G1020015	571847J-AS	B1.G102-0347.2 G1020347	571921J	B1.G102-0312.2 G1020312
571539J-AS	B1.G102-0015.2 G1020015	571848D	B1.G102-0344.2 G1020344	571922J	B1.G102-0459.2 G1020459
571545J-AS	B1.G102-0308.2 G1020308	571848J	B1.G102-0344.2 G1020344	571922J-AS	B1.G102-0459.2 G1020459
571546J	B1.G102-0308.2 G1020308	571850J	B1.G102-0290.2 G1020290	571923J	B1.G102-0408.2 G1020408
571546J-AS	B1.G102-0308.2 G1020308	571852J	B1.G102-0372.2 G1020372	571925J	B1.G102-0441.2 G1020441
571555J	B1.G102-0046.2 G1020046	571855J	B1.G102-0028.2 G1020028	571925J-AS	B1.G102-0441.2 G1020441
571555J-AS	B1.G102-0046.2 G1020046	571864J	B1.G102-0273.2 G1020273	571929J	B1.G102-0331.2 G1020331
571559J-AS	B1.G102-0257.2 G1020257	571868J	B1.G102-0257.2 G1020257	571930J	B1.G102-0497.2 G1020497
571560J	B1.G102-0044.2 G1020044	571872J-AS	B1.G102-0683.2 G1020683	571930J-AS	B1.G102-0497.2 G1020497
571560J-AS	B1.G102-0044.2 G1020044	571873J	B1.G102-0368.2 G1020368	571931J	B1.G102-0497.2 G1020497
571722J	B1.G102-0400.2 G1020400	571873J-AS	B1.G102-0368.2 G1020368	571931J-AS	B1.G102-0497.2 G1020497
571722J-AS	B1.G102-0400.2 G1020400	571875J	B1.G102-0529.2 G1020529	571933J	B1.G102-0392.2 G1020392
571725J	B1.G102-0423.2 G1020423	571875J	B1.G102-0658.2 G1020658	571933J	B1.G102-0500.2 G1020500
571725J-AS	B1.G102-0423.2 G1020423	571875J-AS	B1.G102-0658.2 G1020658	571934J	B1.G102-0419.2 G1020419
571726D	B1.G102-0423.2 G1020423	571876J	B1.G102-0401.2 G1020401	571934J	B1.G102-0534.2 G1020534
571726J	B1.G102-0423.2 G1020423	571876J-AS	B1.G102-0401.2 G1020401	571935J	B1.G102-0379.2 G1020379
571726J-AS	B1.G102-0423.2 G1020423	571877J	B1.G102-0398.2 G1020398	571936J	B1.G102-0415.2 G1020415
571743D	B1.G102-0295.2 G1020295	571877J-AS	B1.G102-0398.2 G1020398	571939D	B1.G102-0390.2 G1020390
571743J	B1.G102-0295.2 G1020295	571880J	B1.G102-0411.2 G1020411	571939J	B1.G102-0390.2 G1020390
571744J	B1.G102-0216.2 G1020216	571880J-AS	B1.G102-0411.2 G1020411	571940J	B1.G102-0457.2 G1020457

# Cross reference list



Liste des correspondances / Tabella di conversione codici / Lista de comparação /

Lista porównawcza numerów / Porovnávací seznam čísel

JURID 	JURID 	JURID 
571941J	B1.G102-0458.2 G1020458	571997J B1.G102-0642.2 G1020642
571944J	B1.G102-0440.2 G1020440	571998D B1.G102-0507.2 G1020507
571944J-AS	B1.G102-0440.2 G1020440	571998J B1.G102-0507.2 G1020507
571945J	B1.G102-0440.2 G1020440	572217J B1.G120-1056.2 G1201056
571945J	B1.G120-1272.2 G1201272	572245J B1.G120-5404.2 G1205404
571945J-AS	B1.G102-0440.2 G1020440	572340J B1.G102-0722.2 G1020722
571945J-AS	B1.G120-1272.2 G1201272	572405J B1.G102-0714.2 G1020714
571946J	B1.G102-0582.2 G1020582	572432J B1.G120-5344.2 G1205344
571947J	B1.G102-0584.2 G1020584	572473J B1.G120-1000.2 G1201000
571947J-AS	B1.G102-0584.2 G1020584	572482J B1.G102-0719.2 G1020719
571948J	B1.G102-0315.2 G1020315	572485J B1.G102-0662.2 G1020662
571949J	B1.G102-0351.2 G1020351	572491J B1.G102-0712.2 G1020712
571950J	B1.G102-0583.2 G1020583	572492J B1.G102-0713.2 G1020713
571950J-AS	B1.G102-0583.2 G1020583	572498J B1.G120-5230.2 G1205230
571951J	B1.G102-0360.2 G1020360	572515J B1.G120-5333.2 G1205333
571955J	B1.G102-0421.2 G1020421	572516J B1.G102-0663.2 G1020663
571959D	B1.G102-0608.2 G1020608	572526J B1.G120-1047.2 G1201047
571959J	B1.G102-0608.2 G1020608	572549J B1.G120-1025.2 G1201025
571959J-AS	B1.G102-0608.2 G1020608	572550J B1.G120-5418.2 G1205418
571960J	B1.G102-0316.2 G1020316	572584J B1.G120-1085.2 G1201085
571960J-AS	B1.G102-0316.2 G1020316	572623J B1.G120-1209.2 G1201209
571961J-AS	B1.G102-0574.2 G1020574	573002J B1.G102-0411.2 G1020411
571964J	B1.G102-0423.2 G1020423	573002J-AS B1.G102-0411.2 G1020411
571965J	B1.G102-0513.2 G1020513	573003J B1.G102-0578.2 G1020578
571966J	B1.G102-0570.2 G1020570	573003J-AS B1.G102-0578.2 G1020578
571967D	B1.G102-0505.2 G1020505	573005J B1.G102-0489.2 G1020489
571967J	B1.G102-0505.2 G1020505	573006J B1.G102-0511.2 G1020511
571968J	B1.G102-0542.2 G1020542	573008J B1.G102-0569.2 G1020569
571969J	B1.G102-0444.2 G1020444	573009J B1.G102-0560.2 G1020560
571971D	B1.G102-0463.2 G1020463	573010J B1.G102-0554.2 G1020554
571971J	B1.G102-0463.2 G1020463	573011J B1.G102-0545.2 G1020545
571972J	B1.G102-0469.2 G1020469	573012J B1.G102-0563.2 G1020563
571973J	B1.G102-0484.2 G1020484	573013J B1.G102-0562.2 G1020562
571974J	B1.G102-0448.2 G1020448	573014J B1.G102-0568.2 G1020568
571974J	B1.G102-0496.2 G1020496	573015J B1.G102-0597.2 G1020597
571975J	B1.G102-0550.2 G1020550	573016J B1.G102-0576.2 G1020576
571979D	B1.G102-0384.2 G1020384	573017J B1.G102-0547.2 G1020547
571979J	B1.G102-0384.2 G1020384	573018J B1.G102-0470.2 G1020470
571981J	B1.G102-0605.2 G1020605	573019J B1.G102-0567.2 G1020567
571981J-AS	B1.G102-0605.2 G1020605	573020J B1.G102-0562.2 G1020562
571982D	B1.G102-0313.2 G1020313	573021J B1.G102-0480.2 G1020480
571982J	B1.G102-0313.2 G1020313	573022J B1.G102-0557.2 G1020557
571984J	B1.G102-0512.2 G1020512	573025J B1.G102-0548.2 G1020548
571985J	B1.G102-0331.2 G1020331	573027J B1.G102-0602.2 G1020602
571987J	B1.G102-0924.2 G1020924	573028J B1.G102-0604.2 G1020604
571987J-AS	B1.G102-0924.2 G1020924	573029J B1.G102-0603.2 G1020603
571988J	B1.G102-0442.2 G1020442	573031J B1.G102-0735.2 G1020735
571988J-AS	B1.G102-0442.2 G1020442	573032J B1.G102-0492.2 G1020492
571989J-AS	B1.G102-0652.2 G1020652	573033J B1.G120-5215.2 G1205215
571990J-AS	B1.G102-0634.2 G1020634	573036J-AS B1.G102-0513.2 G1020513
571991J-AS	B1.G102-0638.2 G1020638	573037J B1.G102-0313.2 G1020313
571992J	B1.G102-0646.2 G1020646	573038J B1.G102-0654.2 G1020654
571992J-AS	B1.G102-0646.2 G1020646	573039J B1.G102-0537.2 G1020537
571994J-AS	B1.G102-0591.2 G1020591	573041J B1.G102-0519.2 G1020519
571995J	B1.G102-0540.2 G1020540	573042J B1.G102-0473.2 G1020473
571996D	B1.G102-0467.2 G1020467	573045J B1.G102-0527.2 G1020527
571996J	B1.G102-0467.2 G1020467	573046J B1.G102-0533.2 G1020533
		573046J-AS B1.G102-0533.2 G1020533
		573047J B1.G102-0580.2 G1020580
		573047J-AS B1.G102-0580.2 G1020580
		573048J B1.G102-0529.2 G1020529
		573049J B1.G102-0654.2 G1020654
		573050J B1.G102-0524.2 G1020524
		573052J B1.G102-0956.2 G1020956
		573053J B1.G102-0422.2 G1020422
		573055J B1.G102-0627.2 G1020627
		573056J B1.G102-0648.2 G1020648
		573058J B1.G102-0633.2 G1020633
		573058J-AS B1.G102-0633.2 G1020633
		573059J B1.G102-0529.2 G1020529
		573060J B1.G102-0482.2 G1020482
		573061J B1.G102-0483.2 G1020483
		573065J B1.G102-0564.2 G1020564
		573074D B1.G102-0740.2 G1020740
		573074D B1.G120-1224.2 G1201224
		573074J B1.G102-0740.2 G1020740
		573074J B1.G120-1224.2 G1201224
		573075D B1.G102-0503.2 G1020503
		573075D B1.G120-1225.2 G1201225
		573075J B1.G102-0503.2 G1020503
		573075J B1.G120-1225.2 G1201225
		573076D B1.G102-0504.2 G1020504
		573076J B1.G102-0504.2 G1020504
		573082J B1.G102-0544.2 G1020544
		573083J B1.G102-0686.2 G1020686
		573084J B1.G102-0687.2 G1020687
		573085J B1.G102-0692.2 G1020692
		573089D B1.G102-0650.2 G1020650
		573089J B1.G102-0650.2 G1020650
		573090J B1.G102-0756.2 G1020756
		573091J B1.G102-0632.2 G1020632
		573092J B1.G102-0677.2 G1020677
		573092J-AS B1.G102-0677.2 G1020677
		573093J-AS B1.G102-0441.2 G1020441
		573095J-AS B1.G102-0459.2 G1020459
		573096J B1.G102-0514.2 G1020514
		573100J B1.G102-0615.2 G1020615
		573101J B1.G102-0732.2 G1020732
		573105J B1.G102-0515.2 G1020515
		573106J B1.G102-0534.2 G1020534
		573107J B1.G102-0624.2 G1020624
		573109J B1.G102-0427.2 G1020427
		573110D B1.G102-0595.2 G1020595
		573110J B1.G102-0595.2 G1020595
		573111J B1.G102-0409.2 G1020409
		573112J B1.G102-0566.2 G1020566
		573113J B1.G102-0516.2 G1020516
		573114J B1.G102-0517.2 G1020517
		573115D B1.G102-0518.2 G1020518
		573115J B1.G102-0518.2 G1020518
		573120J B1.G102-0563.2 G1020563
		573122J B1.G102-0610.2 G1020610
		573124J B1.G102-0685.2 G1020685
		573125J B1.G102-0538.2 G1020538

# Cross reference list



Liste des correspondances / Tabella di conversione codici / Lista de comparação /  
 Lista porównawcza numerów / Porovnávací seznam čísel

JURID 	JURID 	LAND ROVER 
573125J	B1.G102-0741.2 G1020741	573270J B1.G120-1145.2 G1201145
573127J	B1.G102-0733.2 G1020733	573274J B1.G102-0730.2 G1020730
573128J-AS	B1.G102-0680.2 G1020680	573275J B1.G102-0801.2 G1020801
573130J	B1.G102-0496.2 G1020496	573276J B1.G102-0800.2 G1020800
573131J-AS	B1.G102-0762.2 G1020762	573277J B1.G102-0802.2 G1020802
573132J-AS	B1.G102-0761.2 G1020761	573288J B1.G102-0774.2 G1020774
573133J-AS	B1.G102-0660.2 G1020660	573329J B1.G120-1079.2 G1201079
573134J-AS	B1.G102-0745.2 G1020745	573359J B1.G102-0907.2 G1020907
573135J-AS	B1.G102-0830.2 G1020830	82 900 24 320 B1.G220-0123.1 G2120123
573136J-AS	B1.G102-0844.2 G1020844	82 900 73 320 B1.G212-0106.1 G2112106
573137J-AS	B1.G102-0794.2 G1020794	82 901 70 320 B1.G213-0161.1 G2113161
573138J-AS	B1.G102-0846.2 G1020846	82 902 17 320 B1.G210-0178.1 G2110178
573139J	B1.G102-0850.2 G1020850	82 902 38 320 B1.G220-0115.1 G2120115
573139J-AS	B1.G102-0850.2 G1020850	82 902 40 320 B1.G210-0187.1 G2110187
573142J-AS	B1.G102-0694.2 G1020694	82 902 76 320 B1.G209-0120.1 G2109120
573143J-AS	B1.G102-0696.2 G1020696	82 902 79 320 B1.G212-0116.1 G2112116
573144J	B1.G102-0573.2 G1020573	82 903 21 320 B1.G208-0104.1 G2108104
573145J	B1.G102-0644.2 G1020644	82 903 44 320 B1.G220-0125.1 G2120125
573146J	B1.G102-0642.2 G1020642	82 903 51 320 B1.G220-0128.1 G2120128
573147J	B1.G102-0575.2 G1020575	82 903 52 320 B1.G210-0111.1 G2110111
573150J-AS	B1.G102-0746.2 G1020746	82 903 64 320 B1.G210-0190.1 G2110190
573151J	B1.G102-0586.2 G1020586	82 904 87 320 B1.G220-0132.1 G2120132
573151J	B1.G102-0848.2 G1020848	82 904 90 320 B1.G210-0115.1 G2110115
573152J-AS	B1.G102-0677.2 G1020677	82 905 03 320 B1.G224-0115.1 G2124115
573153J	B1.G102-0765.2 G1020765	82 905 05 320 B1.G213-0178.1 G2113178
573158J	B1.G102-0682.2 G1020682	82 905 23 320 B1.G212-0127.1 G2112127
573158J	B1.G102-0734.2 G1020734	82 905 99 320 B1.G210-0196.1 G2110196
573159J-AS	B1.G102-0707.2 G1020707	82 906 00 320 B1.G220-0147.1 G2120147
573160J-AS	B1.G102-0706.2 G1020706	82 964 00 320 B1.G210-0151.1 G2110151
573161J-AS	B1.G102-0591.2 G1020591	
573164J	B1.G102-0737.2 G1020737	<b>KIA</b>
573165J	B1.G102-0738.2 G1020738	0K2JA-33-28Z B1.G120-1002.2 G1201002
573169J	B1.G102-0621.2 G1020621	0K2JA-33-28ZA B1.G120-1002.2 G1201002
573171J	B1.G102-0614.2 G1020614	51712-07500 B1.G218-0145.1 G2118145
573172J	B1.G102-0740.2 G1020740	51712-1H000 B1.G226-0150.1 G2126150
573173J	B1.G102-0701.2 G1020701	51712-1H100 B1.G226-0150.1 G2126150
573175J-AS	B1.G102-0860.2 G1020860	51712-2K100 B1.G226-0150.1 G2126150
573177J-AS	B1.G102-0659.2 G1020659	58101-07A00 B1.G120-1047.2 G1201047
573178J-AS	B1.G102-0877.2 G1020877	58101-07A10 B1.G120-1047.2 G1201047
573179J-AS	B1.G120-1009.2 G1201009	58101-07A20 B1.G120-1047.2 G1201047
573181J-AS	B1.G102-0939.2 G1020939	58101-1GE00 B1.G120-1033.2 G1201033
573184J-AS	B1.G102-0735.2 G1020735	58101-1HA00 B1.G120-1002.2 G1201002
573188J-AS	B1.G102-0848.2 G1020848	58101-1HA10 B1.G120-1002.2 G1201002
573189J-AS	B1.G102-0634.2 G1020634	58101-1HA20 B1.G120-1002.2 G1201002
573192J	B1.G102-0790.2 G1020790	58302-1GA00 B1.G120-1035.2 G1201035
573193J	B1.G102-0792.2 G1020792	58302-1HA00 B1.G120-1035.2 G1201035
573194J	B1.G102-0799.2 G1020799	58302-1PA30 B1.G102-0610.2 G1020610
573206J	B1.G102-0593.2 G1020593	58302-2SA30 B1.G120-1035.2 G1201035
573214J	B1.G102-0886.2 G1020886	58302-2YA30 B1.G120-1035.2 G1201035
573219J	B1.G102-0758.2 G1020758	58302-3ED00 B1.G120-1025.2 G1201025
573219J	B1.G102-0759.2 G1020759	58302-3ED01 B1.G120-1025.2 G1201025
573220J	B1.G102-0699.2 G1020699	58302-3EE00 B1.G120-1025.2 G1201025
573235J	B1.G102-0995.2 G1020995	58411-07300 B1.G210-0324.1 G2110324
573257J	B1.G102-0933.2 G1020933	58411-07500 B1.G210-0324.1 G2110324
573260J	B1.G102-0763.2 G1020763	
573260J	B1.G102-0872.2 G1020872	
573269J	B1.G120-1143.2 G1201143	
		<b>LEXUS</b>
		04465-12610 B1.G120-1065.2 G1201065
		04465-35290 B1.G120-5333.2 G1205333
		04465-60320 B1.G120-5333.2 G1205333
		04466-33180 B1.G120-1022.2 G1201022
		04466-47030 B1.G102-0975.2 G1020975
		04466-60080 B1.G120-5404.2 G1205404
		04466-60090 B1.G120-5404.2 G1205404
		04466-60140 B1.G120-5404.2 G1205404
		<b>LUCAS (TRW)</b>
		32 932 518 B1.G102-0334.2 G1020334
		32 932 565 B1.G102-0197.2 G1020197
		32 932 656 B1.G102-0097.2 G1020097
		32 932 749 B1.G102-0022.2 G1020022
		32 932 787 B1.G102-0009.2 G1020009
		32 932 840 B1.G102-0044.2 G1020044
		32 932 843 B1.G102-0214.2 G1020214
		32 932 848 B1.G102-0025.2 G1020025
		32 932 886 B1.G102-0015.2 G1020015
		32 932 887 B1.G102-0213.2 G1020213
		32 932 942 B1.G102-0257.2 G1020257
		32 932 957 B1.G102-0026.2 G1020026
		32 932 958 B1.G102-0046.2 G1020046
		32 932 991 B1.G102-0269.2 G1020269
		32 934 009 B1.G102-0201.2 G1020201
		32 934 026 B1.G102-0271.2 G1020271
		32 934 065 B1.G102-0474.2 G1020474
		32 934 066 B1.G102-0308.2 G1020308
		32 934 097 B1.G102-0184.2 G1020184
		32 934 100 B1.G102-0258.2 G1020258
		32 934 101 B1.G102-0272.2 G1020272
		32 934 112 B1.G102-0339.2 G1020339
		32 934 178 B1.G102-0236.2 G1020236
		32 934 184 B1.G102-0304.2 G1020304
		32 934 190 B1.G102-0274.2 G1020274
		32 934 191 B1.G102-0273.2 G1020273
		32 934 199 B1.G102-0010.2 G1020010
		32 934 239 B1.G102-0315.2 G1020315
		32 934 302 B1.G102-0329.2 G1020329
		32 934 412 B1.G102-0317.2 G1020317
		32 934 425 B1.G102-0311.2 G1020311
		67 933 009 B1.G102-0147.2 G1020147
		67 933 930 B1.G102-0028.2 G1020028
		DF1013 B1.G212-0116.1 G2112116
		DF1013BP B1.G212-0116.1 G2112116

# Cross reference list

Liste des correspondances / Tabella di conversione codici / Lista de comparação /



Lista porównawcza numerów / Porovnávací seznam čísel

LUCAS (TRW)			LUCAS (TRW)			LUCAS (TRW)		
								
DF1015	B1.G208-0104.1	G2108104	DF2592	B1.G210-0215.1	G2110215	DF2786	B1.G224-0131.1	G2124131
DF1015BP	B1.G208-0104.1	G2108104	DF2611	B1.G212-0137.1	G2112137	DF2786BP	B1.G224-0131.1	G2124131
DF1016	B1.G220-0125.1	G2120125	DF2622	B1.G224-0120.1	G2124120	DF2790	B1.G222-0161.1	G2122161
DF1016BP	B1.G220-0125.1	G2120125	DF2622BP	B1.G224-0120.1	G2124120	DF2796	B1.G226-0106.1	G2126106
DF1032	B1.G222-0148.1	G2122148	DF2623	B1.G220-0146.1	G2120146	DF2796BP	B1.G226-0106.1	G2126106
DF1032BP	B1.G222-0148.1	G2122148	DF2646	B1.G210-0212.1	G2110212	DF2803	B1.G222-0151.1	G2122151
DF1033	B1.G224-0171.1	G2124171	DF2647	B1.G210-0213.1	G2110213	DF2803BP	B1.G222-0151.1	G2122151
DF1120	B1.G208-0107.1	G2108107	DF2650	B1.G215-0105.1	G2115105	DF2804	B1.G222-0150.1	G2122150
DF1120BP	B1.G208-0107.1	G2108107	DF2651	B1.G210-0201.1	G2110201	DF2804BP	B1.G222-0150.1	G2122150
DF1217	B1.G210-0187.1	G2110187	DF2652	B1.G225-0105.1	G2125105	DF2805	B1.G209-0123.1	G2109123
DF1220	B1.G220-0133.1	G2120133	DF2652BP	B1.G225-0105.1	G2125105	DF2805BP	B1.G209-0123.1	G2109123
DF1220BP	B1.G220-0133.1	G2120133	DF2653	B1.G209-0120.1	G2109120	DF2806	B1.G222-0152.1	G2122152
DF1221	B1.G220-0132.1	G2120132	DF2653BP	B1.G209-0120.1	G2109120	DF2806BP	B1.G222-0152.1	G2122152
DF1221BP	B1.G220-0132.1	G2120132	DF2655	B1.G210-0261.1	G2110261	DF2808	B1.G213-0184.1	G2113184
DF1440	B1.G210-0212.1	G2110212	DF2655BP	B1.G210-0261.1	G2110261	DF2813	B1.G210-0217.1	G2110217
DF1516	B1.G212-0106.1	G2112106	DF2683	B1.G225-0124.1	G2125124	DF2815	B1.G213-0185.1	G2113185
DF1517	B1.G220-0123.1	G2120123	DF2686	B1.G220-0142.1	G2120142	DF2815BP	B1.G213-0185.1	G2113185
DF1517BP	B1.G220-0123.1	G2120123	DF2706	B1.G208-0108.1	G2108108	DF3021	B1.G221-0105.1	G2121105
DF1518	B1.G210-0151.1	G2110151	DF2708	B1.G208-0109.1	G2108109	DF4027	B1.G225-0113.1	G2125113
DF1526	B1.G210-0178.1	G2110178	DF2708S	B1.G208-0109.1	G2108109	DF4034	B1.G212-0144.1	G2112144
DF1529	B1.G210-0111.1	G2110111	DF2709	B1.G208-0108.1	G2108108	DF4036	B1.G222-0172.1	G2122172
DF1529BP	B1.G210-0111.1	G2110111	DF2709S	B1.G208-0108.1	G2108108	DF4036BP	B1.G222-0172.1	G2122172
DF1532	B1.G213-0178.1	G2113178	DF2714	B1.G212-0131.1	G2112131	DF4038	B1.G210-0258.1	G2110258
DF1532BP	B1.G213-0178.1	G2113178	DF2721	B1.G224-0127.1	G2124127	DF4042	B1.G224-0152.1	G2124152
DF1533	B1.G220-0128.1	G2120128	DF2722	B1.G224-0138.1	G2124138	DF4042BP	B1.G224-0152.1	G2124152
DF1533BP	B1.G220-0128.1	G2120128	DF2729	B1.G208-0109.1	G2108109	DF4045	B1.G225-0115.1	G2125115
DF1537	B1.G212-0126.1	G2112126	DF2729S	B1.G208-0109.1	G2108109	DF4047	B1.G212-0138.1	G2112138
DF1537BP	B1.G212-0126.1	G2112126	DF2730	B1.G213-0181.1	G2113181	DF4048	B1.G225-0131.1	G2125131
DF1538	B1.G222-0115.1	G2122115	DF2734	B1.G222-0197.1	G2122197	DF4050	B1.G210-0251.1	G2110251
DF1539	B1.G210-0202.1	G2110202	DF2752	B1.G212-0141.1	G2112141	DF4051	B1.G210-0250.1	G2110250
DF1583	B1.G209-0120.1	G2109120	DF2752BP	B1.G212-0141.1	G2112141	DF4051BP	B1.G210-0250.1	G2110250
DF1583BP	B1.G209-0120.1	G2109120	DF2753	B1.G220-0147.1	G2120147	DF4052	B1.G209-0133.1	G2109133
DF1608	B1.G213-0161.1	G2113161	DF2753BP	B1.G220-0147.1	G2120147	DF4052BP	B1.G209-0133.1	G2109133
DF1608BP	B1.G213-0161.1	G2113161	DF2754	B1.G220-0155.1	G2120155	DF4055	B1.G222-0160.1	G2122160
DF1609	B1.G220-0115.1	G2120115	DF2754BP	B1.G220-0155.1	G2120155	DF4062	B1.G209-0124.1	G2109124
DF1609BP	B1.G220-0115.1	G2120115	DF2755	B1.G210-0232.1	G2110232	DF4064	B1.G225-0123.1	G2125123
DF1622	B1.G224-0131.1	G2124131	DF2755BP	B1.G210-0232.1	G2110232	DF4065	B1.G222-0163.1	G2122163
DF1622BP	B1.G224-0131.1	G2124131	DF2757	B1.G209-0114.1	G2109114	DF4069	B1.G219-0108.1	G2119108
DF1624	B1.G220-0140.1	G2120140	DF2765	B1.G213-0182.1	G2113182	DF4082	B1.G210-0229.1	G2110229
DF1624BP	B1.G220-0140.1	G2120140	DF2765BP	B1.G213-0182.1	G2113182	DF4109	B1.G224-0171.1	G2124171
DF1625	B1.G224-0115.1	G2124115	DF2767	B1.G219-0107.1	G2119107	DF4110	B1.G224-0158.1	G2124158
DF1625BP	B1.G224-0115.1	G2124115	DF2769	B1.G222-0159.1	G2122159	DF4112	B1.G218-0131.1	G2118131
DF1654	B1.G210-0115.1	G2110115	DF2771	B1.G210-0210.1	G2110210	DF4123	B1.G213-0195.1	G2113195
DF1658	B1.G210-0196.1	G2110196	DF2772	B1.G210-0225.1	G2110225	DF4135	B1.G209-0136.1	G2109136
DF1658BP	B1.G210-0196.1	G2110196	DF2772BP	B1.G210-0225.1	G2110225	DF4147	B1.G224-0161.1	G2124161
DF1659	B1.G220-0147.1	G2120147	DF2776	B1.G225-0114.1	G2125114	DF4147BP	B1.G224-0161.1	G2124161
DF1738	B1.G222-0145.1	G2122145	DF2776BP	B1.G225-0114.1	G2125114	DF4148S	B1.G232-0115.1	G2132115
DF1739	B1.G210-0190.1	G2110190	DF2777	B1.G210-0223.1	G2110223	DF4149	B1.G228-0125.1	G2128125
DF1739BP	B1.G210-0209.1	G2110209	DF2778	B1.G225-0119.1	G2125119	DF4149S	B1.G228-0125.1	G2128125
DF1746	B1.G220-0142.1	G2120142	DF2778BPS	B1.G225-0119.1	G2125119	DF4163	B1.G220-0175.1	G2120175
DF1747	B1.G212-0127.1	G2112127	DF2778S	B1.G225-0119.1	G2125119	DF4164	B1.G224-0171.1	G2124171
DF1747BP	B1.G212-0127.1	G2112127	DF2779	B1.G225-0110.1	G2125110	DF4165	B1.G224-0166.1	G2124166
DF1749	B1.G222-0145.1	G2122145	DF2780	B1.G218-0106.1	G2118106	DF4165BP	B1.G224-0166.1	G2124166
DF1790	B1.G210-0190.1	G2110190	DF2780BP	B1.G218-0106.1	G2118106	DF4166	B1.G225-0138.1	G2125138
DF2566	B1.G222-0147.1	G2122147	DF2781	B1.G210-0230.1	G2110230	DF4166BP	B1.G225-0138.1	G2125138
DF2581	B1.G208-0106.1	G2108106	DF2784	B1.G210-0229.1	G2110229	DF4179	B1.G224-0169.1	G2124169
DF2586	B1.G221-0106.1	G2121106	DF2784BP	B1.G210-0229.1	G2110229	DF4180	B1.G225-0110.1	G2125110

# Cross reference list

Liste des correspondances / Tabella di conversione codici / Lista de comparação /

Lista porównawcza numerów / Porovnávací seznam čísel



LUCAS (TRW)		LUCAS (TRW)		LUCAS (TRW)				
DF4183	B1.G226-0120.1	G2126120	DF4321	B1.G222-0161.1	G2122161	DF4866S	B1.G225-0184.1	G2125184
DF4183BP	B1.G226-0120.1	G2126120	DF4335	B1.G209-0139.1	G2109139	DF7143	B1.G225-0155.1	G2125155
DF4184	B1.G222-0194.1	G2122194	DF4350S	B1.G230-0115.1	G2130115	DF7304	B1.G228-0177.1	G2128177
DF4184BP	B1.G222-0194.1	G2122194	DF4351	B1.G212-0162.1	G2112162	DF7318	B1.G222-0159.1	G2122159
DF4185	B1.G209-0137.1	G2109137	DF4357	B1.G210-0285.1	G2110285	DF7351	B1.G232-0144.1	G2132144
DF4185X	B1.G225-0137.1	G2125137	DF4358	B1.G230-0175.1	G2130175	GDB1030	B1.G102-0326.2	G1020326
DF4186	B1.G210-0261.1	G2110261	DF4358S	B1.G230-0175.1	G2130175	GDB1031	B1.G102-0275.2	G1020275
DF4186BP	B1.G210-0261.1	G2110261	DF4364	B1.G222-0216.1	G2122216	GDB1032	B1.G102-0296.2	G1020296
DF4197	B1.G222-0204.1	G2122204	DF4367	B1.G225-0155.1	G2125155	GDB1033	B1.G102-0295.2	G1020295
DF4198	B1.G210-0271.1	G2110271	DF4371	B1.G224-0191.1	G2124191	GDB1040	B1.G102-0317.2	G1020317
DF4206	B1.G225-0123.1	G2125123	DF4372	B1.G211-0155.1	G2111155	GDB1041	B1.G102-0327.2	G1020327
DF4209	B1.G230-0113.1	G2130113	DF4375	B1.G220-0184.1	G2120184	GDB1044	B1.G102-0274.2	G1020274
DF4209S	B1.G230-0113.1	G2130113	DF4381	B1.G212-0171.1	G2112171	GDB1048	B1.G102-0273.2	G1020273
DF4213	B1.G210-0211.1	G2110211	DF4382	B1.G212-0116.1	G2112116	GDB1049	B1.G102-0311.2	G1020311
DF4213BP	B1.G210-0211.1	G2110211	DF4384	B1.G225-0165.1	G2125165	GDB1050	B1.G102-0246.2	G1020246
DF4218	B1.G212-0154.1	G2112154	DF4385	B1.G225-0170.1	G2125170	GDB1055	B1.G102-0345.2	G1020345
DF4218BP	B1.G212-0154.1	G2112154	DF4393	B1.G222-0232.1	G2122232	GDB1078	B1.G102-0214.2	G1020214
DF4222	B1.G232-0114.1	G2132114	DF4403	B1.G225-0155.1	G2125155	GDB1079	B1.G102-0219.2	G1020219
DF4222BPS	B1.G232-0114.1	G2132114	DF4407	B1.G211-0154.1	G2111154	GDB1080	B1.G102-0618.2	G1020618
DF4222S	B1.G232-0114.1	G2132114	DF4419	B1.G211-0164.1	G2111164	GDB1084	B1.G102-0617.2	G1020617
DF4225	B1.G211-0152.1	G2111152	DF4422	B1.G211-0158.1	G2111158	GDB1092	B1.G102-0347.2	G1020347
DF4225BP	B1.G211-0152.1	G2111152	DF4424	B1.G225-0162.1	G2125162	GDB1094	B1.G102-0337.2	G1020337
DF4234	B1.G212-0155.1	G2112155	DF4425	B1.G211-0158.1	G2111158	GDB1099	B1.G102-0259.2	G1020259
DF4234BP	B1.G212-0155.1	G2112155	DF4426	B1.G225-0148.1	G2125148	GDB1100	B1.G102-0608.2	G1020608
DF4235	B1.G222-0151.1	G2122151	DF4426	B1.G225-0198.1	G2125198	GDB1101	B1.G102-0328.2	G1020328
DF4236	B1.G220-0174.1	G2120174	DF4439	B1.G220-0115.1	G2120115	GDB1104	B1.G102-0292.2	G1020292
DF4236BP	B1.G220-0174.1	G2120174	DF4442	B1.G210-0302.1	G2110302	GDB1105	B1.G102-0301.2	G1020301
DF4246	B1.G225-0142.1	G2125142	DF4449	B1.G222-0238.1	G2122238	GDB1106	B1.G102-0302.2	G1020302
DF4246BP	B1.G225-0142.1	G2125142	DF4449BP	B1.G222-0238.1	G2122238	GDB1107	B1.G102-0320.2	G1020320
DF4253	B1.G218-0137.1	G2118137	DF4450	B1.G220-0195.1	G2120195	GDB1108	B1.G102-0265.2	G1020265
DF4253BP	B1.G218-0137.1	G2118137	DF4450BP	B1.G220-0195.1	G2120195	GDB1109	B1.G102-0291.2	G1020291
DF4255	B1.G224-0158.1	G2124158	DF4453	B1.G208-0113.1	G2108113	GDB1112	B1.G102-0886.2	G1020886
DF4258S	B1.G230-0113.1	G2130113	DF4453BP	B1.G208-0113.1	G2108113	GDB1115	B1.G102-0298.2	G1020298
DF4261	B1.G228-0176.1	G2128176	DF4458	B1.G218-0145.1	G2118145	GDB1115	B1.G102-0621.2	G1020621
DF4261BP	B1.G228-0176.1	G2128176	DF4458BP	B1.G218-0145.1	G2118145	GDB1118	B1.G102-0368.2	G1020368
DF4262	B1.G225-0137.1	G2125137	DF4459	B1.G224-0197.1	G2124197	GDB1119	B1.G102-0367.2	G1020367
DF4262BPS	B1.G225-0137.1	G2125137	DF4459BP	B1.G224-0197.1	G2124197	GDB1121	B1.G102-0201.2	G1020201
DF4262S	B1.G225-0137.1	G2125137	DF4464	B1.G225-0158.1	G2125158	GDB1123	B1.G102-0400.2	G1020400
DF4263	B1.G210-0278.1	G2110278	DF4465	B1.G225-0117.1	G2125117	GDB1124	B1.G102-0290.2	G1020290
DF4264	B1.G232-0144.1	G2132144	DF4469	B1.G220-0180.1	G2120180	GDB1147	B1.G102-0359.2	G1020359
DF4266	B1.G212-0157.1	G2112157	DF4469BP	B1.G220-0180.1	G2120180	GDB1148	B1.G102-0310.2	G1020310
DF4267	B1.G222-0216.1	G2122216	DF4470	B1.G225-0149.1	G2125149	GDB1159	B1.G102-0956.2	G1020956
DF4268	B1.G234-0100.1	G2134100	DF4481	B1.G216-0124.1	G2116124	GDB1163	B1.G102-0246.2	G1020246
DF4268S	B1.G234-0100.1	G2134100	DF4497	B1.G225-0124.1	G2125124	GDB1166	B1.G102-0369.2	G1020369
DF4271	B1.G212-0158.1	G2112158	DF4549	B1.G228-0164.1	G2128164	GDB118	B1.G102-0065.2	G1020065
DF4275S	B1.G228-0132.1	G2128132	DF4558	B1.G212-0169.1	G2112169	GDB1182	B1.G120-5404.2	G1205404
DF4276	B1.G210-0277.1	G2110277	DF4692	B1.G222-0231.1	G2122231	GDB1183	B1.G102-0722.2	G1020722
DF4293	B1.G225-0141.1	G2125141	DF4695	B1.G230-0176.1	G2130176	GDB1189	B1.G102-0316.2	G1020316
DF4294	B1.G222-0210.1	G2122210	DF4742	B1.G207-0109.1	G2107109	GDB1192	B1.G102-0265.2	G1020265
DF4295	B1.G225-0145.1	G2125145	DF4750	B1.G216-0123.1	G2116123	GDB1193	B1.G102-0362.2	G1020362
DF4308BPS	B1.G230-0114.1	G2130114	DF4766	B1.G211-0145.1	G2111145	GDB1194	B1.G102-0363.2	G1020363
DF4308S	B1.G230-0114.1	G2130114	DF4770	B1.G216-0124.1	G2116124	GDB1196	B1.G102-0492.2	G1020492
DF4312	B1.G222-0211.1	G2122211	DF4786	B1.G226-0120.1	G2126120	GDB1196	B1.G102-0549.2	G1020549
DF4313	B1.G225-0162.1	G2125162	DF4796	B1.G222-0231.1	G2122231	GDB1198	B1.G102-0457.2	G1020457
DF4314	B1.G225-0117.1	G2125117	DF4801	B1.G210-0324.1	G2110324	GDB1200	B1.G102-0312.2	G1020312
DF4318	B1.G225-0148.1	G2125148	DF4822S	B1.G228-0203.1	G2128203	GDB1204	B1.G102-0312.2	G1020312
DF4318	B1.G225-0198.1	G2125198	DF4850S	B1.G228-0154.1	G2128154	GDB1205	B1.G102-0398.2	G1020398



# Cross reference list

Liste des correspondances / Tabella di conversione codici / Lista de comparação /



Lista porównawcza numerów / Porovnávací seznam čísel

LUCAS (TRW) 		LUCAS (TRW) 		LUCAS (TRW) 	
GDB1206	B1.G102-0658.2 G1020658	GDB1313	B1.G102-0537.2 G1020537	GDB1393	B1.G102-0427.2 G1020427
GDB1210	B1.G102-0340.2 G1020340	GDB1314	B1.G102-0458.2 G1020458	GDB1394	B1.G102-0882.2 G1020882
GDB1211	B1.G102-0342.2 G1020342	GDB1314	B1.G102-0780.2 G1020780	GDB1395	B1.G102-0883.2 G1020883
GDB1212	B1.G102-0473.2 G1020473	GDB1315	B1.G102-0359.2 G1020359	GDB1396	B1.G102-0568.2 G1020568
GDB1215	B1.G102-0401.2 G1020401	GDB1317	B1.G102-0457.2 G1020457	GDB1397	B1.G102-0463.2 G1020463
GDB1216	B1.G102-0350.2 G1020350	GDB1321	B1.G102-0497.2 G1020497	GDB1399	B1.G102-0583.2 G1020583
GDB1217	B1.G102-0216.2 G1020216	GDB1322	B1.G102-0293.2 G1020293	GDB1402	B1.G102-0497.2 G1020497
GDB1217	B1.G102-0522.2 G1020522	GDB1324	B1.G102-0658.2 G1020658	GDB1403	B1.G102-0512.2 G1020512
GDB1218	B1.G102-0355.2 G1020355	GDB1325	B1.G102-0658.2 G1020658	GDB1404	B1.G102-0411.2 G1020411
GDB1219	B1.G102-0344.2 G1020344	GDB1326	B1.G102-0654.2 G1020654	GDB1404	B1.G102-0591.2 G1020591
GDB1220	B1.G102-0742.2 G1020742	GDB1328	B1.G102-0345.2 G1020345	GDB1405	B1.G102-0569.2 G1020569
GDB1221	B1.G102-0332.2 G1020333	GDB1330	B1.G102-0492.2 G1020492	GDB1406	B1.G102-0956.2 G1020956
GDB1222	B1.G102-0334.2 G1020334	GDB1330	B1.G102-0549.2 G1020549	GDB1408	B1.G102-0584.2 G1020584
GDB1234	B1.G120-5203.2 G1205203	GDB1330	B1.G102-0755.2 G1020755	GDB1411	B1.G102-0545.2 G1020545
GDB1247	B1.G102-0329.2 G1020329	GDB1330	B1.G102-0920.2 G1020920	GDB1412	B1.G102-0560.2 G1020560
GDB1258	B1.G102-0316.2 G1020316	GDB1332	B1.G102-0501.2 G1020501	GDB1413	B1.G102-0924.2 G1020924
GDB1259	B1.G102-0363.2 G1020363	GDB1333	B1.G102-0384.2 G1020384	GDB1414	B1.G102-0732.2 G1020732
GDB1260	B1.G102-0451.2 G1020451	GDB1334	B1.G102-0442.2 G1020442	GDB1415	B1.G102-0564.2 G1020564
GDB1261	B1.G102-0368.2 G1020368	GDB1335	B1.G102-0441.2 G1020441	GDB1416	B1.G102-0492.2 G1020492
GDB1262	B1.G102-0396.2 G1020396	GDB1337	B1.G102-0500.2 G1020500	GDB1418	B1.G102-0467.2 G1020467
GDB1263	B1.G102-0397.2 G1020397	GDB1338	B1.G102-0392.2 G1020392	GDB1419	B1.G102-0519.2 G1020519
GDB1264	B1.G102-0411.2 G1020411	GDB1339	B1.G102-0351.2 G1020351	GDB1420	B1.G102-0605.2 G1020605
GDB1265	B1.G102-0415.2 G1020415	GDB1342	B1.G102-0642.2 G1020642	GDB1421	B1.G102-0442.2 G1020442
GDB1266	B1.G102-0421.2 G1020421	GDB1343	B1.G102-0316.2 G1020316	GDB1422	B1.G102-0463.2 G1020463
GDB1267	B1.G102-0492.2 G1020492	GDB1344	B1.G102-0316.2 G1020316	GDB1424	B1.G102-0597.2 G1020597
GDB1269	B1.G102-0372.2 G1020372	GDB1345	B1.G102-0357.2 G1020357	GDB1425	B1.G102-0482.2 G1020482
GDB1270	B1.G102-0459.2 G1020459	GDB1346	B1.G102-0271.2 G1020271	GDB1426	B1.G102-0483.2 G1020483
GDB1271	B1.G102-0403.2 G1020403	GDB1348	B1.G102-0608.2 G1020608	GDB1427	B1.G102-0360.2 G1020360
GDB1274	B1.G102-0408.2 G1020408	GDB1349	B1.G102-0423.2 G1020423	GDB1429	B1.G102-0956.2 G1020956
GDB1275	B1.G102-0379.2 G1020379	GDB1350	B1.G102-0550.2 G1020550	GDB1430	B1.G102-0316.2 G1020316
GDB1277	B1.G102-0215.2 G1020215	GDB1351	B1.G102-0542.2 G1020542	GDB1432	B1.G102-0487.2 G1020487
GDB1278	B1.G102-0293.2 G1020293	GDB1352	B1.G102-0554.2 G1020554	GDB1433	B1.G102-0544.2 G1020544
GDB1279	B1.G102-0443.2 G1020443	GDB1354	B1.G102-0507.2 G1020507	GDB1433	B1.G102-0852.2 G1020852
GDB1282	B1.G102-0419.2 G1020419	GDB1357	B1.G102-0331.2 G1020331	GDB1434	B1.G102-0562.2 G1020562
GDB1283	B1.G102-0422.2 G1020422	GDB1358	B1.G102-0505.2 G1020505	GDB1435	B1.G102-0563.2 G1020563
GDB1285	B1.G102-0683.2 G1020683	GDB1360	B1.G102-0489.2 G1020489	GDB1437	B1.G102-0444.2 G1020444
GDB1287	B1.G102-0331.2 G1020331	GDB1365	B1.G102-0540.2 G1020540	GDB1439	B1.G102-0559.2 G1020559
GDB1288	B1.G102-0891.2 G1020891	GDB1366	B1.G102-0511.2 G1020511	GDB1440	B1.G102-0557.2 G1020557
GDB1289	B1.G102-0395.2 G1020395	GDB1367	B1.G102-0524.2 G1020524	GDB1441	B1.G102-0392.2 G1020392
GDB1290	B1.G102-0342.2 G1020342	GDB1368	B1.G102-0533.2 G1020533	GDB1442	B1.G102-0624.2 G1020624
GDB1291	B1.G102-0340.2 G1020340	GDB1369	B1.G102-0654.2 G1020654	GDB1443	B1.G102-0496.2 G1020496
GDB1292	B1.G102-0440.2 G1020440	GDB1369	B1.G102-0658.2 G1020658	GDB1444	B1.G102-0500.2 G1020500
GDB1293	B1.G102-0440.2 G1020440	GDB1372	B1.G102-0492.2 G1020492	GDB1445	B1.G102-0473.2 G1020473
GDB1293	B1.G120-1272.2 G1201272	GDB1373	B1.G102-0582.2 G1020582	GDB1448	B1.G102-0602.2 G1020602
GDB1294	B1.G102-0444.2 G1020444	GDB1376	B1.G102-0312.2 G1020312	GDB1449	B1.G102-0603.2 G1020603
GDB1295	B1.G102-0570.2 G1020570	GDB1377	B1.G102-0955.2 G1020955	GDB1450	B1.G102-0604.2 G1020604
GDB1297	B1.G102-0141.2 G1020141	GDB1382	B1.G102-0469.2 G1020469	GDB1454	B1.G102-0574.2 G1020574
GDB1299	B1.G102-0305.2 G1020305	GDB1383	B1.G102-0448.2 G1020448	GDB1457	B1.G102-0575.2 G1020575
GDB1300	B1.G102-0258.2 G1020258	GDB1384	B1.G102-0567.2 G1020567	GDB1459	B1.G102-0527.2 G1020527
GDB1302	B1.G102-0271.2 G1020271	GDB1385	B1.G102-0513.2 G1020513	GDB1460	B1.G102-0580.2 G1020580
GDB1304	B1.G102-0367.2 G1020367	GDB1386	B1.G102-0463.2 G1020463	GDB1461	B1.G102-0595.2 G1020595
GDB1305	B1.G102-0216.2 G1020216	GDB1387	B1.G102-0342.2 G1020342	GDB1464	B1.G102-0614.2 G1020614
GDB1305	B1.G102-0522.2 G1020522	GDB1388	B1.G102-0578.2 G1020578	GDB1464	B1.G102-0735.2 G1020735
GDB1306	B1.G102-0390.2 G1020390	GDB1389	B1.G102-0480.2 G1020480	GDB1465	B1.G102-0501.2 G1020501
GDB1307	B1.G102-0313.2 G1020313	GDB1390	B1.G102-0570.2 G1020570	GDB1466	B1.G102-0633.2 G1020633
GDB1310	B1.G102-0246.2 G1020246	GDB1391	B1.G102-0534.2 G1020534	GDB1467	B1.G102-0489.2 G1020489
GDB1312	B1.G102-0444.2 G1020444	GDB1393	B1.G102-0389.2 G1020389	GDB1468	B1.G102-0547.2 G1020547

# Cross reference list

Liste des correspondances / Tabella di conversione codici / Lista de comparação /



Lista porównawcza numerów / Porovnávací seznam čísel

LUCAS (TRW) 		LUCAS (TRW) 		LUCAS (TRW) 	
GDB1468	B1.G102-0548.2 G1020548	GDB1547	B1.G102-0709.2 G1020709	GDB1621	B1.G102-0727.2 G1020727
GDB1469	B1.G102-0470.2 G1020470	GDB1548	B1.G102-0710.2 G1020710	GDB1621	B1.G120-1069.2 G1201069
GDB1470	B1.G102-0627.2 G1020627	GDB1549	B1.G102-0711.2 G1020711	GDB1622	B1.G102-0682.2 G1020682
GDB1471	B1.G102-0554.2 G1020554	GDB1550	B1.G102-0680.2 G1020680	GDB1622	B1.G102-0734.2 G1020734
GDB1472	B1.G102-0733.2 G1020733	GDB1551	B1.G102-0682.2 G1020682	GDB1624	B1.G102-0735.2 G1020735
GDB1473	B1.G102-0901.2 G1020901	GDB1551	B1.G102-0734.2 G1020734	GDB1625	B1.G102-0846.2 G1020846
GDB1475	B1.G102-0566.2 G1020566	GDB1552	B1.G102-0685.2 G1020685	GDB1626	B1.G102-0850.2 G1020850
GDB1476	B1.G102-0646.2 G1020646	GDB1553	B1.G102-0678.2 G1020678	GDB1628	B1.G102-0829.2 G1020829
GDB1477	B1.G102-0648.2 G1020648	GDB1554	B1.G102-0754.2 G1020754	GDB1629	B1.G102-0661.2 G1020661
GDB1478	B1.G102-0633.2 G1020633	GDB1555	B1.G102-0707.2 G1020707	GDB1630	B1.G102-0855.2 G1020855
GDB1479	B1.G102-0529.2 G1020529	GDB1556	B1.G102-0706.2 G1020706	GDB1633	B1.G102-0830.2 G1020830
GDB148	B1.G102-0065.2 G1020065	GDB1557	B1.G102-0691.2 G1020691	GDB1634	B1.G102-0501.2 G1020501
GDB1480	B1.G102-0615.2 G1020615	GDB1558	B1.G102-0746.2 G1020746	GDB1635	B1.G102-0501.2 G1020501
GDB1481	B1.G102-0544.2 G1020544	GDB1559	B1.G102-0586.2 G1020586	GDB1637	B1.G102-0672.2 G1020672
GDB1481	B1.G102-0852.2 G1020852	GDB1559	B1.G102-0848.2 G1020848	GDB1638	B1.G102-0672.2 G1020672
GDB1482	B1.G102-0740.2 G1020740	GDB1560	B1.G102-0588.2 G1020588	GDB1639	B1.G102-0290.2 G1020290
GDB1483	B1.G102-0503.2 G1020503	GDB1560	B1.G102-0887.2 G1020887	GDB1642	B1.G102-0860.2 G1020860
GDB1483	B1.G102-0738.2 G1020738	GDB1561	B1.G102-0648.2 G1020648	GDB1643	B1.G102-0862.2 G1020862
GDB1484	B1.G102-0504.2 G1020504	GDB1562	B1.G102-0765.2 G1020765	GDB1646	B1.G102-0568.2 G1020568
GDB1485	B1.G102-0515.2 G1020515	GDB1564	B1.G102-0340.2 G1020340	GDB1647	B1.G102-0701.2 G1020701
GDB1487	B1.G102-0484.2 G1020484	GDB1565	B1.G102-0696.2 G1020696	GDB1649	B1.G102-0572.2 G1020572
GDB1488	B1.G102-0313.2 G1020313	GDB1567	B1.G102-0756.2 G1020756	GDB1650	B1.G102-0572.2 G1020572
GDB1490	B1.G102-0572.2 G1020572	GDB1570	B1.G102-0545.2 G1020545	GDB1651	B1.G102-0704.2 G1020704
GDB1492	B1.G102-0650.2 G1020650	GDB1572	B1.G102-0617.2 G1020617	GDB1652	B1.G102-0711.2 G1020711
GDB1495	B1.G102-0686.2 G1020686	GDB1573	B1.G102-0618.2 G1020618	GDB1653	B1.G102-0711.2 G1020711
GDB1496	B1.G102-0687.2 G1020687	GDB1574	B1.G102-0633.2 G1020633	GDB1654	B1.G102-0737.2 G1020737
GDB1498	B1.G102-0634.2 G1020634	GDB1576	B1.G102-0694.2 G1020694	GDB1655	B1.G102-0738.2 G1020738
GDB1499	B1.G102-0637.2 G1020637	GDB1578	B1.G102-0755.2 G1020755	GDB1657	B1.G102-0650.2 G1020650
GDB1501	B1.G102-0513.2 G1020513	GDB1580	B1.G102-0885.2 G1020885	GDB1658	B1.G102-0463.2 G1020463
GDB1502	B1.G102-0638.2 G1020638	GDB1581	B1.G102-0886.2 G1020886	GDB1659	B1.G102-0754.2 G1020754
GDB1503	B1.G102-0514.2 G1020514	GDB1583	B1.G102-0622.2 G1020622	GDB1663	B1.G102-0762.2 G1020762
GDB1504	B1.G102-0549.2 G1020549	GDB1584	B1.G102-0779.2 G1020779	GDB1665	B1.G102-0625.2 G1020625
GDB1509	B1.G102-0563.2 G1020563	GDB1586	B1.G102-0409.2 G1020409	GDB1667	B1.G102-0877.2 G1020877
GDB1514	B1.G102-0925.2 G1020925	GDB1587	B1.G102-0492.2 G1020492	GDB1668	B1.G102-0765.2 G1020765
GDB1515	B1.G102-0610.2 G1020610	GDB1588	B1.G102-0496.2 G1020496	GDB1669	B1.G102-0735.2 G1020735
GDB1516	B1.G102-0758.2 G1020758	GDB1589	B1.G102-0613.2 G1020613	GDB1670	B1.G120-1010.2 G1201010
GDB1516	B1.G102-0759.2 G1020759	GDB1590	B1.G102-0740.2 G1020740	GDB1671	B1.G102-0699.2 G1020699
GDB1517	B1.G102-0516.2 G1020516	GDB1591	B1.G102-0614.2 G1020614	GDB1672	B1.G102-0698.2 G1020698
GDB1518	B1.G102-0518.2 G1020518	GDB1592	B1.G102-0573.2 G1020573	GDB1673	B1.G102-0774.2 G1020774
GDB1520	B1.G102-0568.2 G1020568	GDB1593	B1.G102-0573.2 G1020573	GDB1676	B1.G102-0735.2 G1020735
GDB1521	B1.G102-0517.2 G1020517	GDB1594	B1.G102-0761.2 G1020761	GDB1678	B1.G102-0630.2 G1020630
GDB1522	B1.G102-0216.2 G1020216	GDB1595	B1.G102-0762.2 G1020762	GDB1678	B1.G102-0995.2 G1020995
GDB1522	B1.G102-0522.2 G1020522	GDB1596	B1.G102-0660.2 G1020660	GDB1681	B1.G102-0763.2 G1020763
GDB1524	B1.G102-0685.2 G1020685	GDB1597	B1.G102-0685.2 G1020685	GDB1681	B1.G102-0872.2 G1020872
GDB1525	B1.G102-0563.2 G1020563	GDB1600	B1.G102-0751.2 G1020751	GDB1682	B1.G102-0730.2 G1020730
GDB1527	B1.G102-0367.2 G1020367	GDB1601	B1.G102-0752.2 G1020752	GDB1683	B1.G102-0889.2 G1020889
GDB1528	B1.G102-0644.2 G1020644	GDB1604	B1.G102-0568.2 G1020568	GDB1684	B1.G120-1009.2 G1201009
GDB1530	B1.G102-0367.2 G1020367	GDB1605	B1.G102-0745.2 G1020745	GDB1685	B1.G102-0787.2 G1020787
GDB1531	B1.G102-0591.2 G1020591	GDB1607	B1.G102-0772.2 G1020772	GDB1685	B1.G102-0900.2 G1020900
GDB1532	B1.G102-0692.2 G1020692	GDB1611	B1.G102-0794.2 G1020794	GDB1686	B1.G102-0650.2 G1020650
GDB1538	B1.G102-0593.2 G1020593	GDB1612	B1.G102-0844.2 G1020844	GDB1687	B1.G102-0871.2 G1020871
GDB1540	B1.G102-0576.2 G1020576	GDB1613	B1.G102-0650.2 G1020650	GDB1689	B1.G102-0895.2 G1020895
GDB1542	B1.G102-0632.2 G1020632	GDB1614	B1.G102-0741.2 G1020741	GDB1690	B1.G102-0790.2 G1020790
GDB1543	B1.G102-0677.2 G1020677	GDB1616	B1.G102-0753.2 G1020753	GDB1691	B1.G102-0792.2 G1020792
GDB1545	B1.G102-0441.2 G1020441	GDB1617	B1.G102-0754.2 G1020754	GDB1692	B1.G102-0799.2 G1020799
GDB1546	B1.G102-0652.2 G1020652	GDB1620	B1.G102-0630.2 G1020630	GDB1693	B1.G102-0659.2 G1020659
GDB1546	B1.G102-0985.2 G1020985	GDB1621	B1.G102-0670.2 G1020670	GDB1696	B1.G102-0770.2 G1020770

# Cross reference list

Liste des correspondances / Tabella di conversione codici / Lista de comparação /

Lista porównawcza numerów / Porovnávací seznam čísel



LUCAS (TRW)		LUCAS (TRW)		LUCAS (TRW)				
GDB1697	B1.G102-0766.2	G1020766	GDB1808	B1.G102-0834.2	G1020834	GDB3425	B1.G120-1065.2	G1201065
GDB1697	B1.G102-0922.2	G1020922	GDB1818	B1.G120-1073.2	G1201073	GDB3426	B1.G120-1022.2	G1201022
GDB1698	B1.G102-0769.2	G1020769	GDB1827	B1.G120-1213.2	G1201213	GDB3436	B1.G120-1085.2	G1201085
GDB1699	B1.G102-0940.2	G1020940	GDB1828	B1.G102-0946.2	G1020946	GDB3437	B1.G120-1053.2	G1201053
GDB1700	B1.G102-0858.2	G1020858	GDB1829	B1.G120-1225.2	G1201225	GDB3443	B1.G120-1085.2	G1201085
GDB1701	B1.G102-0833.2	G1020833	GDB1842	B1.G120-1224.2	G1201224	GDB3445	B1.G102-0817.2	G1020817
GDB1702	B1.G102-0368.2	G1020368	GDB1844	B1.G102-0953.2	G1020953	GDB3446	B1.G102-0819.2	G1020819
GDB1703	B1.G102-0764.2	G1020764	GDB1903	B1.G102-0907.2	G1020907	GDB3450	B1.G120-1002.2	G1201002
GDB1703	B1.G102-0873.2	G1020873	GDB199	B1.G102-0015.2	G1020015	GDB3451	B1.G120-1035.2	G1201035
GDB1704	B1.G102-0730.2	G1020730	GDB255	B1.G102-0334.2	G1020334	GDB3454	B1.G102-0975.2	G1020975
GDB1706	B1.G102-0896.2	G1020896	GDB294	B1.G102-0022.2	G1020022	GDB3457	B1.G102-0798.2	G1020798
GDB1707	B1.G102-0896.2	G1020896	GDB297	B1.G102-0141.2	G1020141	GDB3458	B1.G102-0666.2	G1020666
GDB1712	B1.G102-0856.2	G1020856	GDB3110	B1.G120-5404.2	G1205404	GDB3460	B1.G102-0974.2	G1020974
GDB1715	B1.G102-0979.2	G1020979	GDB3113	B1.G120-1000.2	G1201000	GDB3464	B1.G120-5404.2	G1205404
GDB1716	B1.G102-0981.2	G1020981	GDB3116	B1.G102-0258.2	G1020258	GDB3467	B1.G102-0866.2	G1020866
GDB1717	B1.G102-0403.2	G1020403	GDB3174	B1.G120-1000.2	G1201000	GDB371	B1.G102-0026.2	G1020026
GDB1718	B1.G102-0937.2	G1020937	GDB3178	B1.G102-0334.2	G1020334	GDB400	B1.G102-0501.2	G1020501
GDB1719	B1.G102-0937.2	G1020937	GDB3194	B1.G102-0721.2	G1020721	GDB404	B1.G102-0197.2	G1020197
GDB1720	B1.G102-0709.2	G1020709	GDB3231	B1.G102-0721.2	G1020721	GDB4084	B1.G102-0885.2	G1020885
GDB1722	B1.G120-1011.2	G1201011	GDB3237	B1.G120-1056.2	G1201056	GDB4118	B1.G120-5215.2	G1205215
GDB1723	B1.G102-0800.2	G1020800	GDB3242	B1.G102-0714.2	G1020714	GDB4119	B1.G120-5203.2	G1205203
GDB1724	B1.G102-0801.2	G1020801	GDB3247	B1.G120-5230.2	G1205230	GDB4119IS	B1.G120-5203.2	G1205203
GDB1725	B1.G102-0802.2	G1020802	GDB3250	B1.G120-5344.2	G1205344	GDB4126	B1.G120-5238.2	G1205238
GDB1726	B1.G102-0806.2	G1020806	GDB327	B1.G102-0214.2	G1020214	GDB4128	B1.G120-5366.2	G1205366
GDB1727	B1.G102-0588.2	G1020588	GDB328	B1.G102-0219.2	G1020219	GDB4130	B1.G120-5234.2	G1205234
GDB1729	B1.G102-0939.2	G1020939	GDB328	B1.G102-0323.2	G1020323	GDB425	B1.G102-0326.2	G1020326
GDB1730	B1.G102-0803.2	G1020803	GDB3280	B1.G120-5404.2	G1205404	GDB442	B1.G102-0955.2	G1020955
GDB1732	B1.G102-0786.2	G1020786	GDB3287	B1.G120-5241.2	G1205241	GDB446	B1.G102-0213.2	G1020213
GDB1732	B1.G120-1135.2	G1201135	GDB3288	B1.G102-0712.2	G1020712	GDB454	B1.G102-0009.2	G1020009
GDB1733	B1.G102-0877.2	G1020877	GDB3289	B1.G102-0713.2	G1020713	GDB458	B1.G102-0140.2	G1020140
GDB1736	B1.G102-0933.2	G1020933	GDB3292	B1.G102-0470.2	G1020470	GDB459	B1.G102-0010.2	G1020010
GDB1736	B1.G102-0934.2	G1020934	GDB3310	B1.G102-0719.2	G1020719	GDB463	B1.G102-0025.2	G1020025
GDB1740	B1.G102-0938.2	G1020938	GDB3311	B1.G102-0721.2	G1020721	GDB466	B1.G102-0236.2	G1020236
GDB1741	B1.G102-0763.2	G1020763	GDB3314	B1.G120-5242.2	G1205242	GDB472	B1.G102-0028.2	G1020028
GDB1741	B1.G102-0872.2	G1020872	GDB3317	B1.G102-0714.2	G1020714	GDB648	B1.G102-0097.2	G1020097
GDB1742	B1.G102-0882.2	G1020882	GDB3324	B1.G102-0478.2	G1020478	GDB695	B1.G102-0147.2	G1020147
GDB1745	B1.G102-0951.2	G1020951	GDB3328	B1.G120-5418.2	G1205418	GDB7075	B1.G102-0714.2	G1020714
GDB1747	B1.G102-0828.2	G1020828	GDB3332	B1.G102-0538.2	G1020538	GDB7224	B1.G120-5242.2	G1205242
GDB1748	B1.G102-0825.2	G1020825	GDB3332	B1.G102-0741.2	G1020741	GDB7691	B1.G120-1059.2	G1201059
GDB1750	B1.G102-0614.2	G1020614	GDB3336	B1.G102-0662.2	G1020662	GDB7714	B1.G120-1022.2	G1201022
GDB1761	B1.G102-0859.2	G1020859	GDB3337	B1.G102-0663.2	G1020663	GDB7728	B1.G102-0974.2	G1020974
GDB1764	B1.G120-1066.2	G1201066	GDB3342	B1.G120-1002.2	G1201002	GDB7729	B1.G102-0975.2	G1020975
GDB1765	B1.G120-1004.2	G1201004	GDB3344	B1.G120-1025.2	G1201025	GDB7734	B1.G102-0727.2	G1020727
GDB1765	B1.G120-1005.2	G1201005	GDB3355	B1.G102-0812.2	G1020812	GDB788	B1.G102-0213.2	G1020213
GDB1766	B1.G102-0796.2	G1020796	GDB3363	B1.G102-0605.2	G1020605	GDB790	B1.G102-0299.2	G1020299
GDB1774	B1.G120-1079.2	G1201079	GDB3364	B1.G120-5333.2	G1205333	GDB791	B1.G102-0315.2	G120315
GDB1775	B1.G102-0999.2	G1020999	GDB3369	B1.G120-1047.2	G1201047	GDB792	B1.G102-0326.2	G1020326
GDB1778	B1.G102-0785.2	G1020785	GDB3371	B1.G120-5418.2	G1205418	GDB794	B1.G102-0269.2	G1020269
GDB1781	B1.G120-1147.2	G1201147	GDB3375	B1.G102-0722.2	G1020722	GDB808	B1.G102-0213.2	G1020213
GDB1782	B1.G120-1143.2	G1201143	GDB3389	B1.G102-0537.2	G1020537	GDB809	B1.G102-0501.2	G1020501
GDB1783	B1.G120-1145.2	G1201145	GDB3392	B1.G120-1029.2	G1201029	GDB817	B1.G102-0257.2	G1020257
GDB1784	B1.G120-1148.2	G1201148	GDB3396	B1.G120-1059.2	G1201059	GDB818	B1.G102-0044.2	G1020044
GDB1784	B1.G120-1149.2	G1201149	GDB3407	B1.G120-1013.2	G1201013	GDB823	B1.G102-0201.2	G1020201
GDB1785	B1.G102-0875.2	G1020875	GDB3408	B1.G120-1014.2	G1201014	GDB826	B1.G102-0274.2	G1020274
GDB1786	B1.G102-0874.2	G1020874	GDB3420	B1.G120-1033.2	G1201033	GDB833	B1.G102-0184.2	G1020184
GDB1789	B1.G120-1126.2	G1201126	GDB3421	B1.G120-1035.2	G1201035	GDB852	B1.G102-0184.2	G1020184
GDB1790	B1.G102-0834.2	G1020834	GDB3424	B1.G102-0994.2	G1020994	GDB854	B1.G102-0196.2	G1020196



# Cross reference list

Liste des correspondances / Tabella di conversione codici / Lista de comparação /



Lista porównawcza numerów / Porovnávací seznam čísel

MERCEDES BENZ 			MERCEDES BENZ 			MERCEDES BENZ 		
004 420 04 20 67	B1.G102-0574.2	G1020574	006 420 84 20	B1.G102-0769.2	G1020769	211 421 10 12	B1.G232-0144.1	G2132144
004 420 05 20	B1.G102-0677.2	G1020677	124 423 05 12	B1.G209-0114.1	G2109114	211 421 13 12	B1.G232-0144.1	G2132144
004 420 05 20 67	B1.G102-0677.2	G1020677	163 420 06 20	B1.G102-0574.2	G1020574	211 421 14 12	B1.G232-0144.1	G2132144
004 420 07 20	B1.G102-0776.2	G1020776	163 420 07 20	B1.G102-0575.2	G1020575	211 423 07 12	B1.G210-0278.1	G2110278
004 420 15 20	B1.G102-0891.2	G1020891	163 420 08 20	B1.G102-0574.2	G1020574	220 421 08 12	B1.G232-0115.1	G2132115
004 420 16 20	B1.G102-0400.2	G1020400	163 420 08 20 27	B1.G102-0574.2	G1020574	220 421 09 12	B1.G228-0125.1	G2128125
004 420 17 20	B1.G102-0441.2	G1020441	163 420 09 20	B1.G102-0575.2	G1020575	220 421 25 12	B1.G232-0115.1	G2132115
004 420 18 20	B1.G102-0397.2	G1020397	163 420 11 20	B1.G102-0575.2	G1020575	230 421 05 12	B1.G232-0153.1	G2132153
004 420 24 20	B1.G102-0891.2	G1020891	163 421 03 12	B1.G232-0114.1	G2132114	230 421 08 12	B1.G232-0153.1	G2132153
004 420 27 20	B1.G102-0397.2	G1020397	163 421 05 12	B1.G232-0114.1	G2132114	414 420 01 20	B1.G102-0544.2	G1020544
004 420 40 20	B1.G102-0860.2	G1020860	164 420 08 20	B1.G102-0860.2	G1020860	414 420 02 20	B1.G102-0615.2	G1020615
004 420 44 20	B1.G102-0652.2	G1020652	164 420 15 20	B1.G102-0862.2	G1020862	415 420 00 01	B1.G224-0222.1	G2124222
004 420 51 20	B1.G102-0659.2	G1020659	164 420 18 20	B1.G102-0860.2	G1020860	415 420 01 01	B1.G222-0270.1	G2122270
004 420 52 20	B1.G102-0862.2	G1020862	168 420 00 20	B1.G102-0440.2	G1020440	415 421 04 10	B1.G102-0874.2	G1020874
004 420 55 20	B1.G102-0742.2	G1020742	168 420 01 20	B1.G120-1272.2	G1201272	415 421 04 12	B1.G224-0222.1	G2124222
004 420 56 20	B1.G102-0396.2	G1020396	168 420 04 20	B1.G102-0544.2	G1020544	415 421 05 10	B1.G102-0741.2	G1020741
004 420 62 20	B1.G102-0877.2	G1020877	168 420 07 20	B1.G120-1272.2	G1201272	415 421 06 10	B1.G102-0876.2	G1020876
004 420 67 20	B1.G102-0769.2	G1020769	168 420 12 20	B1.G102-0440.2	G1020440	901 421 03 12	B1.G222-0161.1	G2122161
004 420 68 20	B1.G102-0770.2	G1020770	168 420 13 20	B1.G120-1272.2	G1201272	902 421 03 12	B1.G222-0161.1	G2122161
004 420 69 20	B1.G102-0922.2	G1020922	168 420 14 20	B1.G120-1272.2	G1201272	902 421 04 12	B1.G222-0161.1	G2122161
004 420 79 20	B1.G102-0632.2	G1020632	168 420 15 20	B1.G102-0440.2	G1020440	902 421 06 12	B1.G222-0161.1	G2122161
004 420 80 20	B1.G102-0877.2	G1020877	168 421 01 12	B1.G212-0144.1	G2112144	902 421 07 12	B1.G222-0161.1	G2122161
004 420 81 20	B1.G102-0940.2	G1020940	169 420 01 20	B1.G102-0829.2	G1020829	902 421 09 12	B1.G222-0161.1	G2122161
004 420 82 20	B1.G102-0770.2	G1020770	169 420 02 20	B1.G102-0661.2	G1020661	906 421 00 12	B1.G228-0203.1	G2128203
004 420 83 20	B1.G102-0769.2	G1020769	169 420 03 20	B1.G102-0855.2	G1020855	H WA 210 420 01 20	B1.G102-0683.2	G1020683
004 420 87 20	B1.G102-0632.2	G1020632	169 420 04 20	B1.G102-0852.2	G1020852			
004 420 90 20	B1.G102-0677.2	G1020677	169 420 07 20	B1.G102-0855.2	G1020855			
004 420 91 20	B1.G102-0441.2	G1020441	169 420 08 20	B1.G102-0829.2	G1020829			
005 420 03 20	B1.G102-0337.2	G1020337	169 420 09 20	B1.G102-0855.2	G1020855			
005 420 07 20	B1.G102-0963.2	G1020963	169 420 10 20	B1.G102-0661.2	G1020661			
005 420 08 20	B1.G102-0933.2	G1020933	169 420 11 20	B1.G102-0852.2	G1020852			
005 420 09 20	B1.G102-0934.2	G1020934	169 420 13 20	B1.G102-0855.2	G1020855			
005 420 10 20	B1.G102-0935.2	G1020935	169 420 14 20	B1.G102-0852.2	G1020852			
005 420 13 20	B1.G102-0935.2	G1020935	169 420 17 20	B1.G102-0852.2	G1020852			
005 420 15 20	B1.G102-0933.2	G1020933	169 421 01 12	B1.G222-0232.1	G2122232			
005 420 16 20	B1.G102-0935.2	G1020935	169 421 08 12	B1.G222-0232.1	G2122232			
005 420 17 20	B1.G102-0339.2	G1020339	169 423 03 12	B1.G208-0113.1	G2108113			
005 420 19 20	B1.G102-0442.2	G1020442	169 423 09 12	B1.G208-0113.1	G2108113			
005 420 21 20	B1.G102-0769.2	G1020769	201 423 09 12	B1.G209-0120.1	G2109120			
005 420 42 20	B1.G102-0963.2	G1020963	201 423 11 12	B1.G209-0120.1	G2109120			
005 420 43 20	B1.G102-0963.2	G1020963	201 423 12 12	B1.G209-0120.1	G2109120			
005 420 52 20	B1.G102-0769.2	G1020769	202 423 00 12	B1.G209-0120.1	G2109120			
005 420 70 20	B1.G102-0769.2	G1020769	203 421 03 12	B1.G225-0110.1	G2125110			
005 420 74 20	B1.G102-0940.2	G1020940	203 421 13 12	B1.G228-0177.1	G2128177			
005 420 78 20	B1.G102-0877.2	G1020877	203 423 01 12	B1.G209-0114.1	G2109114			
005 420 79 20	B1.G102-0985.2	G1020985	204 421 29 12	B1.G232-0144.1	G2132144			
005 420 81 20	B1.G102-0963.2	G1020963	210 421 07 12	B1.G225-0110.1	G2125110			
005 420 93 20	B1.G102-0985.2	G1020985	210 421 24 12	B1.G225-0110.1	G2125110			
005 420 94 20	B1.G102-0985.2	G1020985	210 423 01 12	B1.G209-0114.1	G2109114			
006 420 12 20	B1.G102-0574.2	G1020574	210 423 03 12	B1.G210-0217.1	G2110217			
006 420 13 20	B1.G102-0963.2	G1020963	210 423 04 12	B1.G209-0114.1	G2109114			
006 420 22 20	B1.G102-0940.2	G1020940	210 423 06 12	B1.G210-0217.1	G2110217			
006 420 28 20	B1.G102-0935.2	G1020935	210 423 09 12	B1.G209-0114.1	G2109114			
006 420 32 20	B1.G102-0677.2	G1020677	210 423 10 12	B1.G210-0217.1	G2110217			
006 420 43 20	B1.G102-0751.2	G1020751	211 421 07 12	B1.G228-0176.1	G2128176			
006 420 45 20	B1.G102-0940.2	G1020940	211 421 08 12	B1.G228-0176.1	G2128176			
006 420 61 20	B1.G102-0963.2	G1020963	211 421 09 12	B1.G228-0142.1	G2128142			
						<b>MG ROVER</b>		
						SFP000040	B1.G102-0591.2	G1020591
						SFP100520	B1.G102-0316.2	G1020316
						<b>MINI</b>		
						34 11 1 502 891	B1.G222-0204.1	G2122204
						34 11 1 503 076	B1.G102-0646.2	G1020646
						34 11 6 761 287	B1.G102-0646.2	G1020646
						34 11 6 765 446	B1.G102-0646.2	G1020646
						34 11 6 770 251	B1.G102-0856.2	G1020856
						34 11 6 772 892	B1.G102-0794.2	G1020794
						34 11 6 778 320	B1.G102-0856.2	G1020856
						34 11 9 804 735	B1.G102-0856.2	G1020856
						34 21 1 503 070	B1.G210-0271.1	G2110271
						34 21 1 503 077	B1.G102-0648.2	G1020648
						34 21 6 761 288	B1.G102-0648.2	G1020648
						34 21 6 762 871	B1.G102-0648.2	G1020648
						34 21 6 774 987	B1.G210-0271.1	G2110271
						34 21 6 778 327	B1.G102-0796.2	G1020796
						34 21 9 804 739	B1.G102-0844.2	G1020844
						34 21 9 808 172	B1.G102-0844.2	G1020844
						<b>MITSUBISHI</b>		
						4605A261	B1.G120-5241.2	G1205241
						4605A447	B1.G120-5230.2	G1205230
						4605A448	B1.G120-5230.2	G1205230
						4605A458	B1.G120-5404.2	G1205404
						4605A472	B1.G120-5333.2	G1205333
						4605A481	B1.G120-5333.2	G1205333
						4605A487	B1.G120-5230.2	G1205230
						4605A491	B1.G120-5241.2	G1205241

# Cross reference list

Liste des correspondances / Tabella di conversione codici / Lista de comparação /



Lista porównawcza numerów / Porovnávací seznam čísel

MITSUBISHI 		NISSAN 		OPEL 	
4605A502	B1.G120-5230.2 G1205230	44060-00QAF	B1.G102-0529.2 G1020529	13319294	B1.G102-0953.2 G1020953
4605A557	B1.G120-5241.2 G1205241	44060-AV625	B1.G102-0470.2 G1020470	13322091	B1.G102-0727.2 G1020727
4605A734	B1.G102-0779.2 G1020779	44060-AV725	B1.G102-0470.2 G1020470	13338368	B1.G120-1149.2 G1201149
4605A795	B1.G120-5241.2 G1205241	44060-BA00F	B1.G102-0470.2 G1020470	13343450	B1.G120-1148.2 G1201148
4605A879	B1.G120-5241.2 G1205241	D1060-1HA0A	B1.G120-1059.2 G1201059	13343451	B1.G120-1149.2 G1201149
M620770	B1.G102-0458.2 G1020458	D1060-AX60A	B1.G102-0741.2 G1020741	13411383	B1.G102-0953.2 G1020953
M850976	B1.G102-0537.2 G1020537	D1060-JD00A	B1.G102-0866.2 G1020866	20789468	B1.G102-0979.2 G1020979
M850978	B1.G102-0458.2 G1020458			22799077	B1.G102-0928.2 G1020928
MB699288	B1.G210-0229.1 G2110229	<b>OPEL</b>		90008005	B1.G213-0161.1 G2113161
MN102618	B1.G120-5241.2 G1205241	3487287	B1.G102-0015.2 G1020015	90008006	B1.G220-0115.1 G2120115
MN102628	B1.G120-5230.2 G1205230	3487299	B1.G102-0015.2 G1020015	90008031	B1.G213-0161.1 G2113161
MN125772	B1.G102-0780.2 G1020780	9110993	B1.G102-0624.2 G1020624	90008032	B1.G220-0115.1 G2120115
MR235557	B1.G102-0457.2 G1020457	9111045	B1.G212-0155.1 G2112155	90010584	B1.G102-0015.2 G1020015
MR249241	B1.G102-0457.2 G1020457	9111467	B1.G102-0627.2 G1020627	90010585	B1.G102-0015.2 G1020015
MR249356	B1.G210-0229.1 G2110229	9112585	B1.G102-0624.2 G1020624	90114901	B1.G102-0015.2 G1020015
MR407946	B1.G102-0457.2 G1020457	9117677	B1.G224-0152.1 G2124152	90166278	B1.G102-0015.2 G1020015
MR510544	B1.G120-5230.2 G1205230	9117678	B1.G225-0131.1 G2125131	90167334	B1.G102-0015.2 G1020015
MR527656	B1.G102-0537.2 G1020537	9117717	B1.G102-0554.2 G1020554	90167765	B1.G102-0015.2 G1020015
MR527675	B1.G120-5241.2 G1205241	9117771	B1.G210-0251.1 G2110251	90273260	B1.G102-0271.2 G1020271
MR913846	B1.G210-0229.1 G2110229	9117772	B1.G210-0250.1 G2110250	90295087	B1.G224-0115.1 G2124115
MR955351	B1.G102-0537.2 G1020537	9192123	B1.G102-0369.2 G1020369	90295577	B1.G102-0015.2 G1020015
MR977117	B1.G102-0779.2 G1020779	9192125	B1.G102-0271.2 G1020271	90295578	B1.G102-0015.2 G1020015
X3511007	B1.G102-0457.2 G1020457	9192126	B1.G102-0271.2 G1020271	90297357	B1.G102-0015.2 G1020015
X3511010	B1.G102-0537.2 G1020537	9192157	B1.G102-0550.2 G1020550	90297358	B1.G102-0015.2 G1020015
X3516005	B1.G102-0458.2 G1020458	9193251	B1.G102-0554.2 G1020554	90297537	B1.G102-0272.2 G1020272
X3516006	B1.G120-5230.2 G1205230	9193476	B1.G102-0271.2 G1020271	90297770	B1.G102-0258.2 G1020258
		9194477	B1.G225-0142.1 G2125142	90398235	B1.G102-0015.2 G1020015
<b>NISSAN</b>		9194893	B1.G102-0605.2 G1020605	90398758	B1.G102-0015.2 G1020015
40206-00QAA	B1.G221-0106.1 G2121106	9195058	B1.G102-0271.2 G1020271	90398759	B1.G102-0015.2 G1020015
40206-00QAE	B1.G228-0132.1 G2128132	9195064	B1.G102-0642.2 G1020642	90398760	B1.G102-0258.2 G1020258
40206-00QAF	B1.G228-0132.1 G2128132	9195144	B1.G102-0542.2 G1020542	90398800	B1.G102-0015.2 G1020015
40206-00QAG	B1.G228-0132.1 G2128132	9195145	B1.G102-0550.2 G1020550	90399437	B1.G102-0015.2 G1020015
40206-00QAH	B1.G228-0132.1 G2128132	9195146	B1.G102-0403.2 G1020403	90399495	B1.G102-0258.2 G1020258
40206-00QAJ	B1.G220-0125.1 G2120125	9195607	B1.G102-0542.2 G1020542	90421528	B1.G102-0271.2 G1020271
40206-5F001	B1.G212-0137.1 G2112137	9195641	B1.G102-0554.2 G1020554	90421727	B1.G220-0140.1 G2120140
40206-5F003	B1.G212-0137.1 G2112137	9195685	B1.G102-0554.2 G1020554	90421736	B1.G102-0317.2 G1020317
40206-AX600	B1.G222-0216.1 G2122216	9195981	B1.G211-0152.1 G2111152	90442385	B1.G102-0015.2 G1020015
40206-AX603	B1.G222-0216.1 G2122216	9195985	B1.G220-0174.1 G2120174	90442995	B1.G102-0317.2 G1020317
40206-JD00A	B1.G226-0154.1 G2126154	9196050	B1.G224-0166.1 G2124166	90443873	B1.G102-0369.2 G1020369
40206-JG00A	B1.G226-0154.1 G2126154	9196587	B1.G210-0251.1 G2110251	90443902	B1.G102-0015.2 G1020015
41060-00QAD	B1.G102-0624.2 G1020624	9198598	B1.G102-0554.2 G1020554	90444513	B1.G212-0131.1 G2112131
41060-00QAE	B1.G102-0633.2 G1020633	9198688	B1.G102-0403.2 G1020403	90485136	B1.G102-0272.2 G1020272
41060-00QAF	B1.G102-0497.2 G1020497	9199257	B1.G102-0633.2 G1020633	90485138	B1.G102-0271.2 G1020271
41060-00QAG	B1.G102-0497.2 G1020497	9199262	B1.G102-0529.2 G1020529	90485140	B1.G102-0317.2 G1020317
41060-AX625	B1.G102-0538.2 G1020538	9200108	B1.G102-0545.2 G1020545	90487271	B1.G102-0271.2 G1020271
41060-CC090	B1.G120-1029.2 G1201029	9200132	B1.G102-0560.2 G1020560	90487402	B1.G224-0115.1 G2124115
41060-EB325	B1.G120-1029.2 G1201029	9201354	B1.G102-0271.2 G1020271	90510331	B1.G102-0317.2 G1020317
43206-00QAA	B1.G212-0155.1 G2112155	9214424	B1.G102-0605.2 G1020605	90511111	B1.G220-0115.1 G2120115
43206-4U101	B1.G210-0285.1 G2110285	9214835	B1.G102-0605.2 G1020605	90511128	B1.G220-0140.1 G2120140
43206-4U103	B1.G210-0285.1 G2110285	13237750	B1.G120-1143.2 G1201143	90511162	B1.G102-0258.2 G1020258
43206-5F001	B1.G207-0109.1 G2107109	13237751	B1.G120-1145.2 G1201145	90512029	B1.G225-0119.1 G2125119
43206-99J00	B1.G210-0215.1 G2110215	13237752	B1.G120-1147.2 G1201147	90512037	B1.G102-0403.2 G1020403
43206-99J01	B1.G210-0215.1 G2110215	13237765	B1.G120-1148.2 G1201148	90512909	B1.G210-0225.1 G2110225
43206-JD00A	B1.G209-0157.1 G2109157	13237766	B1.G120-1149.2 G1201149	90540177	B1.G102-0271.2 G1020271
44060-00Q0H	B1.G102-0907.2 G1020907	13300867	B1.G102-0953.2 G1020953	90544001	B1.G102-0550.2 G1020550
44060-00Q0L	B1.G102-0907.2 G1020907	13301234	B1.G102-0928.2 G1020928	90544025	B1.G102-0542.2 G1020542
44060-00QAE	B1.G102-0627.2 G1020627	13319293	B1.G102-0953.2 G1020953	91159915	B1.G228-0132.1 G2128132

# Cross reference list

Liste des correspondances / Tabella di conversione codici / Lista de comparação /



Lista porównawcza numerów / Porovnávací seznam čísel

OPEL 	OPEL 	OPEL 
91165426	B1.G228-0132.1 G2128132	93192578 B1.G102-0765.2 G1020765
93166798	B1.G102-0650.2 G1020650	93192962 B1.G120-1059.2 G1201059
93167551	B1.G102-0905.2 G1020905	93192978 B1.G220-0211.1 G2120211
93167662	B1.G102-0907.2 G1020907	93196814 B1.G120-1059.2 G1201059
93169143	B1.G102-0610.2 G1020610	93197241 B1.G222-0231.1 G2122231
93169174	B1.G102-0858.2 G1020858	93197592 B1.G225-0131.1 G2125131
93170602	B1.G102-0610.2 G1020610	93197712 B1.G225-0198.1 G2125198
93171035	B1.G102-0542.2 G1020542	95459513 B1.G102-0981.2 G1020981
93171497	B1.G225-0141.1 G2125141	95511282 B1.G222-0145.1 G2122145
93171848	B1.G212-0157.1 G2112157	95513810 B1.G102-0858.2 G1020858
93172174	B1.G102-0650.2 G1020650	96626070 B1.G102-0979.2 G1020979
93172190	B1.G102-0670.2 G1020670	96626076 B1.G102-0981.2 G1020981
93172261	B1.G102-0545.2 G1020545	16 05 000 B1.G102-0542.2 G1020542
93173148	B1.G102-0605.2 G1020605	16 05 003 B1.G102-0369.2 G1020369
93173180	B1.G102-0624.2 G1020624	16 05 005 B1.G102-0271.2 G1020271
93173182	B1.G102-0627.2 G1020627	16 05 006 B1.G102-0271.2 G1020271
93173641	B1.G102-0633.2 G1020633	16 05 009 B1.G102-0550.2 G1020550
93173646	B1.G102-0529.2 G1020529	16 05 025 B1.G102-0554.2 G1020554
93173734	B1.G102-0642.2 G1020642	16 05 026 B1.G102-0271.2 G1020271
93175376	B1.G225-0148.1 G2125148	16 05 031 B1.G102-0271.2 G1020271
93175378	B1.G102-0650.2 G1020650	16 05 032 B1.G102-0642.2 G1020642
93175606	B1.G228-0164.1 G2128164	16 05 034 B1.G102-0542.2 G1020542
93176114	B1.G102-0545.2 G1020545	16 05 035 B1.G102-0550.2 G1020550
93176116	B1.G102-0670.2 G1020670	16 05 036 B1.G102-0403.2 G1020403
93176118	B1.G102-0610.2 G1020610	16 05 039 B1.G102-0554.2 G1020554
93176120	B1.G102-0317.2 G1020317	16 05 047 B1.G102-0271.2 G1020271
93176379	B1.G102-0756.2 G1020756	16 05 065 B1.G102-0727.2 G1020727
93176429	B1.G102-0765.2 G1020765	16 05 070 B1.G102-0542.2 G1020542
93178789	B1.G102-0560.2 G1020560	16 05 079 B1.G102-0756.2 G1020756
93179164	B1.G102-0610.2 G1020610	16 05 080 B1.G102-0765.2 G1020765
93179707	B1.G102-0765.2 G1020765	16 05 081 B1.G102-0545.2 G1020545
93179708	B1.G102-0765.2 G1020765	16 05 086 B1.G102-0610.2 G1020610
93181113	B1.G225-0198.1 G2125198	16 05 087 B1.G102-0317.2 G1020317
93181189	B1.G102-0765.2 G1020765	16 05 091 B1.G102-0542.2 G1020542
93182290	B1.G213-0161.1 G2113161	16 05 093 B1.G102-0554.2 G1020554
93183140	B1.G102-0670.2 G1020670	16 05 094 B1.G102-0650.2 G1020650
93183728	B1.G102-0650.2 G1020650	16 05 095 B1.G102-0650.2 G1020650
93183729	B1.G102-0650.2 G1020650	16 05 098 B1.G102-0650.2 G1020650
93184519	B1.G102-0542.2 G1020542	16 05 099 B1.G102-0765.2 G1020765
93185751	B1.G102-0650.2 G1020650	16 05 103 B1.G120-1148.2 G1201148
93185752	B1.G102-0650.2 G1020650	16 05 104 B1.G120-1149.2 G1201149
93186003	B1.G102-0650.2 G1020650	16 05 105 B1.G102-0554.2 G1020554
93186713	B1.G102-0765.2 G1020765	16 05 113 B1.G102-0650.2 G1020650
93188111	B1.G102-0650.2 G1020650	16 05 117 B1.G102-0670.2 G1020670
93188112	B1.G102-0650.2 G1020650	16 05 121 B1.G102-0542.2 G1020542
93188113	B1.G102-0756.2 G1020756	16 05 122 B1.G102-0610.2 G1020610
93188726	B1.G102-0542.2 G1020542	16 05 123 B1.G102-0981.2 G1020981
93188727	B1.G102-0610.2 G1020610	16 05 136 B1.G102-0650.2 G1020650
93188916	B1.G212-0184.1 G2112184	16 05 137 B1.G102-0650.2 G1020650
93188917	B1.G222-0231.1 G2122231	16 05 138 B1.G102-0756.2 G1020756
93189698	B1.G102-0765.2 G1020765	16 05 139 B1.G102-0650.2 G1020650
93189815	B1.G102-0858.2 G1020858	16 05 140 B1.G102-0953.2 G1020953
93189816	B1.G102-0833.2 G1020833	16 05 180 B1.G102-0953.2 G1020953
93190338	B1.G102-0727.2 G1020727	16 05 184 B1.G102-0858.2 G1020858
93191698	B1.G102-0858.2 G1020858	16 05 196 B1.G102-0727.2 G1020727
93192063	B1.G102-0633.2 G1020633	16 05 198 B1.G102-0633.2 G1020633
93192389	B1.G102-0529.2 G1020529	16 05 199 B1.G102-0529.2 G1020529
		16 05 202 B1.G120-1147.2 G1201147
		16 05 226 B1.G102-0858.2 G1020858
		16 05 252 B1.G102-0765.2 G1020765
		16 05 282 B1.G102-0650.2 G1020650
		16 05 283 B1.G102-0650.2 G1020650
		16 05 353 B1.G102-0858.2 G1020858
		16 05 354 B1.G102-0833.2 G1020833
		16 05 359 B1.G102-0858.2 G1020858
		16 05 366 B1.G120-1149.2 G1201149
		16 05 434 B1.G120-1145.2 G1201145
		16 05 454 B1.G102-0258.2 G1020258
		16 05 455 B1.G102-0317.2 G1020317
		16 05 456 B1.G102-0765.2 G1020765
		16 05 463 B1.G102-0015.2 G1020015
		16 05 485 B1.G102-0015.2 G1020015
		16 05 496 B1.G102-0015.2 G1020015
		16 05 504 B1.G102-0015.2 G1020015
		16 05 536 B1.G102-0015.2 G1020015
		16 05 544 B1.G102-0015.2 G1020015
		16 05 546 B1.G102-0015.2 G1020015
		16 05 562 B1.G102-0015.2 G1020015
		16 05 563 B1.G102-0015.2 G1020015
		16 05 582 B1.G102-0015.2 G1020015
		16 05 586 B1.G102-0015.2 G1020015
		16 05 624 B1.G120-1143.2 G1201143
		16 05 625 B1.G102-0610.2 G1020610
		16 05 668 B1.G102-0015.2 G1020015
		16 05 670 B1.G102-0015.2 G1020015
		16 05 671 B1.G102-0015.2 G1020015
		16 05 687 B1.G102-0271.2 G1020271
		16 05 696 B1.G102-0015.2 G1020015
		16 05 697 B1.G102-0015.2 G1020015
		16 05 703 B1.G102-0015.2 G1020015
		16 05 704 B1.G102-0015.2 G1020015
		16 05 728 B1.G102-0272.2 G1020272
		16 05 746 B1.G102-0258.2 G1020258
		16 05 783 B1.G102-0015.2 G1020015
		16 05 787 B1.G102-0015.2 G1020015
		16 05 788 B1.G102-0015.2 G1020015
		16 05 789 B1.G102-0258.2 G1020258
		16 05 791 B1.G102-0015.2 G1020015
		16 05 795 B1.G102-0015.2 G1020015
		16 05 799 B1.G102-0271.2 G1020271
		16 05 808 B1.G102-0258.2 G1020258
		16 05 810 B1.G102-0317.2 G1020317
		16 05 820 B1.G102-0015.2 G1020015
		16 05 824 B1.G102-0317.2 G1020317
		16 05 855 B1.G102-0369.2 G1020369
		16 05 870 B1.G102-0015.2 G1020015
		16 05 877 B1.G102-0272.2 G1020272
		16 05 879 B1.G102-0271.2 G1020271
		16 05 881 B1.G102-0317.2 G1020317
		16 05 883 B1.G102-0271.2 G1020271
		16 05 907 B1.G102-0317.2 G1020317
		16 05 911 B1.G102-0258.2 G1020258
		16 05 912 B1.G102-0403.2 G1020403
		16 05 924 B1.G102-0271.2 G1020271

# Cross reference list

Liste des correspondances / Tabella di conversione codici / Lista de comparação /

Lista porównawcza numerów / Porovnávací seznam čísel



OPEL		OPEL		PAGID				
16 05 957	B1.G102-0550.2	G1020550	5 69 022	B1.G212-0184.1	G2112184	50413	B1.G210-0202.1	G2110202
16 05 959	B1.G102-0542.2	G1020542	5 69 024	B1.G222-0231.1	G2122231	50424	B1.G222-0115.1	G2122115
16 05 961	B1.G102-0554.2	G1020554	5 69 030	B1.G213-0161.1	G2113161	50433	B1.G210-0211.1	G2110211
16 05 964	B1.G102-0545.2	G1020545	5 69 031	B1.G220-0115.1	G2120115	50436	B1.G219-0107.1	G2119107
16 05 965	B1.G102-0560.2	G1020560	5 69 042	B1.G224-0115.1	G2124115	50439	B1.G222-0159.1	G2122159
16 05 966	B1.G102-0403.2	G1020403	5 69 046	B1.G220-0140.1	G2120140	50448	B1.G222-0160.1	G2122160
16 05 967	B1.G102-0610.2	G1020610	5 69 054	B1.G220-0115.1	G2120115	50449	B1.G219-0108.1	G2119108
16 05 972	B1.G102-0650.2	G1020650	5 69 055	B1.G220-0140.1	G2120140	50608	B1.G208-0107.1	G2108107
16 05 973	B1.G102-0670.2	G1020670	5 69 056	B1.G225-0119.1	G2125119	50610	B1.G208-0106.1	G2108106
16 05 974	B1.G102-0545.2	G1020545	5 69 059	B1.G224-0152.1	G2124152	50910	B1.G212-0127.1	G2112127
16 05 976	B1.G102-0605.2	G1020605	5 69 060	B1.G225-0131.1	G2125131	50915	B1.G220-0142.1	G2120142
16 05 980	B1.G102-0624.2	G1020624	5 69 061	B1.G225-0142.1	G2125142	50916	B1.G224-0127.1	G2124127
16 05 982	B1.G102-0627.2	G1020627	5 69 065	B1.G222-0231.1	G2122231	50917	B1.G224-0138.1	G2124138
16 05 984	B1.G102-0642.2	G1020642	5 69 066	B1.G225-0131.1	G2125131	50936	B1.G220-0155.1	G2120155
16 05 992	B1.G102-0765.2	G1020765	5 69 067	B1.G225-0198.1	G2125198	51008	B1.G210-0115.1	G2110115
16 05 993	B1.G102-0670.2	G1020670	5 69 086	B1.G222-0145.1	G2122145	51012	B1.G210-0196.1	G2110196
16 05 994	B1.G102-0560.2	G1020560	5 69 108	B1.G210-0251.1	G2110251	51013	B1.G210-0213.1	G2110213
16 05 995	B1.G102-0610.2	G1020610	5 69 109	B1.G210-0250.1	G2110250	51023	B1.G220-0147.1	G2120147
16 05 996	B1.G102-0765.2	G1020765	5 69 111	B1.G210-0251.1	G2110251	51024	B1.G224-0131.1	G2124131
16 05 997	B1.G102-0765.2	G1020765	5 69 115	B1.G212-0157.1	G2112157	51026	B1.G224-0120.1	G2124120
16 05 998	B1.G102-0765.2	G1020765	5 69 208	B1.G212-0131.1	G2112131	51027	B1.G220-0146.1	G2120146
44 02 993	B1.G102-0624.2	G1020624	5 69 209	B1.G210-0225.1	G2110225	51032	B1.G224-0131.1	G2124131
44 03 045	B1.G212-0155.1	G2112155	6 05 135	B1.G102-0928.2	G1020928	51034	B1.G212-0141.1	G2112141
44 03 467	B1.G102-0627.2	G1020627				51040	B1.G222-0172.1	G2122172
44 04 585	B1.G102-0624.2	G1020624	<b>PAGID</b>			51106	B1.G210-0212.1	G2110212
44 08 275	B1.G228-0132.1	G2128132	50253	B1.G207-0109.1	G2107109	51119	B1.G221-0105.1	G2121105
44 14 021	B1.G102-0633.2	G1020633	50257	B1.G224-0158.1	G2124158	51803	B1.G210-0190.1	G2110190
44 14 029	B1.G102-0529.2	G1020529	50260	B1.G209-0136.1	G2109136	51804	B1.G210-0209.1	G2110209
44 14 519	B1.G102-0633.2	G1020633	50263	B1.G209-0124.1	G2109124	51808	B1.G222-0147.1	G2122147
44 14 520	B1.G102-0529.2	G1020529	50269	B1.G232-0115.1	G2132115	51809	B1.G222-0145.1	G2122145
44 14 632	B1.G228-0132.1	G2128132	50270	B1.G228-0125.1	G2128125	51811	B1.G222-0197.1	G2122197
44 19 950	B1.G102-0905.2	G1020905	50280	B1.G213-0195.1	G2113195	52105	B1.G209-0120.1	G2109120
44 20 066	B1.G102-0907.2	G1020907	50286	B1.G221-0106.1	G2121106	52106	B1.G209-0120.1	G2109120
47 04 578	B1.G102-0605.2	G1020605	50288	B1.G224-0171.1	G2124171	52137	B1.G225-0110.1	G2125110
47 06 748	B1.G102-0605.2	G1020605	50289	B1.G224-0158.1	G2124158	52139	B1.G210-0217.1	G2110217
47 06 835	B1.G102-0605.2	G1020605	50297	B1.G232-0114.1	G2132114	52143	B1.G222-0161.1	G2122161
47 08 239	B1.G120-1059.2	G1201059	50301	B1.G218-0131.1	G2118131	52153	B1.G209-0114.1	G2109114
47 08 241	B1.G220-0211.1	G2120211	50310	B1.G225-0137.1	G2125137	52154	B1.G212-0144.1	G2112144
47 11 040	B1.G120-1059.2	G1201059	50311	B1.G210-0261.1	G2110261	52311	B1.G210-0215.1	G2110215
48 08 861	B1.G102-0979.2	G1020979	50314	B1.G222-0151.1	G2122151	52315	B1.G212-0137.1	G2112137
48 17 764	B1.G102-0979.2	G1020979	50315	B1.G225-0113.1	G2125113	52404	B1.G213-0161.1	G2113161
48 19 239	B1.G102-0981.2	G1020981	50316	B1.G230-0113.1	G2130113	52412	B1.G212-0131.1	G2112131
5 42 027	B1.G120-1148.2	G1201148	50317	B1.G218-0137.1	G2118137	52413	B1.G220-0115.1	G2120115
5 42 039	B1.G102-0953.2	G1020953	50318	B1.G225-0138.1	G2125138	52415	B1.G224-0115.1	G2124115
5 42 040	B1.G102-0953.2	G1020953	50324	B1.G222-0204.1	G2122204	52417	B1.G220-0140.1	G2120140
5 42 115	B1.G102-0928.2	G1020928	50325	B1.G210-0271.1	G2110271	52426	B1.G225-0119.1	G2125119
5 42 125	B1.G120-1149.2	G1201149	50345	B1.G224-0161.1	G2124161	52427	B1.G210-0225.1	G2110225
5 69 000	B1.G224-0166.1	G2124166	50346	B1.G212-0154.1	G2112154	52430	B1.G224-0152.1	G2124152
5 69 001	B1.G224-0115.1	G2124115	50358	B1.G225-0142.1	G2125142	52431	B1.G225-0131.1	G2125131
5 69 003	B1.G225-0141.1	G2125141	50360	B1.G224-0166.1	G2124166	52432	B1.G210-0251.1	G2110251
5 69 005	B1.G228-0164.1	G2128164	50361	B1.G212-0155.1	G2112155	52433	B1.G210-0250.1	G2110250
5 69 006	B1.G225-0148.1	G2125148	50362	B1.G213-0161.1	G2113161	52505	B1.G210-0187.1	G2110187
5 69 007	B1.G225-0198.1	G2125198	50363	B1.G220-0174.1	G2120174	52511	B1.G220-0133.1	G2120133
5 69 013	B1.G213-0161.1	G2113161	50364	B1.G222-0194.1	G2122194	52512	B1.G220-0132.1	G2120132
5 69 020	B1.G211-0152.1	G2111152	50365	B1.G226-0120.1	G2126120	52514	B1.G210-0230.1	G2110230
5 69 020	B1.G213-0161.1	G2113161	50366	B1.G209-0137.1	G2109137	52515	B1.G213-0184.1	G2113184
5 69 021	B1.G220-0174.1	G2120174	50412	B1.G212-0126.1	G2112126	52516	B1.G213-0185.1	G2113185



# Cross reference list

Liste des correspondances / Tabella di conversione codici / Lista de comparação /



Lista porównawcza numerów / Porovnávací seznam čísel

PAGID		PAGID		PAGID				
52518	B1.G226-0106.1	G2126106	54187	B1.G225-0141.1	G2125141	54576	B1.G216-0123.1	G2116123
52803	B1.G212-0116.1	G2112116	54188	B1.G228-0164.1	G2128164	54592	B1.G228-0154.1	G2128154
52804	B1.G208-0104.1	G2108104	54189	B1.G224-0169.1	G2124169	54593	B1.G211-0145.1	G2111145
52816	B1.G208-0109.1	G2108109	54192	B1.G222-0216.1	G2122216	54601	B1.G212-0178.1	G2112178
52817	B1.G208-0109.1	G2108109	54198	B1.G228-0177.1	G2128177	54613	B1.G210-0312.1	G2110312
52818	B1.G208-0108.1	G2108108	54199	B1.G232-0144.1	G2132144	54616	B1.G226-0150.1	G2126150
52820	B1.G220-0125.1	G2120125	54202	B1.G232-0153.1	G2132153	54619	B1.G209-0142.1	G2109142
52830	B1.G221-0106.1	G2121106	54205	B1.G225-0158.1	G2125158	54642	B1.G222-0240.1	G2122240
52831	B1.G222-0148.1	G2122148	54206	B1.G230-0115.1	G2130115	54674	B1.G226-0154.1	G2126154
52833	B1.G224-0171.1	G2124171	54207	B1.G222-0210.1	G2122210	54675	B1.G209-0157.1	G2109157
53203	B1.G213-0182.1	G2113182	54208	B1.G225-0145.1	G2125145	54751	B1.G212-0171.1	G2112171
53634	B1.G225-0124.1	G2125124	54209	B1.G210-0277.1	G2110277	54969	B1.G228-0154.1	G2128154
53901	B1.G210-0151.1	G2110151	54210	B1.G225-0171.1	G2125171	55024	B1.G224-0222.1	G2124222
53908	B1.G212-0106.1	G2112106	54211	B1.G212-0158.1	G2112158	59432	B1.G228-0203.1	G2128203
53909	B1.G210-0178.1	G2110178	54212	B1.G230-0114.1	G2130114	50263PRO	B1.G209-0124.1	G2109124
53911	B1.G210-0111.1	G2110111	54214	B1.G222-0211.1	G2122211	50270PRO	B1.G228-0125.1	G2128125
53913	B1.G213-0178.1	G2113178	54222	B1.G234-0100.1	G2134100	50286PRO	B1.G221-0106.1	G2121106
53917	B1.G210-0261.1	G2110261	54246	B1.G225-0148.1	G2125148	50297PRO	B1.G232-0114.1	G2132114
53924	B1.G210-0201.1	G2110201	54249	B1.G211-0154.1	G2111154	50301PRO	B1.G218-0131.1	G2118131
53925	B1.G215-0105.1	G2115105	54256	B1.G210-0302.1	G2110302	50311PRO	B1.G210-0261.1	G2110261
53929	B1.G213-0181.1	G2113181	54257	B1.G210-0285.1	G2110285	50315PRO	B1.G225-0113.1	G2125113
53930	B1.G220-0123.1	G2120123	54258	B1.G225-0155.1	G2125155	50316PRO	B1.G230-0113.1	G2130113
53934	B1.G220-0128.1	G2120128	54259	B1.G225-0155.1	G2125155	50317PRO	B1.G218-0137.1	G2118137
53942	B1.G225-0105.1	G2125105	54262	B1.G209-0139.1	G2109139	50318PRO	B1.G225-0138.1	G2125138
53944	B1.G210-0210.1	G2110210	54293	B1.G225-0198.1	G2125198	50324PRO	B1.G222-0204.1	G2122204
53946	B1.G210-0232.1	G2110232	54296	B1.G212-0162.1	G2112162	50325PRO	B1.G210-0271.1	G2110271
53947	B1.G218-0106.1	G2118106	54303	B1.G225-0165.1	G2125165	50345PRO	B1.G224-0161.1	G2124161
53953	B1.G222-0151.1	G2122151	54304	B1.G225-0170.1	G2125170	50346PRO	B1.G212-0154.1	G2112154
53954	B1.G222-0150.1	G2122150	54305	B1.G211-0164.1	G2111164	50358PRO	B1.G225-0142.1	G2125142
53955	B1.G209-0123.1	G2109123	54315	B1.G222-0161.1	G2122161	50360PRO	B1.G224-0166.1	G2124166
53959	B1.G212-0138.1	G2112138	54319	B1.G222-0232.1	G2122232	50361PRO	B1.G212-0155.1	G2112155
53960	B1.G225-0113.1	G2125113	54321	B1.G208-0113.1	G2108113	50362PRO	B1.G211-0152.1	G2111152
53961	B1.G222-0152.1	G2122152	54322	B1.G225-0149.1	G2125149	50363PRO	B1.G220-0174.1	G2120174
53962	B1.G225-0115.1	G2125115	54323	B1.G230-0175.1	G2130175	50364PRO	B1.G222-0194.1	G2122194
53963	B1.G225-0114.1	G2125114	54324	B1.G230-0176.1	G2130176	50365PRO	B1.G226-0120.1	G2126120
53964	B1.G210-0223.1	G2110223	54328	B1.G222-0238.1	G2122238	50366PRO	B1.G209-0137.1	G2109137
53969	B1.G210-0258.1	G2110258	54330	B1.G220-0195.1	G2120195	50412PRO	B1.G212-0126.1	G2112126
53971	B1.G225-0123.1	G2125123	54334	B1.G220-0115.1	G2120115	50413PRO	B1.G210-0202.1	G2110202
53972	B1.G222-0163.1	G2122163	54337	B1.G211-0155.1	G2111155	50424PRO	B1.G222-0115.1	G2122115
54024	B1.G210-0229.1	G2110229	54338	B1.G211-0158.1	G2111158	50433PRO	B1.G210-0211.1	G2110211
54054	B1.G222-0161.1	G2122161	54377	B1.G224-0197.1	G2124197	50436PRO	B1.G219-0107.1	G2119107
54058	B1.G209-0133.1	G2109133	54389	B1.G225-0124.1	G2125124	50439PRO	B1.G222-0159.1	G2122159
54059	B1.G225-0110.1	G2125110	54398	B1.G225-0124.1	G2125124	50448PRO	B1.G222-0160.1	G2122160
54127	B1.G210-0229.1	G2110229	54408	B1.G212-0169.1	G2112169	50449PRO	B1.G219-0108.1	G2119108
54138	B1.G224-0171.1	G2124171	54412	B1.G225-0117.1	G2125117	50610PRO	B1.G208-0106.1	G2108106
54139	B1.G224-0158.1	G2124158	54413	B1.G225-0162.1	G2125162	50910PRO	B1.G212-0127.1	G2112127
54151	B1.G228-0176.1	G2128176	54419	B1.G220-0180.1	G2120180	50915PRO	B1.G220-0142.1	G2120142
54152	B1.G228-0176.1	G2128176	54457	B1.G222-0231.1	G2122231	50916PRO	B1.G224-0127.1	G2124127
54153	B1.G228-0142.1	G2128142	54471	B1.G218-0145.1	G2118145	50917PRO	B1.G224-0138.1	G2124138
54154	B1.G210-0278.1	G2110278	54472	B1.G210-0324.1	G2110324	51008PRO	B1.G210-0115.1	G2110115
54156	B1.G220-0175.1	G2120175	54489	B1.G220-0211.1	G2120211	51023PRO	B1.G220-0147.1	G2120147
54160	B1.G228-0132.1	G2128132	54495	B1.G224-0191.1	G2124191	51026PRO	B1.G224-0120.1	G2124120
54161	B1.G216-0124.1	G2116124	54537	B1.G228-0132.1	G2128132	51027PRO	B1.G220-0146.1	G2120146
54166	B1.G224-0127.1	G2124127	54540	B1.G208-0108.1	G2108108	51034PRO	B1.G212-0141.1	G2112141
54167	B1.G224-0138.1	G2124138	54541	B1.G208-0109.1	G2108109	51040PRO	B1.G222-0172.1	G2122172
54180	B1.G220-0184.1	G2120184	54549	B1.G220-0204.1	G2120204	51119PRO	B1.G221-0105.1	G2121105
54185	B1.G212-0157.1	G2112157	54574	B1.G216-0124.1	G2116124	51803PRO	B1.G210-0190.1	G2110190

# Cross reference list

Liste des correspondances / Tabella di conversione codici / Lista de comparação /

Lista porównawcza numerów / Porovnávací seznam čísel



PAGID		PAGID		PAGID	
51804PRO	B1.G210-0209.1	G2110209	54138PRO	B1.G224-0171.1	G2124171
51808PRO	B1.G222-0147.1	G2122147	54139PRO	B1.G224-0158.1	G2124158
51809PRO	B1.G222-0145.1	G2122145	54152PRO	B1.G228-0176.1	G2128176
51811PRO	B1.G222-0197.1	G2122197	54153PRO	B1.G228-0142.1	G2128142
52105PRO	B1.G209-0120.1	G2109120	54154PRO	B1.G210-0278.1	G2110278
52106PRO	B1.G209-0120.1	G2109120	54156PRO	B1.G220-0175.1	G2120175
52137PRO	B1.G225-0110.1	G2125110	54160PRO	B1.G228-0132.1	G2128132
52139PRO	B1.G210-0217.1	G2110217	54166PRO	B1.G224-0127.1	G2124127
52153PRO	B1.G209-0114.1	G2109114	54167PRO	B1.G224-0138.1	G2124138
52154PRO	B1.G212-0144.1	G2112144	54180PRO	B1.G220-0184.1	G2120184
52404PRO	B1.G213-0161.1	G2113161	54185PRO	B1.G212-0157.1	G2112157
52412PRO	B1.G212-0131.1	G2112131	54187PRO	B1.G225-0141.1	G2125141
52413PRO	B1.G220-0115.1	G2120115	54188PRO	B1.G228-0164.1	G2128164
52415PRO	B1.G224-0115.1	G2124115	54189PRO	B1.G224-0169.1	G2124169
52417PRO	B1.G220-0140.1	G2120140	54192PRO	B1.G222-0216.1	G2122216
52426PRO	B1.G225-0119.1	G2125119	54198PRO	B1.G228-0177.1	G2128177
52427PRO	B1.G210-0225.1	G2110225	54199PRO	B1.G232-0144.1	G2132144
52430PRO	B1.G224-0152.1	G2124152	54202PRO	B1.G232-0153.1	G2132153
52431PRO	B1.G225-0131.1	G2125131	54207PRO	B1.G222-0210.1	G2122210
52432PRO	B1.G210-0251.1	G2110251	54208PRO	B1.G225-0145.1	G2125145
52433PRO	B1.G210-0250.1	G2110250	54209PRO	B1.G210-0277.1	G2110277
52505PRO	B1.G210-0187.1	G2110187	54210PRO	B1.G225-0171.1	G2125171
52511PRO	B1.G220-0133.1	G2120133	54211PRO	B1.G212-0158.1	G2112158
52512PRO	B1.G220-0132.1	G2120132	54212PRO	B1.G230-0114.1	G2130114
52514PRO	B1.G210-0230.1	G2110230	54214PRO	B1.G222-0211.1	G2122211
52515PRO	B1.G213-0184.1	G2113184	54222PRO	B1.G234-0100.1	G2134100
52516PRO	B1.G213-0185.1	G2113185	54246PRO	B1.G225-0148.1	G2125148
52518PRO	B1.G226-0106.1	G2126106	54256PRO	B1.G210-0302.1	G2110302
52803PRO	B1.G212-0116.1	G2112116	54257PRO	B1.G210-0285.1	G2110285
52804PRO	B1.G208-0104.1	G2108104	54259PRO	B1.G225-0155.1	G2125155
52820PRO	B1.G220-0125.1	G2120125	54262PRO	B1.G209-0139.1	G2109139
52831PRO	B1.G222-0148.1	G2122148	54293PRO	B1.G225-0198.1	G2125198
53901PRO	B1.G210-0151.1	G2110151	54296PRO	B1.G212-0162.1	G2112162
53908PRO	B1.G212-0106.1	G2112106	54303PRO	B1.G225-0165.1	G2125165
53911PRO	B1.G210-0111.1	G2110111	54315PRO	B1.G222-0161.1	G2122161
53913PRO	B1.G213-0178.1	G2113178	54319PRO	B1.G222-0232.1	G2122232
53924PRO	B1.G210-0201.1	G2110201	54321PRO	B1.G208-0113.1	G2108113
53925PRO	B1.G215-0105.1	G2115105	54322PRO	B1.G225-0149.1	G2125149
53929PRO	B1.G213-0181.1	G2113181	54323PRO	B1.G230-0175.1	G2130175
53930PRO	B1.G220-0123.1	G2120123	54324PRO	B1.G230-0176.1	G2130176
53934PRO	B1.G220-0128.1	G2120128	54328PRO	B1.G222-0238.1	G2122238
53942PRO	B1.G225-0115.1	G2125115	54337PRO	B1.G211-0155.1	G2111155
53944PRO	B1.G210-0210.1	G2110210	54338PRO	B1.G211-0158.1	G2111158
53946PRO	B1.G210-0232.1	G2110232	54377PRO	B1.G224-0197.1	G2124197
53947PRO	B1.G218-0106.1	G2118106	54408PRO	B1.G212-0169.1	G2112169
53953PRO	B1.G222-0151.1	G2122151	54419PRO	B1.G220-0180.1	G2120180
53954PRO	B1.G222-0150.1	G2122150	54457PRO	B1.G222-0231.1	G2122231
53959PRO	B1.G212-0138.1	G2112138	54489PRO	B1.G220-0211.1	G2120211
53961PRO	B1.G222-0152.1	G2122152	54495PRO	B1.G224-0191.1	G2124191
53962PRO	B1.G225-0115.1	G2125115	54549PRO	B1.G220-0204.1	G2120204
53963PRO	B1.G225-0114.1	G2125114	54599PRO	B1.G225-0184.1	G2125184
53964PRO	B1.G210-0223.1	G2110223	54601PRO	B1.G212-0178.1	G2112178
53971PRO	B1.G225-0123.1	G2125123	54646PRO	B1.G212-0184.1	G2112184
53972PRO	B1.G222-0163.1	G2122163	54750PRO	B1.G210-0271.1	G2110271
54024PRO	B1.G210-0229.1	G2110229	54751PRO	B1.G212-0171.1	G2112171
54058PRO	B1.G209-0133.1	G2109133	54760PRO	B1.G223-0113.1	G2123113
54059PRO	B1.G225-0110.1	G2125110	54795PRO	B1.G222-0258.1	G2122258
54955PRO	B1.G224-0221.1	G2124221			
55249PRO	B1.G210-0356.1	G2110356			
55367PRO	B1.G212-0127.1	G2112127			
55377PRO	B1.G225-0199.1	G2125199			
C3016	B1.G102-0766.2	G1020766			
C3016	B1.G102-0922.2	G1020922			
C4028	B1.G102-0891.2	G1020891			
C4030	B1.G102-0357.2	G1020357			
C4068	B1.G102-0891.2	G1020891			
C6023	B1.G102-0828.2	G1020828			
C6024	B1.G102-0769.2	G1020769			
C6026	B1.G102-0770.2	G1020770			
C6027	B1.G102-0940.2	G1020940			
C6029	B1.G102-0825.2	G1020825			
T0221	B1.G102-0140.2	G1020140			
T0221-ECO	B1.G102-0140.2	G1020140			
T0229NA	B1.G102-0257.2	G1020257			
T0262NA	B1.G102-0246.2	G1020246			
T0290	B1.G102-0147.2	G1020147			
T0302NA	B1.G102-0197.2	G1020197			
T0351	B1.G102-0009.2	G1020009			
T0352	B1.G102-0257.2	G1020257			
T0352-ECO	B1.G102-0257.2	G1020257			
T0353	B1.G102-0184.2	G1020184			
T0353-ECO	B1.G102-0184.2	G1020184			
T0375	B1.G102-0015.2	G1020015			
T0375-ECO	B1.G102-0015.2	G1020015			
T0388	B1.G102-0344.2	G1020344			
T0388-ECO	B1.G102-0344.2	G1020344			
T0389	B1.G102-0617.2	G1020617			
T0390	B1.G102-0618.2	G1020618			
T0449	B1.G102-0097.2	G1020097			
T0449-ECO	B1.G102-0097.2	G1020097			
T0624	B1.G102-0141.2	G1020141			
T0624-ECO	B1.G102-0141.2	G1020141			
T0671	B1.G102-0065.2	G1020065			
T0697	B1.G102-0065.2	G1020065			
T0841	B1.G102-0015.2	G1020015			
T0841-ECO	B1.G102-0015.2	G1020015			
T0841-NA2	B1.G102-0015.2	G1020015			
T1004	B1.G102-0022.2	G1020022			
T1004-ECO	B1.G102-0022.2	G1020022			
T1005	B1.G102-0026.2	G1020026			
T1010	B1.G102-0046.2	G1020046			
T1010-ECO	B1.G102-0046.2	G1020046			
T1014	B1.G102-0339.2	G1020339			
T1014-ECO	B1.G102-0339.2	G1020339			
T1016	B1.G102-0271.2	G1020271			
T1016-ECO	B1.G102-0271.2	G1020271			
T1018	B1.G102-0308.2	G1020308			
T1021	B1.G102-0258.2	G1020258			
T1022	B1.G102-0332.2	G1020332			
T1022-ECO	B1.G102-0332.2	G1020332			
T1026	B1.G102-0474.2	G1020474			
T1026-ECO	B1.G102-0474.2	G1020474			
T1027	B1.G102-0308.2	G1020308			
T1027-ECO	B1.G102-0308.2	G1020308			



# Cross reference list

Liste des correspondances / Tabella di conversione codici / Lista de comparação /



Lista porównawcza numerów / Porovnávací seznam čísel

PAGID		PAGID		PAGID	
T1034	B1.G102-0272.2 G1020272	T1135	B1.G102-0683.2 G1020683	T1214	B1.G102-0548.2 G1020548
T1034-ECO	B1.G102-0272.2 G1020272	T1136	B1.G102-0368.2 G1020368	T1215	B1.G102-0470.2 G1020470
T1035	B1.G102-0311.2 G1020311	T1137	B1.G102-0293.2 G1020293	T1216	B1.G102-0448.2 G1020448
T1037	B1.G102-0608.2 G1020608	T1138	B1.G102-0443.2 G1020443	T1218	B1.G102-0644.2 G1020644
T1037-ECO	B1.G102-0608.2 G1020608	T1141	B1.G102-0334.2 G1020334	T1220	B1.G102-0646.2 G1020646
T1038	B1.G102-0373.2 G1020373	T1141-ECO	B1.G102-0334.2 G1020334	T1221	B1.G102-0648.2 G1020648
T1039	B1.G102-0316.2 G1020316	T1142	B1.G102-0396.2 G1020396	T1223	B1.G102-0754.2 G1020754
T1045	B1.G102-0317.2 G1020317	T1143	B1.G102-0390.2 G1020390	T1224	B1.G102-0678.2 G1020678
T1045-ECO	B1.G102-0317.2 G1020317	T1143-ECO	B1.G102-0390.2 G1020390	T1225	B1.G102-0765.2 G1020765
T1050	B1.G102-0400.2 G1020400	T1145	B1.G102-0550.2 G1020550	T1226	B1.G102-0469.2 G1020469
T1050-ECO	B1.G102-0400.2 G1020400	T1148	B1.G102-0389.2 G1020389	T1230	B1.G102-0634.2 G1020634
T1061	B1.G102-0265.2 G1020265	T1149	B1.G102-0313.2 G1020313	T1231	B1.G102-0882.2 G1020882
T1062	B1.G102-0320.2 G1020320	T1150	B1.G102-0392.2 G1020392	T1234	B1.G102-0650.2 G1020650
T1065	B1.G102-0219.2 G1020219	T1150	B1.G102-0500.2 G1020500	T1236	B1.G102-0687.2 G1020687
T1065	B1.G102-0323.2 G1020323	T1151	B1.G102-0351.2 G1020351	T1237	B1.G102-0637.2 G1020637
T1075	B1.G102-0292.2 G1020292	T1152	B1.G102-0442.2 G1020442	T1240	B1.G102-0568.2 G1020568
T1078	B1.G102-0956.2 G1020956	T1153	B1.G102-0441.2 G1020441	T1246	B1.G102-0627.2 G1020627
T1079	B1.G102-0369.2 G1020369	T1154	B1.G102-0512.2 G1020512	T1247	B1.G102-0756.2 G1020756
T1081	B1.G102-0265.2 G1020265	T1163	B1.G102-0463.2 G1020463	T1248	B1.G102-0885.2 G1020885
T1082	B1.G102-0258.2 G1020258	T1163-ECO	B1.G102-0463.2 G1020463	T1249	B1.G102-0886.2 G1020886
T1082-ECO	B1.G102-0258.2 G1020258	T1164	B1.G102-0542.2 G1020542	T1252	B1.G102-0608.2 G1020608
T1085	B1.G102-0403.2 G1020403	T1165	B1.G102-0331.2 G1020331	T1260	B1.G102-0567.2 G1020567
T1089	B1.G102-0291.2 G1020291	T1165-ECO	B1.G102-0331.2 G1020331	T1261	B1.G102-0692.2 G1020692
T1090	B1.G102-0269.2 G1020269	T1167	B1.G102-0505.2 G1020505	T1274	B1.G120-5241.2 G1205241
T1090	B1.G102-0275.2 G1020275	T1167-ECO	B1.G102-0505.2 G1020505	T1276	B1.G120-5230.2 G1205230
T1091	B1.G102-0398.2 G1020398	T1168	B1.G102-0582.2 G1020582	T1280	B1.G120-5344.2 G1205344
T1091-ECO	B1.G102-0398.2 G1020398	T1169	B1.G102-0584.2 G1020584	T1283	B1.G102-0901.2 G1020901
T1092	B1.G102-0401.2 G1020401	T1170	B1.G102-0583.2 G1020583	T1287	B1.G102-0409.2 G1020409
T1092	B1.G102-0776.2 G1020776	T1174	B1.G102-0574.2 G1020574	T1291	B1.G102-0785.2 G1020785
T1092-ECO	B1.G102-0401.2 G1020401	T1176	B1.G102-0540.2 G1020540	T1293	B1.G102-0638.2 G1020638
T1093	B1.G102-0312.2 G1020312	T1177	B1.G102-0608.2 G1020608	T1295	B1.G102-0513.2 G1020513
T1093-ECO	B1.G102-0312.2 G1020312	T1177-ECO	B1.G102-0608.2 G1020608	T1310	B1.G102-0624.2 G1020624
T1094	B1.G102-0408.2 G1020408	T1178	B1.G102-0316.2 G1020316	T1314	B1.G120-5238.2 G1205238
T1094-ECO	B1.G102-0408.2 G1020408	T1179	B1.G102-0527.2 G1020527	T1318	B1.G102-0677.2 G1020677
T1095	B1.G102-0342.2 G1020342	T1184	B1.G102-0510.2 G1020510	T1324	B1.G102-0686.2 G1020686
T1097	B1.G102-0355.2 G1020355	T1185	B1.G102-0427.2 G1020427	T1325	B1.G102-0574.2 G1020574
T1097-ECO	B1.G102-0355.2 G1020355	T1188	B1.G102-0575.2 G1020575	T1326	B1.G102-0484.2 G1020484
T1098	B1.G102-0340.2 G1020340	T1189	B1.G102-0578.2 G1020578	T1331	B1.G120-5418.2 G1205418
T1099	B1.G102-0360.2 G1020360	T1190	B1.G102-0480.2 G1020480	T1345	B1.G102-0496.2 G1020496
T1101	B1.G102-0331.2 G1020331	T1191	B1.G102-0271.2 G1020271	T1347	B1.G102-0440.2 G1020440
T1103	B1.G102-0411.2 G1020411	T1192	B1.G102-0467.2 G1020467	T1348	B1.G102-0829.2 G1020829
T1104	B1.G102-0415.2 G1020415	T1193	B1.G102-0519.2 G1020519	T1350	B1.G102-0753.2 G1020753
T1106	B1.G102-0312.2 G1020312	T1194	B1.G102-0557.2 G1020557	T1354	B1.G102-0516.2 G1020516
T1106-ECO	B1.G102-0312.2 G1020312	T1195	B1.G102-0580.2 G1020580	T1355	B1.G102-0517.2 G1020517
T1107	B1.G102-0419.2 G1020419	T1196	B1.G102-0534.2 G1020534	T1356	B1.G102-0518.2 G1020518
T1107-ECO	B1.G102-0419.2 G1020419	T1196-ECO	B1.G102-0534.2 G1020534	T1359	B1.G120-5242.2 G1205242
T1110	B1.G102-0379.2 G1020379	T1198	B1.G102-0441.2 G1020441	T1366	B1.G102-0588.2 G1020588
T1111	B1.G102-0742.2 G1020742	T1202	B1.G102-0591.2 G1020591	T1368	B1.G120-5333.2 G1205333
T1112	B1.G102-0642.2 G1020642	T1203	B1.G102-0642.2 G1020642	T1369	B1.G102-0514.2 G1020514
T1113	B1.G102-0332.2 G1020332	T1206	B1.G102-0271.2 G1020271	T1373	B1.G102-0685.2 G1020685
T1113-ECO	B1.G102-0332.2 G1020332	T1207	B1.G102-0316.2 G1020316	T1376	B1.G102-0680.2 G1020680
T1117	B1.G102-0367.2 G1020367	T1208	B1.G102-0360.2 G1020360	T1377	B1.G102-0682.2 G1020682
T1120	B1.G102-0367.2 G1020367	T1208	B1.G102-0473.2 G1020473	T1377	B1.G102-0734.2 G1020734
T1122	B1.G102-0642.2 G1020642	T1210	B1.G102-0562.2 G1020562	T1378	B1.G120-1002.2 G1201002
T1123	B1.G102-0290.2 G1020290	T1211	B1.G102-0563.2 G1020563	T1380	B1.G102-0593.2 G1020593
T1124	B1.G102-0397.2 G1020397	T1212	B1.G102-0576.2 G1020576	T1381	B1.G120-5366.2 G1205366
T1125	B1.G102-0395.2 G1020395	T1213	B1.G102-0547.2 G1020547	T1382	B1.G102-0751.2 G1020751

# Cross reference list

Liste des correspondances / Tabella di conversione codici / Lista de comparação /



Lista porównawcza numerów / Porovnávací seznam čísel

PAGID		PAGID		PAGID	
T1383	B1.G102-0752.2 G1020752	T1499	B1.G120-1010.2 G1201010	T1642	B1.G102-0802.2 G1020802
T1387	B1.G102-0411.2 G1020411	T1500	B1.G120-1011.2 G1201011	T1647	B1.G102-0858.2 G1020858
T1388	B1.G102-0313.2 G1020313	T1516	B1.G102-0860.2 G1020860	T1648	B1.G102-0737.2 G1020737
T1389	B1.G102-0638.2 G1020638	T1528	B1.G102-0692.2 G1020692	T1649	B1.G102-0896.2 G1020896
T1390	B1.G102-0529.2 G1020529	T1530	B1.G102-0544.2 G1020544	T1650	B1.G102-0896.2 G1020896
T1392	B1.G102-0566.2 G1020566	T1530	B1.G102-0852.2 G1020852	T1653	B1.G102-0889.2 G1020889
T1393	B1.G102-0478.2 G1020478	T1531	B1.G102-0830.2 G1020830	T1655	B1.G102-0730.2 G1020730
T1397	B1.G102-0812.2 G1020812	T1534	B1.G102-0625.2 G1020625	T1656	B1.G102-0764.2 G1020764
T1398	B1.G102-0713.2 G1020713	T1536	B1.G102-0885.2 G1020885	T1656	B1.G102-0873.2 G1020873
T1399	B1.G102-0538.2 G1020538	T1537	B1.G102-0886.2 G1020886	T1657	B1.G102-0763.2 G1020763
T1399	B1.G102-0741.2 G1020741	T1538	B1.G102-0563.2 G1020563	T1657	B1.G102-0872.2 G1020872
T1401	B1.G120-1025.2 G1201025	T1547	B1.G102-0772.2 G1020772	T1658	B1.G102-0787.2 G1020787
T1410	B1.G102-0758.2 G1020758	T1549	B1.G102-0659.2 G1020659	T1658	B1.G102-0900.2 G1020900
T1410	B1.G102-0759.2 G1020759	T1550	B1.G102-0746.2 G1020746	T1659	B1.G102-0981.2 G1020981
T1414	B1.G120-1066.2 G1201066	T1551	B1.G102-0756.2 G1020756	T1663	B1.G120-1148.2 G1201148
T1416	B1.G102-0678.2 G1020678	T1552	B1.G120-1047.2 G1201047	T1663	B1.G120-1149.2 G1201149
T1421	B1.G120-5234.2 G1205234	T1563	B1.G102-0367.2 G1020367	T1664	B1.G120-1009.2 G1201009
T1424	B1.G102-0633.2 G1020633	T1564	B1.G102-0779.2 G1020779	T1668	B1.G120-1145.2 G1201145
T1428	B1.G102-0721.2 G1020721	T1565	B1.G102-0537.2 G1020537	T1669	B1.G120-1143.2 G1201143
T1429	B1.G102-0719.2 G1020719	T1566	B1.G102-0798.2 G1020798	T1670	B1.G120-1147.2 G1201147
T1432	B1.G102-0707.2 G1020707	T1568	B1.G102-0572.2 G1020572	T1676	B1.G102-0979.2 G1020979
T1436	B1.G102-0622.2 G1020622	T1569	B1.G120-1014.2 G1201014	T1679	B1.G120-1029.2 G1201029
T1440	B1.G102-0573.2 G1020573	T1577	B1.G102-0489.2 G1020489	T1687	B1.G120-1053.2 G1201053
T1441	B1.G102-0573.2 G1020573	T1579	B1.G102-0578.2 G1020578	T1690	B1.G102-0867.2 G1020867
T1442	B1.G102-0613.2 G1020613	T1580	B1.G120-1065.2 G1201065	T1693	B1.G102-0871.2 G1020871
T1444	B1.G102-0794.2 G1020794	T1581	B1.G102-0994.2 G1020994	T1696	B1.G102-0786.2 G1020786
T1445	B1.G102-0844.2 G1020844	T1582	B1.G120-1022.2 G1201022	T1696	B1.G120-1135.2 G1201135
T1446	B1.G102-0846.2 G1020846	T1585	B1.G102-0701.2 G1020701	T1699	B1.G102-0734.2 G1020734
T1447	B1.G102-0850.2 G1020850	T1586	B1.G120-1013.2 G1201013	T1699	B1.G102-0993.2 G1020993
T1448	B1.G102-0586.2 G1020586	T1591	B1.G120-1033.2 G1201033	T1701	B1.G102-0790.2 G1020790
T1448	B1.G102-0848.2 G1020848	T1592	B1.G120-1035.2 G1201035	T1702	B1.G102-0792.2 G1020792
T1449	B1.G102-0614.2 G1020614	T1594	B1.G120-1059.2 G1201059	T1703	B1.G102-0799.2 G1020799
T1450	B1.G102-0648.2 G1020648	T1596	B1.G102-0971.2 G1020971	T1704	B1.G102-0833.2 G1020833
T1451	B1.G102-0610.2 G1020610	T1598	B1.G102-0856.2 G1020856	T1708	B1.G102-0937.2 G1020937
T1452	B1.G102-0661.2 G1020661	T1600	B1.G120-1085.2 G1201085	T1710	B1.G102-0938.2 G1020938
T1453	B1.G102-0855.2 G1020855	T1601	B1.G102-0974.2 G1020974	T1716	B1.G102-0666.2 G1020666
T1454	B1.G102-0877.2 G1020877	T1606	B1.G102-0672.2 G1020672	T1719	B1.G120-5241.2 G1205241
T1455	B1.G102-0862.2 G1020862	T1607	B1.G102-0672.2 G1020672	T1726	B1.G102-0988.2 G1020988
T1457	B1.G102-0706.2 G1020706	T1609	B1.G102-0698.2 G1020698	T1727	B1.G102-0768.2 G1020768
T1460	B1.G102-0711.2 G1020711	T1609	B1.G102-0699.2 G1020699	T1728	B1.G102-0975.2 G1020975
T1461	B1.G102-0761.2 G1020761	T1616	B1.G102-0774.2 G1020774	T1729	B1.G102-0819.2 G1020819
T1462	B1.G102-0762.2 G1020762	T1619	B1.G102-0806.2 G1020806	T1731	B1.G102-0817.2 G1020817
T1463	B1.G102-0660.2 G1020660	T1622	B1.G102-0933.2 G1020933	T1736	B1.G120-1004.2 G1201004
T1469	B1.G102-0691.2 G1020691	T1622	B1.G102-0934.2 G1020934	T1736	B1.G120-1005.2 G1201005
T1473	B1.G102-0694.2 G1020694	T1623	B1.G102-0933.2 G1020933	T1738	B1.G102-0796.2 G1020796
T1478	B1.G102-0704.2 G1020704	T1623	B1.G102-0934.2 G1020934	T1746	B1.G102-0893.2 G1020893
T1482	B1.G102-0500.2 G1020500	T1624	B1.G102-0935.2 G1020935	T1746	B1.G120-1073.2 G1201073
T1486	B1.G102-0605.2 G1020605	T1626	B1.G120-1079.2 G1201079	T1748	B1.G102-0983.2 G1020983
T1487	B1.G102-0754.2 G1020754	T1627	B1.G102-0999.2 G1020999	T1751	B1.G102-0866.2 G1020866
T1488	B1.G102-0696.2 G1020696	T1629	B1.G102-0501.2 G1020501	T1754	B1.G102-0706.2 G1020706
T1489	B1.G102-0670.2 G1020670	T1631	B1.G102-0650.2 G1020650	T1755	B1.G102-0707.2 G1020707
T1489	B1.G102-0727.2 G1020727	T1634	B1.G102-0497.2 G1020497	T1758	B1.G102-0699.2 G1020699
T1492	B1.G102-0682.2 G1020682	T1637	B1.G102-0963.2 G1020963	T1759	B1.G102-0630.2 G1020630
T1492	B1.G102-0734.2 G1020734	T1638	B1.G102-0933.2 G1020933	T1759	B1.G102-0995.2 G1020995
T1494	B1.G102-0887.2 G1020887	T1638	B1.G102-0934.2 G1020934	T1760	B1.G102-0823.2 G1020823
T1495	B1.G102-0745.2 G1020745	T1640	B1.G102-0801.2 G1020801	T1764	B1.G102-0974.2 G1020974
T1496	B1.G102-0630.2 G1020630	T1641	B1.G102-0800.2 G1020800	T1766	B1.G102-0859.2 G1020859

# Cross reference list

Liste des correspondances / Tabella di conversione codici / Lista de comparação /



Lista porównawcza numerów / Porovnávací seznam čísel

PAGID		PAGID		PAGID	
T1770	B1.G102-0939.2 G1020939	T2056	B1.G120-1079.2 G1201079	T5056-ECO	B1.G102-0246.2 G1020246
T1771	B1.G102-0803.2 G1020803	T2080	B1.G102-0758.2 G1020758	T5061	B1.G102-0955.2 G1020955
T1773	B1.G102-0875.2 G1020875	T2080	B1.G102-0759.2 G1020759	T5066	B1.G102-0315.2 G1020315
T1773	B1.G102-0876.2 G1020876	T2083	B1.G102-0877.2 G1020877	T5067	B1.G102-0337.2 G1020337
T1774	B1.G102-0874.2 G1020874	T2084	B1.G102-0895.2 G1020895	T5067-ECO	B1.G102-0337.2 G1020337
T1775	B1.G102-0834.2 G1020834	T2087	B1.G120-1059.2 G1201059	T5072	B1.G102-0347.2 G1020347
T1778	B1.G120-1053.2 G1201053	T2094	B1.G102-0856.2 G1020856	T5072-ECO	B1.G102-0347.2 G1020347
T1783	B1.G102-0992.2 G1020992	T2097	B1.G120-1224.2 G1201224	T5074	B1.G102-0299.2 G1020299
T1788	B1.G102-0921.2 G1020921	T2108	B1.G102-0567.2 G1020567	T5075	B1.G102-0345.2 G1020345
T1791	B1.G102-0785.2 G1020785	T2138	B1.G120-1035.2 G1201035	T5075	B1.G102-0492.2 G1020492
T1795	B1.G120-5333.2 G1205333	T2145	B1.G102-0761.2 G1020761	T5075	B1.G102-0549.2 G1020549
T1796	B1.G120-5241.2 G1205241	T2198	B1.G102-0889.2 G1020889	T5075	B1.G102-0920.2 G1020920
T1798	B1.G120-1079.2 G1201079	T2201	B1.G102-0764.2 G1020764	T5077	B1.G102-0501.2 G1020501
T1813	B1.G102-0776.2 G1020776	T2207	B1.G120-1128.2 G1201128	T5077-ECO	B1.G102-0501.2 G1020501
T1824	B1.G102-0397.2 G1020397	T2211	B1.G102-0489.2 G1020489	T5078	B1.G102-0301.2 G1020301
T1825	B1.G102-0738.2 G1020738	T2211	B1.G102-0920.2 G1020920	T5079	B1.G102-0302.2 G1020302
T1826	B1.G102-0396.2 G1020396	T2216	B1.G102-0951.2 G1020951	T5084	B1.G102-0310.2 G1020310
T1827	B1.G102-0794.2 G1020794	T3018	B1.G102-0722.2 G1020722	T5089	B1.G102-0658.2 G1020658
T1832	B1.G102-0952.2 G1020952	T3040	B1.G102-0457.2 G1020457	T5090	B1.G102-0362.2 G1020362
T1835	B1.G102-0742.2 G1020742	T3040	B1.G102-0779.2 G1020779	T5091	B1.G102-0372.2 G1020372
T1841	B1.G102-0680.2 G1020680	T3052	B1.G102-0721.2 G1020721	T5092	B1.G102-0363.2 G1020363
T1844	B1.G102-0946.2 G1020946	T3058	B1.G120-1056.2 G1201056	T5095	B1.G102-0444.2 G1020444
T1851	B1.G102-0834.2 G1020834	T3064	B1.G120-5404.2 G1205404	T5095-ECO	B1.G102-0444.2 G1020444
T1852	B1.G102-0714.2 G1020714	T3095	B1.G102-0537.2 G1020537	T5098	B1.G102-0421.2 G1020421
T1858	B1.G120-1213.2 G1201213	T3099	B1.G102-0714.2 G1020714	T5098-ECO	B1.G102-0421.2 G1020421
T1863	B1.G102-0999.2 G1020999	T3120	B1.G102-0712.2 G1020712	T5099	B1.G102-0451.2 G1020451
T1894	B1.G120-1126.2 G1201126	T3121	B1.G102-0605.2 G1020605	T5100	B1.G102-0458.2 G1020458
T1906	B1.G120-1209.2 G1201209	T3129	B1.G102-0662.2 G1020662	T5100	B1.G102-0780.2 G1020780
T1907	B1.G120-1047.2 G1201047	T3130	B1.G102-0663.2 G1020663	T5101	B1.G102-0440.2 G1020440
T1908	B1.G120-1035.2 G1201035	T3132	B1.G120-1010.2 G1201010	T5101	B1.G120-1272.2 G1201272
T1909	B1.G120-1033.2 G1201033	T4017	B1.G102-0334.2 G1020334	T5102	B1.G102-0359.2 G1020359
T1914	B1.G120-5352.2 G1205352	T4017-ECO	B1.G102-0334.2 G1020334	T5110	B1.G102-0440.2 G1020440
T1921	B1.G102-0975.2 G1020975	T4150	B1.G102-0025.2 G1020025	T5110	B1.G120-1272.2 G1201272
T1926	B1.G102-0586.2 G1020586	T4150-ECO	B1.G102-0025.2 G1020025	T5111	B1.G102-0924.2 G1020924
T1956	B1.G102-0953.2 G1020953	T4151	B1.G102-0010.2 G1020010	T5111	B1.G102-0925.2 G1020925
T1957	B1.G102-0953.2 G1020953	T4151-ECO	B1.G102-0010.2 G1020010	T5112	B1.G102-0924.2 G1020924
T1959	B1.G102-0928.2 G1020928	T4154	B1.G102-0009.2 G1020009	T5112	B1.G102-0925.2 G1020925
T1969	B1.G102-0905.2 G1020905	T4154-ECO	B1.G102-0009.2 G1020009	T5114	B1.G102-0384.2 G1020384
T1970	B1.G102-0907.2 G1020907	T5005	B1.G102-0044.2 G1020044	T5115	B1.G102-0315.2 G1020315
T1989	B1.G102-0634.2 G1020634	T5005-ECO	B1.G102-0044.2 G1020044	T5115-ECO	B1.G102-0315.2 G1020315
T2003	B1.G102-0737.2 G1020737	T5006	B1.G102-0028.2 G1020028	T5118	B1.G102-0507.2 G1020507
T2003	B1.G102-0740.2 G1020740	T5006-ECO	B1.G102-0028.2 G1020028	T5122	B1.G102-0511.2 G1020511
T2003	B1.G120-1224.2 G1201224	T5009	B1.G102-0197.2 G1020197	T5122-ECO	B1.G102-0511.2 G1020511
T2006	B1.G102-0213.2 G1020213	T5009-ECO	B1.G102-0197.2 G1020197	T5123	B1.G102-0882.2 G1020882
T2006	B1.G102-0299.2 G1020299	T5021	B1.G102-0196.2 G1020196	T5125	B1.G102-0883.2 G1020883
T2006-ECO	B1.G102-0213.2 G1020213	T5021-ECO	B1.G102-0196.2 G1020196	T5128	B1.G102-0545.2 G1020545
T2006-ECO	B1.G102-0299.2 G1020299	T5022	B1.G102-0201.2 G1020201	T5129	B1.G102-0533.2 G1020533
T2013	B1.G102-0792.2 G1020792	T5022	B1.G102-0489.2 G1020489	T5130	B1.G102-0544.2 G1020544
T2027	B1.G102-0844.2 G1020844	T5025	B1.G102-0140.2 G1020140	T5131	B1.G102-0570.2 G1020570
T2029	B1.G102-0939.2 G1020939	T5025	B1.G102-0236.2 G1020236	T5134	B1.G102-0658.2 G1020658
T2029	B1.G102-0971.2 G1020971	T5048	B1.G102-0304.2 G1020304	T5135	B1.G102-0654.2 G1020654
T2031	B1.G102-0762.2 G1020762	T5048-ECO	B1.G102-0304.2 G1020304	T5137	B1.G102-0658.2 G1020658
T2041	B1.G120-1070.2 G1201070	T5050	B1.G102-0273.2 G1020273	T5138	B1.G102-0564.2 G1020564
T2048	B1.G120-1069.2 G1201069	T5050-ECO	B1.G102-0273.2 G1020273	T5140	B1.G102-0524.2 G1020524
T2050	B1.G102-0727.2 G1020727	T5051	B1.G102-0274.2 G1020274	T5143	B1.G102-0560.2 G1020560
T2054	B1.G102-0738.2 G1020738	T5051-ECO	B1.G102-0274.2 G1020274	T5144	B1.G120-5215.2 G1205215
T2054	B1.G120-1225.2 G1201225	T5056	B1.G102-0246.2 G1020246	T5145	B1.G120-5203.2 G1205203

# Cross reference list

Liste des correspondances / Tabella di conversione codici / Lista de comparação /

Lista porównawcza numerów / Porovnávací seznam čísel



<b>PAGID</b> 		<b>PAGID</b> 		<b>PEUGEOT</b> 	
T5146	B1.G102-0745.2 G1020745	T9100	B1.G102-0618.2 G1020618	4249 90	B1.G209-0137.1 G2109137
T5148	B1.G102-0710.2 G1020710	T9101	B1.G102-0569.2 G1020569	4249 94	B1.G220-0180.1 G2120180
T5149	B1.G102-0709.2 G1020709	T9103	B1.G102-0602.2 G1020602	4249 95	B1.G210-0187.1 G2110187
T5150	B1.G102-0711.2 G1020711	T9104	B1.G102-0603.2 G1020603	4249 96	B1.G220-0132.1 G2120132
T5154	B1.G102-0632.2 G1020632	T9106	B1.G102-0604.2 G1020604	4249 99	B1.G224-0127.1 G2124127
T5155	B1.G102-0652.2 G1020652	T9107	B1.G102-0595.2 G1020595	4249 A5	B1.G213-0185.1 G2113185
T5157	B1.G102-0572.2 G1020572			4249 C1	B1.G212-0162.1 G2112162
T5158	B1.G102-0610.2 G1020610	<b>PEUGEOT</b>		4249 F0	B1.G220-0133.1 G2120133
T5159	B1.G102-0483.2 G1020483	16 070 832 80	B1.G102-0920.2 G1020920	4249 F5	B1.G208-0106.1 G2108106
T5160	B1.G102-0732.2 G1020732	16 076 903 80	B1.G120-5241.2 G1205241	4249 G1	B1.G222-0194.1 G2122194
T5161	B1.G102-0733.2 G1020733	16 076 904 80	B1.G120-5241.2 G1205241	4249 H2	B1.G224-0138.1 G2124138
T5162	B1.G102-0737.2 G1020737	16 086 916 80	B1.G213-0184.1 G2113184	4249 J6	B1.G226-0120.1 G2126120
T5162	B1.G102-0740.2 G1020740	4246 89	B1.G210-0187.1 G2110187	4249 K3	B1.G224-0127.1 G2124127
T5163	B1.G102-0503.2 G1020503	4246 94	B1.G220-0132.1 G2120132	4249 K6	B1.G216-0123.1 G2116123
T5164	B1.G102-0504.2 G1020504	4246 97	B1.G220-0133.1 G2120133	4249 K7	B1.G216-0124.1 G2116124
T5165	B1.G102-0515.2 G1020515	4246 A5	B1.G210-0187.1 G2110187	4249 L2	B1.G222-0197.1 G2122197
T5167	B1.G102-0735.2 G1020735	4246 A7	B1.G220-0132.1 G2120132	4250 35	B1.G102-0214.2 G1020214
T5168	B1.G102-0615.2 G1020615	4246 B1	B1.G220-0133.1 G2120133	4250 37	B1.G102-0213.2 G1020213
T5170	B1.G102-0482.2 G1020482	4246 F0	B1.G220-0180.1 G2120180	4250 39	B1.G102-0213.2 G1020213
T6031	B1.G102-0065.2 G1020065	4246 F8	B1.G208-0107.1 G2108107	4250 43	B1.G102-0214.2 G1020214
T6060	B1.G102-0065.2 G1020065	4246 G0	B1.G208-0107.1 G2108107	4250 50	B1.G102-0214.2 G1020214
T6064	B1.G102-0219.2 G1020219	4246 G6	B1.G208-0106.1 G2108106	4250 51	B1.G102-0214.2 G1020214
T6064	B1.G102-0323.2 G1020323	4246 H8	B1.G220-0155.1 G2120155	4250 54	B1.G102-0147.2 G1020147
T6064-ECO	B1.G102-0219.2 G1020219	4246 K2	B1.G224-0138.1 G2124138	4250 56	B1.G102-0201.2 G1020201
T6065	B1.G102-0216.2 G1020216	4246 L2	B1.G224-0127.1 G2124127	4250 67	B1.G102-0065.2 G1020065
T6065	B1.G102-0522.2 G1020522	4246 L7	B1.G210-0230.1 G2110230	4250 69	B1.G102-0214.2 G1020214
T6088	B1.G102-0214.2 G1020214	4246 N0	B1.G226-0106.1 G2126106	4250 71	B1.G102-0216.2 G1020216
T6088	B1.G102-0296.2 G1020296	4246 P9	B1.G212-0162.1 G2112162	4250 72	B1.G102-0214.2 G1020214
T6088-ECO	B1.G102-0214.2 G1020214	4246 R2	B1.G213-0184.1 G2113184	4250 76	B1.G102-0214.2 G1020214
T6112	B1.G102-0326.2 G1020326	4246 R3	B1.G220-0133.1 G2120133	4250 82	B1.G102-0213.2 G1020213
T9003	B1.G102-0141.2 G1020141	4246 R7	B1.G226-0106.1 G2126106	4250 88	B1.G102-0214.2 G1020214
T9008	B1.G102-0329.2 G1020329	4246 R8	B1.G213-0185.1 G2113185	4250 90	B1.G102-0275.2 G1020275
T9009	B1.G102-0140.2 G1020140	4246 T6	B1.G210-0230.1 G2110230	4250 91	B1.G102-0296.2 G1020296
T9012	B1.G102-0423.2 G1020423	4246 T7	B1.G210-0230.1 G2110230	4250 92	B1.G102-0296.2 G1020296
T9012-ECO	B1.G102-0423.2 G1020423	4246 W5	B1.G220-0133.1 G2120133	4250 97	B1.G102-0214.2 G1020214
T9021	B1.G102-0259.2 G1020259	4246 W7	B1.G222-0194.1 G2122194	4251 02	B1.G102-0295.2 G1020295
T9026	B1.G102-0886.2 G1020886	4246 W8	B1.G226-0120.1 G2126120	4251 03	B1.G102-0292.2 G1020292
T9027	B1.G102-0885.2 G1020885	4246 W9	B1.G209-0137.1 G2109137	4251 04	B1.G102-0216.2 G1020216
T9028	B1.G102-0295.2 G1020295	4246 X9	B1.G224-0127.1 G2124127	4251 06	B1.G102-0147.2 G1020147
T9029	B1.G102-0296.2 G1020296	4246 Y1	B1.G224-0127.1 G2124127	4251 09	B1.G102-0310.2 G1020310
T9029-ECO	B1.G102-0296.2 G1020296	4246 Y3	B1.G224-0138.1 G2124138	4251 11	B1.G102-0291.2 G1020291
T9030	B1.G102-0298.2 G1020298	4246 Y5	B1.G224-0138.1 G2124138	4251 16	B1.G102-0301.2 G1020301
T9031	B1.G102-0621.2 G1020621	4246 Y9	B1.G216-0124.1 G2116124	4251 18	B1.G102-0302.2 G1020302
T9033	B1.G102-0326.2 G1020326	4248 33	B1.G102-0147.2 G1020147	4251 20	B1.G102-0296.2 G1020296
T9037	B1.G102-0327.2 G1020327	4248 64	B1.G102-0065.2 G1020065	4251 21	B1.G102-0292.2 G1020292
T9038	B1.G102-0328.2 G1020328	4249 15	B1.G222-0194.1 G2122194	4251 22	B1.G102-0292.2 G1020292
T9049	B1.G102-0777.2 G1020777	4249 17	B1.G226-0120.1 G2126120	4251 30	B1.G102-0373.2 G1020373
T9054	B1.G102-0350.2 G1020350	4249 26	B1.G224-0127.1 G2124127	4251 31	B1.G102-0362.2 G1020362
T9057	B1.G102-0891.2 G1020891	4249 30	B1.G216-0124.1 G2116124	4251 32	B1.G102-0363.2 G1020363
T9062	B1.G102-0459.2 G1020459	4249 35	B1.G224-0138.1 G2124138	4251 34	B1.G102-0293.2 G1020293
T9066	B1.G102-0554.2 G1020554	4249 41	B1.G216-0123.1 G2116123	4251 41	B1.G102-0215.2 G1020215
T9069	B1.G102-0423.2 G1020423	4249 52	B1.G209-0137.1 G2109137	4251 42	B1.G102-0293.2 G1020293
T9069-ECO	B1.G102-0423.2 G1020423	4249 54	B1.G220-0180.1 G2120180	4251 43	B1.G102-0363.2 G1020363
T9070	B1.G102-0497.2 G1020497	4249 73	B1.G222-0197.1 G2122197	4251 48	B1.G102-0216.2 G1020216
T9073	B1.G102-0497.2 G1020497	4249 75	B1.G222-0147.1 G2122147	4251 51	B1.G102-0350.2 G1020350
T9096	B1.G102-0513.2 G1020513	4249 83	B1.G222-0194.1 G2122194	4251 52	B1.G102-0513.2 G1020513
T9098	B1.G102-0597.2 G1020597	4249 84	B1.G226-0120.1 G2126120	4251 54	B1.G102-0451.2 G1020451



# Cross reference list

Liste des correspondances / Tabella di conversione codici / Lista de comparação /



Lista porównawcza numerów / Porovnávací seznam čísel

PEUGEOT		PEUGEOT		PORSCHE				
4251 60	B1.G102-0363.2	G1020363	4254 10	B1.G102-0762.2	G1020762	955 351 939 00	B1.G102-0709.2	G1020709
4251 64	B1.G102-0443.2	G1020443	4254 12	B1.G102-0790.2	G1020790	955 351 939 01	B1.G102-0709.2	G1020709
4251 65	B1.G102-0215.2	G1020215	4254 14	B1.G102-0921.2	G1020921	955 351 939 02	B1.G102-0709.2	G1020709
4251 67	B1.G102-0293.2	G1020293	4254 17	B1.G102-0920.2	G1020920	955 351 939 03	B1.G102-0709.2	G1020709
4251 93	B1.G102-0487.2	G1020487	4254 18	B1.G102-0735.2	G1020735	955 351 939 04	B1.G102-0709.2	G1020709
4251 96	B1.G102-0522.2	G1020522	4254 19	B1.G102-0995.2	G1020995	955 351 939 05	B1.G102-0709.2	G1020709
4252 08	B1.G102-0487.2	G1020487	4254 21	B1.G102-0660.2	G1020660	955 351 939 10	B1.G102-0710.2	G1020710
4252 20	B1.G102-0514.2	G1020514	4254 22	B1.G102-0761.2	G1020761	955 351 939 11	B1.G102-0710.2	G1020710
4252 22	B1.G102-0735.2	G1020735	4254 24	B1.G102-0893.2	G1020893	955 351 939 12	B1.G102-0710.2	G1020710
4252 23	B1.G102-0492.2	G1020492	4254 25	B1.G102-0790.2	G1020790	955 351 939 13	B1.G102-0710.2	G1020710
4252 24	B1.G102-0482.2	G1020482	4254 26	B1.G102-0859.2	G1020859	955 351 939 14	B1.G102-0710.2	G1020710
4252 25	B1.G102-0483.2	G1020483	4254 28	B1.G102-0920.2	G1020920	955 351 939 15	B1.G102-0710.2	G1020710
4252 29	B1.G102-0513.2	G1020513	4254 29	B1.G102-0921.2	G1020921	955 351 939 50	B1.G120-1066.2	G1201066
4252 32	B1.G102-0549.2	G1020549	4254 35	B1.G102-0946.2	G1020946	955 351 939 51	B1.G120-1066.2	G1201066
4252 42	B1.G102-0516.2	G1020516	4254 42	B1.G102-0522.2	G1020522	955 351 939 61	B1.G120-1079.2	G1201079
4252 44	B1.G102-0517.2	G1020517	4254 44	B1.G102-0946.2	G1020946	955 351 939 62	B1.G120-1079.2	G1201079
4252 46	B1.G102-0518.2	G1020518	4254 46	B1.G102-0946.2	G1020946	955 351 939 63	B1.G120-1079.2	G1201079
4252 50	B1.G102-0735.2	G1020735	4254 48	B1.G120-5230.2	G1205230	955 352 939 00	B1.G102-0711.2	G1020711
4252 52	B1.G102-0614.2	G1020614	4254 51	B1.G102-0301.2	G1020301	955 352 939 01	B1.G102-0711.2	G1020711
4252 56	B1.G102-0216.2	G1020216	4254 52	B1.G102-0302.2	G1020302	955 352 939 02	B1.G102-0711.2	G1020711
4252 60	B1.G102-0745.2	G1020745	4254 53	B1.G102-0310.2	G1020310	955 352 939 50	B1.G102-0711.2	G1020711
4252 66	B1.G102-0487.2	G1020487	4254 54	B1.G102-0350.2	G1020350	955 352 939 62	B1.G102-0999.2	G1020999
4252 68	B1.G102-0362.2	G1020362	4254 55	B1.G102-0482.2	G1020482	986 352 939 10	B1.G102-0883.2	G1020883
4252 71	B1.G102-0522.2	G1020522	4254 56	B1.G102-0483.2	G1020483	996 351 939 15	B1.G102-0882.2	G1020882
4252 77	B1.G102-0761.2	G1020761	4254 57	B1.G102-0514.2	G1020514	996 351 939 16	B1.G102-0882.2	G1020882
4252 78	B1.G102-0762.2	G1020762	4254 58	B1.G102-0516.2	G1020516	996 351 949 11	B1.G102-0785.2	G1020785
4252 79	B1.G102-0660.2	G1020660	4254 59	B1.G102-0517.2	G1020517	996 351 949 12	B1.G102-0785.2	G1020785
4253 14	B1.G102-0295.2	G1020295	4254 61	B1.G102-0763.2	G1020763	996 352 939 00	B1.G102-0883.2	G1020883
4253 22	B1.G102-0630.2	G1020630	4254 62	B1.G102-0872.2	G1020872	996 352 939 03	B1.G102-0883.2	G1020883
4253 26	B1.G102-0660.2	G1020660	4254 63	B1.G102-0764.2	G1020764	996 352 949 02	B1.G102-0882.2	G1020882
4253 27	B1.G102-0830.2	G1020830	4254 64	B1.G102-0873.2	G1020873	996 352 949 03	B1.G102-0882.2	G1020882
4253 35	B1.G102-0761.2	G1020761	4254 65	B1.G102-0790.2	G1020790			
4253 36	B1.G102-0762.2	G1020762	4254 66	B1.G102-0291.2	G1020291			
4253 37	B1.G102-0762.2	G1020762	4254 67	B1.G102-0492.2	G1020492			
4253 39	B1.G102-0735.2	G1020735	4254 68	B1.G102-0518.2	G1020518	40 20 600 10R	B1.G224-0221.1	G2124221
4253 40	B1.G102-0630.2	G1020630	4254 69	B1.G102-0730.2	G1020730	40 20 612 00R	B1.G222-0270.1	G2122270
4253 43	B1.G102-0745.2	G1020745	4254 71	B1.G102-0735.2	G1020735	41 06 000 11R	B1.G102-0834.2	G1020834
4253 47	B1.G102-0761.2	G1020761	4254 74	B1.G102-0830.2	G1020830	41 06 000 23R	B1.G120-1029.2	G1201029
4253 48	B1.G102-0762.2	G1020762	4254 77	B1.G102-0792.2	G1020792	41 06 007 56R	B1.G102-0867.2	G1020867
4253 55	B1.G102-0763.2	G1020763	4254 78	B1.G102-0761.2	G1020761	41 06 021 92R	B1.G102-0501.2	G1020501
4253 57	B1.G102-0872.2	G1020872	4254 82	B1.G102-0293.2	G1020293	41 06 037 50R	B1.G102-0875.2	G1020875
4253 59	B1.G102-0730.2	G1020730	4254 84	B1.G102-0513.2	G1020513	41 06 043 86R	B1.G102-0905.2	G1020905
4253 63	B1.G102-0937.2	G1020937	4254 88	B1.G102-0745.2	G1020745	41 06 047 75R	B1.G102-0741.2	G1020741
4253 65	B1.G102-0937.2	G1020937	4254 89	B1.G102-0735.2	G1020735	41 06 075 85R	B1.G102-0834.2	G1020834
4253 67	B1.G102-0938.2	G1020938	4254 91	B1.G102-0660.2	G1020660	41 06 084 81R	B1.G102-0741.2	G1020741
4253 73	B1.G102-0764.2	G1020764	4254 92	B1.G102-0614.2	G1020614	41 06 087 13R	B1.G102-0685.2	G1020685
4253 75	B1.G102-0873.2	G1020873	4254 96	B1.G102-0740.2	G1020740	44 06 002 95R	B1.G102-0920.2	G1020920
4253 78	B1.G102-0570.2	G1020570	4254 97	B1.G102-0938.2	G1020938	44 06 003 64R	B1.G102-0489.2	G1020489
4253 83	B1.G102-0762.2	G1020762	4254 A0	B1.G102-0762.2	G1020762	44 06 011 47R	B1.G102-0907.2	G1020907
4253 85	B1.G102-0735.2	G1020735	4254 A2	B1.G102-0937.2	G1020937	44 06 020 70R	B1.G102-0920.2	G1020920
4253 90	B1.G120-5230.2	G1205230	4254 A3	B1.G102-0762.2	G1020762	44 06 039 05R	B1.G120-1126.2	G1201126
4253 93	B1.G102-0859.2	G1020859	4254 A6	B1.G120-1070.2	G1201070	44 06 058 39R	B1.G102-0489.2	G1020489
4253 96	B1.G102-0920.2	G1020920	4254 A7	B1.G120-1073.2	G1201073	44 06 062 67R	B1.G102-0874.2	G1020874
4253 98	B1.G102-0630.2	G1020630	4254 A8	B1.G120-1069.2	G1201069	44 06 087 46R	B1.G102-0834.2	G1020834
4254 01	B1.G102-0995.2	G1020995	4254 C5	B1.G102-0549.2	G1020549	60 01 547 619	B1.G102-0501.2	G1020501
4254 06	B1.G102-0740.2	G1020740	4254 C8	B1.G120-1224.2	G1201224	60 01 547 683	B1.G212-0171.1	G2112171
4254 08	B1.G102-0738.2	G1020738				60 01 547 684	B1.G212-0116.1	G2112116
						60 01 547 911	B1.G102-0501.2	G1020501

# Cross reference list

Liste des correspondances / Tabella di conversione codici / Lista de comparação /

Lista porównawcza numerów / Porovnávací seznam čísel



RENAULT 	RENAULT 	RENAULT 
60 01 549 211	B1.G212-0116.1 G2112116	77 01 202 896
60 25 071 042	B1.G102-0501.2 G1020501	77 01 202 954
60 25 308 186	B1.G102-0327.2 G1020327	77 01 202 973
60 25 315 867	B1.G102-0459.2 G1020459	77 01 203 070
60 25 370 398	B1.G102-0459.2 G1020459	77 01 203 124
60 25 371 279	B1.G102-0633.2 G1020633	77 01 203 129
60 25 371 650	B1.G102-0489.2 G1020489	77 01 203 282
60 25 371 662	B1.G102-0633.2 G1020633	77 01 203 633
60 25 407 835	B1.G102-0459.2 G1020459	77 01 203 668
77 00 314 107	B1.G212-0155.1 G2112155	77 01 203 726
77 00 704 705	B1.G212-0116.1 G2112116	77 01 203 730
77 00 716 947	B1.G208-0104.1 G2108104	77 01 203 775
77 00 756 572	B1.G220-0125.1 G2120125	77 01 203 795
77 00 780 077	B1.G208-0108.1 G2108108	77 01 203 796
77 00 780 078	B1.G208-0108.1 G2108108	77 01 203 797
77 00 780 892	B1.G221-0106.1 G2121106	77 01 203 842
77 00 802 231	B1.G224-0171.1 G2124171	77 01 203 919
77 00 802 232	B1.G222-0148.1 G2122148	77 01 203 968
77 00 805 006	B1.G208-0109.1 G2108109	77 01 204 036
77 00 805 148	B1.G208-0109.1 G2108109	77 01 204 066
77 00 813 549	B1.G221-0106.1 G2121106	77 01 204 220
77 00 829 553	B1.G208-0108.1 G2108108	77 01 204 282
77 00 830 283	B1.G224-0171.1 G2124171	77 01 204 285
77 00 841 563	B1.G222-0148.1 G2122148	77 01 204 286
77 00 842 131	B1.G221-0106.1 G2121106	77 01 204 293
77 01 050 914	B1.G102-0633.2 G1020633	77 01 204 294
77 01 050 918	B1.G102-0529.2 G1020529	77 01 204 302
77 01 054 771	B1.G102-0633.2 G1020633	77 01 204 303
77 01 054 772	B1.G102-0529.2 G1020529	77 01 204 304
77 01 200 355	B1.G102-0065.2 G1020065	77 01 204 305
77 01 201 542	B1.G102-0214.2 G1020214	77 01 204 357
77 01 201 669	B1.G102-0501.2 G1020501	77 01 204 358
77 01 202 050	B1.G102-0326.2 G1020326	77 01 204 495
77 01 202 057	B1.G102-0214.2 G1020214	77 01 204 523
77 01 202 210	B1.G102-0216.2 G1020216	77 01 204 530
77 01 202 213	B1.G102-0219.2 G1020219	77 01 204 626
77 01 202 227	B1.G102-0219.2 G1020219	77 01 204 664
77 01 202 283	B1.G102-0214.2 G1020214	77 01 204 708
77 01 202 284	B1.G102-0501.2 G1020501	77 01 204 828
77 01 202 285	B1.G102-0501.2 G1020501	77 01 204 833
77 01 202 289	B1.G102-0501.2 G1020501	77 01 204 845
77 01 202 308	B1.G102-0216.2 G1020216	77 01 204 901
77 01 202 475	B1.G102-0214.2 G1020214	77 01 204 903
77 01 202 516	B1.G102-0501.2 G1020501	77 01 205 015
77 01 202 517	B1.G102-0219.2 G1020219	77 01 205 085
77 01 202 518	B1.G102-0214.2 G1020214	77 01 205 086
77 01 202 662	B1.G102-0216.2 G1020216	77 01 205 228
77 01 202 710	B1.G102-0219.2 G1020219	77 01 205 230
77 01 202 711	B1.G102-0214.2 G1020214	77 01 205 231
77 01 202 712	B1.G102-0501.2 G1020501	77 01 205 277
77 01 202 847	B1.G102-0214.2 G1020214	77 01 205 355
77 01 202 848	B1.G102-0501.2 G1020501	77 01 205 513
77 01 202 890	B1.G102-0065.2 G1020065	77 01 205 653
77 01 202 891	B1.G102-0219.2 G1020219	77 01 205 840
77 01 202 892	B1.G102-0214.2 G1020214	77 01 205 842
77 01 202 894	B1.G102-0501.2 G1020501	77 01 205 843
77 01 202 895	B1.G102-0501.2 G1020501	77 01 205 995
		B1.G102-0326.2 G1020326
		B1.G102-0065.2 G1020065
		B1.G102-0326.2 G1020326
		B1.G102-0326.2 G1020326
		B1.G102-0327.2 G1020327
		B1.G102-0501.2 G1020501
		B1.G102-0501.2 G1020501
		B1.G102-0327.2 G1020327
		B1.G102-0777.2 G1020777
		B1.G102-0327.2 G1020327
		B1.G102-0326.2 G1020326
		B1.G102-0501.2 G1020501
		B1.G102-0501.2 G1020501
		B1.G102-0501.2 G1020501
		B1.G102-0323.2 G1020323
		B1.G102-0777.2 G1020777
		B1.G102-0326.2 G1020326
		B1.G102-0777.2 G1020777
		B1.G102-0501.2 G1020501
		B1.G102-0326.2 G1020326
		B1.G212-0116.1 G2112116
		B1.G208-0104.1 G2108104
		B1.G220-0125.1 G2120125
		B1.G208-0108.1 G2108108
		B1.G221-0106.1 G2121106
		B1.G220-0125.1 G2120125
		B1.G208-0108.1 G2108108
		B1.G208-0108.1 G2108108
		B1.G221-0106.1 G2121106
		B1.G220-0125.1 G2120125
		B1.G208-0109.1 G2108109
		B1.G221-0106.1 G2121106
		B1.G224-0171.1 G2124171
		B1.G102-0501.2 G1020501
		B1.G102-0501.2 G1020501
		B1.G222-0148.1 G2122148
		B1.G208-0108.1 G2108108
		B1.G102-0214.2 G1020214
		B1.G102-0216.2 G1020216
		B1.G102-0216.2 G1020216
		B1.G102-0216.2 G1020216
		B1.G102-0214.2 G1020214
		B1.G221-0106.1 G2121106
		B1.G102-0501.2 G1020501
		B1.G102-0216.2 G1020216
		B1.G208-0108.1 G2108108
		B1.G102-0214.2 G1020214
		B1.G102-0216.2 G1020216
		B1.G102-0216.2 G1020216
		B1.G102-0214.2 G1020214
		B1.G221-0106.1 G2121106
		B1.G102-0501.2 G1020501
		B1.G102-0216.2 G1020216
		B1.G208-0108.1 G2108108
		B1.G102-0214.2 G1020214
		B1.G102-0327.2 G1020327
		B1.G222-0148.1 G2122148
		B1.G224-0158.1 G2124158
		B1.G222-0148.1 G2122148
		B1.G224-0158.1 G2124158
		B1.G224-0171.1 G2124171
		B1.G102-0323.2 G1020323
		B1.G102-0501.2 G1020501
		B1.G102-0497.2 G1020497
		B1.G221-0106.1 G2121106
		B1.G222-0148.1 G2122148
		B1.G224-0158.1 G2124158
		B1.G222-0170.1 G2122270
		B1.G102-0876.2 G1020876
		B1.G102-0501.2 G1020501
		B1.G102-0497.2 G1020497
		B1.G102-0501.2 G1020501
		B1.G224-0158.1 G2124158
		B1.G224-0171.1 G2124171
		B1.G102-0501.2 G1020501
		B1.G221-0106.1 G2121106
		B1.G222-0170.1 G2122270
		B1.G102-0876.2 G1020876
		B1.G102-0501.2 G1020501
		B1.G102-0875.2 G1020875
		B1.G102-0874.2 G1020874
		B1.G222-0270.1 G2122270
		B1.G102-0876.2 G1020876
		B1.G102-0501.2 G1020501
		B1.G102-0065.2 G1020065



# Cross reference list

Liste des correspondances / Tabella di conversione codici / Lista de comparação /



Lista porównawcza numerów / Porovnávací seznam čísel

RENAULT 		SAAB 		SEAT 	
77 01 348 684	B1.G102-0065.2 G1020065	5232350	B1.G102-0642.2 G1020642	1HM 698 151 A	B1.G102-0444.2 G1020444
77 01 348 863	B1.G102-0065.2 G1020065	5390786	B1.G225-0119.1 G2125119	1J0 615 301 C	B1.G225-0113.1 G2125113
77 01 349 049	B1.G102-0065.2 G1020065	5391560	B1.G225-0142.1 G2125142	1J0 615 301 D	B1.G222-0151.1 G2122151
77 01 349 448	B1.G102-0065.2 G1020065	5392485	B1.G102-0642.2 G1020642	1J0 615 301 E	B1.G222-0150.1 G2122150
77 01 349 751	B1.G102-0501.2 G1020501	5532544	B1.G102-0642.2 G1020642	1J0 615 301 L	B1.G222-0151.1 G2122151
77 01 349 969	B1.G102-0214.2 G1020214	5533518	B1.G102-0642.2 G1020642	1J0 615 301 M	B1.G222-0150.1 G2122150
77 01 349 970	B1.G102-0501.2 G1020501	9156785	B1.G212-0157.1 G2112157	1J0 615 301 R	B1.G225-0113.1 G2125113
77 01 349 973	B1.G102-0501.2 G1020501	9156807	B1.G225-0141.1 G2125141	1J0 615 301 S	B1.G225-0113.1 G2125113
77 11 130 008	B1.G102-0214.2 G1020214	9184405	B1.G225-0142.1 G2125142	1J0 615 601	B1.G209-0123.1 G2109123
77 11 130 034	B1.G102-0214.2 G1020214	12759808	B1.G102-0403.2 G1020403	1J0 615 601 C	B1.G209-0123.1 G2109123
77 11 130 036	B1.G102-0501.2 G1020501	12762290	B1.G212-0157.1 G2112157	1J0 615 601 N	B1.G209-0123.1 G2109123
77 11 130 038	B1.G221-0106.1 G2121106	12765397	B1.G102-0650.2 G1020650	1J0 615 601 P	B1.G209-0123.1 G2109123
77 11 130 071	B1.G102-0501.2 G1020501	12799240	B1.G102-0670.2 G1020670	1J0 698 151	B1.G102-0331.2 G1020331
77 11 130 077	B1.G228-0132.1 G2128132	12800120	B1.G102-0650.2 G1020650	1J0 698 151 A	B1.G102-0331.2 G1020331
77 11 130 086	B1.G102-0871.2 G1020871	12802167	B1.G102-0756.2 G1020756	1J0 698 151 B	B1.G102-0331.2 G1020331
82 00 007 121	B1.G224-0169.1 G2124169	12803551	B1.G102-0650.2 G1020650	1J0 698 151 D	B1.G102-0463.2 G1020463
82 00 010 519	B1.G228-0132.1 G2128132	13237750	B1.G120-1143.2 G1201143	1J0 698 151 E	B1.G102-0463.2 G1020463
86 71 000 107	B1.G102-0501.2 G1020501	13237751	B1.G120-1145.2 G1201145	1J0 698 151 G	B1.G102-0463.2 G1020463
86 71 016 173	B1.G102-0501.2 G1020501	13237752	B1.G120-1147.2 G1201147	1J0 698 151 J	B1.G102-0331.2 G1020331
		13322091	B1.G102-0727.2 G1020727	1J0 698 151 L	B1.G102-0379.2 G1020379
		13338368	B1.G120-1149.2 G1201149	1J0 698 151 M	B1.G102-0512.2 G1020512
<b>ROLLCE ROYCE</b>		24435132	B1.G228-0164.1 G2128164	1J0 698 451	B1.G102-0755.2 G1020755
PC57341PA	B1.G102-0683.2 G1020683	32025723	B1.G225-0119.1 G2125119	1J0 698 451 F	B1.G102-0755.2 G1020755
<b>ROVER</b>		93166943	B1.G102-0650.2 G1020650	1J0 698 451 J	B1.G102-0755.2 G1020755
EGP1254	B1.G210-0212.1 G2110212	93171497	B1.G225-0141.1 G2125141	1J0 698 451 P	B1.G102-0755.2 G1020755
GBD90817	B1.G210-0212.1 G2110212	93175606	B1.G228-0164.1 G2128164	1K0 615 301 AA	B1.G225-0158.1 G2125158
GBD90840	B1.G221-0105.1 G2121105	93183140	B1.G102-0670.2 G1020670	1K0 615 301 AC	B1.G222-0210.1 G2122210
GBP90341AF	B1.G102-0316.2 G1020316	93185751	B1.G102-0650.2 G1020650	1K0 615 301 AK	B1.G222-0210.1 G2122210
SDB000990	B1.G221-0105.1 G2121105	93188111	B1.G102-0650.2 G1020650	1K0 615 301 S	B1.G222-0210.1 G2122210
SDB100600	B1.G221-0105.1 G2121105	93188113	B1.G102-0756.2 G1020756	1K0 615 301 T	B1.G225-0145.1 G2125145
SFP000040	B1.G102-0591.2 G1020591	93190338	B1.G102-0727.2 G1020727	1K0 615 601 AA	B1.G210-0356.1 G2110356
SFP100520	B1.G102-0316.2 G1020316	93190340	B1.G102-0756.2 G1020756	1K0 615 601 AB	B1.G210-0277.1 G2110277
		93192749	B1.G102-0642.2 G1020642	1K0 615 601 AC	B1.G212-0158.1 G2112158
		93195754	B1.G102-0772.2 G1020772	1K0 615 601 AD	B1.G212-0169.1 G2112169
<b>SAAB</b>				1K0 615 601 K	B1.G210-0277.1 G2110277
4467049	B1.G102-0369.2 G1020369		<b>SEAT</b>	1K0 615 601 L	B1.G212-0158.1 G2112158
4467072	B1.G102-0272.2 G1020272	140 698 151 B	B1.G102-0390.2 G1020390	1K0 615 601 M	B1.G212-0169.1 G2112169
4478254	B1.G102-0403.2 G1020403	191 698 151 F	B1.G102-0025.2 G1020025	1K0 698 151	B1.G102-0680.2 G1020680
4483723	B1.G102-0369.2 G1020369	191 698 151 G	B1.G102-0010.2 G1020010	1K0 698 151 A	B1.G102-0463.2 G1020463
4566840	B1.G225-0119.1 G2125119	191 698 151 H	B1.G102-0009.2 G1020009	1K0 698 151 D	B1.G102-0463.2 G1020463
4567798	B1.G225-0142.1 G2125142	191 698 151 J	B1.G102-0009.2 G1020009	1K0 698 151 E	B1.G102-0680.2 G1020680
4646899	B1.G102-0369.2 G1020369	191 698 151 K	B1.G102-0009.2 G1020009	1K0 698 151 F	B1.G102-0463.2 G1020463
4648457	B1.G102-0369.2 G1020369	191 698 151 C	B1.G102-0201.2 G1020201	1K0 698 151 J	B1.G102-0463.2 G1020463
4778254	B1.G102-0642.2 G1020642	191 698 451 D	B1.G102-0201.2 G1020201	1K0 698 451 A	B1.G102-0492.2 G1020492
4836987	B1.G102-0271.2 G1020271	1H0 698 151	B1.G102-0009.2 G1020009	1K0 698 451 C	B1.G102-0492.2 G1020492
4837019	B1.G225-0119.1 G2125119	1H0 698 151 A	B1.G102-0355.2 G1020355	1K0 698 451 G	B1.G102-0682.2 G1020682
4837241	B1.G102-0271.2 G1020271	1H0 698 151 B	B1.G102-0390.2 G1020390	1K0 698 451 J	B1.G102-0492.2 G1020492
4839007	B1.G225-0119.1 G2125119	1H0 698 451	B1.G102-0345.2 G1020345	321 615 301	B1.G212-0106.1 G2112106
4839320	B1.G225-0119.1 G2125119	1H0 698 451 A	B1.G102-0345.2 G1020345	321 615 301 C	B1.G220-0123.1 G2120123
4839924	B1.G102-0642.2 G1020642	1H0 698 451 B	B1.G102-0201.2 G1020201	321 615 301 D	B1.G220-0128.1 G2120128
5055371	B1.G102-0642.2 G1020642	1H0 698 451 C	B1.G102-0201.2 G1020201	357 615 301	B1.G213-0178.1 G2113178
5055389	B1.G225-0142.1 G2125142	1H0 698 451 D	B1.G102-0201.2 G1020201	357 615 601	B1.G210-0111.1 G2110111
5057336	B1.G102-0271.2 G1020271	1H0 698 451 E	B1.G102-0345.2 G1020345	357 698 151 A	B1.G102-0273.2 G1020273
5058110	B1.G102-0316.2 G1020316	1H0 698 451 F	B1.G102-0201.2 G1020201	357 698 151 B	B1.G102-0274.2 G1020274
5062203	B1.G102-0642.2 G1020642	1H0 698 451 G	B1.G102-0345.2 G1020345	357 698 151 E	B1.G102-0444.2 G1020444
5062211	B1.G102-0642.2 G1020642	1H0 698 451 H	B1.G102-0201.2 G1020201	3A0 698 151	B1.G102-0379.2 G1020379
5064795	B1.G102-0642.2 G1020642	1HM 698 151	B1.G102-0444.2 G1020444	3A0 698 151 A	B1.G102-0379.2 G1020379
5124078	B1.G102-0642.2 G1020642				

# Cross reference list

Liste des correspondances / Tabella di conversione codici / Lista de comparação /

Lista porównawcza numerów / Porovnávací seznam čísel

SEAT		SKODA		SKODA				
3C0 698 151 B	B1.G102-0680.2	G1020680	002 415 019	B1.G213-0182.1	G2113182	3B0 698 451 A	B1.G102-0492.2	G1020492
3C0 698 151 C	B1.G102-0680.2	G1020680	1H0 698 151 B	B1.G102-0390.2	G1020390	3C0 698 151 B	B1.G102-0680.2	G1020680
3C0 698 451 D	B1.G102-0993.2	G1020993	1J0 615 301 C	B1.G225-0113.1	G2125113	3C0 698 151 C	B1.G102-0680.2	G1020680
3C0 698 451 E	B1.G102-0993.2	G1020993	1J0 615 301 D	B1.G222-0151.1	G2122151	4A0 615 301 C	B1.G225-0105.1	G2125105
3C0 698 451 F	B1.G102-0993.2	G1020993	1J0 615 301 E	B1.G222-0150.1	G2122150	4A0 615 601 A	B1.G210-0201.1	G2110201
5C0 698 151	B1.G102-0331.2	G1020331	1J0 615 301 L	B1.G222-0151.1	G2122151	4B0 615 301 A	B1.G225-0137.1	G2125137
5K0 698 151	B1.G102-0680.2	G1020680	1J0 615 301 M	B1.G222-0150.1	G2122150	4B0 615 301 B	B1.G225-0171.1	G2125171
5N0 698 451	B1.G102-0993.2	G1020993	1J0 615 301 R	B1.G225-0113.1	G2125113	4B0 698 151 N	B1.G102-0313.2	G1020313
6N0 615 301	B1.G210-0232.1	G2110232	1J0 615 601	B1.G209-0123.1	G2109123	5C0 698 151	B1.G102-0331.2	G1020331
6N0 615 301 C	B1.G218-0106.1	G2118106	1J0 615 601 C	B1.G209-0123.1	G2109123	5K0 698 151	B1.G102-0680.2	G1020680
6N0 615 301 D	B1.G220-0128.1	G2120128	1J0 615 601 D	B1.G209-0133.1	G2109133	5K0 698 151 A	B1.G102-0680.2	G1020680
6N0 615 601 A	B1.G209-0124.1	G2109124	1J0 615 601 N	B1.G209-0123.1	G2109123	6N0 698 151 C	B1.G102-0408.2	G1020408
6N0 615 601 B	B1.G209-0124.1	G2109124	1J0 615 601 P	B1.G209-0123.1	G2109123	6Q0 615 301	B1.G218-0137.1	G2118137
6N0 698 151	B1.G102-0408.2	G1020408	1J0 698 151	B1.G102-0331.2	G1020331	6Q0 698 151	B1.G102-0331.2	G1020331
6N0 698 151 C	B1.G102-0408.2	G1020408	1J0 698 151 A	B1.G102-0331.2	G1020331	6Q0 698 151 A	B1.G102-0732.2	G1020732
6Q0 698 151	B1.G102-0331.2	G1020331	1J0 698 151 B	B1.G102-0331.2	G1020331	6Q0 698 151 B	B1.G102-0409.2	G1020409
6Q0 698 151 A	B1.G102-0732.2	G1020732	1J0 698 151 D	B1.G102-0463.2	G1020463	6Q0 698 151 C	B1.G102-0733.2	G1020733
6Q0 698 151 C	B1.G102-0733.2	G1020733	1J0 698 151 E	B1.G102-0463.2	G1020463	6Q0 698 451	B1.G102-0566.2	G1020566
6Q0 698 451	B1.G102-0566.2	G1020566	1J0 698 151 G	B1.G102-0463.2	G1020463	6Q0 698 451 B	B1.G102-0566.2	G1020566
6Q0 698 451 B	B1.G102-0566.2	G1020566	1J0 698 151 J	B1.G102-0331.2	G1020331	6R0 615 301	B1.G222-0151.1	G2122151
6R0 615 301	B1.G222-0151.1	G2122151	1J0 698 151 L	B1.G102-0379.2	G1020379	6R0 615 301 A	B1.G225-0113.1	G2125113
6R0 615 301 B	B1.G225-0123.1	G2125123	1J0 698 151 M	B1.G102-0512.2	G1020512	6R0 615 301 B	B1.G225-0123.1	G2125123
6R0 698 151 A	B1.G102-0331.2	G1020331	1J0 698 451	B1.G102-0755.2	G1020755	6R0 698 151 A	B1.G102-0331.2	G1020331
6X0 698 451 A	B1.G102-0549.2	G1020549	1J0 698 451 F	B1.G102-0755.2	G1020755	6U0 615 301	B1.G213-0182.1	G2113182
7D0 698 451 F	B1.G102-0654.2	G1020654	1J0 698 451 J	B1.G102-0755.2	G1020755	8D0 615 301 J	B1.G225-0137.1	G2125137
7M0 615 301 E	B1.G225-0114.1	G2125114	1J0 698 451 M	B1.G102-0755.2	G1020755	8E0 615 301 Q	B1.G225-0105.1	G2125105
7M0 615 301 G	B1.G225-0114.1	G2125114	1J0 698 451 P	B1.G102-0755.2	G1020755	8E0 615 301 R	B1.G225-0137.1	G2125137
7M0 615 601 A	B1.G210-0223.1	G2110223	1J0 698 451 S	B1.G102-0755.2	G1020755	8E0 615 601	B1.G210-0201.1	G2110201
7M0 615 601 B	B1.G210-0223.1	G2110223	1K0 615 301 AA	B1.G225-0158.1	G2125158	8E0 698 151 J	B1.G102-0313.2	G1020313
7M0 615 601 C	B1.G210-0223.1	G2110223	1K0 615 301 AC	B1.G222-0210.1	G2122210	8E0 698 451 A	B1.G102-0492.2	G1020492
7M0 698 151	B1.G102-0312.2	G1020312	1K0 615 301 AK	B1.G222-0210.1	G2122210	8E0 698 451 K	B1.G102-0492.2	G1020492
7M0 698 151 A	B1.G102-0312.2	G1020312	1K0 615 301 M	B1.G230-0115.1	G2130115	8N0 615 301 A	B1.G225-0123.1	G2125123
7M0 698 151 B	B1.G102-0312.2	G1020312	1K0 615 301 S	B1.G222-0210.1	G2122210	8N0 698 151	B1.G102-0379.2	G1020379
7M0 698 451	B1.G102-0549.2	G1020549	1K0 615 301 T	B1.G225-0145.1	G2125145	8N0 698 151 A	B1.G102-0512.2	G1020512
7M3 698 151	B1.G102-0557.2	G1020557	1K0 615 601 AA	B1.G210-0356.1	G2110356	8Z0 698 151 A	B1.G102-0463.2	G1020463
7M3 698 151 A	B1.G102-0580.2	G1020580	1K0 615 601 AB	B1.G210-0277.1	G2110277	JZW 698 451 A	B1.G102-0755.2	G1020755
7M3 698 151 B	B1.G102-0593.2	G1020593	1K0 615 601 AC	B1.G212-0158.1	G2112158			
7M3 698 451	B1.G102-0564.2	G1020564	1K0 615 601 AD	B1.G212-0169.1	G2112169	<b>SMART (MCC)</b>		
7M3 698 451 A	B1.G102-0549.2	G1020549	1K0 615 601 K	B1.G210-0277.1	G2110277	000 1431 V002 000000	B1.G102-0540.2	G1020540
7M3 698 451 B	B1.G102-0564.2	G1020564	1K0 615 601 L	B1.G212-0158.1	G2112158	000 1431 V003 000000	B1.G102-0540.2	G1020540
7M3 698 451 C	B1.G102-0564.2	G1020564	1K0 615 601 M	B1.G212-0169.1	G2112169	000 4341 V001 000000	B1.G209-0136.1	G2109136
7M3 698 451 D	B1.G102-0654.2	G1020654	1K0 698 151	B1.G102-0680.2	G1020680	000 4341 V002 000000	B1.G209-0136.1	G2109136
7M3 698 451 F	B1.G102-0654.2	G1020654	1K0 698 151 A	B1.G102-0463.2	G1020463	414 596 00 02	B1.G102-0540.2	G1020540
7N0 698 151	B1.G102-0992.2	G1020992	1K0 698 151 B	B1.G102-0753.2	G1020753	451 421 00 10	B1.G102-0540.2	G1020540
811 615 301	B1.G210-0151.1	G2110151	1K0 698 151 D	B1.G102-0463.2	G1020463	451 421 01 10	B1.G102-0540.2	G1020540
8E0 698 151 G	B1.G102-0754.2	G1020754	1K0 698 151 E	B1.G102-0680.2	G1020680	454 420 09 20	B1.G102-0779.2	G1020779
8E0 698 151 K	B1.G102-0313.2	G1020313	1K0 698 151 F	B1.G102-0463.2	G1020463	454 420 10 20	B1.G102-0780.2	G1020780
8E0 698 151 L	B1.G102-0754.2	G1020754	1K0 698 151 J	B1.G102-0463.2	G1020463	454 421 00 10	B1.G102-0537.2	G1020537
8E0 698 451 J	B1.G102-0682.2	G1020682	1K0 698 451 C	B1.G102-0492.2	G1020492			
8E0 698 451 L	B1.G102-0676.2	G1020676	1K0 698 451 D	B1.G102-0682.2	G1020682			
8N0 615 301 A	B1.G225-0123.1	G2125123	1K0 698 451 F	B1.G102-0682.2	G1020682	<b>SUBARU</b>		
8N0 698 151	B1.G102-0379.2	G1020379	1K0 698 451 G	B1.G102-0682.2	G1020682	5581084E01	B1.G102-0605.2	G1020605
8N0 698 151 A	B1.G102-0512.2	G1020512	1K0 698 451 H	B1.G102-0682.2	G1020682	0446512610	B1.G120-1065.2	G1201065
8Z0 698 151 A	B1.G102-0463.2	G1020463	1K0 698 451 J	B1.G102-0492.2	G1020492	0446612130	B1.G102-0975.2	G1020975
JZW 698 451 A	B1.G102-0755.2	G1020755	1K0 698 451 K	B1.G102-0682.2	G1020682	26296AG040	B1.G120-5418.2	G1205418
			3A0 698 151	B1.G102-0379.2	G1020379	26296FE080	B1.G120-5418.2	G1205418
			3A0 698 151 A	B1.G102-0379.2	G1020379	26296FE081	B1.G120-5418.2	G1205418
						26296SA010	B1.G120-5418.2	G1205418

## Cross reference list

Liste des correspondances / Tabella di conversione codici / Lista de comparação /



Lista porównawcza numerów / Porovnávací seznam čísel

SUBARU		TOYOTA		TOYOTA	
26296SA011	B1.G120-5418.2 G1205418	04465-42160	B1.G120-1065.2 G1201065	43512-47020	B1.G225-0155.1 G2125155
26296SA030	B1.G120-5418.2 G1205418	04465-42180	B1.G102-0994.2 G1020994	43512-47030	B1.G222-0258.1 G2122258
		04465-42190	B1.G102-0994.2 G1020994	43512-52020	B1.G218-0131.1 G2118131
<b>SUZUKI</b>		04465-52010	B1.G102-0714.2 G1020714	43512-52040	B1.G220-0175.1 G2120175
55200-62850	B1.G120-1056.2 G1201056	04465-52011	B1.G102-0714.2 G1020714	43512-52050	B1.G218-0131.1 G2118131
55200-62851	B1.G120-1056.2 G1201056	04465-52021	B1.G102-0714.2 G1020714	43512-52090	B1.G220-0175.1 G2120175
55200-62852	B1.G120-1056.2 G1201056	04465-52022	B1.G102-0714.2 G1020714		
55200-65J00	B1.G120-1085.2 G1201085	04465-52060	B1.G102-0714.2 G1020714	<b>VAG</b>	
55200-65J10	B1.G120-1085.2 G1201085	04465-52120	B1.G102-0714.2 G1020714	171 698 151 E	B1.G102-0097.2 G1020097
55200-65J11	B1.G120-1085.2 G1201085	04465-52270	B1.G102-0974.2 G1020974	171 698 151 F	B1.G102-0009.2 G1020009
55200-67D11	B1.G120-1085.2 G1201085	04465-60320	B1.G120-5333.2 G1205333	171 698 151 G	B1.G102-0009.2 G1020009
55311-62J00	B1.G220-0211.1 G2120211	04465-74020	B1.G102-0714.2 G1020714	175 615 301	B1.G212-0106.1 G2112106
55810-62J00	B1.G120-1059.2 G1201059	04466-02020	B1.G102-0713.2 G1020713	175 698 151	B1.G102-0009.2 G1020009
55810-62J01	B1.G120-1059.2 G1201059	04466-02070	B1.G102-0713.2 G1020713	176 698 151	B1.G102-0009.2 G1020009
55810-62J20	B1.G120-1059.2 G1201059	04466-02160	B1.G102-0713.2 G1020713	191 615 601	B1.G210-0111.1 G2110111
55810-62J31	B1.G120-1059.2 G1201059	04466-02170	B1.G102-0768.2 G1020768	191 615 601 B	B1.G210-0111.1 G2110111
55810-62J50	B1.G120-1059.2 G1201059	04466-02180	B1.G102-0768.2 G1020768	191 698 151	B1.G102-0025.2 G1020025
55810-79J00	B1.G102-0774.2 G1020774	04466-02190	B1.G102-0768.2 G1020768	191 698 151 A	B1.G102-0025.2 G1020025
55810-79J10	B1.G102-0774.2 G1020774	04466-05010	B1.G102-0663.2 G1020663	191 698 151 B	B1.G102-0010.2 G1020010
55810-83E00	B1.G102-0605.2 G1020605	04466-05020	B1.G102-0663.2 G1020663	191 698 151 C	B1.G102-0009.2 G1020009
55810-84E01	B1.G102-0605.2 G1020605	04466-0D010	B1.G102-0666.2 G1020666	191 698 151 D	B1.G102-0009.2 G1020009
		04466-0F010	B1.G120-1209.2 G1201209	191 698 151 E	B1.G102-0025.2 G1020025
<b>TALBOT</b>		04466-12130	B1.G102-0975.2 G1020975	191 698 151 F	B1.G102-0025.2 G1020025
4248 61	B1.G102-0065.2 G1020065	04466-28110	B1.G102-0663.2 G1020663	191 698 151 G	B1.G102-0010.2 G1020010
4248 64	B1.G102-0065.2 G1020065	04466-33160	B1.G120-1022.2 G1201022	191 698 151 H	B1.G102-0009.2 G1020009
4250 67	B1.G102-0065.2 G1020065	04466-42060	B1.G120-1022.2 G1201022	191 698 151 J	B1.G102-0009.2 G1020009
		04466-47020	B1.G102-0975.2 G1020975	191 698 151 K	B1.G102-0009.2 G1020009
<b>TOYOTA</b>		04466-52120	B1.G102-0975.2 G1020975	191 698 451	B1.G102-0201.2 G1020201
04465-02061	B1.G102-0712.2 G1020712	04466-52140	B1.G102-0975.2 G1020975	191 698 451 A	B1.G102-0201.2 G1020201
04465-02130	B1.G102-0712.2 G1020712	04466-58010	B1.G102-0663.2 G1020663	191 698 451 B	B1.G102-0201.2 G1020201
04465-02160	B1.G102-0988.2 G1020988	04466-60010	B1.G120-5404.2 G1205404	191 698 451 C	B1.G102-0201.2 G1020201
04465-02200	B1.G102-0988.2 G1020988	04466-60020	B1.G120-5404.2 G1205404	191 698 451 D	B1.G102-0201.2 G1020201
04465-02210	B1.G102-0988.2 G1020988	04466-60080	B1.G120-5404.2 G1205404	1E0 698 451	B1.G102-0345.2 G1020345
04465-02370	B1.G102-0988.2 G1020988	04466-60090	B1.G120-5404.2 G1205404	1E0 698 451 A	B1.G102-0201.2 G1020201
04465-05130	B1.G102-0662.2 G1020662	04466-60140	B1.G120-5404.2 G1205404	1E0 698 451 B	B1.G102-0676.2 G1020676
04465-05131	B1.G102-0662.2 G1020662	04492-60010	B1.G120-5404.2 G1205404	1E0 698 451 C	B1.G102-0345.2 G1020345
04465-05170	B1.G102-0662.2 G1020662	04492-60020	B1.G120-5404.2 G1205404	1E0 698 451 D	B1.G102-0345.2 G1020345
04465-05210	B1.G102-0662.2 G1020662	42431-0D050	B1.G209-0139.1 G2109139	1E0 698 451 E	B1.G102-0345.2 G1020345
04465-0D010	B1.G102-0478.2 G1020478	42431-0D060	B1.G209-0142.1 G2109142	1E0 698 451 G	B1.G102-0345.2 G1020345
04465-0D040	B1.G102-0478.2 G1020478	42431-12210	B1.G209-0139.1 G2109139	1GD 698 151	B1.G102-0009.2 G1020009
04465-0D050	B1.G102-0798.2 G1020798	42431-12250	B1.G209-0139.1 G2109139	1H0 698 151	B1.G102-0009.2 G1020009
04465-0H020	B1.G102-0830.2 G1020830	42431-47020	B1.G209-0139.1 G2109139	1H0 698 151 A	B1.G102-0355.2 G1020355
04465-0W050	B1.G102-0714.2 G1020714	42431-52050	B1.G209-0139.1 G2109139	1H0 698 151 B	B1.G102-0390.2 G1020390
04465-12610	B1.G120-1065.2 G1201065	43512-02070	B1.G225-0155.1 G2125155	1H0 698 451	B1.G102-0345.2 G1020345
04465-13020	B1.G102-0714.2 G1020714	43512-0D010	B1.G218-0131.1 G2118131	1H0 698 451 A	B1.G102-0345.2 G1020345
04465-13050	B1.G102-0714.2 G1020714	43512-0D050	B1.G220-0175.1 G2120175	1H0 698 451 B	B1.G102-0201.2 G1020201
04465-17100	B1.G102-0714.2 G1020714	43512-0D060	B1.G222-0240.1 G2122240	1H0 698 451 C	B1.G102-0201.2 G1020201
04465-17101	B1.G102-0714.2 G1020714	43512-0H010	B1.G220-0180.1 G2120180	1H0 698 451 D	B1.G102-0345.2 G1020345
04465-17140	B1.G102-0714.2 G1020714	43512-0H020	B1.G220-0180.1 G2120180	1H0 698 451 E	B1.G102-0201.2 G1020201
04465-33240	B1.G120-5242.2 G1205242	43512-13030	B1.G225-0155.1 G2125155	1H0 698 451 F	B1.G102-0201.2 G1020201
04465-33250	B1.G120-5242.2 G1205242	43512-17120	B1.G220-0175.1 G2120175	1H0 698 451 G	B1.G102-0345.2 G1020345
04465-33260	B1.G120-5242.2 G1205242	43512-17130	B1.G220-0175.1 G2120175	1H0 698 451 H	B1.G102-0201.2 G1020201
04465-33320	B1.G120-5242.2 G1205242	43512-17131	B1.G220-0175.1 G2120175	1HM 698 151	B1.G102-0444.2 G1020444
04465-33340	B1.G120-5242.2 G1205242	43512-20470	B1.G225-0124.1 G2125124	1HM 698 151 A	B1.G102-0444.2 G1020444
04465-35290	B1.G120-5333.2 G1205333	43512-20480	B1.G225-0124.1 G2125124	1J0 615 301 C	B1.G225-0113.1 G2125113
04465-42140	B1.G102-0994.2 G1020994	43512-20580	B1.G225-0124.1 G2125124	1J0 615 301 D	B1.G222-0151.1 G2122151
04465-42150	B1.G102-0994.2 G1020994	43512-20700	B1.G225-0124.1 G2125124	1J0 615 301 E	B1.G222-0150.1 G2122150

# Cross reference list

Liste des correspondances / Tabella di conversione codici / Lista de comparação /



Lista porównawcza numerów / Porovnávací seznam čísel

VAG		VAG		VAG	
1J0 615 301 K	<b>B1.G225-0113.1 G2125113</b>	1K0 698 151 D	<b>B1.G102-0463.2 G1020463</b>	3B0 698 451	<b>B1.G102-0492.2 G1020492</b>
1J0 615 301 L	<b>B1.G222-0151.1 G2122151</b>	1K0 698 151 E	<b>B1.G102-0680.2 G1020680</b>	3B0 698 451 A	<b>B1.G102-0492.2 G1020492</b>
1J0 615 301 M	<b>B1.G222-0150.1 G2122150</b>	1K0 698 151 F	<b>B1.G102-0463.2 G1020463</b>	3B7 698 151	<b>B1.G102-0683.2 G1020683</b>
1J0 615 301 P	<b>B1.G222-0150.1 G2122150</b>	1K0 698 151 J	<b>B1.G102-0463.2 G1020463</b>	3C0 698 151	<b>B1.G102-0680.2 G1020680</b>
1J0 615 301 R	<b>B1.G225-0113.1 G2125113</b>	1K0 698 451	<b>B1.G102-0682.2 G1020682</b>	3C0 698 151 A	<b>B1.G102-0680.2 G1020680</b>
1J0 615 301 S	<b>B1.G225-0113.1 G2125113</b>	1K0 698 451 A	<b>B1.G102-0492.2 G1020492</b>	3C0 698 151 B	<b>B1.G102-0680.2 G1020680</b>
1J0 615 601	<b>B1.G209-0123.1 G2109123</b>	1K0 698 451 B	<b>B1.G102-0682.2 G1020682</b>	3C0 698 151 C	<b>B1.G102-0680.2 G1020680</b>
1J0 615 601 C	<b>B1.G209-0123.1 G2109123</b>	1K0 698 451 C	<b>B1.G102-0492.2 G1020492</b>	3C0 698 151 D	<b>B1.G102-0680.2 G1020680</b>
1J0 615 601 D	<b>B1.G209-0133.1 G2109133</b>	1K0 698 451 D	<b>B1.G102-0682.2 G1020682</b>	3C0 698 451	<b>B1.G102-0682.2 G1020682</b>
1J0 615 601 N	<b>B1.G209-0123.1 G2109123</b>	1K0 698 451 E	<b>B1.G102-0682.2 G1020682</b>	3C0 698 451 A	<b>B1.G102-0734.2 G1020734</b>
1J0 615 601 P	<b>B1.G209-0123.1 G2109123</b>	1K0 698 451 F	<b>B1.G102-0682.2 G1020682</b>	3C0 698 451 B	<b>B1.G102-0682.2 G1020682</b>
1J0 698 151	<b>B1.G102-0331.2 G1020331</b>	1K0 698 451 G	<b>B1.G102-0682.2 G1020682</b>	3C0 698 451 C	<b>B1.G102-0734.2 G1020734</b>
1J0 698 151 A	<b>B1.G102-0331.2 G1020331</b>	1K0 698 451 H	<b>B1.G102-0682.2 G1020682</b>	3C0 698 451 D	<b>B1.G102-0993.2 G1020993</b>
1J0 698 151 B	<b>B1.G102-0331.2 G1020331</b>	1K0 698 451 J	<b>B1.G102-0492.2 G1020492</b>	3C0 698 451 E	<b>B1.G102-0993.2 G1020993</b>
1J0 698 151 C	<b>B1.G102-0331.2 G1020331</b>	1K0 698 451 K	<b>B1.G102-0682.2 G1020682</b>	3C0 698 451 F	<b>B1.G102-0993.2 G1020993</b>
1J0 698 151 D	<b>B1.G102-0463.2 G1020463</b>	1K0 698 451 M	<b>B1.G102-0492.2 G1020492</b>	3D0 615 301 F	<b>B1.G234-0100.1 G2134100</b>
1J0 698 151 E	<b>B1.G102-0463.2 G1020463</b>	2D0 615 301 A	<b>B1.G222-0161.1 G2122161</b>	3D0 615 301 M	<b>B1.G234-0100.1 G2134100</b>
1J0 698 151 F	<b>B1.G102-0463.2 G1020463</b>	2D0 615 301 B	<b>B1.G222-0161.1 G2122161</b>	431 698 151 D	<b>B1.G102-0196.2 G1020196</b>
1J0 698 151 G	<b>B1.G102-0463.2 G1020463</b>	2D0 615 301 C	<b>B1.G222-0161.1 G2122161</b>	431 698 151 F	<b>B1.G102-0196.2 G1020196</b>
1J0 698 151 J	<b>B1.G102-0331.2 G1020331</b>	2D0 615 301 D	<b>B1.G222-0161.1 G2122161</b>	431 698 151 G	<b>B1.G102-0196.2 G1020196</b>
1J0 698 151 K	<b>B1.G102-0512.2 G1020512</b>	2D0 698 151	<b>B1.G102-0742.2 G1020742</b>	437 698 151	<b>B1.G102-0196.2 G1020196</b>
1J0 698 151 L	<b>B1.G102-0379.2 G1020379</b>	2D0 698 151 A	<b>B1.G102-0891.2 G1020891</b>	437 698 451	<b>B1.G102-0246.2 G1020246</b>
1J0 698 151 M	<b>B1.G102-0512.2 G1020512</b>	2D0 698 151 B	<b>B1.G102-0891.2 G1020891</b>	443 615 601	<b>B1.G210-0178.1 G2110178</b>
1J0 698 451	<b>B1.G102-0755.2 G1020755</b>	2D0 698 451	<b>B1.G102-0397.2 G1020397</b>	443 698 151 A	<b>B1.G102-0197.2 G1020197</b>
1J0 698 451 B	<b>B1.G102-0755.2 G1020755</b>	2D0 698 451 A	<b>B1.G102-0396.2 G1020396</b>	443 698 151 C	<b>B1.G102-0197.2 G1020197</b>
1J0 698 451 C	<b>B1.G102-0676.2 G1020676</b>	2D0 698 451 B	<b>B1.G102-0583.2 G1020583</b>	443 698 151 D	<b>B1.G102-0197.2 G1020197</b>
1J0 698 451 D	<b>B1.G102-0755.2 G1020755</b>	2D0 698 451 C	<b>B1.G102-0396.2 G1020396</b>	443 698 151 F	<b>B1.G102-0196.2 G1020196</b>
1J0 698 451 E	<b>B1.G102-0755.2 G1020755</b>	2E0 615 301	<b>B1.G228-0203.1 G2128203</b>	443 698 151 F	<b>B1.G102-0197.2 G1020197</b>
1J0 698 451 F	<b>B1.G102-0755.2 G1020755</b>	2E0 698 151	<b>B1.G102-0769.2 G1020769</b>	443 698 151 G	<b>B1.G102-0197.2 G1020197</b>
1J0 698 451 G	<b>B1.G102-0676.2 G1020676</b>	2E0 698 151 A	<b>B1.G102-0770.2 G1020770</b>	443 698 151 J	<b>B1.G102-0197.2 G1020197</b>
1J0 698 451 H	<b>B1.G102-0492.2 G1020492</b>	2E0 698 151 B	<b>B1.G102-0769.2 G1020769</b>	443 698 151 K	<b>B1.G102-0197.2 G1020197</b>
1J0 698 451 J	<b>B1.G102-0755.2 G1020755</b>	2E0 698 451	<b>B1.G102-0766.2 G1020766</b>	443 698 451	<b>B1.G102-0246.2 G1020246</b>
1J0 698 451 K	<b>B1.G102-0676.2 G1020676</b>	2E0 698 451 A	<b>B1.G102-0940.2 G1020940</b>	443 698 451 A	<b>B1.G102-0246.2 G1020246</b>
1J0 698 451 L	<b>B1.G102-0492.2 G1020492</b>	2E0 698 451 B	<b>B1.G102-0940.2 G1020940</b>	443 698 451 B	<b>B1.G102-0246.2 G1020246</b>
1J0 698 451 N	<b>B1.G102-0755.2 G1020755</b>	321 615 301	<b>B1.G212-0106.1 G2112106</b>	443 698 451 C	<b>B1.G102-0246.2 G1020246</b>
1J0 698 451 P	<b>B1.G102-0755.2 G1020755</b>	321 615 301 A	<b>B1.G220-0123.1 G2120123</b>	447 698 451	<b>B1.G102-0246.2 G1020246</b>
1J0 698 451 R	<b>B1.G102-0755.2 G1020755</b>	321 615 301 B	<b>B1.G220-0123.1 G2120123</b>	447 698 451 A	<b>B1.G102-0246.2 G1020246</b>
1JD 698 451	<b>B1.G102-0755.2 G1020755</b>	321 615 301 C	<b>B1.G220-0123.1 G2120123</b>	447 698 451 C	<b>B1.G102-0246.2 G1020246</b>
1K0 615 301 AA	<b>B1.G225-0158.1 G2125158</b>	321 615 301 D	<b>B1.G220-0128.1 G2120128</b>	4A0 615 301 B	<b>B1.G215-0105.1 G2115105</b>
1K0 615 301 AB	<b>B1.G230-0115.1 G2130115</b>	321 698 151	<b>B1.G102-0009.2 G1020009</b>	4A0 615 301 C	<b>B1.G225-0105.1 G2125105</b>
1K0 615 301 AC	<b>B1.G222-0210.1 G2122210</b>	321 698 151 B	<b>B1.G102-0010.2 G1020010</b>	4A0 615 301 D	<b>B1.G225-0105.1 G2125105</b>
1K0 615 301 AK	<b>B1.G222-0210.1 G2122210</b>	321 698 151 C	<b>B1.G102-0009.2 G1020009</b>	4A0 615 301 E	<b>B1.G225-0105.1 G2125105</b>
1K0 615 301 K	<b>B1.G225-0145.1 G2125145</b>	321 698 151 D	<b>B1.G102-0010.2 G1020010</b>	4A0 615 601 A	<b>B1.G210-0201.1 G2110201</b>
1K0 615 301 M	<b>B1.G230-0115.1 G2130115</b>	321 698 151 E	<b>B1.G102-0010.2 G1020010</b>	4A0 698 151	<b>B1.G102-0311.2 G1020311</b>
1K0 615 301 S	<b>B1.G222-0210.1 G2122210</b>	321 698 151 F	<b>B1.G102-0009.2 G1020009</b>	4A0 698 151 C	<b>B1.G102-0311.2 G1020311</b>
1K0 615 301 T	<b>B1.G225-0145.1 G2125145</b>	321 698 151 G	<b>B1.G102-0009.2 G1020009</b>	4A0 698 451	<b>B1.G102-0246.2 G1020246</b>
1K0 615 601 AA	<b>B1.G210-0356.1 G2110356</b>	321 698 151 H	<b>B1.G102-0010.2 G1020010</b>	4A0 615 301 A	<b>B1.G225-0137.1 G2125137</b>
1K0 615 601 AB	<b>B1.G210-0277.1 G2110277</b>	357 615 301	<b>B1.G213-0178.1 G2113178</b>	4B0 615 301 B	<b>B1.G225-0171.1 G2125171</b>
1K0 615 601 AC	<b>B1.G212-0158.1 G2112158</b>	357 615 601	<b>B1.G210-0111.1 G2110111</b>	4B0 615 601	<b>B1.G210-0258.1 G2110258</b>
1K0 615 601 AD	<b>B1.G212-0169.1 G2112169</b>	357 698 151	<b>B1.G102-0274.2 G1020274</b>	4B0 698 151	<b>B1.G102-0313.2 G1020313</b>
1K0 615 601 K	<b>B1.G210-0277.1 G2110277</b>	357 698 151 A	<b>B1.G102-0273.2 G1020273</b>	4B0 698 151 A	<b>B1.G102-0313.2 G1020313</b>
1K0 615 601 L	<b>B1.G212-0158.1 G2112158</b>	357 698 151 B	<b>B1.G102-0274.2 G1020274</b>	4B0 698 151 AB	<b>B1.G102-0313.2 G1020313</b>
1K0 615 601 M	<b>B1.G212-0169.1 G2112169</b>	357 698 151 D	<b>B1.G102-0273.2 G1020273</b>	4B0 698 151 AC	<b>B1.G102-0644.2 G1020644</b>
1K0 698 151	<b>B1.G102-0680.2 G1020680</b>	357 698 151 E	<b>B1.G102-0444.2 G1020444</b>	4B0 698 151 AD	<b>B1.G102-0644.2 G1020644</b>
1K0 698 151 A	<b>B1.G102-0463.2 G1020463</b>	3A0 698 151	<b>B1.G102-0379.2 G1020379</b>	4B0 698 151 AF	<b>B1.G102-0313.2 G1020313</b>
1K0 698 151 B	<b>B1.G102-0753.2 G1020753</b>	3A0 698 151 A	<b>B1.G102-0379.2 G1020379</b>	4B0 698 151 B	<b>B1.G102-0313.2 G1020313</b>
1K0 698 151 C	<b>B1.G102-0680.2 G1020680</b>	3B0 615 301 B	<b>B1.G225-0137.1 G2125137</b>	4B0 698 151 E	<b>B1.G102-0313.2 G1020313</b>

# Cross reference list

Liste des correspondances / Tabella di conversione codici / Lista de comparação /

Lista porównawcza numerów / Porovnávací seznam čísel

VAG		VAG		VAG	
4B0 698 151 H	B1.G102-0313.2 G1020313	6N0 615 301 D	B1.G220-0128.1 G2120128	7H0 698 151	B1.G102-0707.2 G1020707
4B0 698 151 J	B1.G102-0313.2 G1020313	6N0 615 301 F	B1.G218-0106.1 G2118106	7H0 698 151 A	B1.G102-0706.2 G1020706
4B0 698 151 K	B1.G102-0313.2 G1020313	6N0 615 601	B1.G210-0111.1 G2110111	7H0 698 151 B	B1.G102-0707.2 G1020707
4B0 698 151 M	B1.G102-0313.2 G1020313	6N0 615 601 A	B1.G209-0124.1 G2109124	7H0 698 151 C	B1.G102-0706.2 G1020706
4B0 698 151 N	B1.G102-0313.2 G1020313	6N0 615 601 B	B1.G209-0124.1 G2109124	7H0 698 451	B1.G102-0691.2 G1020691
4B0 698 151 Q	B1.G102-0644.2 G1020644	6N0 698 151	B1.G102-0408.2 G1020408	7H0 698 451 A	B1.G102-0759.2 G1020759
4B0 698 151 R	B1.G102-0644.2 G1020644	6N0 698 151 A	B1.G102-0444.2 G1020444	7H0 698 451 B	B1.G102-0691.2 G1020691
4B0 698 451	B1.G102-0492.2 G1020492	6N0 698 151 B	B1.G102-0444.2 G1020444	7H8 698 451	B1.G102-0699.2 G1020699
4B0 698 451 A	B1.G102-0492.2 G1020492	6N0 698 151 C	B1.G102-0408.2 G1020408	7L0 698 151 D	B1.G102-0709.2 G1020709
4B0 698 451 B	B1.G102-0492.2 G1020492	6Q0 615 301	B1.G218-0137.1 G2118137	7L0 698 151 E	B1.G102-0710.2 G1020710
4B0 698 451 E	B1.G102-0492.2 G1020492	6Q0 615 301 A	B1.G218-0137.1 G2118137	7L0 698 151 F	B1.G102-0709.2 G1020709
4B3 698 451	B1.G102-0759.2 G1020759	6Q0 698 151	B1.G102-0331.2 G1020331	7L0 698 151 G	B1.G102-0710.2 G1020710
4B3 698 451 A	B1.G102-0759.2 G1020759	6Q0 698 151 A	B1.G102-0732.2 G1020732	7L0 698 151 H	B1.G102-0709.2 G1020709
4D0 698 451	B1.G102-0246.2 G1020246	6Q0 698 151 B	B1.G102-0409.2 G1020409	7L0 698 151 J	B1.G102-0710.2 G1020710
4D0 698 451 A	B1.G102-0246.2 G1020246	6Q0 698 151 C	B1.G102-0733.2 G1020733	7L0 698 151 M	B1.G120-1079.2 G1201079
4D0 698 451 B	B1.G102-0246.2 G1020246	6Q0 698 451	B1.G102-0566.2 G1020566	7L0 698 151 N	B1.G120-1079.2 G1201079
4D0 698 451 C	B1.G102-0492.2 G1020492	6Q0 698 451 B	B1.G102-0566.2 G1020566	7L0 698 151 P	B1.G102-0710.2 G1020710
4D0 698 451 F	B1.G102-0246.2 G1020246	6R0 615 301	B1.G222-0151.1 G2122151	7L0 698 151 Q	B1.G102-0709.2 G1020709
4D0 698 451 G	B1.G102-0246.2 G1020246	6R0 615 301 A	B1.G225-0113.1 G2125113	7L0 698 451 A	B1.G102-0711.2 G1020711
4E0 615 301 A	B1.G234-0100.1 G2134100	6R0 615 301 B	B1.G225-0123.1 G2125123	7L0 698 451 B	B1.G102-0711.2 G1020711
4E0 615 301 G	B1.G234-0100.1 G2134100	6R0 698 151 A	B1.G102-0331.2 G1020331	7L0 698 451 C	B1.G102-0999.2 G1020999
4E0 615 301 J	B1.G234-0100.1 G2134100	6U0 615 301	B1.G213-0182.1 G2113182	7L0 698 451 D	B1.G102-0999.2 G1020999
4E0 615 301 P	B1.G234-0100.1 G2134100	6X0 698 451	B1.G102-0549.2 G1020549	7L0 698 451 E	B1.G102-0999.2 G1020999
4E0 698 151	B1.G102-0678.2 G1020678	6X0 698 451 A	B1.G102-0549.2 G1020549	7L0 698 451 F	B1.G102-0999.2 G1020999
4E0 698 151 A	B1.G102-0678.2 G1020678	701 615 601 A	B1.G212-0138.1 G2112138	7L0 698 451 G	B1.G102-0711.2 G1020711
4E0 698 151 B	B1.G102-0678.2 G1020678	701 698 151	B1.G102-0304.2 G1020304	7L5 698 451	B1.G102-0711.2 G1020711
4E0 698 151 E	B1.G102-0678.2 G1020678	701 698 151 B	B1.G102-0315.2 G1020315	7L6 698 151	B1.G102-0709.2 G1020709
4E0 698 151 F	B1.G102-0754.2 G1020754	701 698 151 C	B1.G102-0304.2 G1020304	7L6 698 151 A	B1.G102-0710.2 G1020710
4E0 698 151 J	B1.G102-0678.2 G1020678	701 698 151 D	B1.G102-0347.2 G1020347	7L6 698 151 B	B1.G102-0704.2 G1020704
4E0 698 151 K	B1.G102-0678.2 G1020678	701 698 151 E	B1.G102-0347.2 G1020347	7L6 698 151 C	B1.G102-0709.2 G1020709
4E0 698 151 M	B1.G102-0754.2 G1020754	701 698 151 F	B1.G102-0315.2 G1020315	7L6 698 151 D	B1.G102-0710.2 G1020710
4F0 615 301 D	B1.G225-0149.1 G2125149	701 698 151 G	B1.G102-0315.2 G1020315	7L6 698 151 E	B1.G120-1010.2 G1201010
4F0 615 301 E	B1.G230-0175.1 G2130175	701 698 151 H	B1.G102-0315.2 G1020315	7L6 698 151 G	B1.G120-1010.2 G1201010
4F0 615 301 G	B1.G230-0176.1 G2130176	701 698 151 J	B1.G102-0347.2 G1020347	7L6 698 451	B1.G102-0698.2 G1020698
4F0 698 151	B1.G102-0313.2 G1020313	701 698 451	B1.G102-0658.2 G1020658	7L6 698 451 A	B1.G102-0711.2 G1020711
4F0 698 151 A	B1.G102-0754.2 G1020754	7D0 615 601	B1.G212-0138.1 G2112138	7L6 698 451 B	B1.G120-1011.2 G1201011
4F0 698 151 D	B1.G102-0754.2 G1020754	7D0 615 601 B	B1.G212-0138.1 G2112138	7L6 698 451 D	B1.G102-0711.2 G1020711
4F0 698 451	B1.G102-0758.2 G1020758	7D0 698 151	B1.G102-0419.2 G1020419	7M0 615 301 E	B1.G225-0114.1 G2125114
4F0 698 451 A	B1.G102-0682.2 G1020682	7D0 698 151 A	B1.G102-0527.2 G1020527	7M0 615 301 G	B1.G225-0114.1 G2125114
4F0 698 451 B	B1.G102-0682.2 G1020682	7D0 698 151 B	B1.G102-0524.2 G1020524	7M0 615 601 A	B1.G210-0223.1 G2110223
4F0 698 451 C	B1.G102-0758.2 G1020758	7D0 698 151 C	B1.G102-0533.2 G1020533	7M0 615 601 B	B1.G210-0223.1 G2110223
4F0 698 451 D	B1.G102-0682.2 G1020682	7D0 698 151 D	B1.G102-0534.2 G1020534	7M0 615 601 C	B1.G210-0223.1 G2110223
4F0 698 451 E	B1.G102-0682.2 G1020682	7D0 698 151 E	B1.G102-0419.2 G1020419	7M0 698 151	B1.G102-0312.2 G1020312
4F0 698 451 F	B1.G102-0758.2 G1020758	7D0 698 151 F	B1.G102-0534.2 G1020534	7M0 698 151 A	B1.G102-0312.2 G1020312
4F0 698 451 G	B1.G102-0758.2 G1020758	7D0 698 151 G	B1.G102-0524.2 G1020524	7M0 698 151 B	B1.G102-0312.2 G1020312
533 698 151 A	B1.G102-0273.2 G1020273	7D0 698 151 H	B1.G102-0533.2 G1020533	7M0 698 451	B1.G102-0549.2 G1020549
5C0 615 301	B1.G222-0210.1 G2122210	7D0 698 451	B1.G102-0658.2 G1020658	7M3 698 151	B1.G102-0557.2 G1020557
5C0 615 301 A	B1.G225-0145.1 G2125145	7D0 698 451 A	B1.G102-0658.2 G1020658	7M3 698 151 A	B1.G102-0580.2 G1020580
5C0 615 301 B	B1.G225-0158.1 G2125158	7D0 698 451 B	B1.G102-0654.2 G1020654	7M3 698 151 B	B1.G102-0593.2 G1020593
5C0 698 151	B1.G102-0331.2 G1020331	7D0 698 451 C	B1.G102-0654.2 G1020654	7M3 698 451	B1.G102-0564.2 G1020564
5K0 698 151	B1.G102-0680.2 G1020680	7D0 698 451 D	B1.G102-0658.2 G1020658	7M3 698 451 A	B1.G102-0549.2 G1020549
5K0 698 151 A	B1.G102-0680.2 G1020680	7D0 698 451 E	B1.G102-0658.2 G1020658	7M3 698 451 B	B1.G102-0564.2 G1020564
5N0 698 151	B1.G102-0992.2 G1020992	7D0 698 451 F	B1.G102-0654.2 G1020654	7M3 698 451 C	B1.G102-0564.2 G1020564
5N0 698 151 A	B1.G102-0992.2 G1020992	7D0 698 451 G	B1.G102-0658.2 G1020658	7M3 698 451 D	B1.G102-0654.2 G1020654
5N0 698 451	B1.G102-0993.2 G1020993	7D0 698 451 J	B1.G102-0658.2 G1020658	7M3 698 451 E	B1.G102-0564.2 G1020564
6N0 615 301	B1.G210-0232.1 G2110232	7H0 615 301 D	B1.G230-0114.1 G2130114	7M3 698 451 F	B1.G102-0654.2 G1020654
6N0 615 301 C	B1.G218-0106.1 G2118106	7H0 615 601 B	B1.G222-0211.1 G2122211	7N0 698 151	B1.G102-0992.2 G1020992

# Cross reference list

Liste des correspondances / Tabella di conversione codici / Lista de comparação /

Lista porównawcza numerów / Porovnávací seznam čísel

VAG		VAG		VOLVO	
7P0 698 151	B1.G120-1079.2 G1201079	8E0 698 451 C	B1.G102-0758.2 G1020758	274285	B1.G102-0694.2 G1020694
7P0 698 151 B	B1.G120-1079.2 G1201079	8E0 698 451 D	B1.G102-0676.2 G1020676	274331	B1.G102-0696.2 G1020696
7P0 698 151 C	B1.G120-1079.2 G1201079	8E0 698 451 E	B1.G102-0676.2 G1020676	274334	B1.G102-0480.2 G1020480
7P6 698 151	B1.G120-1079.2 G1201079	8E0 698 451 F	B1.G102-0682.2 G1020682	274335	B1.G102-0578.2 G1020578
7P6 698 151 B	B1.G120-1079.2 G1201079	8E0 698 451 J	B1.G102-0682.2 G1020682	274509	B1.G225-0117.1 G2125117
811 615 301	B1.G210-0151.1 G2110151	8E0 698 451 K	B1.G102-0492.2 G1020492	274510	B1.G225-0162.1 G2125162
811 698 151	B1.G102-0097.2 G1020097	8E0 698 451 L	B1.G102-0676.2 G1020676	3345670	B1.G102-0457.2 G1020457
823 615 301	B1.G210-0151.1 G2110151	8E0 698 451 M	B1.G102-0682.2 G1020682	3345678	B1.G102-0458.2 G1020458
823 698 151	B1.G102-0097.2 G1020097	8E0 698 451 N	B1.G102-0758.2 G1020758	8623861	B1.G102-0578.2 G1020578
823 698 151 A	B1.G102-0097.2 G1020097	8J0 698 151 A	B1.G102-0895.2 G1020895	8623862	B1.G102-0480.2 G1020480
839 615 301	B1.G212-0106.1 G2112106	8J0 698 151 E	B1.G120-1010.2 G1201010	8628240	B1.G102-0510.2 G1020510
841 615 301	B1.G220-0123.1 G2120123	8J0 698 151 F	B1.G102-0895.2 G1020895	8634921	B1.G102-0578.2 G1020578
857 698 451	B1.G102-0246.2 G1020246	8J0 698 151 G	B1.G120-1010.2 G1201010	8634925	B1.G102-0480.2 G1020480
861 698 151	B1.G102-0097.2 G1020097	8K0 615 301	B1.G225-0184.1 G2125184	8683615	B1.G102-0727.2 G1020727
861 698 151 A	B1.G102-0097.2 G1020097	8K0 615 601 B	B1.G212-0178.1 G2112178	9485267	B1.G102-0956.2 G1020956
867 698 151	B1.G102-0344.2 G1020344	8K0 698 151	B1.G102-0983.2 G1020983	9485593	B1.G102-0956.2 G1020956
895 615 601 A	B1.G210-0261.1 G2110261	8K0 698 151 A	B1.G102-0823.2 G1020823	30620770	B1.G102-0458.2 G1020458
8A0 698 151	B1.G102-0196.2 G1020196	8K0 698 151 B	B1.G102-0983.2 G1020983	30623259	B1.G102-0537.2 G1020537
8A0 698 151 A	B1.G102-0196.2 G1020196	8K0 698 151 E	B1.G102-0983.2 G1020983	30623264	B1.G102-0458.2 G1020458
8A0 698 151 B	B1.G102-0196.2 G1020196	8K0 698 151 F	B1.G102-0823.2 G1020823	30648381	B1.G102-0956.2 G1020956
8A0 698 151 C	B1.G102-0196.2 G1020196	8K0 698 151 G	B1.G102-0983.2 G1020983	30648382	B1.G102-0480.2 G1020480
8A0 698 151 E	B1.G102-0196.2 G1020196	8K0 698 151 H	B1.G102-0983.2 G1020983	30648385	B1.G102-0578.2 G1020578
8D0 615 301 A	B1.G213-0181.1 G2113181	8K0 698 151 K	B1.G102-0983.2 G1020983	30648387	B1.G102-0578.2 G1020578
8D0 615 301 J	B1.G225-0137.1 G2125137	8K0 698 451	B1.G120-1005.2 G1201005	30666802	B1.G211-0158.1 G2111158
8D0 615 301 K	B1.G230-0113.1 G2130113	8K0 698 451 A	B1.G120-1004.2 G1201004	30671574	B1.G102-0900.2 G1020900
8D0 615 301 M	B1.G230-0113.1 G2130113	8K0 698 451 B	B1.G120-1004.2 G1201004	30671575	B1.G102-0787.2 G1020787
8D0 615 601 B	B1.G210-0210.1 G2110210	8K0 698 451 C	B1.G120-1004.2 G1201004	30671576	B1.G120-1135.2 G1201135
8D0 698 151	B1.G102-0196.2 G1020196	8K0 698 451 D	B1.G120-1005.2 G1201005	30681739	B1.G102-0622.2 G1020622
8D0 698 151 A	B1.G102-0312.2 G1020312	8L0 615 301	B1.G225-0123.1 G2125123	30683274	B1.G102-0772.2 G1020772
8D0 698 151 C	B1.G102-0312.2 G1020312	8L0 615 601	B1.G222-0163.1 G2122163	30683554	B1.G102-0622.2 G1020622
8D0 698 151 D	B1.G102-0683.2 G1020683	8N0 615 301 A	B1.G225-0123.1 G2125123	30714791	B1.G102-0772.2 G1020772
8D0 698 151 F	B1.G102-0312.2 G1020312	8N0 615 601 B	B1.G222-0163.1 G2122163	30715023	B1.G102-0622.2 G1020622
8D0 698 151 L	B1.G102-0196.2 G1020196	8N0 698 151	B1.G102-0379.2 G1020379	30736322	B1.G120-1009.2 G1201009
8E0 615 301 A	B1.G225-0115.1 G2125115	8N0 698 151 A	B1.G102-0512.2 G1020512	30736610	B1.G102-0727.2 G1020727
8E0 615 301 AD	B1.G230-0113.1 G2130113	8N0 698 151 D	B1.G102-0683.2 G1020683	30736923	B1.G102-0622.2 G1020622
8E0 615 301 B	B1.G222-0152.1 G2122152	8P0 698 151	B1.G102-0895.2 G1020895	30742029	B1.G102-0772.2 G1020772
8E0 615 301 C	B1.G225-0115.1 G2125115	8R0 698 151	B1.G102-0983.2 G1020983	30742030	B1.G102-0622.2 G1020622
8E0 615 301 D	B1.G222-0152.1 G2122152	8Z0 615 301 B	B1.G222-0151.1 G2122151	30742031	B1.G102-0727.2 G1020727
8E0 615 301 P	B1.G222-0152.1 G2122152	8Z0 615 301 D	B1.G222-0151.1 G2122151	30742490	B1.G120-1135.2 G1201135
8E0 615 301 Q	B1.G225-0105.1 G2125105	8Z0 698 151 A	B1.G102-0463.2 G1020463	30742491	B1.G102-0900.2 G1020900
8E0 615 301 R	B1.G225-0137.1 G2125137	JZW 698 151	B1.G102-0463.2 G1020463	30742516	B1.G102-0787.2 G1020787
8E0 615 601	B1.G210-0201.1 G2110201	JZW 698 151 A	B1.G102-0331.2 G1020331	30769056	B1.G228-0154.1 G2128154
8E0 615 601 B	B1.G210-0261.1 G2110261	JZW 698 451 A	B1.G102-0755.2 G1020755	30769113	B1.G211-0158.1 G2111158
8E0 615 601 P	B1.G210-0261.1 G2110261			30793107	B1.G102-0889.2 G1020889
8E0 698 151	B1.G102-0421.2 G1020421			30793265	B1.G102-0694.2 G1020694
8E0 698 151 A	B1.G102-0196.2 G1020196	<b>VOLVO</b>		30793539	B1.G120-1009.2 G1201009
8E0 698 151 A	B1.G102-0421.2 G1020421	270923	B1.G102-0955.2 G1020955	30793540	B1.G102-0889.2 G1020889
8E0 698 151 B	B1.G102-0511.2 G1020511	271573	B1.G102-0955.2 G1020955	30793618	B1.G102-0622.2 G1020622
8E0 698 151 C	B1.G102-0754.2 G1020754	271587	B1.G102-0956.2 G1020956	30793799	B1.G102-0956.2 G1020956
8E0 698 151 F	B1.G102-0313.2 G1020313	271829	B1.G102-0955.2 G1020955	30793857	B1.G120-1009.2 G1201009
8E0 698 151 G	B1.G102-0754.2 G1020754	271859	B1.G102-0956.2 G1020956	30793941	B1.G102-0889.2 G1020889
8E0 698 151 K	B1.G102-0313.2 G1020313	271958	B1.G102-0955.2 G1020955	30794553	B1.G120-1135.2 G1201135
8E0 698 151 M	B1.G102-0511.2 G1020511	272291	B1.G102-0955.2 G1020955	30794554	B1.G102-0900.2 G1020900
8E0 698 151 N	B1.G102-0421.2 G1020421	272343	B1.G102-0956.2 G1020956	30794555	B1.G102-0787.2 G1020787
8E0 698 451	B1.G102-0492.2 G1020492	272399	B1.G102-0480.2 G1020480	30794555	B1.G102-0537.2 G1020537
8E0 698 451 A	B1.G102-0492.2 G1020492	272401	B1.G102-0578.2 G1020578	30850976	B1.G102-0458.2 G1020458
8E0 698 451 B	B1.G102-0559.2 G1020559	272407	B1.G102-0510.2 G1020510	30850978	B1.G210-0229.1 G2110229
		272944	B1.G102-0480.2 G1020480	30872940	



# Cross reference list

Liste des correspondances / Tabella di conversione codici / Lista de comparação /

Lista porównawcza numerów / Porovnávací seznam čísel









**VOLVO**



31200229	B1.G120-1009.2	G1201009
31202331	B1.G228-0154.1	G2128154
31262705	B1.G102-0696.2	G1020696
31262718	B1.G225-0117.1	G2125117
31262719	B1.G225-0162.1	G2125162
31317482	B1.G102-0787.2	G1020787
31341645	B1.G211-0158.1	G2111158

# Cross reference list GALFER short → GALFER long









Liste des correspondances GALFER courte → GALFER longue / Tabella di conversione codici GALFER breve → GALFER lungo / Lista de comparação GALFER curto → GALFER longo / Lista porównawcza numerów GALFER krótki → GALFER długo / Porovnávací seznam čísel GALFER krátký → GALFER dlouho

 short / courte breve / curto krótki / krátký	 long / longue lungo / longo dlugo / dlouho	 short / courte breve / curto krótki / krátký	 long / longue lungo / longo dlugo / dlouho	 short / courte breve / curto krótki / krátký	 long / longue lungo / longo dlugo / dlouho	 short / courte breve / curto krótki / krátký	 long / longue lungo / longo dlugo / dlouho
G102009	B1.G102-0009.2	G1020326	B1.G102-0326.2	G1020459	B1.G102-0459.2	G1020567	B1.G102-0567.2
G1020010	B1.G102-0010.2	G1020327	B1.G102-0327.2	G1020463	B1.G102-0463.2	G1020568	B1.G102-0568.2
G1020015	B1.G102-0015.2	G1020328	B1.G102-0328.2	G1020467	B1.G102-0467.2	G1020569	B1.G102-0569.2
G1020022	B1.G102-0022.2	G1020329	B1.G102-0329.2	G1020469	B1.G102-0469.2	G1020570	B1.G102-0570.2
G1020025	B1.G102-0025.2	G1020331	B1.G102-0331.2	G1020470	B1.G102-0470.2	G1020572	B1.G102-0572.2
G1020026	B1.G102-0026.2	G1020332	B1.G102-0332.2	G1020473	B1.G102-0473.2	G1020573	B1.G102-0573.2
G1020028	B1.G102-0028.2	G1020334	B1.G102-0334.2	G1020474	B1.G102-0474.2	G1020574	B1.G102-0574.2
G1020044	B1.G102-0044.2	G1020337	B1.G102-0337.2	G1020478	B1.G102-0478.2	G1020575	B1.G102-0575.2
G1020046	B1.G102-0046.2	G1020339	B1.G102-0339.2	G1020480	B1.G102-0480.2	G1020576	B1.G102-0576.2
G1020065	B1.G102-0065.2	G1020340	B1.G102-0340.2	G1020482	B1.G102-0482.2	G1020578	B1.G102-0578.2
G1020097	B1.G102-0097.2	G1020342	B1.G102-0342.2	G1020483	B1.G102-0483.2	G1020580	B1.G102-0580.2
G1020140	B1.G102-0140.2	G1020344	B1.G102-0344.2	G1020484	B1.G102-0484.2	G1020582	B1.G102-0582.2
G1020141	B1.G102-0141.2	G1020345	B1.G102-0345.2	G1020487	B1.G102-0487.2	G1020583	B1.G102-0583.2
G1020147	B1.G102-0147.2	G1020347	B1.G102-0347.2	G1020489	B1.G102-0489.2	G1020584	B1.G102-0584.2
G1020184	B1.G102-0184.2	G1020350	B1.G102-0350.2	G1020492	B1.G102-0492.2	G1020586	B1.G102-0586.2
G1020196	B1.G102-0196.2	G1020351	B1.G102-0351.2	G1020496	B1.G102-0496.2	G1020588	B1.G102-0588.2
G1020197	B1.G102-0197.2	G1020355	B1.G102-0355.2	G1020497	B1.G102-0497.2	G1020591	B1.G102-0591.2
G1020201	B1.G102-0201.2	G1020357	B1.G102-0357.2	G1020500	B1.G102-0500.2	G1020593	B1.G102-0593.2
G1020213	B1.G102-0213.2	G1020359	B1.G102-0359.2	G1020501	B1.G102-0501.2	G1020595	B1.G102-0595.2
G1020214	B1.G102-0214.2	G1020360	B1.G102-0360.2	G1020503	B1.G102-0503.2	G1020597	B1.G102-0597.2
G1020215	B1.G102-0215.2	G1020362	B1.G102-0362.2	G1020504	B1.G102-0504.2	G1020602	B1.G102-0602.2
G1020216	B1.G102-0216.2	G1020363	B1.G102-0363.2	G1020505	B1.G102-0505.2	G1020603	B1.G102-0603.2
G1020219	B1.G102-0219.2	G1020367	B1.G102-0367.2	G1020507	B1.G102-0507.2	G1020604	B1.G102-0604.2
G1020236	B1.G102-0236.2	G1020368	B1.G102-0368.2	G1020510	B1.G102-0510.2	G1020605	B1.G102-0605.2
G1020246	B1.G102-0246.2	G1020369	B1.G102-0369.2	G1020511	B1.G102-0511.2	G1020608	B1.G102-0608.2
G1020257	B1.G102-0257.2	G1020372	B1.G102-0372.2	G1020512	B1.G102-0512.2	G1020610	B1.G102-0610.2
G1020258	B1.G102-0258.2	G1020373	B1.G102-0373.2	G1020513	B1.G102-0513.2	G1020613	B1.G102-0613.2
G1020259	B1.G102-0259.2	G1020379	B1.G102-0379.2	G1020514	B1.G102-0514.2	G1020614	B1.G102-0614.2
G1020265	B1.G102-0265.2	G1020384	B1.G102-0384.2	G1020515	B1.G102-0515.2	G1020615	B1.G102-0615.2
G1020269	B1.G102-0269.2	G1020389	B1.G102-0389.2	G1020516	B1.G102-0516.2	G1020617	B1.G102-0617.2
G1020271	B1.G102-0271.2	G1020390	B1.G102-0390.2	G1020517	B1.G102-0517.2	G1020618	B1.G102-0618.2
G1020272	B1.G102-0272.2	G1020392	B1.G102-0392.2	G1020518	B1.G102-0518.2	G1020621	B1.G102-0621.2
G1020273	B1.G102-0273.2	G1020395	B1.G102-0395.2	G1020519	B1.G102-0519.2	G1020622	B1.G102-0622.2
G1020274	B1.G102-0274.2	G1020396	B1.G102-0396.2	G1020522	B1.G102-0522.2	G1020624	B1.G102-0624.2
G1020275	B1.G102-0275.2	G1020397	B1.G102-0397.2	G1020524	B1.G102-0524.2	G1020625	B1.G102-0625.2
G1020290	B1.G102-0290.2	G1020398	B1.G102-0398.2	G1020527	B1.G102-0527.2	G1020627	B1.G102-0627.2
G1020291	B1.G102-0291.2	G1020400	B1.G102-0400.2	G1020529	B1.G102-0529.2	G1020630	B1.G102-0630.2
G1020292	B1.G102-0292.2	G1020401	B1.G102-0401.2	G1020533	B1.G102-0533.2	G1020632	B1.G102-0632.2
G1020293	B1.G102-0293.2	G1020403	B1.G102-0403.2	G1020534	B1.G102-0534.2	G1020633	B1.G102-0633.2
G1020295	B1.G102-0295.2	G1020408	B1.G102-0408.2	G1020537	B1.G102-0537.2	G1020634	B1.G102-0634.2
G1020296	B1.G102-0296.2	G1020409	B1.G102-0409.2	G1020538	B1.G102-0538.2	G1020637	B1.G102-0637.2
G1020298	B1.G102-0298.2	G1020411	B1.G102-0411.2	G1020540	B1.G102-0540.2	G1020638	B1.G102-0638.2
G1020299	B1.G102-0299.2	G1020415	B1.G102-0415.2	G1020542	B1.G102-0542.2	G1020642	B1.G102-0642.2
G1020301	B1.G102-0301.2	G1020419	B1.G102-0419.2	G1020544	B1.G102-0544.2	G1020644	B1.G102-0644.2
G1020302	B1.G102-0302.2	G1020421	B1.G102-0421.2	G1020545	B1.G102-0545.2	G1020646	B1.G102-0646.2
G1020304	B1.G102-0304.2	G1020422	B1.G102-0422.2	G1020547	B1.G102-0547.2	G1020648	B1.G102-0648.2
G1020305	B1.G102-0305.2	G1020423	B1.G102-0423.2	G1020548	B1.G102-0548.2	G1020650	B1.G102-0650.2
G1020308	B1.G102-0308.2	G1020427	B1.G102-0427.2	G1020549	B1.G102-0549.2	G1020652	B1.G102-0652.2
G1020310	B1.G102-0310.2	G1020440	B1.G102-0440.2	G1020550	B1.G102-0550.2	G1020654	B1.G102-0654.2
G1020311	B1.G102-0311.2	G1020441	B1.G102-0441.2	G1020554	B1.G102-0554.2	G1020658	B1.G102-0658.2
G1020312	B1.G102-0312.2	G1020442	B1.G102-0442.2	G1020557	B1.G102-0557.2	G1020659	B1.G102-0659.2
G1020313	B1.G102-0313.2	G1020443	B1.G102-0443.2	G1020559	B1.G102-0559.2	G1020660	B1.G102-0660.2
G1020315	B1.G102-0315.2	G1020444	B1.G102-0444.2	G1020560	B1.G102-0560.2	G1020661	B1.G102-0661.2
G1020316	B1.G102-0316.2	G1020448	B1.G102-0448.2	G1020562	B1.G102-0562.2	G1020662	B1.G102-0662.2
G1020317	B1.G102-0317.2	G1020451	B1.G102-0451.2	G1020563	B1.G102-0563.2	G1020663	B1.G102-0663.2
G1020320	B1.G102-0320.2	G1020457	B1.G102-0457.2	G1020564	B1.G102-0564.2	G1020666	B1.G102-0666.2
G1020323	B1.G102-0323.2	G1020458	B1.G102-0458.2	G1020566	B1.G102-0566.2	G1020670	B1.G102-0670.2











# Cross reference list GALFER short → GALFER long

Liste des correspondances GALFER courte → GALFER longue / Tabella di conversione codici GALFER breve → GALFER lungo / Lista de comparação GALFER curto → GALFER longo / Lista porównawcza numerów GALFER krótki → GALFER długo / Porovnávací seznam čísel GALFER krátký → GALFER dlouho

 short / courte breve / curto krótki / krátky	 long / longue lungo / longo dlugo / dlouho	 short / courte breve / curto krótki / krátky	 long / longue lungo / longo dlugo / dlouho	 short / courte breve / curto krótki / krátky	 long / longue lungo / longo dlugo / dlouho	 short / courte breve / curto krótki / krátky	 long / longue lungo / longo dlugo / dlouho
G1020672	B1.G102-0672.2	G1020769	B1.G102-0769.2	G1020887	B1.G102-0887.2	G1201035	B1.G120-1035.2
G1020676	B1.G102-0676.2	G1020770	B1.G102-0770.2	G1020889	B1.G102-0889.2	G1201047	B1.G120-1047.2
G1020677	B1.G102-0677.2	G1020772	B1.G102-0772.2	G1020891	B1.G102-0891.2	G1201053	B1.G120-1053.2
G1020678	B1.G102-0678.2	G1020774	B1.G102-0774.2	G1020893	B1.G102-0893.2	G1201056	B1.G120-1056.2
G1020680	B1.G102-0680.2	G1020776	B1.G102-0776.2	G1020895	B1.G102-0895.2	G1201059	B1.G120-1059.2
G1020682	B1.G102-0682.2	G1020777	B1.G102-0777.2	G1020896	B1.G102-0896.2	G1201065	B1.G120-1065.2
G1020683	B1.G102-0683.2	G1020779	B1.G102-0779.2	G1020900	B1.G102-0900.2	G1201066	B1.G120-1066.2
G1020685	B1.G102-0685.2	G1020780	B1.G102-0780.2	G1020901	B1.G102-0901.2	G1201069	B1.G120-1069.2
G1020686	B1.G102-0686.2	G1020785	B1.G102-0785.2	G1020905	B1.G102-0905.2	G1201070	B1.G120-1070.2
G1020687	B1.G102-0687.2	G1020786	B1.G102-0786.2	G1020907	B1.G102-0907.2	G1201073	B1.G120-1073.2
G1020691	B1.G102-0691.2	G1020787	B1.G102-0787.2	G1020920	B1.G102-0920.2	G1201079	B1.G120-1079.2
G1020692	B1.G102-0692.2	G1020790	B1.G102-0790.2	G1020921	B1.G102-0921.2	G1201085	B1.G120-1085.2
G1020694	B1.G102-0694.2	G1020792	B1.G102-0792.2	G1020922	B1.G102-0922.2	G1201126	B1.G120-1126.2
G1020696	B1.G102-0696.2	G1020794	B1.G102-0794.2	G1020924	B1.G102-0924.2	G1201128	B1.G120-1128.2
G1020698	B1.G102-0698.2	G1020796	B1.G102-0796.2	G1020925	B1.G102-0925.2	G1201135	B1.G120-1135.2
G1020699	B1.G102-0699.2	G1020798	B1.G102-0798.2	G1020928	B1.G102-0928.2	G1201143	B1.G120-1143.2
G1020701	B1.G102-0701.2	G1020799	B1.G102-0799.2	G1020933	B1.G102-0933.2	G1201145	B1.G120-1145.2
G1020704	B1.G102-0704.2	G1020800	B1.G102-0800.2	G1020934	B1.G102-0934.2	G1201147	B1.G120-1147.2
G1020706	B1.G102-0706.2	G1020801	B1.G102-0801.2	G1020935	B1.G102-0935.2	G1201148	B1.G120-1148.2
G1020707	B1.G102-0707.2	G1020802	B1.G102-0802.2	G1020937	B1.G102-0937.2	G1201149	B1.G120-1149.2
G1020709	B1.G102-0709.2	G1020803	B1.G102-0803.2	G1020938	B1.G102-0938.2	G1201209	B1.G120-1209.2
G1020710	B1.G102-0710.2	G1020806	B1.G102-0806.2	G1020939	B1.G102-0939.2	G1201213	B1.G120-1213.2
G1020711	B1.G102-0711.2	G1020812	B1.G102-0812.2	G1020940	B1.G102-0940.2	G1201224	B1.G120-1224.2
G1020712	B1.G102-0712.2	G1020817	B1.G102-0817.2	G1020946	B1.G102-0946.2	G1201225	B1.G120-1225.2
G1020713	B1.G102-0713.2	G1020819	B1.G102-0819.2	G1020951	B1.G102-0951.2	G1201272	B1.G120-1272.2
G1020714	B1.G102-0714.2	G1020823	B1.G102-0823.2	G1020952	B1.G102-0952.2	G1205203	B1.G120-5203.2
G1020719	B1.G102-0719.2	G1020825	B1.G102-0825.2	G1020953	B1.G102-0953.2	G1205215	B1.G120-5215.2
G1020721	B1.G102-0721.2	G1020828	B1.G102-0828.2	G1020955	B1.G102-0955.2	G1205230	B1.G120-5230.2
G1020722	B1.G102-0722.2	G1020829	B1.G102-0829.2	G1020956	B1.G102-0956.2	G1205234	B1.G120-5234.2
G1020727	B1.G102-0727.2	G1020830	B1.G102-0830.2	G1020963	B1.G102-0963.2	G1205238	B1.G120-5238.2
G1020730	B1.G102-0730.2	G1020833	B1.G102-0833.2	G1020971	B1.G102-0971.2	G1205241	B1.G120-5241.2
G1020732	B1.G102-0732.2	G1020834	B1.G102-0834.2	G1020974	B1.G102-0974.2	G1205242	B1.G120-5242.2
G1020733	B1.G102-0733.2	G1020836	B1.G102-0836.2	G1020975	B1.G102-0975.2	G1205333	B1.G120-5333.2
G1020734	B1.G102-0734.2	G1020844	B1.G102-0844.2	G1020979	B1.G102-0979.2	G1205344	B1.G120-5344.2
G1020735	B1.G102-0735.2	G1020846	B1.G102-0846.2	G1020981	B1.G102-0981.2	G1205352	B1.G120-5352.2
G1020737	B1.G102-0737.2	G1020848	B1.G102-0848.2	G1020983	B1.G102-0983.2	G1205366	B1.G120-5366.2
G1020738	B1.G102-0738.2	G1020850	B1.G102-0850.2	G1020985	B1.G102-0985.2	G1205404	B1.G120-5404.2
G1020740	B1.G102-0740.2	G1020852	B1.G102-0852.2	G1020987	B1.G102-0987.2	G1205418	B1.G120-5418.2
G1020741	B1.G102-0741.2	G1020855	B1.G102-0855.2	G1020988	B1.G102-0988.2	G2107109	B1.G207-0109.1
G1020742	B1.G102-0742.2	G1020856	B1.G102-0856.2	G1020992	B1.G102-0992.2	G2108104	B1.G208-0104.1
G1020745	B1.G102-0745.2	G1020858	B1.G102-0858.2	G1020993	B1.G102-0993.2	G2108106	B1.G208-0106.1
G1020746	B1.G102-0746.2	G1020859	B1.G102-0859.2	G1020994	B1.G102-0994.2	G2108107	B1.G208-0107.1
G1020751	B1.G102-0751.2	G1020860	B1.G102-0860.2	G1020995	B1.G102-0995.2	G2108108	B1.G208-0108.1
G1020752	B1.G102-0752.2	G1020862	B1.G102-0862.2	G1020999	B1.G102-0999.2	G2108109	B1.G208-0109.1
G1020753	B1.G102-0753.2	G1020866	B1.G102-0866.2	G1201000	B1.G120-1000.2	G2108113	B1.G208-0113.1
G1020754	B1.G102-0754.2	G1020867	B1.G102-0867.2	G1201002	B1.G120-1002.2	G2109114	B1.G209-0114.1
G1020755	B1.G102-0755.2	G1020871	B1.G102-0871.2	G1201004	B1.G120-1004.2	G2109120	B1.G209-0120.1
G1020756	B1.G102-0756.2	G1020872	B1.G102-0872.2	G1201005	B1.G120-1005.2	G2109123	B1.G209-0123.1
G1020758	B1.G102-0758.2	G1020873	B1.G102-0873.2	G1201009	B1.G120-1009.2	G2109124	B1.G209-0124.1
G1020759	B1.G102-0759.2	G1020874	B1.G102-0874.2	G1201010	B1.G120-1010.2	G2109133	B1.G209-0133.1
G1020761	B1.G102-0761.2	G1020875	B1.G102-0875.2	G1201011	B1.G120-1011.2	G2109136	B1.G209-0136.1
G1020762	B1.G102-0762.2	G1020876	B1.G102-0876.2	G1201013	B1.G120-1013.2	G2109137	B1.G209-0137.1
G1020763	B1.G102-0763.2	G1020877	B1.G102-0877.2	G1201014	B1.G120-1014.2	G2109139	B1.G209-0139.1
G1020764	B1.G102-0764.2	G1020882	B1.G102-0882.2	G1201022	B1.G120-1022.2	G2109142	B1.G209-0142.1
G1020765	B1.G102-0765.2	G1020883	B1.G102-0883.2	G1201025	B1.G120-1025.2	G2109157	B1.G209-0157.1
G1020766	B1.G102-0766.2	G1020885	B1.G102-0885.2	G1201029	B1.G120-1029.2	G2110111	B1.G210-0111.1
G1020768	B1.G102-0768.2	G1020886	B1.G102-0886.2	G1201033	B1.G120-1033.2	G2110115	B1.G210-0115.1

# Cross reference list GALFER short → GALFER long

Liste des correspondances GALFER courte → GALFER longue / Tabella di conversione codici GALFER breve → GALFER lungo / Lista de comparação GALFER curto → GALFER longo / Lista porównawcza numerów GALFER krótki → GALFER długo / Porovnávací seznam čísel GALFER krátký → GALFER dlouho

 short / courte breve / curto krótki / krátky	 long / longue lungo / longo dlugo / dlouho	 short / courte breve / curto krótki / krátky	 long / longue lungo / longo dlugo / dlouho	 short / courte breve / curto krótki / krátky	 long / longue lungo / longo dlugo / dlouho	 short / courte breve / curto krótki / krátky	 long / longue lungo / longo dlugo / dlouho
G2110151	B1.G210-0151.1	G2113181	B1.G213-0181.1	G2122270	B1.G222-0270.1	G2130115	B1.G230-0115.1
G2110178	B1.G210-0178.1	G2113182	B1.G213-0182.1	G2123113	B1.G223-0113.1	G2130175	B1.G230-0175.1
G2110187	B1.G210-0187.1	G2113184	B1.G213-0184.1	G2124115	B1.G224-0115.1	G2130176	B1.G230-0176.1
G2110190	B1.G210-0190.1	G2113185	B1.G213-0185.1	G2124120	B1.G224-0120.1	G2132114	B1.G232-0114.1
G2110196	B1.G210-0196.1	G2113195	B1.G213-0195.1	G2124127	B1.G224-0127.1	G2132115	B1.G232-0115.1
G2110201	B1.G210-0201.1	G2115105	B1.G215-0105.1	G2124131	B1.G224-0131.1	G2132144	B1.G232-0144.1
G2110202	B1.G210-0202.1	G2116123	B1.G216-0123.1	G2124138	B1.G224-0138.1	G2132153	B1.G232-0153.1
G2110209	B1.G210-0209.1	G2116124	B1.G216-0124.1	G2124152	B1.G224-0152.1	G2134100	B1.G234-0100.1
G2110210	B1.G210-0210.1	G2118106	B1.G218-0106.1	G2124158	B1.G224-0158.1		
G2110211	B1.G210-0211.1	G2118131	B1.G218-0131.1	G2124161	B1.G224-0161.1		
G2110212	B1.G210-0212.1	G2118137	B1.G218-0137.1	G2124166	B1.G224-0166.1		
G2110213	B1.G210-0213.1	G2118145	B1.G218-0145.1	G2124169	B1.G224-0169.1		
G2110215	B1.G210-0215.1	G2119107	B1.G219-0107.1	G2124171	B1.G224-0171.1		
G2110217	B1.G210-0217.1	G2119108	B1.G219-0108.1	G2124191	B1.G224-0191.1		
G2110223	B1.G210-0223.1	G2120115	B1.G220-0115.1	G2124197	B1.G224-0197.1		
G2110225	B1.G210-0225.1	G2120123	B1.G220-0123.1	G2124221	B1.G224-0221.1		
G2110229	B1.G210-0229.1	G2120125	B1.G220-0125.1	G2124222	B1.G224-0222.1		
G2110230	B1.G210-0230.1	G2120128	B1.G220-0128.1	G2125105	B1.G225-0105.1		
G2110232	B1.G210-0232.1	G2120132	B1.G220-0132.1	G2125110	B1.G225-0110.1		
G2110250	B1.G210-0250.1	G2120133	B1.G220-0133.1	G2125113	B1.G225-0113.1		
G2110251	B1.G210-0251.1	G2120140	B1.G220-0140.1	G2125114	B1.G225-0114.1		
G2110258	B1.G210-0258.1	G2120142	B1.G220-0142.1	G2125115	B1.G225-0115.1		
G2110261	B1.G210-0261.1	G2120146	B1.G220-0146.1	G2125117	B1.G225-0117.1		
G2110271	B1.G210-0271.1	G2120147	B1.G220-0147.1	G2125119	B1.G225-0119.1		
G2110277	B1.G210-0277.1	G2120155	B1.G220-0155.1	G2125123	B1.G225-0123.1		
G2110278	B1.G210-0278.1	G2120174	B1.G220-0174.1	G2125124	B1.G225-0124.1		
G2110285	B1.G210-0285.1	G2120175	B1.G220-0175.1	G2125131	B1.G225-0131.1		
G2110302	B1.G210-0302.1	G2120180	B1.G220-0180.1	G2125137	B1.G225-0137.1		
G2110312	B1.G210-0312.1	G2120184	B1.G220-0184.1	G2125138	B1.G225-0138.1		
G2110324	B1.G210-0324.1	G2120195	B1.G220-0195.1	G2125141	B1.G225-0141.1		
G2110356	B1.G210-0356.1	G2120204	B1.G220-0204.1	G2125142	B1.G225-0142.1		
G2111145	B1.G211-0145.1	G2120211	B1.G220-0211.1	G2125145	B1.G225-0145.1		
G2111152	B1.G211-0152.1	G2121105	B1.G221-0105.1	G2125148	B1.G225-0148.1		
G2111154	B1.G211-0154.1	G2121106	B1.G221-0106.1	G2125149	B1.G225-0149.1		
G2111155	B1.G211-0155.1	G2122115	B1.G222-0115.1	G2125155	B1.G225-0155.1		
G2111158	B1.G211-0158.1	G2122145	B1.G222-0145.1	G2125158	B1.G225-0158.1		
G2111164	B1.G211-0164.1	G2122147	B1.G222-0147.1	G2125162	B1.G225-0162.1		
G2112106	B1.G212-0106.1	G2122148	B1.G222-0148.1	G2125165	B1.G225-0165.1		
G2112116	B1.G212-0116.1	G2122150	B1.G222-0150.1	G2125170	B1.G225-0170.1		
G2112126	B1.G212-0126.1	G2122151	B1.G222-0151.1	G2125171	B1.G225-0171.1		
G2112127	B1.G212-0127.1	G2122152	B1.G222-0152.1	G2125184	B1.G225-0184.1		
G2112131	B1.G212-0131.1	G2122159	B1.G222-0159.1	G2125198	B1.G225-0198.1		
G2112137	B1.G212-0137.1	G2122160	B1.G222-0160.1	G2125199	B1.G225-0199.1		
G2112138	B1.G212-0138.1	G2122161	B1.G222-0161.1	G2126106	B1.G226-0106.1		
G2112141	B1.G212-0141.1	G2122163	B1.G222-0163.1	G2126120	B1.G226-0120.1		
G2112144	B1.G212-0144.1	G2122172	B1.G222-0172.1	G2126150	B1.G226-0150.1		
G2112154	B1.G212-0154.1	G2122194	B1.G222-0194.1	G2126154	B1.G226-0154.1		
G2112155	B1.G212-0155.1	G2122197	B1.G222-0197.1	G2128125	B1.G228-0125.1		
G2112157	B1.G212-0157.1	G2122204	B1.G222-0204.1	G2128132	B1.G228-0132.1		
G2112158	B1.G212-0158.1	G2122210	B1.G222-0210.1	G2128142	B1.G228-0142.1		
G2112162	B1.G212-0162.1	G2122211	B1.G222-0211.1	G2128154	B1.G228-0154.1		
G2112169	B1.G212-0169.1	G2122216	B1.G222-0216.1	G2128164	B1.G228-0164.1		
G2112171	B1.G212-0171.1	G2122231	B1.G222-0231.1	G2128176	B1.G228-0176.1		
G2112178	B1.G212-0178.1	G2122232	B1.G222-0232.1	G2128177	B1.G228-0177.1		
G2112184	B1.G212-0184.1	G2122238	B1.G222-0238.1	G2128203	B1.G228-0203.1		
G2113161	B1.G213-0161.1	G2122240	B1.G222-0240.1	G2130113	B1.G230-0113.1		
G2113178	B1.G213-0178.1	G2122258	B1.G222-0258.1	G2130114	B1.G230-0114.1		



**CONTINENTAL AFTERMARKET GMBH**

Guerickestraße 7 | 60488 Frankfurt/Main (Germany) | Phone: +49 69 7603-11 | Fax: +49 69 7610-61  
info@galfer-aftermarket.com | www.galfer-aftermarket.com

